

TABLE OF CONTENTS

1	Before driving	Adjusting and operating features such as door locks, mirrors, and steering column.
2	When driving	Driving, stopping and safe-driving information.
3	Interior features	Air conditioning and audio systems, as well as other interior features for a comfortable driving experience.
4	Maintenance and care	Cleaning and protecting your vehicle, performing do-it-yourself maintenance, and maintenance information.
5	When trouble arises	What to do if the vehicle needs to be towed, gets a flat tire, or is involved in an accident.
6	Vehicle specifications	Detailed vehicle information.
	Index	Alphabetical listing of information contained in this manual.

1 Before driving

1-1. Key information
 Keys 40

1-2. Opening, closing and locking the doors
 Smart entry & start system ... 44
 Wireless remote control 61
 Side doors..... 67
 Back door..... 71

1-3. Adjustable components (seats, mirrors, steering wheel)
 Front seats 76
 Rear seats 79
 Head restraints 82
 Seat belts 84
 Steering wheel 91
 Anti-glare inside rear view mirror 92
 Outside rear view mirrors..... 94

1-4. Opening and closing the windows
 Power windows 97

1-5. Refueling
 Opening the fuel tank cap... 100

1-6. Theft deterrent system
 Engine immobilizer system 104
 Double locking system..... 107

1-7. Safety information

Correct driving posture..... 109
 SRS airbags 111
 Airbag manual on-off system..... 122
 Child restraint systems 125
 Installing child restraints..... 134

2 When driving

2-1. Driving procedures

Driving the vehicle 148
 Engine (ignition) switch (vehicles without a smart entry & start system) 165
 Engine (ignition) switch (vehicles with a smart entry & start system) 169
 Multidrive 179
 Multi-mode manual transmission 185
 Manual transmission 190
 Turn signal lever..... 194
 Parking brake 195
 Horn 196

2-2. Instrument cluster

Gauges and meters..... 197
 Indicators and warning lights..... 201
 Multi-information display 208

2-3. Operating the lights and wipers

Headlight switch..... 214
Fog light switch 220
Windshield wiper and washer 222
Rear window wiper and washer 226

2-4. Using other driving systems

Cruise control..... 228
Speed limiter..... 232
Stop & Start system..... 235
Driving assist systems 243
Diesel particulate filter system 248

2-5. Driving information

Cargo and luggage 250
Winter driving tips 252
Trailer towing (except for South Africa)..... 256

3 Interior features

3-1. Using the air conditioning system and defogger

Manual air conditioning system 268
Automatic air conditioning system 275
Power heater 283
Rear window and outside rear view mirror defoggers..... 285

3-2. Using the audio system

Audio system types 287
Using the radio 292
Using the CD player 296
Playing back MP3 and WMA discs 301
Operating an iPod 307
Operating a USB memory 315
Optimal use of the audio system..... 322
Using the AUX port 324
Using the steering wheel audio switches 325

3-3. Using the interior lights

Interior lights list 328
• Personal lights 329
• Interior light 329

3-4. Using the storage features

List of storage features..... 331
• Glove box..... 332
• Cup holders..... 333
• Bottle holders 334

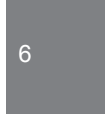

3-5. Other interior features

Sun visors 336
 Vanity mirrors..... 337
 Clock..... 338
 Outside temperature
 display 339
 Portable ashtray..... 340
 Cigarette lighter 341
 Power outlet..... 342
 Seat heaters 343
 Armrest 345
 Panoramic roof shade..... 346
 Floor mat..... 347
 Luggage compartment
 features..... 349

4-3. Do-it-yourself maintenance

Do-it-yourself service
 precautions 365
 Hood..... 368
 Positioning a floor jack 370
 Engine compartment..... 373
 Tires 390
 Tire inflation pressure..... 394
 Wheels 396
 Air conditioning filter..... 398
 Wireless remote control/
 electronic key battery 401
 Checking and replacing
 fuses 405
 Light bulbs..... 422

4 Maintenance and care

4-1. Maintenance and care

Cleaning and protecting
 the vehicle exterior 354
 Cleaning and protecting
 the vehicle interior 359

4-2. Maintenance

Maintenance
 requirements..... 362

5 When trouble arises

5-1. Essential information

Emergency flashers 434
 If your vehicle needs to
 be towed 435
 If you think something is
 wrong 442
 Fuel pump shut off system
 (gasoline engine only)..... 443

5-2. Steps to take in an emergency

If a warning light turns on or a warning buzzer sounds.....	444
If you have a flat tire (vehicles with a spare tire)	459
If you have a flat tire (vehicles with an emergency tire puncture repair kit).....	471
If the engine will not start	488
If the shift lever cannot be shifted from P (vehicles with a Multidrive).....	491
If the shift lever cannot be shifted (vehicles with a multi-mode manual transmission)	492
If you lose your keys	493
If the electronic key does not operate properly (vehicles with a smart entry & start system).....	494
If the vehicle battery is discharged	498
If your vehicle overheats.....	505
If you run out of fuel and the engine stalls (diesel engine only)	509
If the vehicle becomes stuck	512
If your vehicle has to be stopped in an emergency	514

6 Vehicle specifications

6-1. Specifications

Maintenance data (fuel, oil level, etc.).....	518
Fuel information	539

6-2. Customization

Customizable features	542
-----------------------------	-----

Index

Abbreviation list.....	546
Alphabetical index	547
What to do if.....	555

1

2

3

4

5

6

3-door models

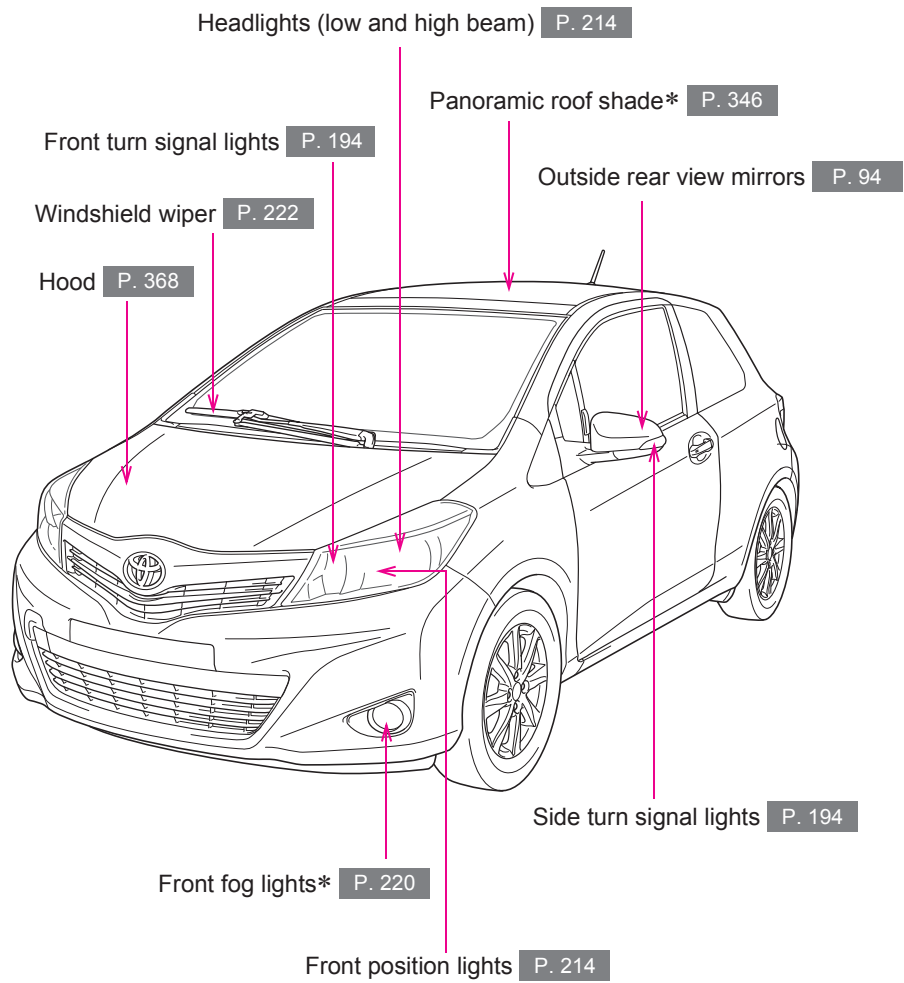

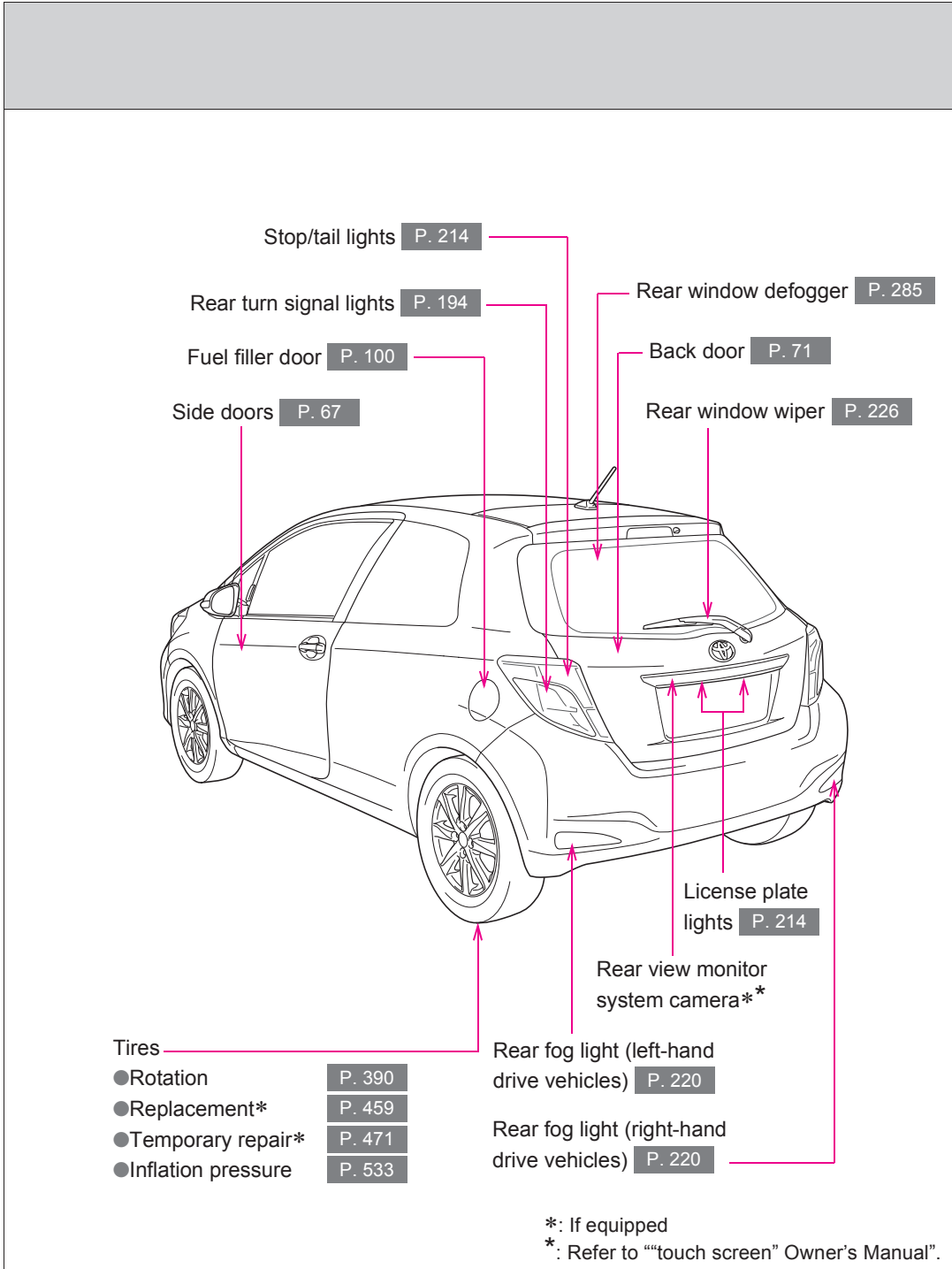

5-door models

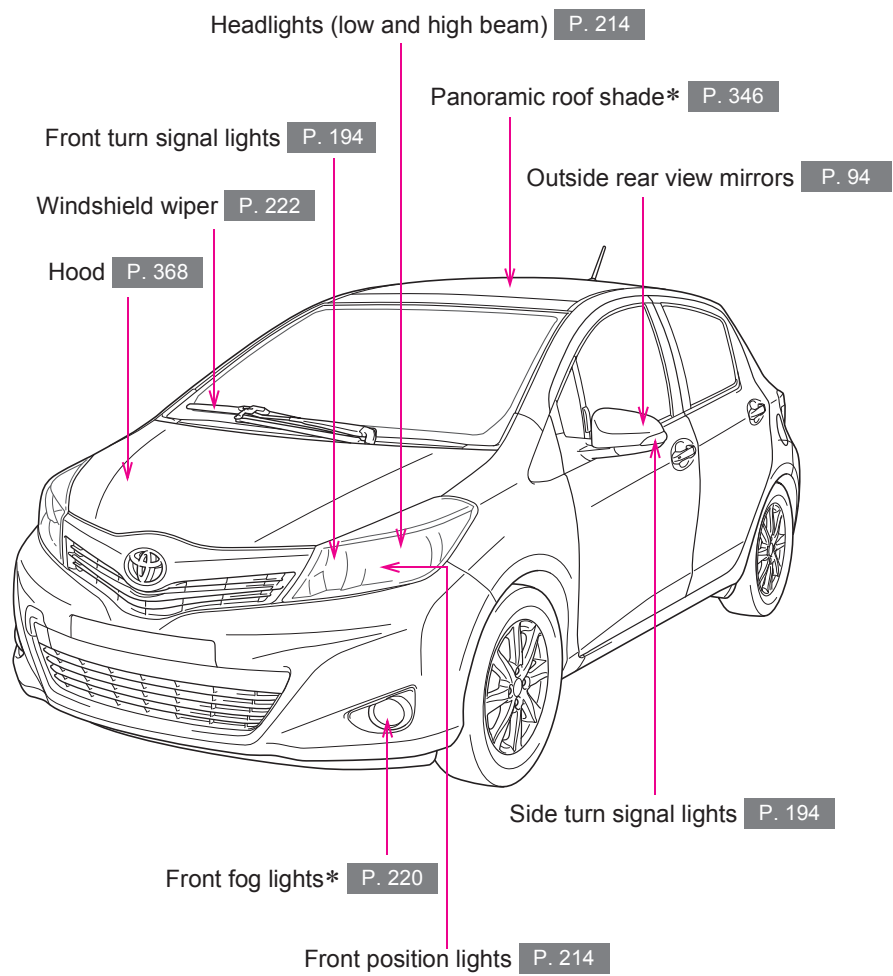

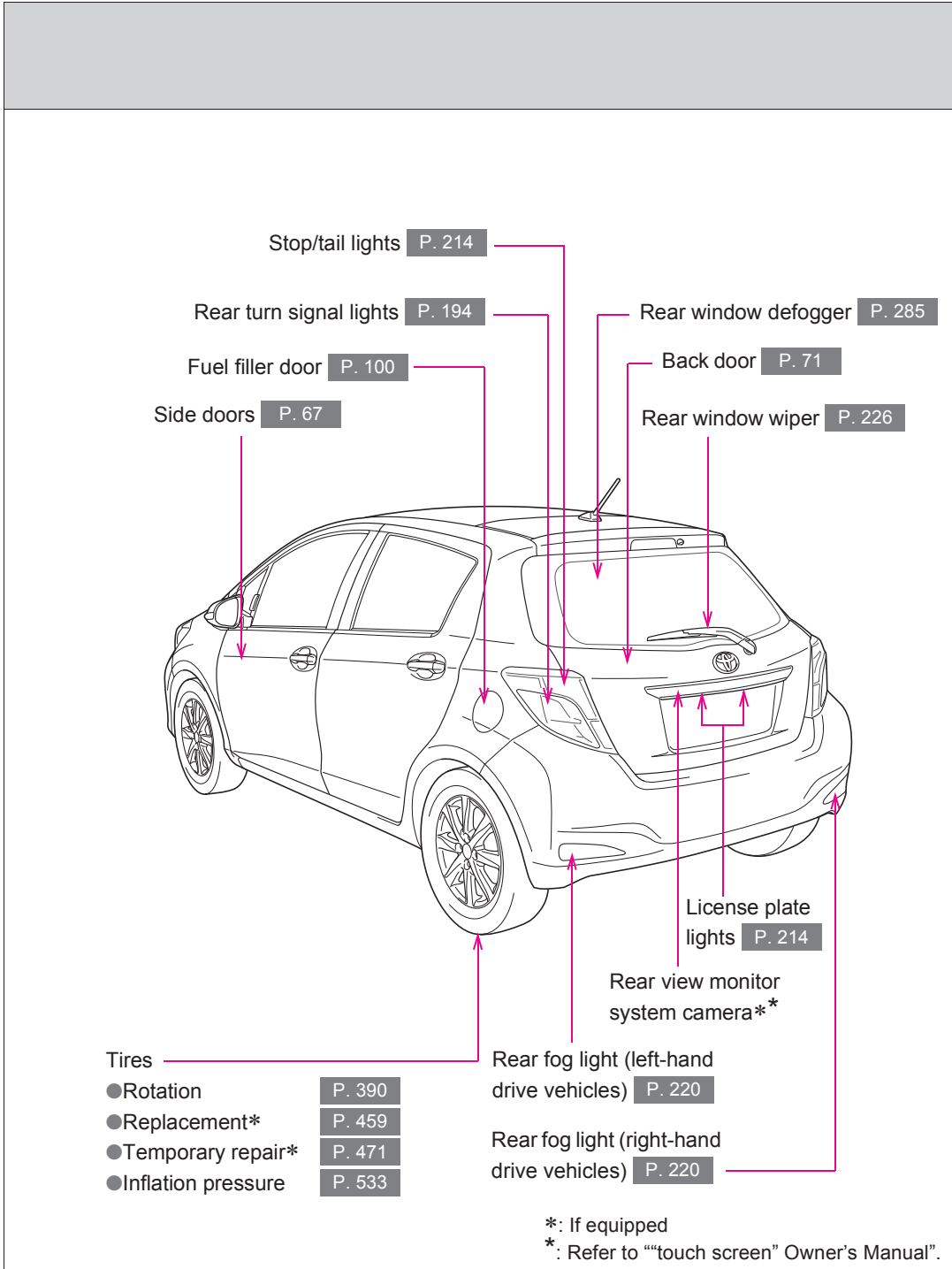

Pictorial index

Interior (Left-hand drive vehicles)

3-door models

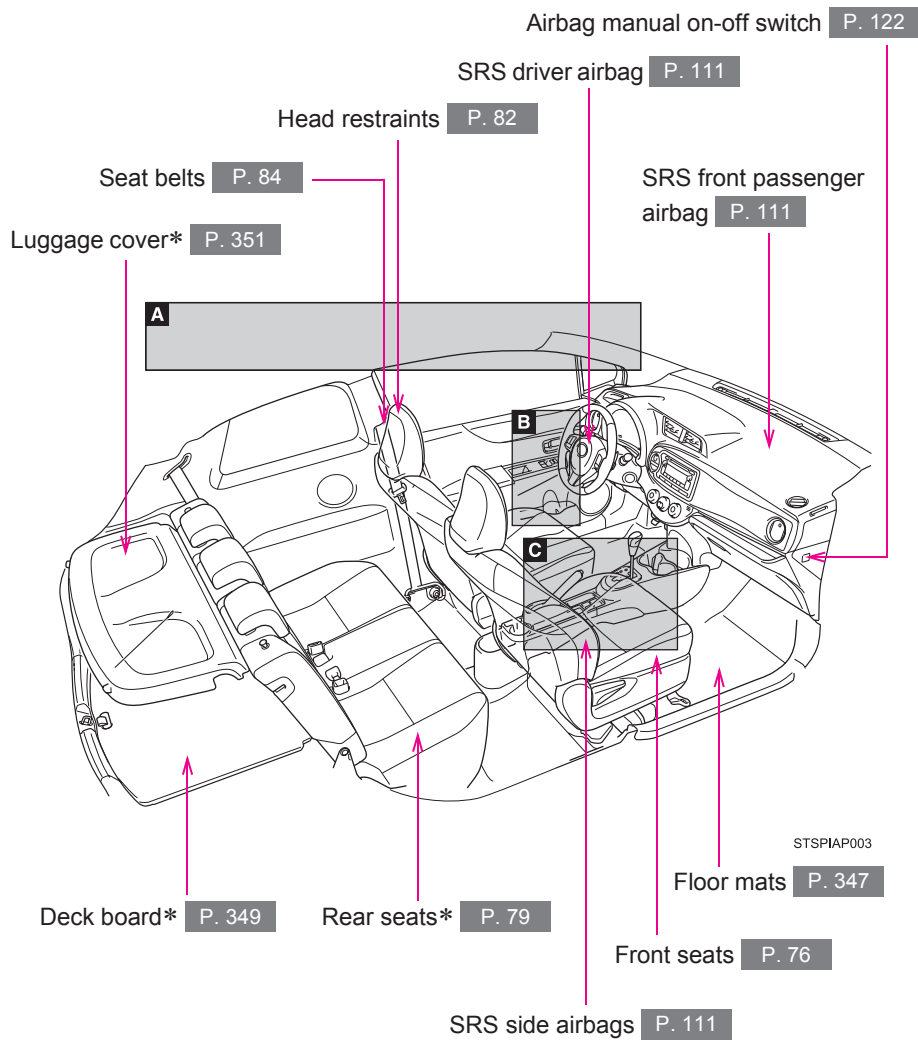

5-door models

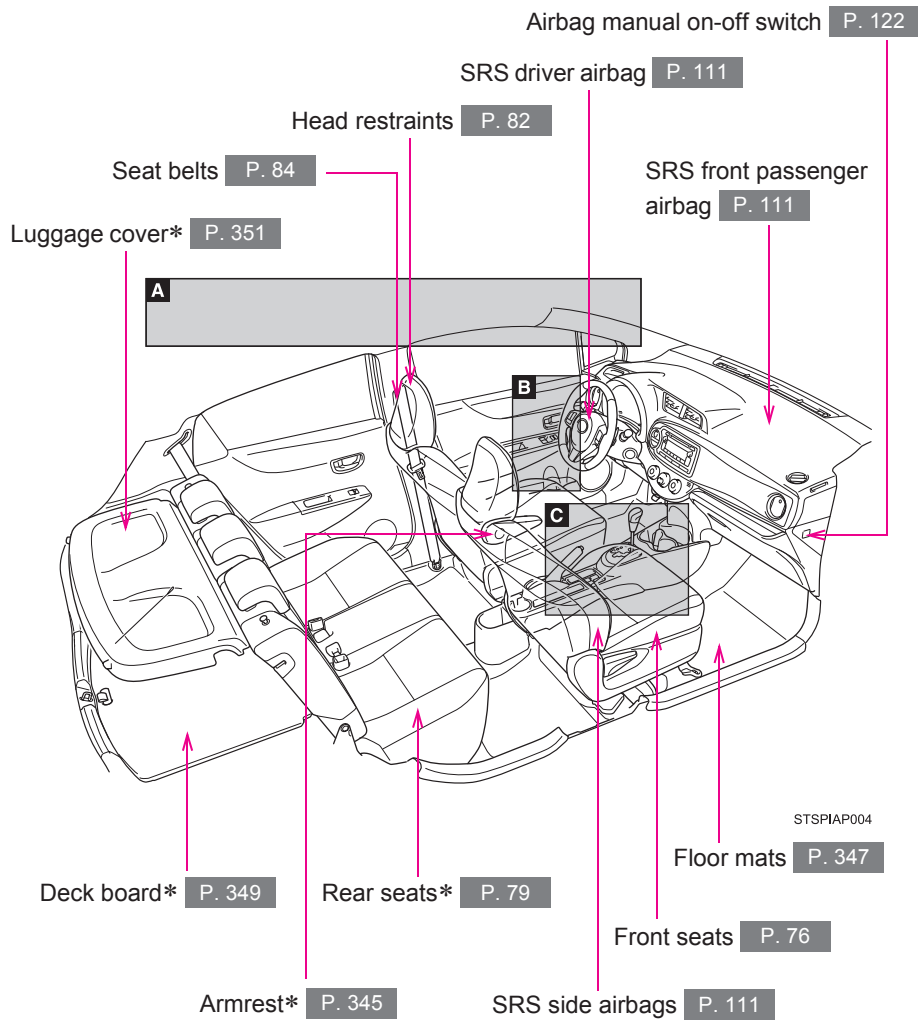

*: If equipped

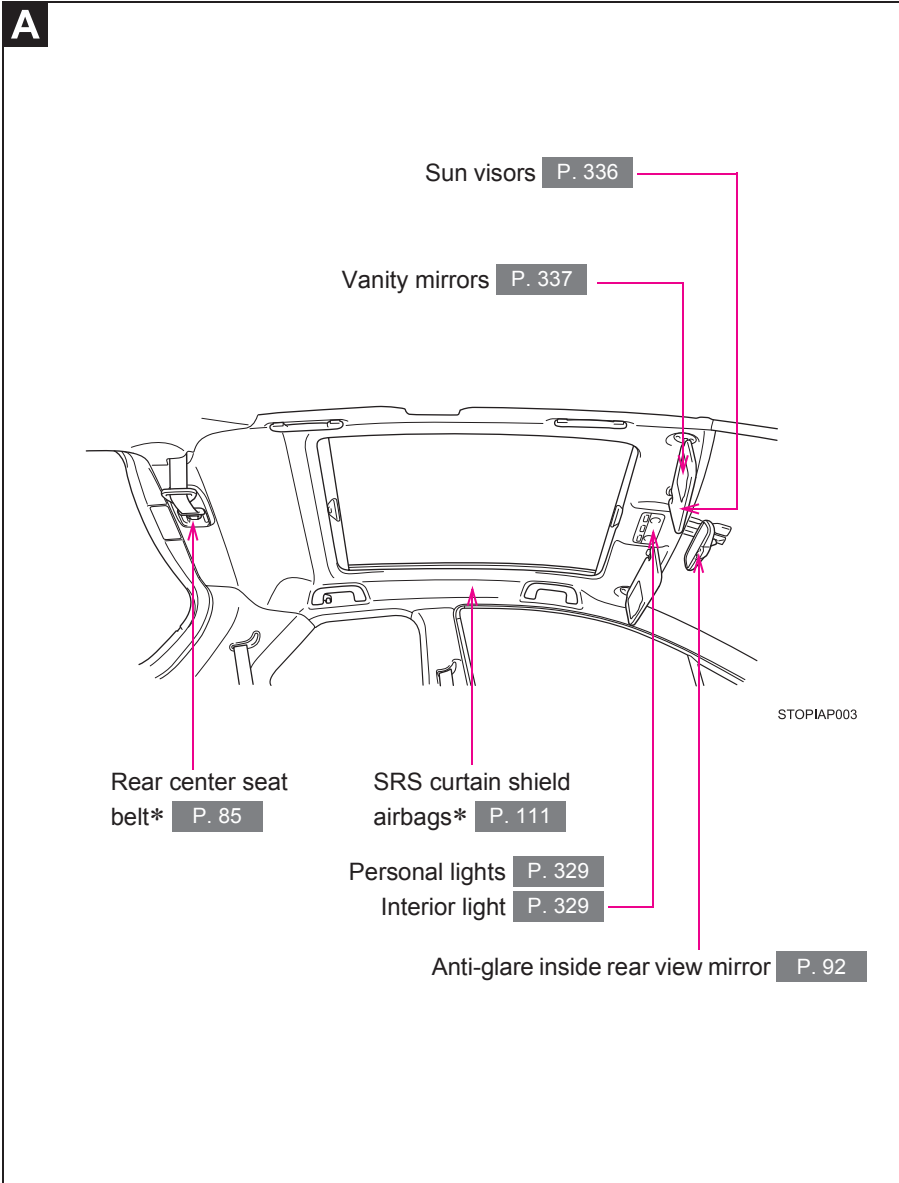

B

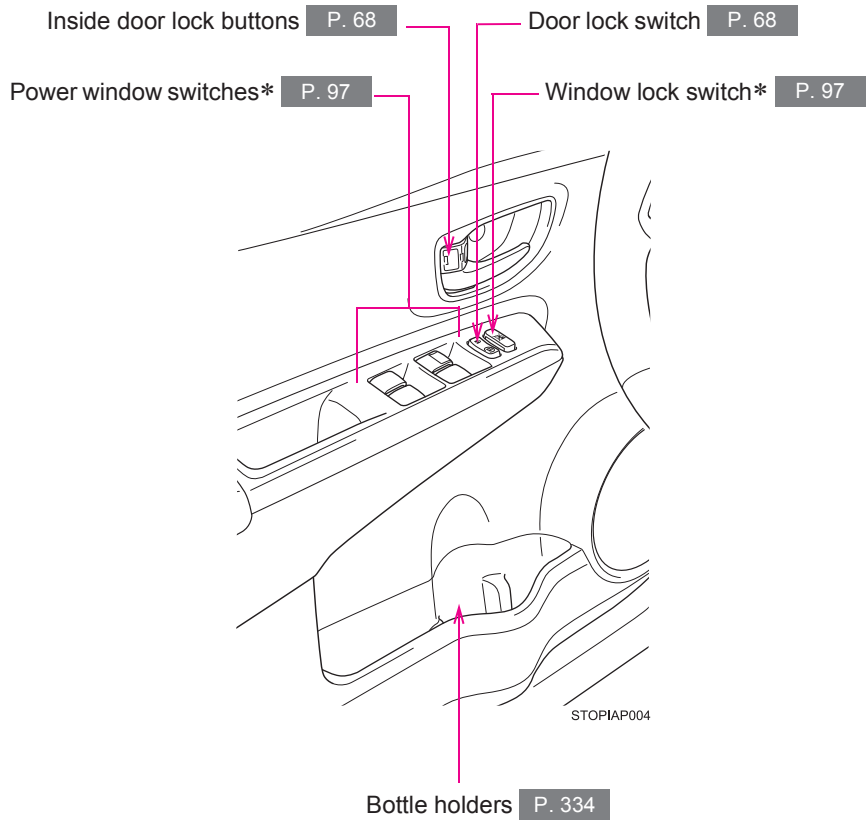

*: If equipped

Pictorial index

Interior (Left-hand drive vehicles)

C

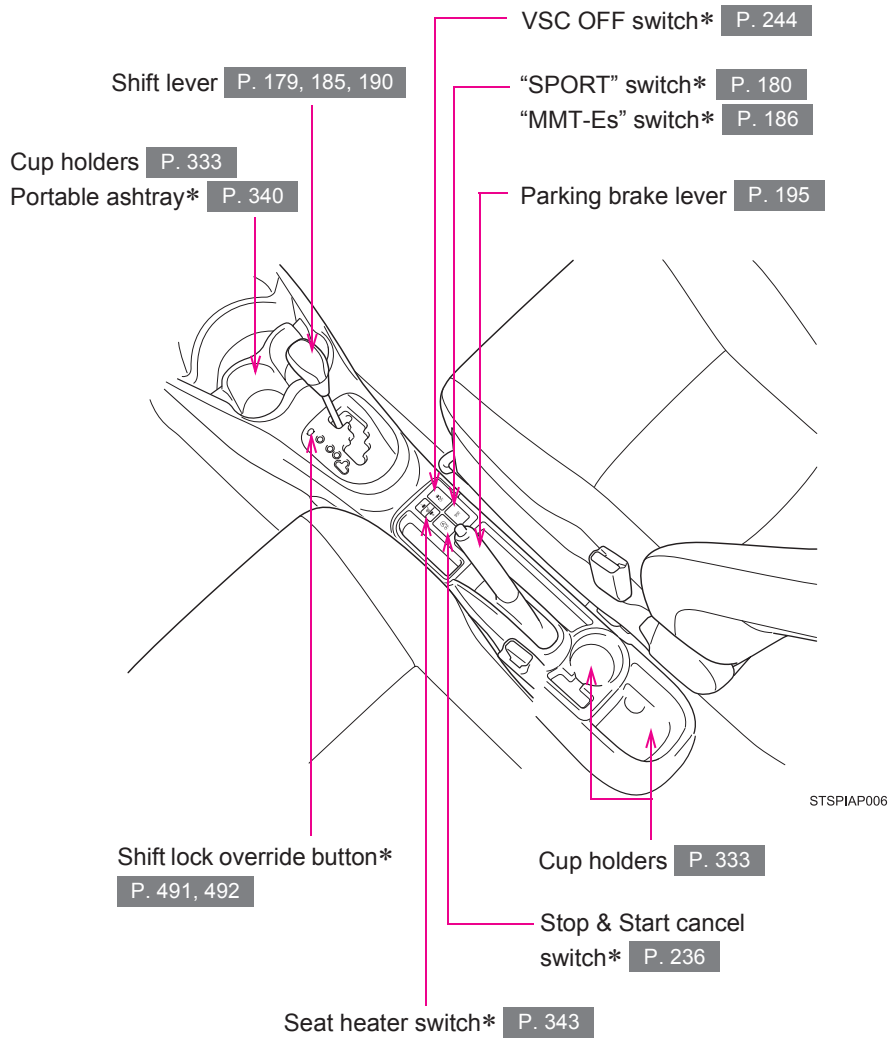

*: If equipped

Pictorial index

Instrument panel (Left-hand drive vehicles)

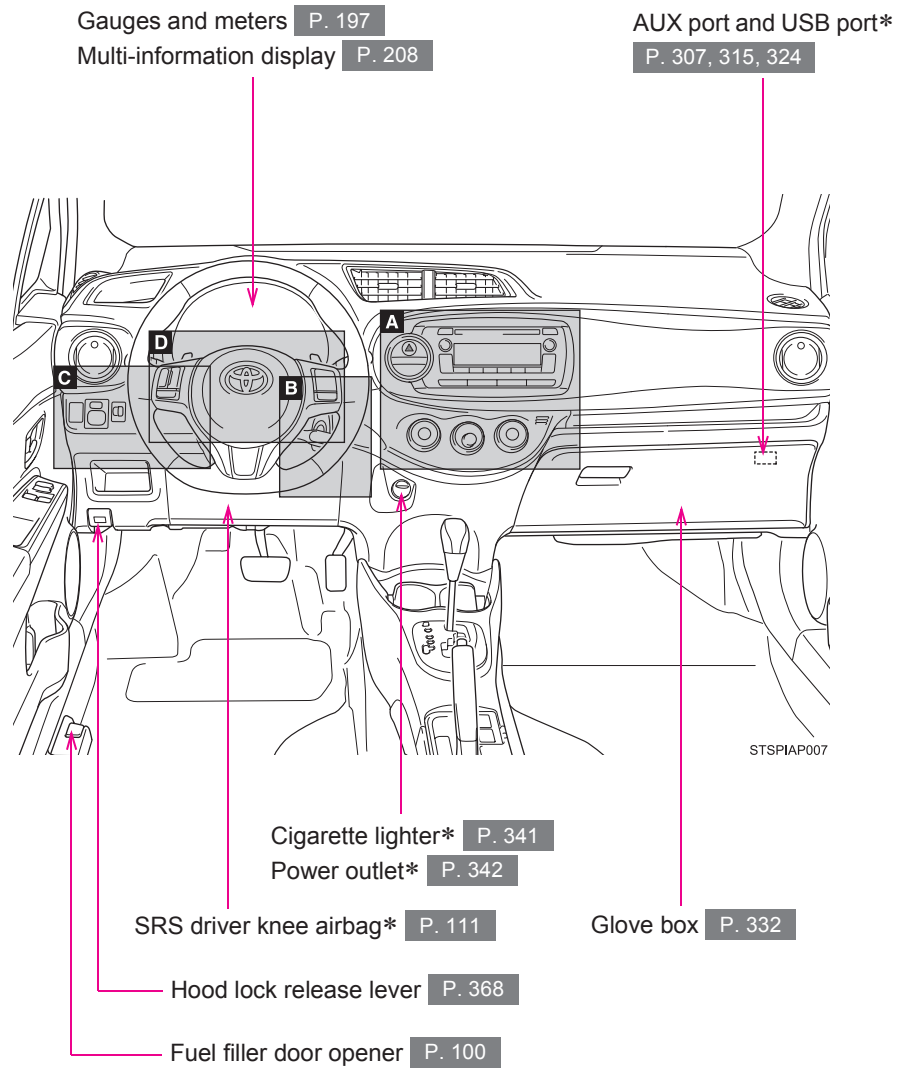

A

Vehicles with a manual air conditioning system

“PASSENGER AIR BAG” indicator P. 122

Emergency flasher switch P. 434

Audio system* P. 287
“touch screen”**

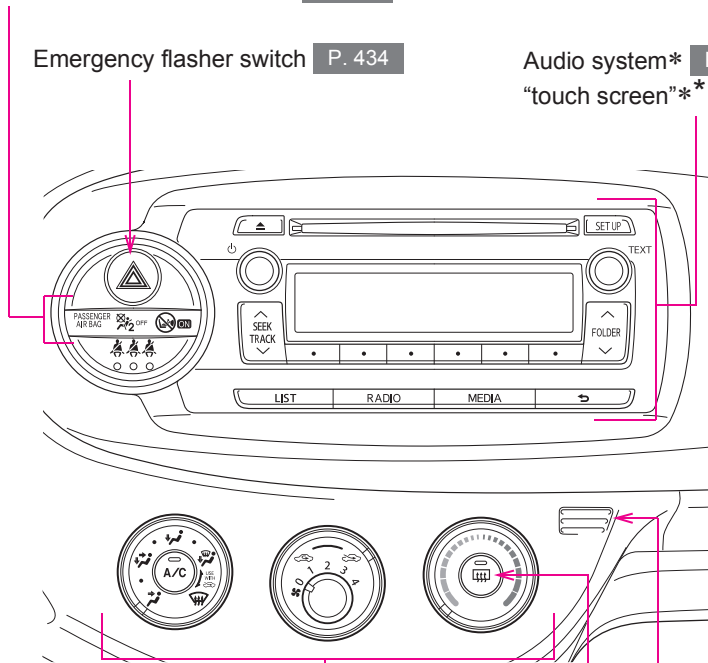

STSPIAP008

Air conditioning system P. 268

Microphone **

Rear window defogger switch*/
rear window defogger and outside
rear view mirror defoggers switch* P. 285

A

Vehicles with an automatic air conditioning system

“PASSENGER AIR BAG” indicator P. 122

Emergency flasher switch P. 434

Audio system* P. 287
“touch screen”**

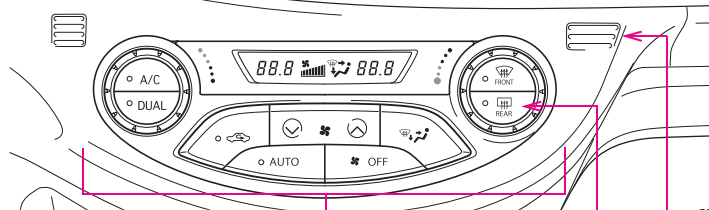
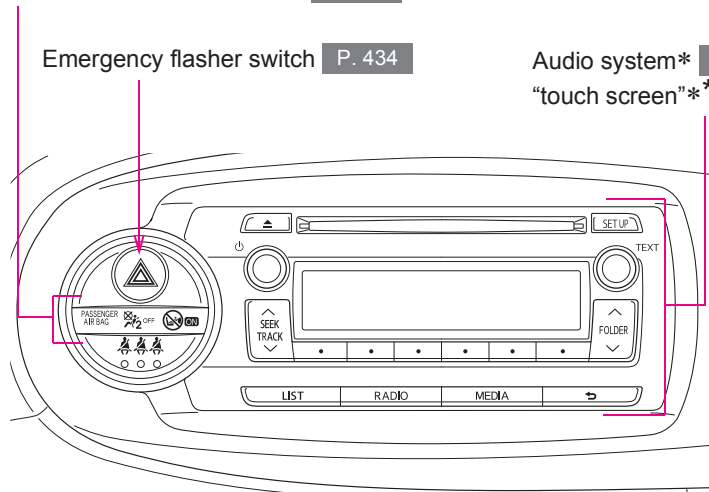

Air conditioning system P. 275

Microphone **

Rear window defogger switch*/
rear window defogger and outside rear
view mirror defoggers switch* P. 285

*: If equipped

** : Refer to “touch screen” Owner’s Manual”.

STOPIAP005

B

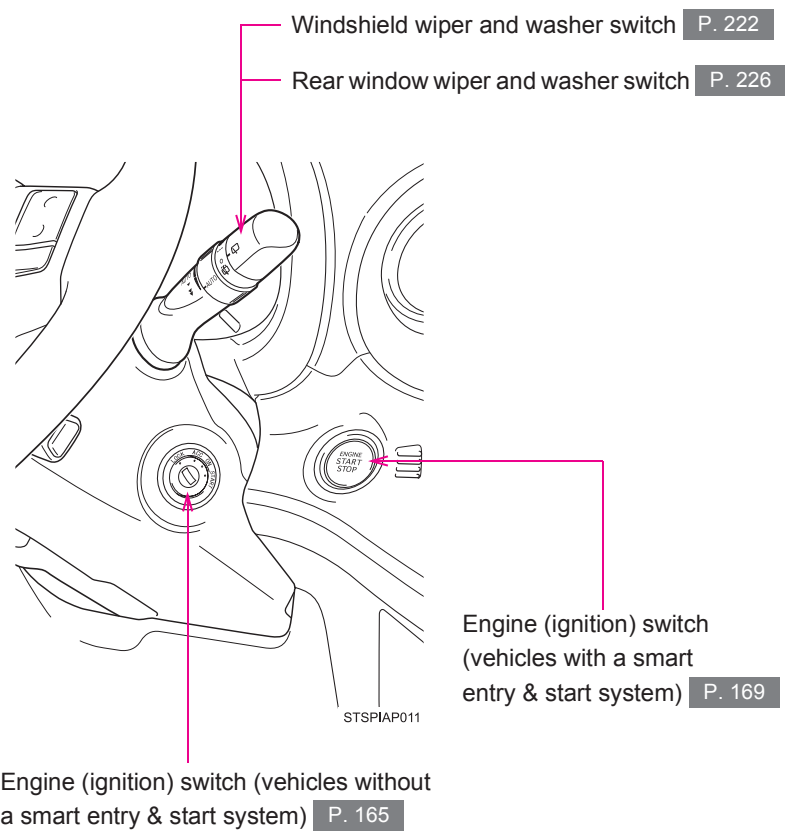

C

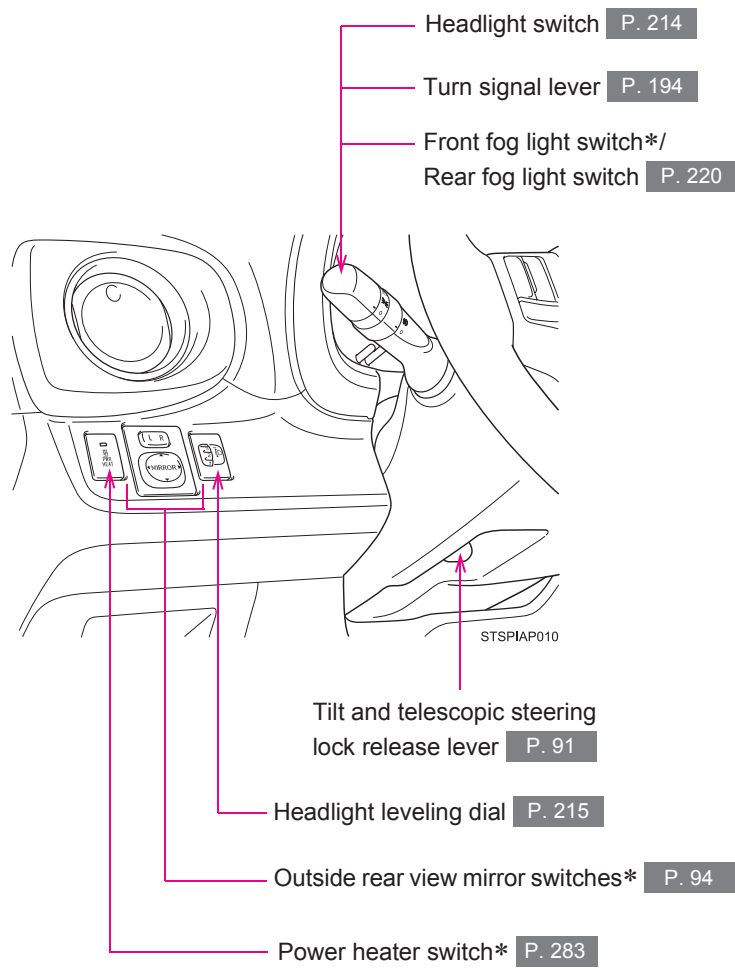

*: If equipped

D

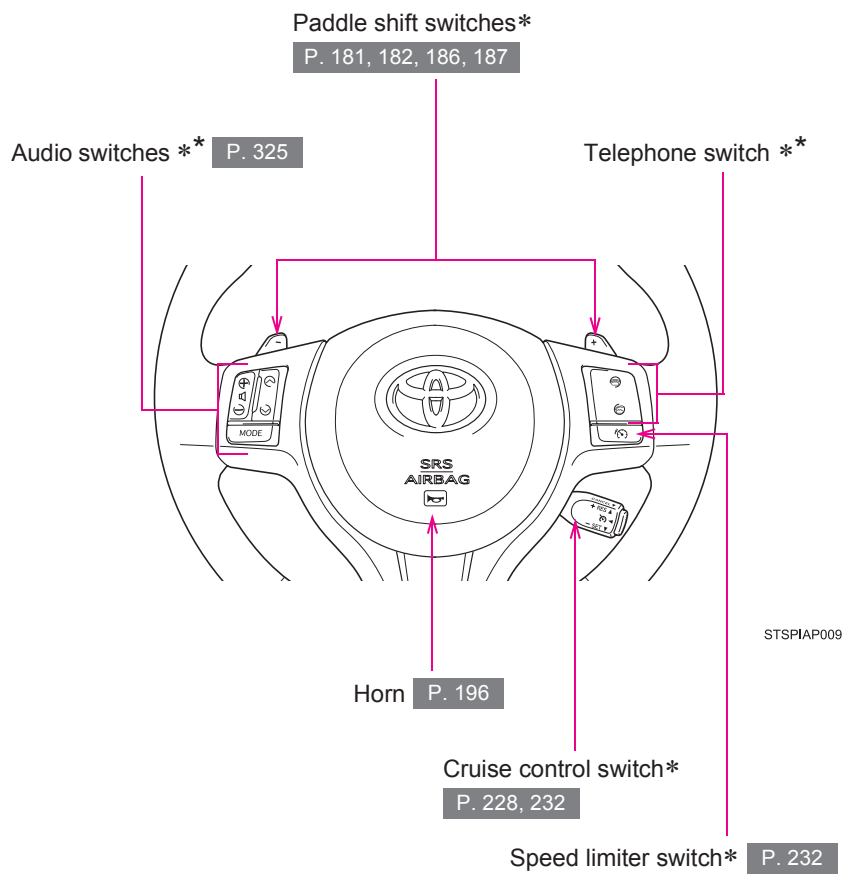

*: If equipped
*: Refer to ""touch screen" Owner's Manual".

3-door models

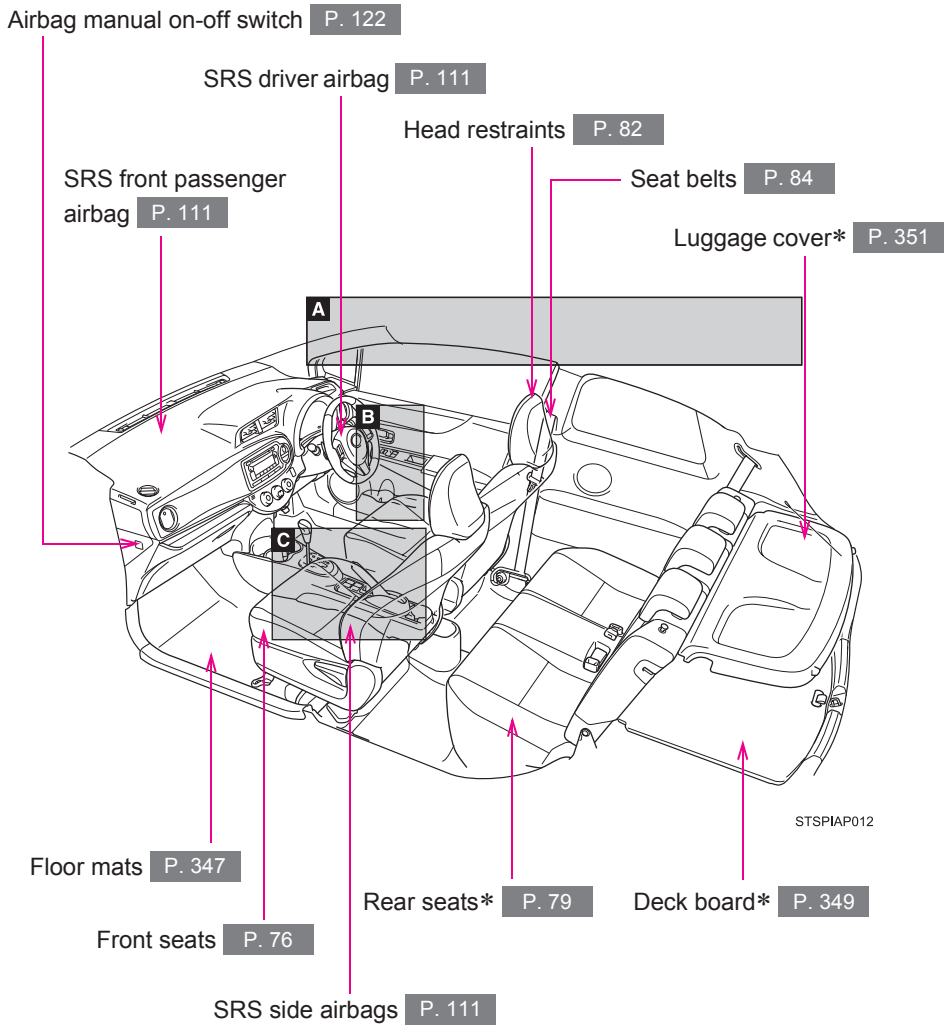

*: If equipped

Pictorial index

Interior (Right-hand drive vehicles)

5-door models

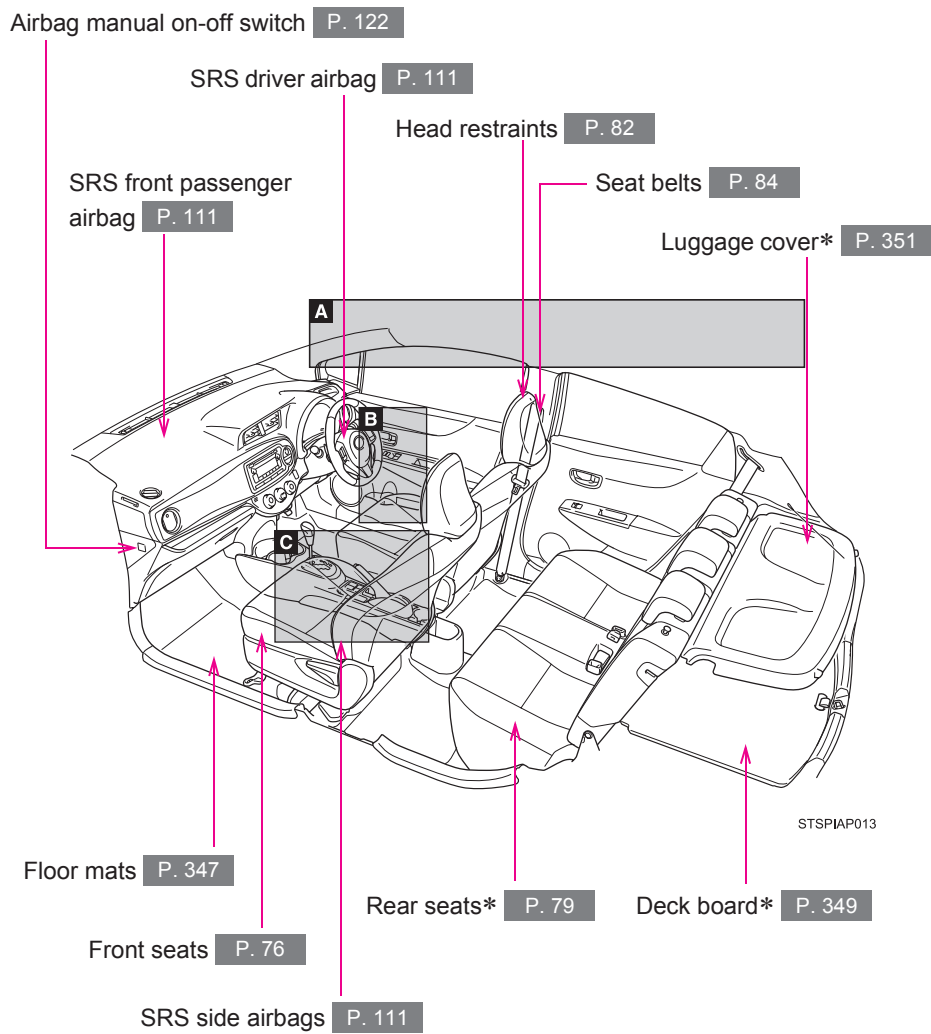

A

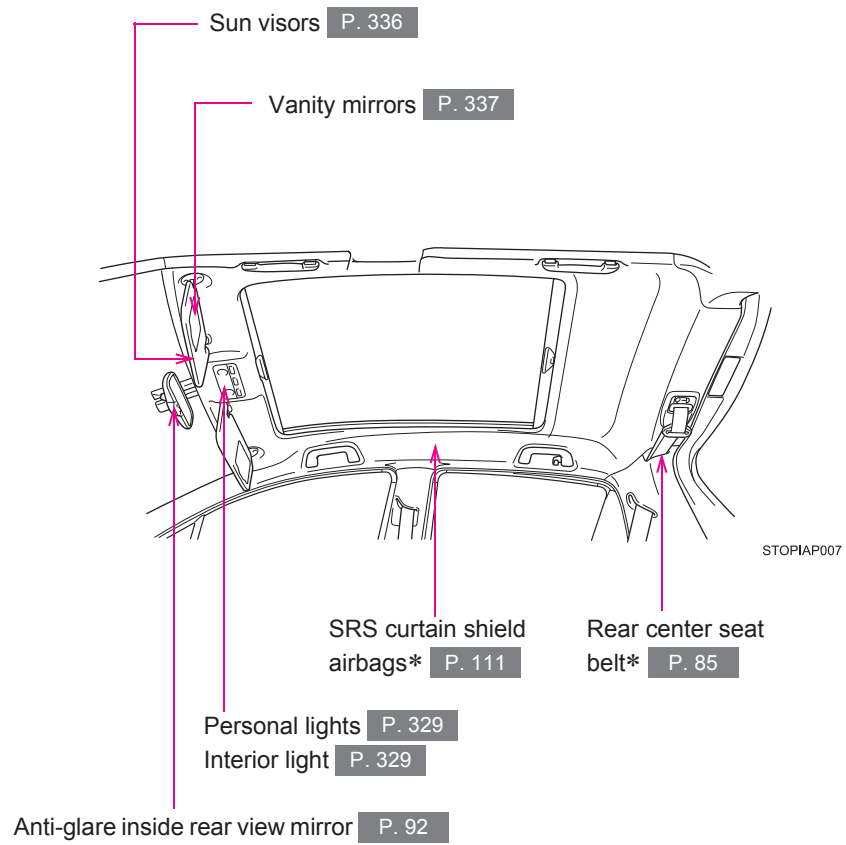

*: If equipped

B

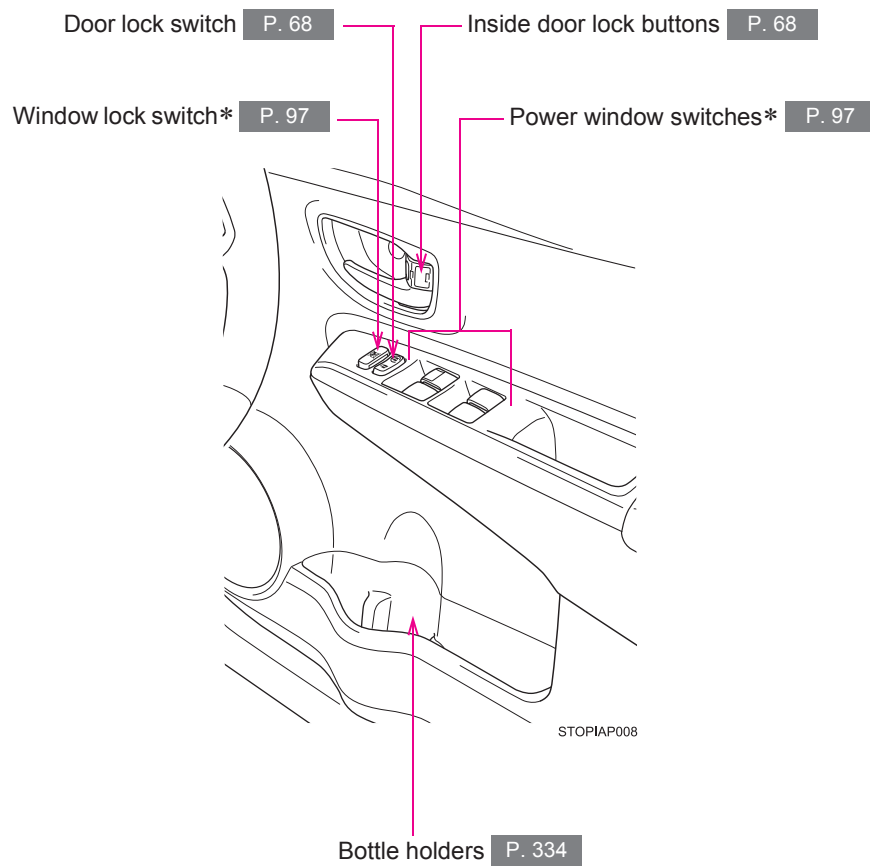

C

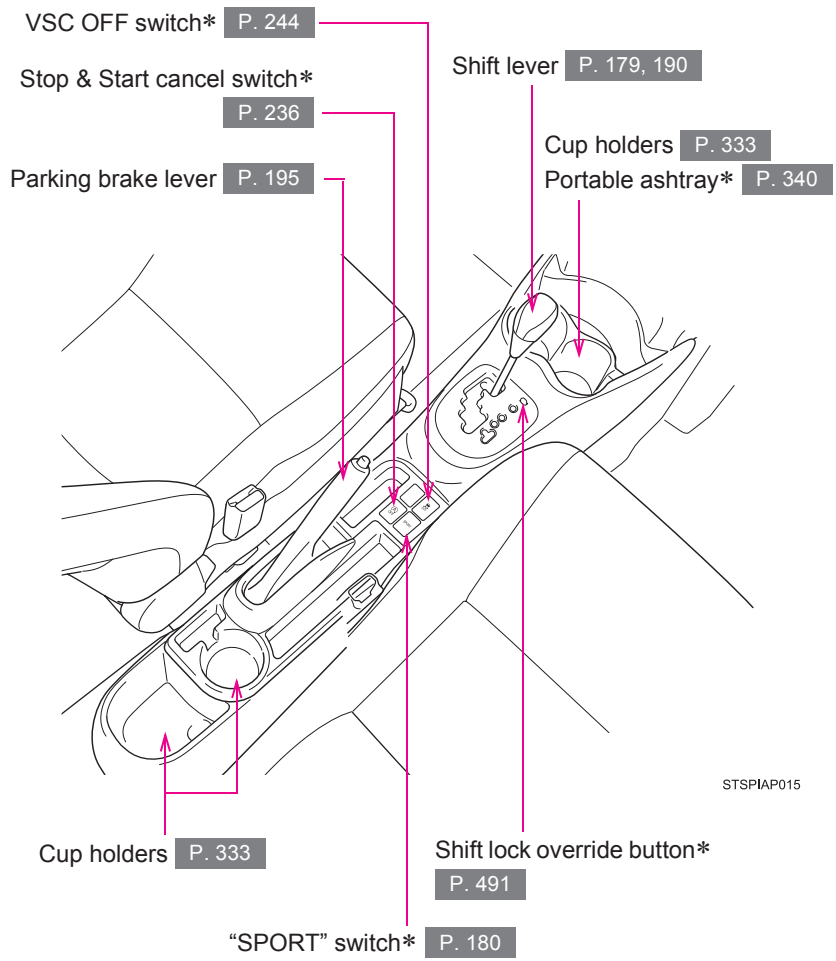

*: If equipped

Pictorial index

Instrument panel (Right-hand drive vehicles)

AUX port and USB port*
P. 307, 315, 324

Gauges and meters P. 197
Multi-information display P. 208

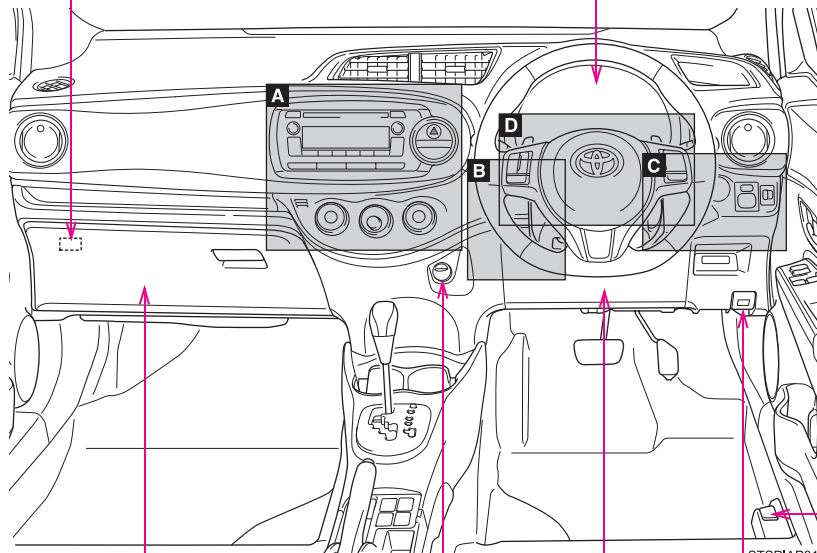

Glove box P. 332

Cigarette lighter* P. 341

Power outlet* P. 342

SRS driver knee airbag* P. 111

Hood lock release lever P. 368

Fuel filler door opener P. 100

A

Vehicles with a manual air conditioning system

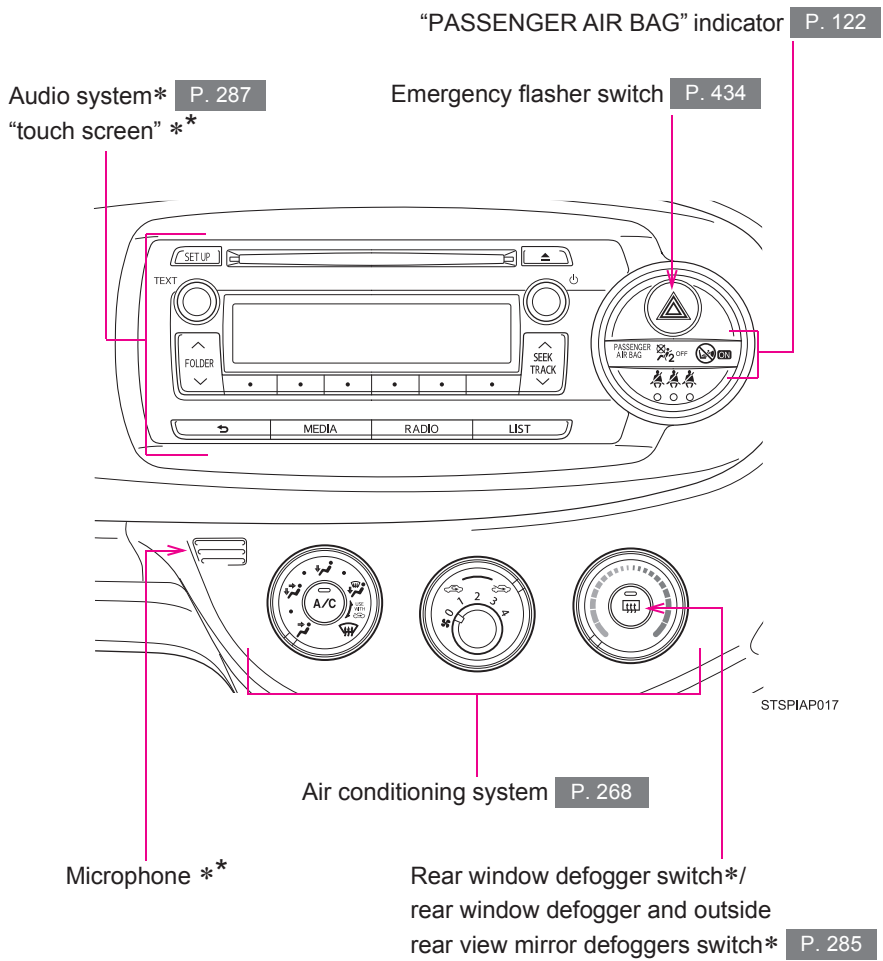

*: If equipped
*: Refer to "touch screen" Owner's Manual".

A

Vehicles with an automatic air conditioning system

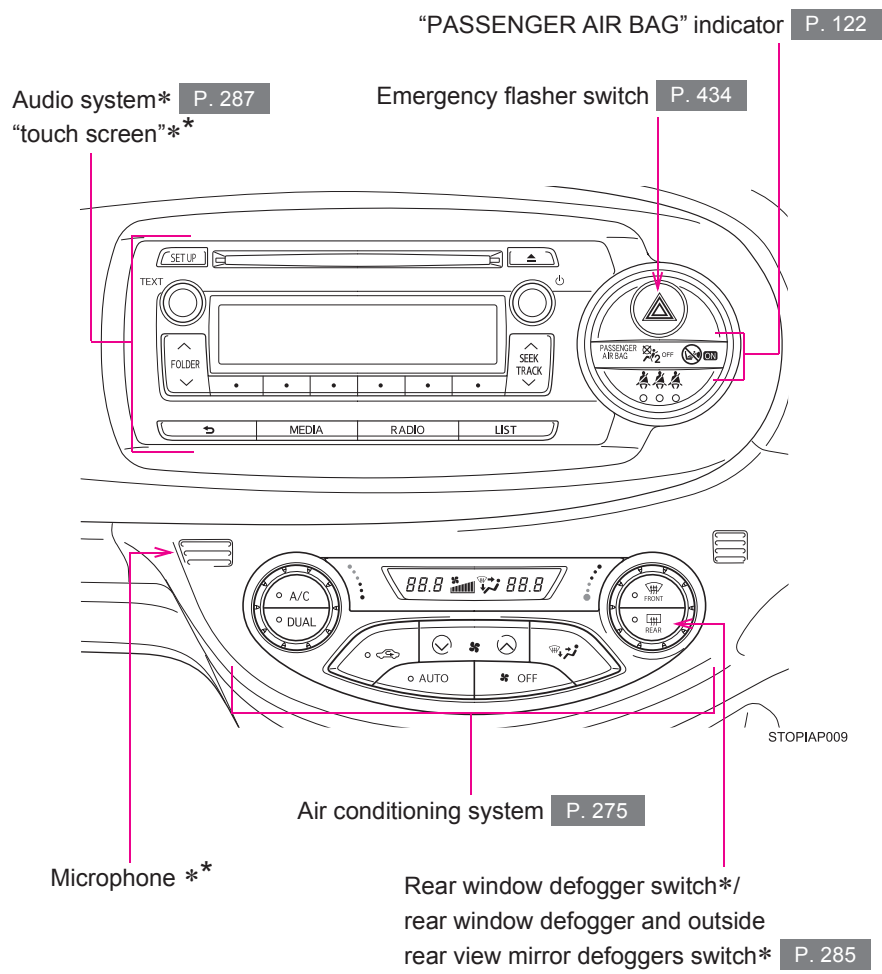

B

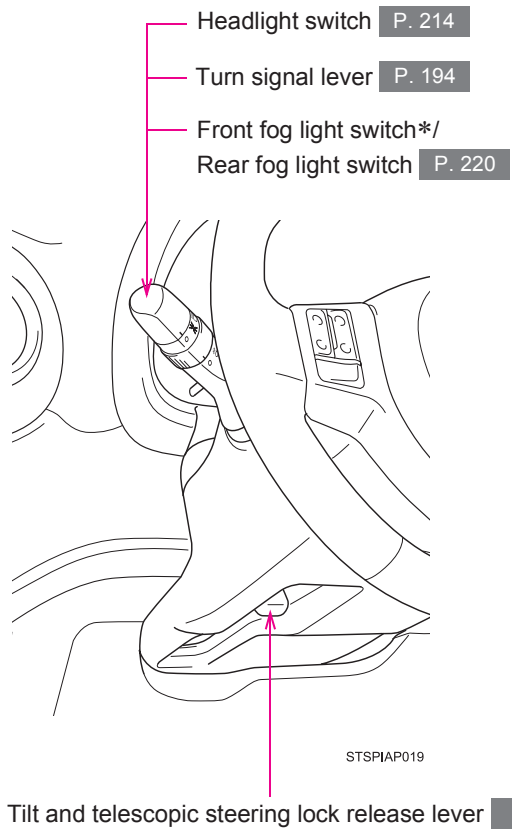

*: If equipped

*: Refer to ""touch screen" Owner's Manual".

C

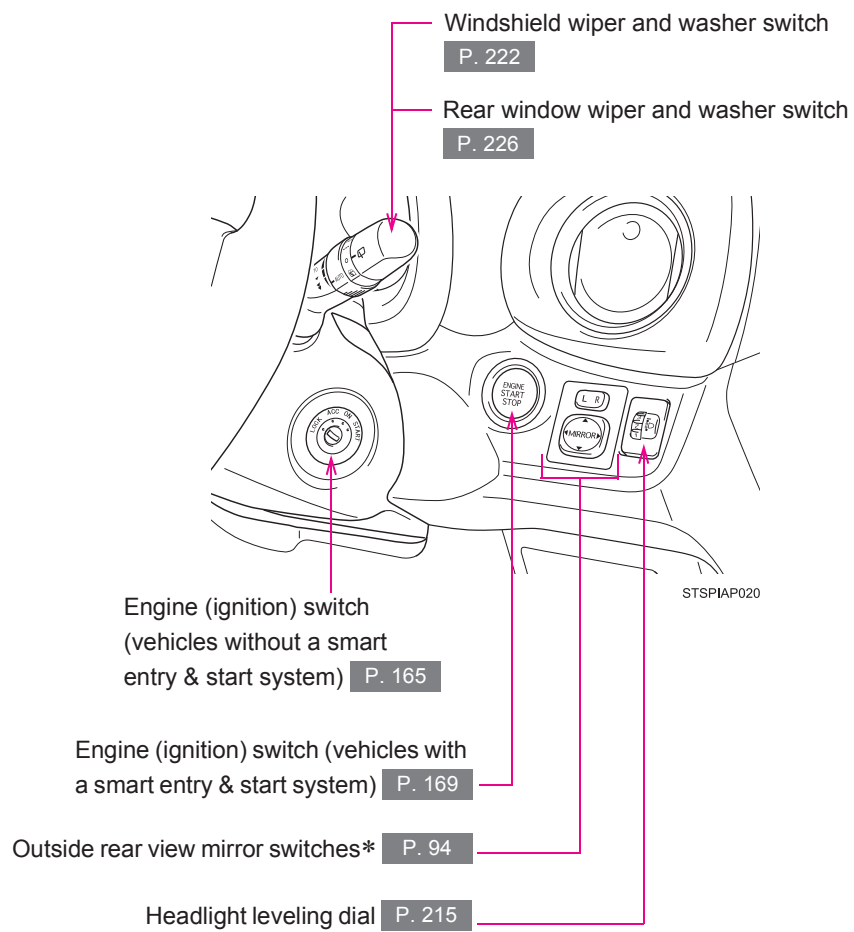

D

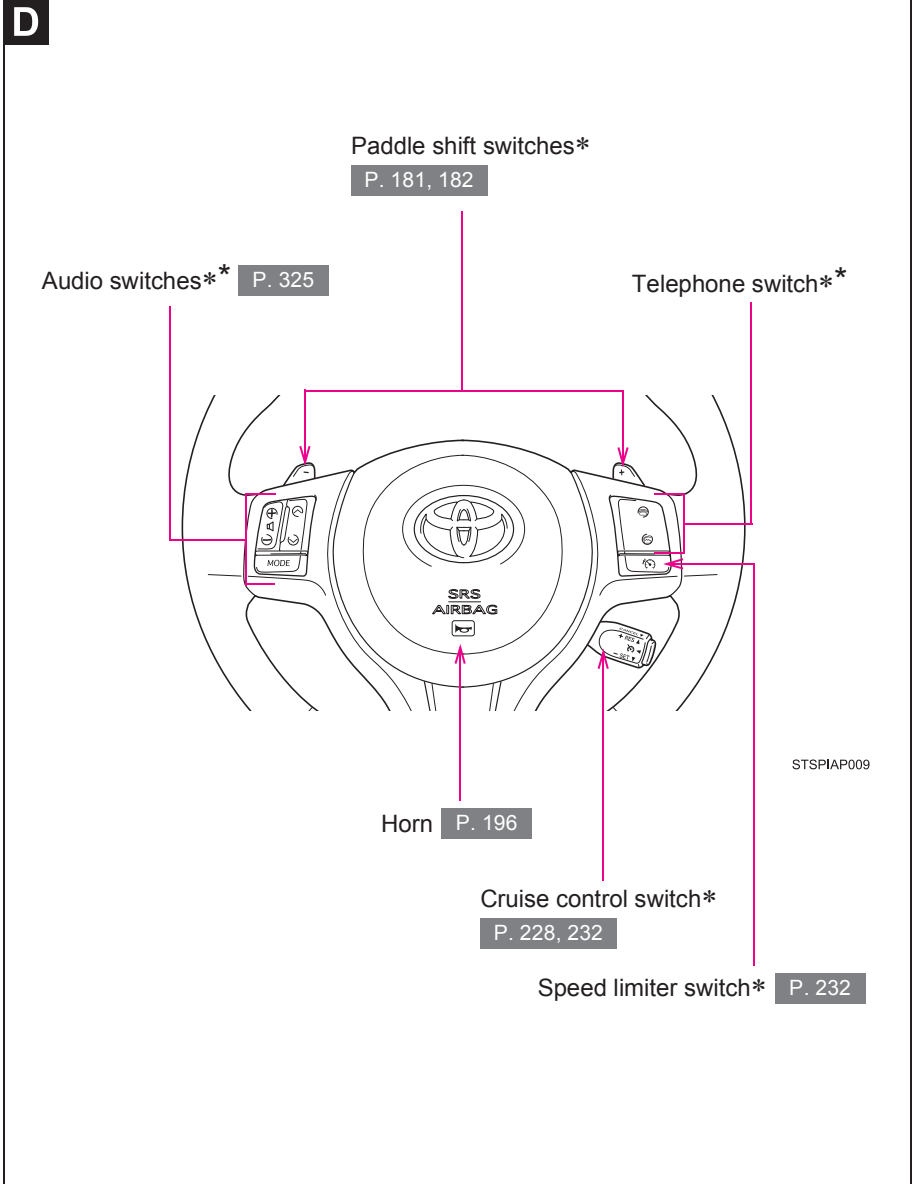

*: If equipped
*: Refer to ""touch screen" Owner's Manual".

For your information

Main Owner's Manual

Please note that this manual applies to all models and all equipment, including options. Therefore, you may find some explanations for equipment not installed on your vehicle.

All specifications provided in this manual are current at the time of printing. However, because of the Toyota policy of continual product improvement, we reserve the right to make changes at any time without notice.

Depending on specifications, the vehicle shown in the illustrations may differ from your vehicle in terms of equipment.

Accessories, spare parts and modification of your Toyota

Both genuine Toyota and a wide variety of other spare parts and accessories for Toyota vehicles are currently available on the market. Should it be determined that any of the genuine Toyota parts or accessories supplied with the vehicle need to be replaced, Toyota recommends that genuine Toyota parts or accessories, be used to replace them. Other parts or accessories of matching quality can also be used. Toyota cannot accept any liability or guarantee spare parts and accessories which are not genuine Toyota products, nor for replacement or installation involving such parts. In addition, damage or performance problems resulting from the use of non-genuine Toyota spare parts or accessories may not be covered under warranty.

Installation of an RF-transmitter system

The installation of an RF-transmitter system in your vehicle could affect electronic systems such as:

- Multiport fuel injection system/sequential multiport fuel injection system
- Cruise control system (if equipped)
- Anti-lock brake system
- SRS airbag system
- Seat belt pretensioner system

Be sure to check with any authorized Toyota dealer or repairer, or another duly qualified and equipped professional for precautionary measures or special instructions regarding installation of an RF-transmitter system.

Further information regarding frequency bands, power levels, antenna positions and installation provisions for the installation of RF-transmitters, is available on request at any authorized Toyota dealer or repairer, or another duly qualified and equipped professional.

Scrapping of your Toyota

The SRS airbag and seat belt pretensioner devices in your Toyota contain explosive chemicals. If the vehicle is scrapped with the airbags and seat belt pretensioners left as they are, this may cause an accident such as fire. Be sure to have the systems of the SRS airbag and seat belt pretensioner removed and disposed of by a qualified service shop or by any authorized Toyota dealer or repairer, or another duly qualified and equipped professional, before you scrap your vehicle.

Vehicle Control and Operation Data Recording

Your Toyota is equipped with sophisticated computers that record certain information about your vehicle's operation, such as:

- Engine speed
- Accelerator status
- Brake status
- Vehicle speed
- Shift position (except manual transmission)

The data recorded varies according to the grade level and options the vehicle is equipped with. The computers do not record conversations, sound or pictures.

● Data usage

Toyota may use the data recorded in these computers to diagnose malfunctions, conduct research and development, and improve quality.

Toyota will not disclose the recorded data to a third party except:

- With the consent of the vehicle owner or with the consent of the lessee if the vehicle is leased
- In response to an official request by the police, a court of law or a government agency
- For research purposes where the data is not tied to a specific vehicle or vehicle owner

● Event data recorder

This vehicle is equipped with an event data recorder (EDR). The main purpose of an EDR is to record, in certain crash or near crash-like situations, such as an air bag deployment or hitting a road obstacle, data that will assist in understanding how a vehicle's systems performed. The EDR is designed to record data related to vehicle dynamics and safety systems for a short period of time, typically 30 seconds or less.

The EDR in this vehicle is designed to record such data as:

- How various systems in your vehicle were operating;
- How far (if at all) the driver was depressing the accelerator and/or brake pedal; and,
- How fast the vehicle was traveling.

These data can help provide a better understanding of the circumstances in which crashes and injuries occur.

NOTE: EDR data are recorded by your vehicle only if a non-trivial crash situation occurs; no data are recorded by the EDR under normal driving conditions and no personal data (e.g., name, gender, age, and crash location) are recorded. However, other parties, such as law enforcement, could combine the EDR data with the type of personally identifying data routinely acquired during a crash investigation.

To read data recorded by an EDR, special equipment is required, and access to the vehicle or the EDR is needed. In addition to the vehicle manufacturer, other parties, such as law enforcement, that have the special equipment, can read the information if they have access to the vehicle or the EDR.

● Disclosure of the EDR data

Toyota will not disclose the data recorded in an EDR to a third party except when:

- An agreement from the vehicle's owner (or the lessee for a leased vehicle) is obtained
- Officially requested by the police or other authorities
- For use by Toyota in a law suit
- Ordered by a court of law

However, if necessary, Toyota will:

- Use the data for research on vehicle safety performance
- Disclose the data to a third party for research purposes without disclosing information about the specific vehicle or vehicle owner



Your vehicle contains batteries and/or accumulators. Do not discard them into the environment but cooperate with separate collection (Directive 2006/66/EC).

 CAUTION

■ **General precautions while driving**

Driving under the influence: Never drive your vehicle when under the influence of alcohol or drugs that have impaired your ability to operate your vehicle. Alcohol and certain drugs delay reaction time, impair judgment and reduce coordination, which could lead to an accident that could result in death or serious injury.

Defensive driving: Always drive defensively. Anticipate mistakes that other drivers or pedestrians might make and be ready to avoid accidents.

Driver distraction: Always give your full attention to driving. Anything that distracts the driver, such as adjusting controls, talking on a cellular phone or reading can result in a collision with resulting death or serious injury to you, your occupants or others.

■ **General precaution regarding children's safety**

Never leave children unattended in the vehicle, and never allow children to have or use the key.

Children may be able to start the vehicle or shift the vehicle into neutral. There is also a danger that children may injure themselves by playing with the cigarette lighter, the windows, the panoramic roof shade, or other features of the vehicle. In addition, heat build-up or extremely cold temperatures inside the vehicle can be fatal to children.

Symbols used throughout this manual

Cautions & Notices

CAUTION

This is a warning against something which, if ignored, may cause death or serious injury to people. You are informed about what you must or must not do in order to reduce the risk of death or serious injury to yourself and others.

NOTICE

This is a warning against something which, if ignored, may cause damage to the vehicle or its equipment. You are informed about what you must or must not do in order to avoid or reduce the risk of damage to your Toyota and its equipment.

Symbols used in illustrations



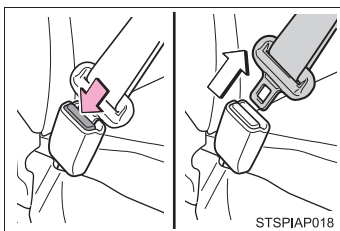

Safety symbol

The symbol of a circle with a slash through it means “Do not”, “Do not do this”, or “Do not let this happen”.



Arrows indicating operations

 Indicates the action (pushing, turning, etc.) used to operate switches and other devices.

 Indicates the outcome of an operation (e.g. a lid opens).

Before driving

1

1-1. Key information		1-4. Opening and closing the windows	
Keys.....	40	Power windows.....	97
1-2. Opening, closing and locking the doors		1-5. Refueling	
Smart entry & start system	44	Opening the fuel tank cap.....	100
Wireless remote control	61	1-6. Theft deterrent system	
Side doors	67	Engine immobilizer system	104
Back door	71	Double locking system.....	107
1-3. Adjustable components (seats, mirrors, steering wheel)		1-7. Safety information	
Front seats.....	76	Correct driving posture	109
Rear seats	79	SRS airbags.....	111
Head restraints	82	Airbag manual on-off system	122
Seat belts.....	84	Child restraint systems	125
Steering wheel.....	91	Installing child restraints ...	134
Anti-glare inside rear view mirror	92		
Outside rear view mirrors	94		

1-1. Key information

Keys

The following keys are provided with the vehicle.

Vehicles without a smart entry & start system (type A)

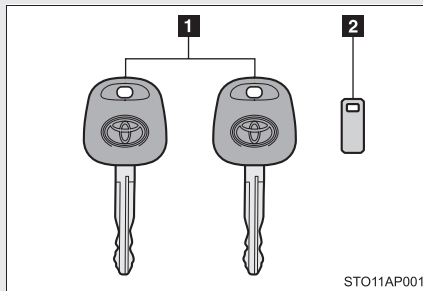

- 1** Keys
- 2** Key number plate

Vehicles without a smart entry & start system (type B)

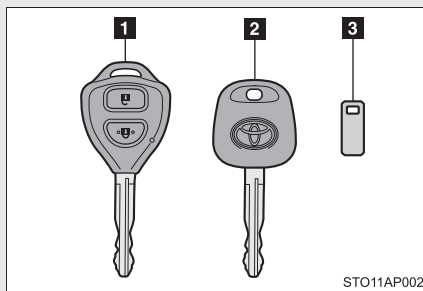

- 1** Key (with a wireless remote control function)
Operating the wireless remote control function (→P. 61)
- 2** Key (without a wireless remote control function)
- 3** Key number plate

Vehicles without a smart entry & start system (type C)

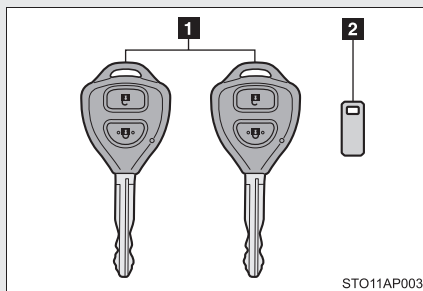

- 1** Keys
Operating the wireless remote control function (→P. 61)
- 2** Key number plate

Vehicles with a smart entry & start system

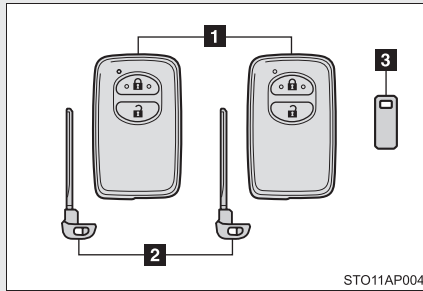

1 Electronic keys

- Operating the smart entry & start system (→P. 44)
- Operating the wireless remote control function (→P. 61)

2 Mechanical keys

3 Key number plate

1

Before driving

Using the mechanical key (vehicles with a smart entry & start system)

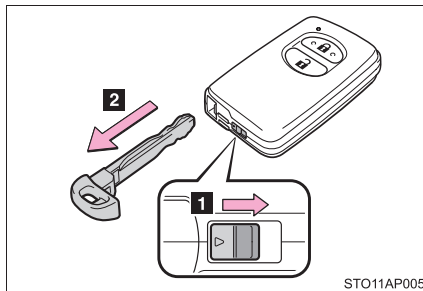

To take out the mechanical key, slide the release knob and take the key out.

After using the mechanical key, store it in the electronic key. Carry the mechanical key together with the electronic key. If the electronic key battery is depleted or the entry function does not operate properly, you will need the mechanical key. (→P. 494)

■ **Key number plate**

Keep the plate in a safe place such as your wallet, not in the vehicle. In the event that a key (vehicles without a smart entry & start system) or mechanical key (vehicles with a smart entry & start system) is lost, a new key can be made by any authorized Toyota dealer or repairer, or another duly qualified and equipped professional using the key number plate. (→P. 493)

■ **When riding in an aircraft**

When bringing a key with wireless remote control function onto an aircraft, make sure you do not press any buttons on the key while inside the aircraft cabin. If you are carrying the key in your bag etc., ensure that the buttons are not likely to be pressed accidentally. Pressing a button may cause the key to emit radio waves that could interfere with the operation of the aircraft.

 NOTICE

■ **To prevent key damage**

Observe the following:

- Do not drop the keys, subject them to strong shocks or bend them.
- Do not expose the keys to high temperatures for a long period of time.
- Do not get the keys wet or wash them in an ultrasonic washer etc.
- Vehicles with a smart entry & start system: Do not attach metallic or magnetic materials to the keys or place the keys close to such materials.
- Do not disassemble the keys.
- Do not attach a sticker or anything else to the surface of the key.
- Vehicles with a smart entry & start system: Do not place the keys near objects that produce magnetic fields, such as TVs, audio systems, glass top ranges, or medical electrical equipment, such as low-frequency therapy equipment.

 NOTICE**■ Carrying the electronic key on your person (vehicles with a smart entry & start system)**

Carry the electronic key 10 cm (3.9 in.) or more away from electric appliances that are turned on. Radio waves emitted from electric appliances within 10 cm (3.9 in.) of the electronic key may interfere with the key, causing the key to not function properly.

■ In case of a smart entry & start system malfunction or other key-related problems (vehicles with a smart entry & start system)

Take your vehicle with all the electronic keys provided with your vehicle to any authorized Toyota dealer or repairer, or another duly qualified and equipped professional.

■ When a vehicle key is lost (vehicles with a smart entry & start system)

If the key remains lost, the risk of vehicle theft increases significantly. Visit any authorized Toyota dealer or repairer, or another duly qualified and equipped professional immediately with all remaining electronic keys that was provided with your vehicle.

1-2. Opening, closing and locking the doors Smart entry & start system*

The following operations can be performed simply by carrying the electronic key on your person, for example in your pocket.
(The driver should always carry the electronic key.)

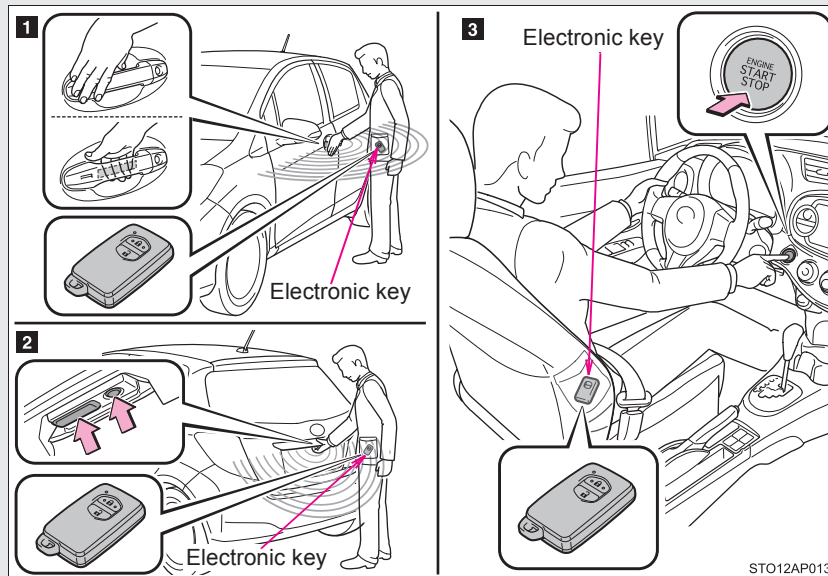

- 1** Unlocks and locks the side doors (→P. 45)
- 2** Unlocks and locks the back door (→P. 46)
- 3** Starts the engine (→P. 169)

*: If equipped

Unlocking and locking the side doors (front door handles only)

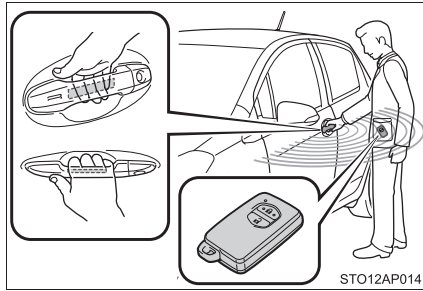

Grip the handle to unlock the doors.

Make sure to touch the sensor on the back of the handle.

The doors cannot be unlocked for 3 seconds after the doors are locked.

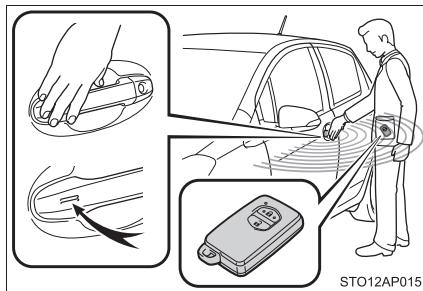

Touch the lock sensor (the indentation on the side of the door handle) to lock the doors.

1

Before driving

1-2. Opening, closing and locking the doors

Unlocking and locking the back door

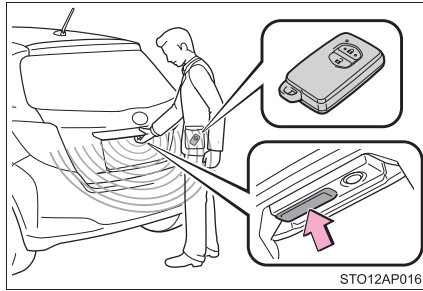

Press the button to unlock the door.

The door cannot be unlocked for 3 seconds after the door is locked.

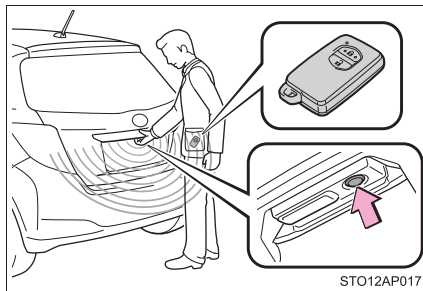

Press the button to lock the door.

Antenna location and effective range

■ Antenna location

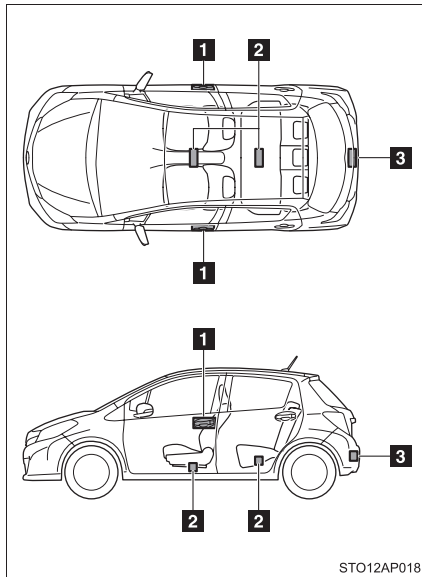

- 1 Antennas outside the cabin
- 2 Antennas inside the cabin
- 3 Antenna outside the luggage compartment

1

Before driving

1-2. Opening, closing and locking the doors

■ Effective range (areas within which the electronic key is detected)

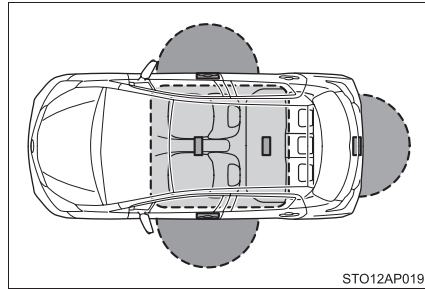

● When locking or unlocking the doors

The system can be operated when the electronic key is within about 0.7 m (2.3 ft.) either of the outside front door handles and back door. (Only the doors detecting the key can be operated.)

● When starting the engine or changing “ENGINE START STOP” switch modes

The system can be operated when the electronic key is inside the vehicle.

■ **Operation signals**

The emergency flashers flash to indicate that the doors have been locked/unlocked. (Locked: once; Unlocked: twice)

■ **When the door cannot be locked by the lock sensor**

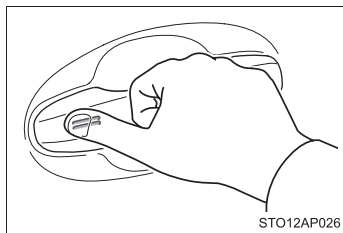

Use your thumb to push the lock sensor.

■ **Alarms and warning indicators**

A combination of exterior and interior alarms as well as warning lights are used to prevent theft of the vehicle and unforeseeable accidents resulting from erroneous operation. Take appropriate measures for the warning light that comes on. (→P. 453)

The following table describes circumstances and correction procedures when only alarms are sounded.

Alarm	Situation	Correction procedure
Exterior alarm sounds once for 5 seconds	An attempt was made to lock the doors using the smart entry & start system while the electronic key was still inside the vehicle.	Retrieve the electronic key from the vehicle and lock the doors again.
	An attempt was made to lock the vehicle while a door was open.	Close all of the doors and lock the doors again.

1-2. Opening, closing and locking the doors

Alarm	Situation	Correction procedure
Interior alarm pings once and exterior alarm sounds once for 5 seconds	An attempt was made to lock either front door by opening a door and putting the inside lock button into the lock position, then closing the door by pulling on the outside door handle with the electronic key still inside the vehicle.	Retrieve the electronic key from the vehicle and lock the doors again.
Interior alarm pings once and exterior alarm sounds once for 5 seconds (on some models)	An attempt was made to lock the doors other than using the smart entry & start system while the electronic key was still inside the vehicle.	Retrieve the electronic key from the vehicle and lock the doors again.
Interior alarm sounds continuously	The "ENGINE START STOP" switch was turned to ACCESSORY mode while the driver's door was open (or the driver's door was opened while the "ENGINE START STOP" switch was in ACCESSORY mode).	Turn the "ENGINE START STOP" switch off and close the driver's door.
Interior alarm sounds continuously*	The driver's door was opened while any shift position other than P was selected without turning off the "ENGINE START STOP" switch.	Shift the shift lever to P.

*: Vehicles with a Multidrive only

■ **Security feature**

If a door is not opened within approximately 30 seconds after the vehicle is unlocked, the security feature automatically locks the vehicle again. (However, depending on the location of the electronic key, the key may be detected as being in the vehicle. In this case, vehicle may be unlocked.)

■ **Battery-saving function**

The battery-saving function will be activated in order to prevent the electronic key battery and the vehicle battery from being discharged while the vehicle is not in operation for a long time.

- In the following situations, the smart entry & start system may take some time to unlock the doors.
 - The electronic key has been left in an area of approximately 2 m (6 ft.) of the outside of the vehicle for 10 minutes or longer.
 - The smart entry & start system has not been used for 5 days or longer.
- If the smart entry & start system has not been used for 14 days or longer, the doors cannot be unlocked at any doors except the driver's door. In this case, take hold of the driver's door handle, or use the wireless remote control or the mechanical key, to unlock the doors.

■ **Conditions affecting operation**

The smart entry & start system uses weak radio waves. In the following situations, the communication between the electronic key and the vehicle may be affected, preventing the smart entry & start system, wireless remote control and engine immobilizer system from operating properly.

(Way of coping →P. 494)

- When the electronic key battery is depleted
- Near a TV tower, electric power plant, gas station, radio station, large display, airport or other facility that generates strong radio waves or electrical noise
- When the electronic key is in contact with, or is covered by the following metallic objects
 - Cards to which aluminum foil is attached
 - Cigarette boxes that have aluminum foil inside
 - Metallic wallets or bags
 - Coins
 - Hand warmers made of metal
 - Media such as CDs and DVDs
- When other wireless key (that emit radio waves) is being used nearby
- When carrying the electronic key together with the following devices that emit radio waves
 - A portable radio, cellular phone, cordless phone or other wireless communication device
 - Another vehicle's electronic key or a wireless key that emits radio waves
 - Personal computers or personal digital assistants (PDAs)
 - Digital audio players
 - Portable game systems
- If window tint with a metallic content or metallic objects are attached to the rear window
- When the electronic key is placed near a battery charger or electronic devices

■ **Notes for the entry function**

- Even when the electronic key is within the effective range (detection areas), the system may not operate properly in the following cases:
 - The electronic key is too close to the window or outside door handle, near the ground, or in a high place when the doors are locked or unlocked.
 - The electronic key is on the instrument panel, luggage cover (if equipped) or floor, or in the door pockets, glove box, accessory box of the instrument panel, or in/near the front cup holder when the engine is started or “ENGINE START STOP” switch modes are changed.
- Do not leave the electronic key on top of the instrument panel or near the door pockets when exiting the vehicle. Depending on the radio wave reception conditions, it may be detected by the antenna outside the cabin and the door will become lockable from the outside, possibly trapping the electronic key inside the vehicle.
- As long as the electronic key is within the effective range, the doors may be locked or unlocked by anyone.
- Even if the electronic key is not inside the vehicle, it may be possible to start the engine if the electronic key is near the window.
- The doors may unlock if a large amount of water splashes on the door handle, such as in the rain or in a car wash when the electronic key is within the effective range. (The door will automatically be locked after approximately 30 seconds if the doors are not opened and closed.)
- Gripping the door handle when wearing a glove may not unlock the door.
- If the wireless remote control is used to lock the doors when the electronic key is near the vehicle, there is a possibility that the door may not be unlocked by the entry function. (Use the wireless remote control to unlock the doors.)
- A sudden approach to the effective range or door handle may prevent the doors from being unlocked. In this case, return the door handle to the original position and check that the doors unlock before pulling the door handle again.

■ **Notes for locking the doors**

- Touching the door lock sensor while wearing gloves may delay or prevent lock operation. Remove the gloves and touch the lock sensor again.
- If the door handle becomes wet while the electronic key is within the effective range, the door may lock and unlock repeatedly. Place the key in a position 2 m (6 ft.) or more separate from the vehicle while the vehicle is being washed. (Take care to ensure that the key is not stolen.)
- If the electronic key is inside the vehicle and a door handle becomes wet during a car wash, a buzzer will sound outside the vehicle. To turn off the alarm, lock all the doors.
- The lock sensor may not work properly if it comes into contact with ice, snow, mud, etc. Clean the lock sensor and attempt to operate it again.

■ **Notes for the unlocking function**

- A sudden approach to the effective range or door handle may prevent the doors from being unlocked. In this case, return the door handle to the original position and check that the doors unlock before pulling the door handle again.
- Gripping the door handle when wearing a glove may not unlock the door. Remove the gloves and touch the sensor on the back of the handle again.
- If the door handle becomes wet while the electronic key is within the effective range, the door may lock and unlock repeatedly. Place the key in a position 2 m (6 ft.) or more separate from the vehicle while the vehicle is being washed. (Take care to ensure that the key is not stolen.)
- If there is another electronic key in the detection area, it may take slightly longer to unlock the doors after the door handle is gripped.

■ **When the vehicle is not driven for extended periods**

- To prevent theft of the vehicle, do not leave the electronic key within 2 m (6 ft.) of the vehicle.
- The smart entry & start system can be deactivated in advance. (→P. 542)

■ **To operate the system properly**

Make sure to carry the electronic key when operating the system. Do not get the electronic key too close to the vehicle when operating the system from the outside of the vehicle.

Depending on the position and holding condition of the electronic key, the key may not be detected correctly and the system may not operate properly. (The alarm may go off accidentally, or the door lock prevention function may not operate.)

■ **If the smart entry & start system does not operate properly**

- Locking and unlocking the doors: Use the mechanical key. (→P. 494)
- Starting the engine: →P. 494

■ **Electronic key battery depletion**

- The standard battery life is 1 to 2 years.
- If the battery becomes low, an alarm will sound in the cabin when the engine stops. (→P. 453)
- As the electronic key always receives radio waves, the battery will become depleted even if the electronic key is not used. The following symptoms indicate that the electronic key battery may be depleted. Replace the battery when necessary. (→P. 401)
 - The smart entry & start system or the wireless remote control does not operate.
 - The detection area becomes smaller.
 - The LED indicator on the key surface does not turn on.
- To avoid serious deterioration, do not leave the electronic key within 1 m (3 ft.) of the following electrical appliances that produce a magnetic field:
 - TVs
 - Personal computers
 - Cellular phones, cordless phones and battery chargers
 - Recharging cellular phones or cordless phones
 - Glass top ranges
 - Table lamps

1-2. Opening, closing and locking the doors

■ When the electronic key battery is fully depleted

→P. 401

■ If the smart entry & start system has been deactivated in a customized setting

● Locking and unlocking the doors: Use the wireless remote control or mechanical key. (→P. 61, 494)

● Starting the engine and changing “ENGINE START STOP” switch modes: →P. 494

● Stopping the engine: →P. 172

■ Customization that can be configured at any authorized Toyota dealer or repairer, or another duly qualified and equipped professional

Settings (e. g. smart entry & start system) can be changed.

(Customizable features: →P. 542)

■ Certification for the smart entry & start system



R&TTE Declaration of Conformity

We,

Manufacturer's name: Valeo Security Systems
Manufacturer's address: 76, rue Auguste Perret
F-96046 Créteil - France

hereby declare under our sole responsibility that the products:

Product name:	Model No.:
Smart Key	A02TAA
Smart Tuner	A02RAA
Engine Switch	A02IAA
Power Smart ECU	A02SAA

to which this declaration relates, comply with the essential protection requirements of R&TTE Directive (1999/5/ EC)
The products are compliant with the following standards and/or normative documents:

- Radio matters: EN 300 220-1 V2.3.1 (2010-02), EN 300 220-2 V2.3.1 (2010-02)
EN 300 330-1 V 1.7.1 (2010-02), EN 300 330-2 V1.5.1 (2010-02)
- EMC: EN 301 489-1 V1.8.1 (2008-04), EN 301 489-3 V1.4.1 (2002-08)
- Electrical Safety: EN 60950-1 (2006) + A11(2009)

CE marking:

CE 0682

Signature:

Jérôme Hugot
Approval Engineer

Date: March 22, 2011

1

Before driving

1-2. Opening, closing and locking the doors

Valeo Security Systems tímto prohlašuje, že tento A02TAA, A02RAA, A02SAA & A02IAA je ve shodě se základními požadavky a dalšími příslušnými ustanoveními směrnice 1999/5/ES.
Undertegnede Valeo Security Systems erklærer herved, at følgende udstyr A02TAA, A02RAA, A02SAA & A02IAA overholder de væsentlige krav og øvrige relevante krav i direktiv 1999/5/EF.
Hiermit erklärt Valeo Security Systems, dass sich das Gerät A02TAA, A02RAA, A02SAA & A02IAA in Übereinstimmung mit den grundlegenden Anforderungen und den übrigen einschlägigen Bestimmungen der Richtlinie 1999/5/EG befindet.
Käesolevaga kinnitab Valeo Security Systems seadme A02TAA, A02RAA, A02SAA & A02IAA vastavust direktiivi 1999/5/EÜ põhinõuetele ja nimetatud direktiivist tulenevatele teistele asjakohastele sätetele.
Hereby, Valeo Security Systems declares that this A02TAA, A02RAA, A02SAA & A02IAA is in compliance with the essential requirements and other relevant provisions of Directive 1999/5/EC.
Por medio de la presente Valeo Security Systems declara que A02TAA, A02RAA, A02SAA & A02IAA cumple con los requisitos esenciales y cualesquiera otras disposiciones aplicables o exigibles de la Directiva 1999/5/CE.
ΜΕ ΤΗΝ ΠΑΡΟΥΣΑ Valeo Security Systems ΔΗΛΩΝΕΙ ΟΤΙ Α02ΤΑΑ, Α02ΡΑΑ, Α02ΣΑΑ & Α02ΙΑΑ ΣΥΜΜΟΡΦΩΝΕΤΑΙ ΠΡΟΣ ΤΙΣ ΟΥΣΙΩΔΕΙΣ ΑΠΑΙΤΗΣΕΙΣ ΚΑΙ ΤΙΣ ΛΟΙΠΕΣ ΣΧΕΤΙΚΕΣ ΔΙΑΤΑΞΕΙΣ ΤΗΣ ΟΔΗΓΙΑΣ
Par la présente Valeo Security Systems déclare que les appareils A02TAA, A02RAA, A02SAA & A02IAA sont conformes aux exigences essentielles et aux autres dispositions pertinentes de la directive 1999/5/CE.
Con la presente Valeo Security Systems dichiara che questo A02TAA, A02RAA, A02SAA & A02IAA è conforme ai requisiti essenziali ed alle altre disposizioni pertinenti stabilite dalla direttiva 1999/5/CE.
Ar šo Valeo Security Systems deklarē, ka A02TAA, A02RAA, A02SAA & A02IAA atbilst Direktīvas 1999/5/EK būtiskajām prasībām un citiem ar to saistītajiem noteikumiem.
Šiuo Valeo Security Systems deklaruoja, kad šis A02TAA, A02RAA, A02SAA & A02IAA atitinka esminius reikalavimus ir kitas 1999/5/EB Direktyvos nuostatas.
Hierbij verklaart Valeo Security Systems dat het toestel A02TAA, A02RAA, A02SAA & A02IAA in overeenstemming is met de essentiële eisen en de andere relevante bepalingen van richtlijn 1999/5/EG.

1-2. Opening, closing and locking the doors

Hawnhekk, Valeo Security Systems , jiddikjara li dan A02TAA, A02RAA, A02SAA & A02IAA jikkonforma mal-htigijiet essenzjali u ma provvedimenti oħrajn relevanti li hemm fid-Dirrettiva 1999/5/EC.
Alulírott, Valeo Security Systems nyilatkozom, hogy a A02TAA, A02RAA, A02SAA & A02IAA megfelel a vonatkozó alapvető követelményeknek és az 1999/5/EC irányelv egyéb előírásainak.
Niniejszym Valeo Security Systems oświadcza, że A02TAA, A02RAA, A02SAA & A02IAA jest zgodny z zasadniczymi wymogami oraz pozostałymi stosownymi postanowieniami Dyrektywy 1999/5/EC.
Valeo Security Systems declara que este A02TAA, A02RAA, A02SAA & A02IAA está conforme com os requisitos essenciais e outras disposições da Directiva 1999/5/CE.
Valeo Security Systems izjavlja, da je ta A02TAA, A02RAA, A02SAA & A02IAA v skladu z bistvenimi zahtevami in ostalimi relevantnimi določili direktive 1999/5/ES.
Valeo Security Systems tímto vyhlasuje, že A02TAA, A02RAA, A02SAA & A02IAA splňa základné požiadavky a všetky príslušné ustanovenia Smernice 1999/5/ES.
Valeo Security Systems vakuuttaa täten että A02TAA, A02RAA, A02SAA & A02IAA tyyppinen laite on direktiivin 1999/5/EY oleellisten vaatimusten ja sitä koskevien direktiivin muiden ehtojen mukainen.
Härmed intygar Valeo Security Systems att denna A02TAA, A02RAA, A02SAA & A02IAA står i överensstämmelse med de väsentliga egenskapskrav och övriga relevanta bestämmelser som framgår av direktiv 1999/5/EG.
Hér með lýsir Valeo Security Systems yfir því að A02TAA, A02RAA, A02SAA & A02IAA er í samræmi við grunnkröfur og aðrar kröfur, sem gerðar eru í tilskipun 1999/5/EC.
Ovim ,Valeo Security Sytems, izjavluje da ovaj A02TAA, A02RAA, A02SAA & A02IAA je usklađen sa bitnim zahtjevima i drugim relevantnim odredbama Direktive 1999/5/EC.
Valeo Security Systems erklærer herved at utstyret A02TAA, A02RAA, A02SAA & A02IAA er i samsvar med de grunnleggende krav og øvrige relevante krav i direktiv 1999/5/EF.

1

Before driving

1-2. Opening, closing and locking the doors

■ Certification for the smart entry & start system electronic key (vehicles sold in South Africa)



CAUTION

■ Caution regarding interference with electronic devices

- People with implanted pacemakers or cardiac defibrillators should maintain a reasonable distance between themselves and the smart entry & start system antennas. (→P. 47)

The radio waves may affect the operation of such devices. If necessary, the entry function can be disabled. Ask any authorized Toyota dealer or repairer, or another duly qualified and equipped professional for details, such as the frequency of radio waves and timing of emitting the radio waves. Then, consult your doctor to see if you should disable the entry function.

- Users of any electrical medical device other than implanted pacemakers and implanted cardiac defibrillators should consult the manufacturer of the device for information about its operation under the influence of radio waves.

Radio waves could have unexpected effects on the operation of such medical devices.

Ask any authorized Toyota dealer or repairer, or another duly qualified and equipped professional for details on disabling the entry function.

1-2. Opening, closing and locking the doors Wireless remote control*

The wireless remote control can be used to lock and unlock the vehicle.

Vehicles without a smart entry & start system

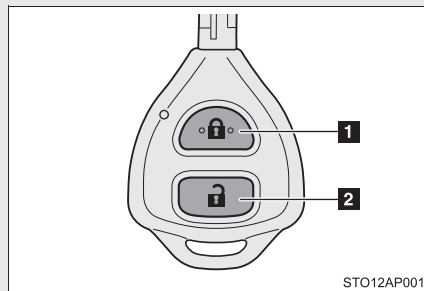

- 1 Locks all the doors
- 2 Unlocks all the doors

Vehicles with a smart entry & start system

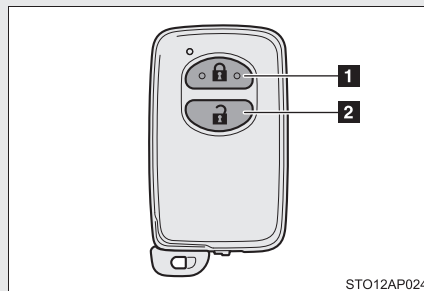

- 1 Locks all the doors
- 2 Unlocks all the doors

1

Before driving

■ Operation signals

The emergency flashers flash to indicate that the doors have been locked/unlocked. (Locked: once; Unlocked: twice)

■ Door lock buzzer (vehicles with a smart entry & start system)

If an attempt to lock the doors is made when a door is not fully closed, a buzzer sounds continuously. Fully close the door to stop the buzzer, and lock the vehicle once more.

*: If equipped

1-2. Opening, closing and locking the doors

■ Security feature

If a door is not opened within approximately 30 seconds after the vehicle is unlocked, the security feature automatically locks the vehicle again.

■ Conditions affecting operation

Vehicles without a smart entry & start system

The wireless remote control function may not operate normally in the following situations:

- When the wireless key battery is depleted
- Near a TV tower, electric power plant, gas station, radio station, large display, airport or other facility that generates strong radio waves or electrical noise
- When carrying a portable radio, cellular phone or other wireless communication devices
- When the wireless key is in contact with, or is covered by a metallic object
- When other wireless key (that emit radio waves) is being used nearby
- If window tint with a metallic content or metallic objects are attached to the rear window

Vehicles with a smart entry & start system

→P. 52

■ If the wireless remote control does not operate properly (vehicles with a smart entry & start system)

Locking and unlocking the doors: Use the mechanical key. (→P. 494)

■ Key battery depletion

Vehicles without a smart entry & start system

If the wireless remote control function does not operate, the battery may be depleted. Replace the battery when necessary. (→P. 401)

Vehicles with a smart entry & start system

→P. 55

■ When the key battery is fully depleted

→P. 401

■ **Confirmation of the registered key number (vehicles with a smart entry and start system)**

The number of keys already registered to the vehicle can be confirmed. Ask any authorized Toyota dealer or repairer, or another duly qualified and equipped professional for details.

■ **Customization that can be configured at any authorized Toyota dealer or repairer, or another duly qualified and equipped professional**

Settings (e.g. wireless remote control system) can be changed.
(Customizable features →P. 542)

1

Before driving

1-2. Opening, closing and locking the doors

■ Certification for wireless remote control (vehicles without a smart entry & start system)



R&TTE Declaration of Conformity

We,

Manufacturer's name: Valeo Security Systems
Manufacturer's address: 76, rue Auguste Perret
F-96046 Créteil - France

hereby declare under our sole responsibility that the products:

Product name:	Model No.:
RF Key (Transmitter)	0603A1-A
RF Receiver	A03RAA

to which this declaration relates, comply with the essential protection requirements of R&TTE Directive (1999/5/ EC).
The products are compliant with the following standards and/or normative documents:

- Radio matters: EN ETSI 300 220-1 V2.3.1 (2010-02), EN ETSI 300 220-2 V2.3.1 (2010-02)
- EMC: EN ETSI 301 489-1 V1.8.1 (2008-04), ETSI EN 301 489-3 V1.4.1 (2002-08)
- Electrical Safety: EN 60950-1: 2006/A11:2009/A1:2010

CE marking:



Signature:

Jérôme Hugot
Approval Engineer
Date: 31-Jan-11

1-2. Opening, closing and locking the doors

Valeo Security Systems tímto prohlašuje, že tento 0603A1-A & A03RAA je ve shodě se základními požadavky a dalšími příslušnými ustanoveními směrnice 1999/5/ES.
Undertegnede Valeo Security Systems erklærer herved, at følgende udstyr 0603A1-A & A03RAA overholder de væsentlige krav og øvrige relevante krav i direktiv 1999/5/EF.
Hiermit erkläre Valeo Security Systems, dass sich das Gerät 0603A1-A & A03RAA in Übereinstimmung mit den grundlegenden Anforderungen und den übrigen einschlägigen Bestimmungen der Richtlinie 1999/5/EG befindet.
Käesolevaga kinnitab Valeo Security Systems seadme 0603A1-A & A03RAA vastavust direktiivi 1999/5/EÜ põhinõuetele ja nimetatud direktiivist tulenevatele teistele asjakohastele sätetele.
Hereby, Valeo Security Systems declares that this 0603A1-A & A03RAA is in compliance with the essential requirements and other relevant provisions of Directive 1999/5/EC.
Por medio de la presente Valeo Security Systems declara que 0603A1-A & A03RAA cumple con los requisitos esenciales y cualesquiera otras disposiciones aplicables o exigibles de la Directiva 1999/5/CE.
ΜΕ ΤΗΝ ΠΑΡΟΥΣΑ Valeo Security Systems ΔΗΛΩΝΕΙ ΟΤΙ 0603A1-A & A03RAA ΣΥΜΜΟΡΦΩΝΕΤΑΙ ΠΡΟΣ ΤΙΣ ΟΥΣΙΩΔΕΙΣ ΑΠΑΙΤΗΣΕΙΣ ΚΑΙ ΤΙΣ ΛΟΙΠΕΣ ΣΧΕΤΙΚΕΣ ΔΙΑΤΑΞΕΙΣ ΤΗΣ ΟΔΗΓΙΑΣ
Par la présente Valeo Security Systems déclare que les appareils 0603A1-A & A03RAA sont conformes aux exigences essentielles et aux autres dispositions pertinentes de la directive 1999/5/CE.
Con la presente Valeo Security Systems dichiara che questo 0603A1-A & A03RAA è conforme ai requisiti essenziali ed alle altre disposizioni pertinenti stabilite dalla direttiva 1999/5/CE.
Ar šo Valeo Security Systems deklarē, ka 0603A1-A & A03RAA atbilst Direktīvas 1999/5/EK būtiskajām prasībām un citiem ar to saistītajiem noteikumiem.
Šiuo Valeo Security Systems deklaruoja, kad šis 0603A1-A & A03RAA atitinka esminius reikalavimus ir kitas 1999/5/EB Direktyvos nuostatas.
Hierbij verklaart Valeo Security Systems dat het toestel 0603A1-A & A03RAA in overeenstemming is met de essentiële eisen en de andere relevante bepalingen van richtlijn 1999/5/EG.

1

Before driving

1-2. Opening, closing and locking the doors

Hawnhekk, Valeo Security Systems , jiddikjara li dan 0603A1-A & A03RAA jikkonforma mal-htigijiet essenzjali u ma provvedimenti oħrajn relevanti li hemm fid-Dirrettiva 1999/5/EC.
Alulírott, Valeo Security Systems nyilatkozom, hogy a 0603A1-A & A03RAA megfelel a vonatkozó alapvető követelményeknek és az 1999/5/EC irányelv egyéb előírásainak.
Niniejszym Valeo Security Systems oświadcza, że 0603A1-A & A03RAA jest zgodny z zasadniczymi wymogami oraz pozostałymi stosownymi postanowieniami Dyrektywy 1999/5/EC.
Valeo Security Systems declara que este 0603A1-A & A03RAA está conforme com os requisitos essenciais e outras disposições da Directiva 1999/5/CE.
Valeo Security Systems izjavlja, da je ta 0603A1-A & A03RAA v skladu z bistvenimi zahtevami in ostalimi relevantnimi določili direktive 1999/5/ES.
Valeo Security Systems týmto vyhlasuje, že 0603A1-A & A03RAAA spĺňa základné požiadavky a všetky príslušné ustanovenia Smernice 1999/5/ES.
Valeo Security Systems vakuuttaa täten että 0603A1-A & A03RAAA tyyppinen laite on direktiivin 1999/5/EY oleellisten vaatimusten ja sitä koskevien direktiivin muiden ehtojen mukainen.
Härmed intygar Valeo Security Systems att denna 0603A1-A & A03RAA står i överensstämmelse med de väsentliga egenskapskrav och övriga relevanta bestämmelser som framgår av direktiv 1999/5/EG.
Hér með lýsir Valeo Security Systems yfir því að 0603A1-A & A03RAA er í samræmi við grunnkröfur og aðrar kröfur, sem gerðar eru í tilskipun 1999/5/EC.
Ovim ,Valeo Security Sytems, izjavluje da ovaj 0603A1-A & A03RAA je usklađen sa bitnim zahtjevima i drugim relevantnim odredbama Direktive 1999/5/EC.
Valeo Security Systems erklærer herved at utstyret 0603A1-A & A03RAA er i samsvar med de grunnleggende krav og øvrige relevante krav i direktiv 1999/5/EF.



1-2. Opening, closing and locking the doors

Side doors

The vehicle can be locked and unlocked using the entry function, wireless remote control, key or door lock switch.

■ **Entry function (vehicles with a smart entry & start system)**

→P. 45

■ **Wireless remote control (if equipped)**

→P. 61

■ **Keys (vehicles without a smart entry & start system)**

Turning the key operates the doors as follows:

Driver's door

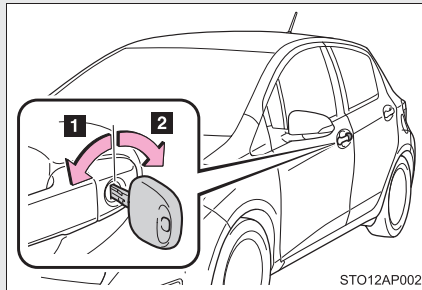

1 Locks all the doors

2 Unlocks all the doors

Front passenger's door (vehicles with a key cylinder)

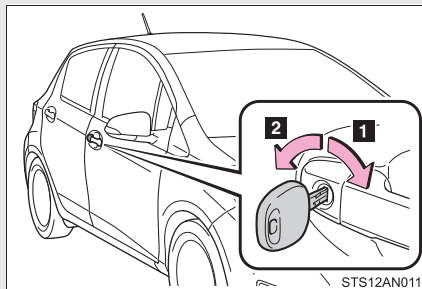

1 Locks the door

2 Unlocks the door

■ **Keys (vehicles with a smart entry & start system)**

The doors can also be locked and unlocked with the mechanical key. (→P. 494)

1-2. Opening, closing and locking the doors

■ Door lock switch

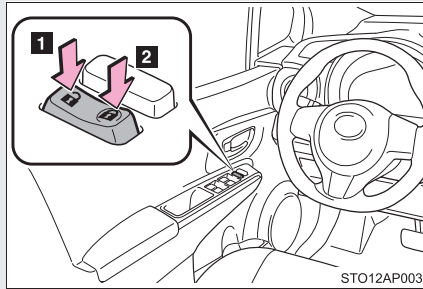

- 1 Unlocks all the doors
- 2 Locks all the doors

■ Inside door lock buttons

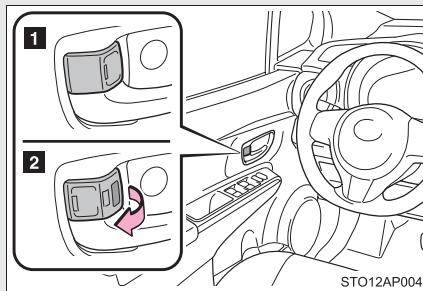

- 1 Locks the door
- 2 Unlocks the door

The front doors can be opened by pulling the inside handle even if the lock button is in the lock position.

Locking the front doors from the outside without a key

- STEP 1** Move the inside door lock button to the lock position.
- STEP 2** Close the door while pulling the door handle.

Vehicles without a smart entry & start system

The door cannot be locked if the key is in the engine switch.

Vehicles with a smart entry & start system

The door cannot be locked if the “ENGINE START STOP” switch is in ACCESSORY or IGNITION ON mode, or the electronic key is left inside the vehicle.

The key may not be detected correctly and the door may be locked.

Rear door child-protector lock (5-door models only)



The door cannot be opened from inside the vehicle when the lock is set.

- 1 Unlock
- 2 Lock

These locks can be set to prevent children from opening the rear doors. Push down on each rear door switch to lock both rear doors.

1

Before driving

■ **Impact detection door lock release system**

In the event that the vehicle is subject to a strong impact, all the doors are unlocked. Depending on the force of the impact or the type of accident, however, the system may not operate.

■ **Using the mechanical key (vehicles with a smart entry & start system)**

The doors can also be locked and unlocked with the mechanical key. (→P. 494)

■ **If a wrong key is used (if equipped)**

The key cylinder rotates freely to isolate inside mechanism.

■ **If the smart entry & start system has been deactivated in a customized setting (vehicles with a smart entry & start system)**

Use the wireless remote control or mechanical key. (→P. 61, 494)

 CAUTION

■ **To prevent an accident**

Observe the following precautions while driving the vehicle.
Failing to do so may result in a door opening and an occupant falling out, resulting in death or serious injury.

- Always use a seat belt.
- Ensure that all the doors are properly closed.
- Do not pull the inside handle of the doors while driving.
The doors may be opened and the passengers are thrown out of the vehicle and it may result in serious injury or death.
Be especially careful for the front doors, as the doors may be opened even if the inside lock buttons are in locked position.
- Set the rear door child-protector locks when children are seated in the rear seats.

1-2. Opening, closing and locking the doors

Back door

The back door can be locked/unlocked and opened by the following procedures.

■ Locking and unlocking the back door

Keys (from the back door: vehicles with a back door key cylinder)

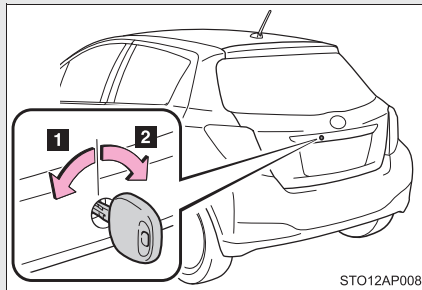

- 1 Unlocks all the doors
- 2 Locks all the doors

Keys (from the driver's door)

→P. 67

Wireless remote control (if equipped)

→P. 61

Door lock switch

→P. 68

Entry function (vehicles with a smart entry & start system)

→P. 45

■ Opening the back door from outside the vehicle

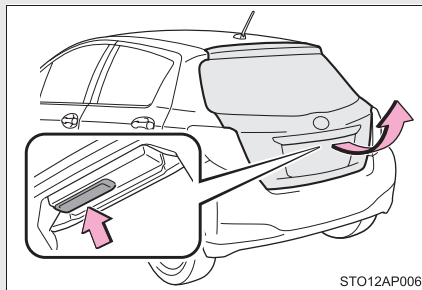

Raise the back door while pushing up the back door opener switch.

The back door cannot be closed immediately after the back door opener switch is pushed.

1

Before driving

1-2. Opening, closing and locking the doors

■ When closing the back door

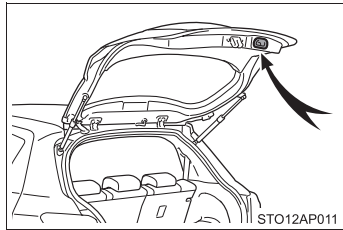

Lower the back door using the back door handle, and make sure to push the back door down from the outside to close it.

■ Luggage compartment light

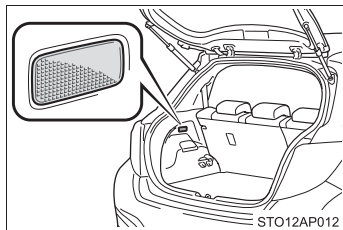

The luggage compartment light turns on when the back door is opened.

■ If the smart entry & start system has been deactivated in a customized setting (vehicles with a smart entry & start system)

Use the wireless remote control or mechanical key. (→P. 61, 494)

 CAUTION

■ **Caution while driving**

- Keep the back door closed while driving.
If the back door is left open, it may hit near-by objects while driving or luggage may be unexpectedly thrown out, causing an accident.
In addition, exhaust gases may enter the vehicle, causing death or a serious health hazard. Make sure to close the back door before driving.
- Before driving the vehicle, make sure that the back door is fully closed. If the back door is not fully closed, it may open unexpectedly while driving, causing an accident.
- Never let anyone sit in the luggage compartment. In the event of sudden braking or a collision, they are susceptible to death or serious injury.

■ **When children are in the vehicle**

Observe the following precautions.

Failure to do so may result in death or serious injury.

- Do not leave children alone in the luggage compartment.
If a child is accidentally locked in the luggage compartment, they could have heat exhaustion.
- Do not allow a child to open or close the back door.
Doing so may cause the back door to move unexpectedly, or cause the child's hands, head, or neck to be caught by the closing back door.

⚠ CAUTION

■ Operating the back door

Observe the following precautions.

Failure to do so may cause parts of the body to be caught, resulting in death or serious injury.

- Remove any heavy loads, such as snow and ice, from the back door before opening it. Failure to do so may cause the back door to fall closed again after it is opened.
- When opening or closing the back door, thoroughly check to make sure the surrounding area is safe.
- If anyone is in the vicinity, make sure they are safe and let them know that the back door is about to open or close.
- Use caution when opening or closing the back door in windy weather as it may move abruptly in strong wind.

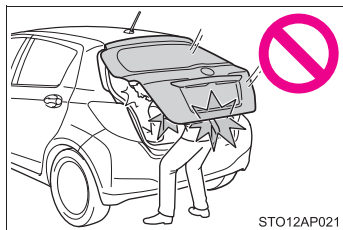

- The back door may fall if it is not opened fully. It is more difficult to open or close the back door on an incline than on a level surface, so beware of the back door unexpectedly opening or closing by itself. Make sure that the back door is fully open and secure before using the luggage compartment.

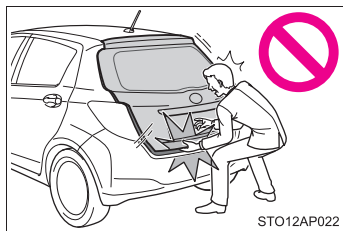

- When closing the back door, take extra care to prevent your fingers etc. from being caught.
- When closing the back door, make sure to press it lightly on its outer surface. If the back door handle is used to fully close the back door, it may result in hands or arms being caught.

⚠ CAUTION

- Do not pull on the back door damper stay to close the back door, and do not hang on the back door damper stay. Doing so may cause hands to be caught or the back door damper stay to break, causing an accident.
- If a bicycle carrier or similar heavy object is attached to the back door, it may fall closed again after being opened, causing someone's hands, head or neck to be caught and injured. When installing an accessory part to the back door, using a genuine Toyota part is recommended.

⚠ NOTICE

■ **Back door damper stays**

The back door is equipped with damper stays that hold the back door in place.

Observe the following precautions.

Failure to do so may cause damage to the back door damper stay, resulting in malfunction.

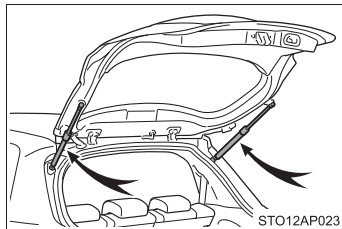

- Do not attach any foreign objects, such as stickers, plastic sheets, or adhesives to the damper stay rod.
- Do not touch the damper stay rod with gloves or other fabric items.
- Do not attach any accessories other than genuine Toyota parts to the back door.
- Do not place your hand on the damper stay or apply lateral forces to it.

1-3. Adjustable components (seats, mirrors, steering wheel) Front seats

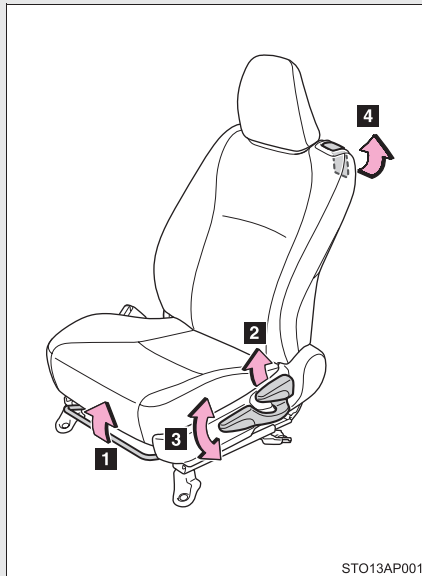

STO13AP001

- 1** Seat position adjustment lever
- 2** Seatback angle adjustment lever
- 3** Vertical height adjustment lever (if equipped)
- 4** Seatback lock release lever (3-door models only)

Moving front seats for rear seat entry (3-door models only)

■ **Getting in the vehicle**

For easy access to the rear seat, use the seatback lock release lever. When the seatback lock release lever is used, the seat's original position is memorized, so the seat may be returned to that original position. However, if the seatback angle adjustment lever is used, the seat will not return to its original position.

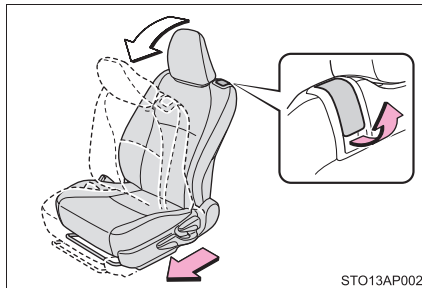

Lift the seatback lock release lever. The seatback will fold forward, and the seat's slide lock will be released. Move the seat all the way forward.

■ **Getting out of the vehicle**

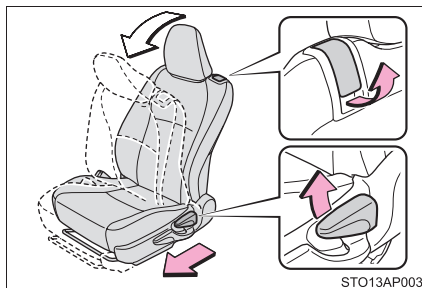

Lift the seatback lock release lever or seatback angle adjustment lever. The seatback will fold forward, and the seat's slide lock will be released. Move the seat all the way forward.

■ **After passengers have entered the vehicle (3-door models only)**

Slide the seat backward and then lift the seatback. The seat will be set and locked to its previous position automatically. If the seat cannot be slid back to the previous position due to the rear passenger or luggage, the seat will be locked in that position, disabling the seat position memory system.

To recall the previous position, lift the seatback lock release lever after removing the luggage, or after having the passenger get out or sit properly so that the seat can be slid back to the previous position. However, if you slide the seat further backwards than previous position using the seat position adjustment lever, the memory of previous position will be overwritten.

 **CAUTION**

■ **Seat adjustment**

- Be careful that the seat does not hit passengers or luggage.
- To reduce the risk of sliding under the lap belt during a collision, do not recline the seat more than necessary.
If the seat is too reclined, the lap belt may slide past the hips and apply restraint forces directly to the abdomen, or your neck may contact the shoulder belt, increasing the risk of death or serious injury in the event of an accident.
Adjustments should not be made while driving as the seat may unexpectedly move and cause the driver to lose control of the vehicle.
- After adjusting the seat, make sure that the seat is locked in position.
- Never allow anyone to touch seatback lock release levers while the vehicle is moving.
- If anyone is in the vicinity, make sure they are clear of the seat back path and let them know that the seat is about to move.

■ **After returning the seatback to the upright position**

Make sure the seatback is securely locked by pushing it forward and rearward. Failure to do so may result in death or serious injury.

1-3. Adjustable components (seats, mirrors, steering wheel) Rear seats*

The seatbacks of the rear seats can be folded down.

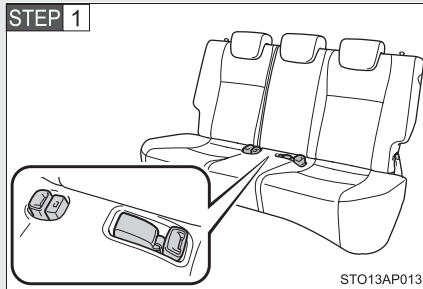

Stow the rear seat belt buckles as shown.

STEP 2 Stow the seat belts.

Center

→P. 85

Outside

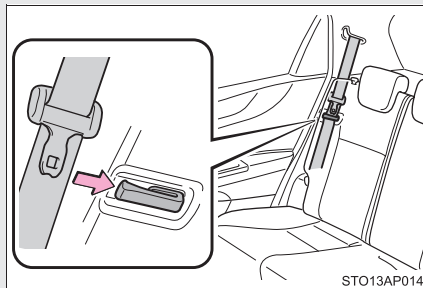

Use the seat belt hangers to prevent the belts from being tangled.

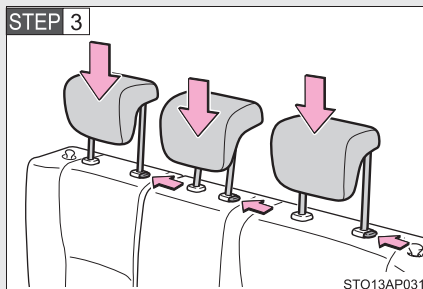

Lower the head restraints to the lowest position.

1

Before driving

*: If equipped

1-3. Adjustable components (seats, mirrors, steering wheel)

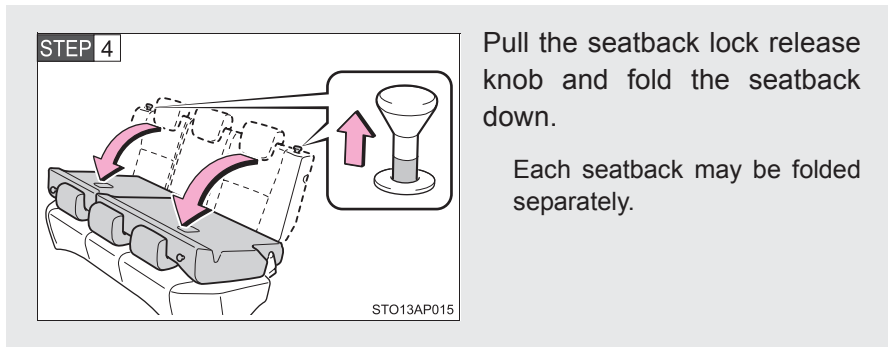

⚠ CAUTION

■ When folding the rear seatbacks down

Observe the following precautions. Failure to do so may result in death or serious injury.

- Do not fold the seatbacks down while driving.
- Stop the vehicle on level ground, set the parking brake and shift the shift lever to P (vehicles with a Multidrive), E, M or R (vehicles with a multi-mode manual transmission) or N (vehicles with a manual transmission).
- Do not allow anyone to sit on a folded seatback or in the luggage compartment while driving.
- Do not allow children to enter the luggage compartment.
- Do not allow anyone sit on the rear center seat if the rear right seat is folded down, as the seat belt buckle for the rear center seat belt is then concealed under the folded seat and cannot be used.
- Be careful not to catch your hand when folding the rear seatbacks.
- Depending on the position of the front seat, it may interfere when trying to fold down the rear seatbacks. If this happens, adjust the position of the front seat.

⚠ CAUTION

■ **After returning the rear seatback to the upright position**

Observe the following precautions. Failure to do so may result in death or serious injury.

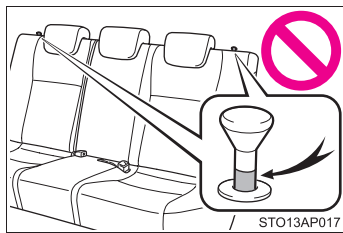

- Make sure that the seatback is securely locked in position by lightly pushing it back and forth. If the seatback is not securely locked, the red marking will be visible on the seatback lock release knob. Make sure that the red marking is not visible.

- Check that the seat belts are not twisted or caught in the seatback.

⚠ NOTICE

■ **Stowing the seat belts**

The seat belts and the buckles must be stowed before you fold down the rear seatbacks.

1-3. Adjustable components (seats, mirrors, steering wheel)

Head restraints

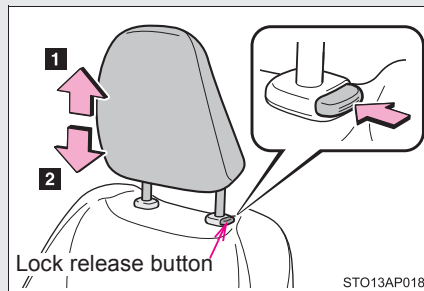

1 Up

Pull the head restraint up.

2 Down

Push the head restraint down while pushing the lock release button.

■ Removing the head restraints

Front and rear center head restraints

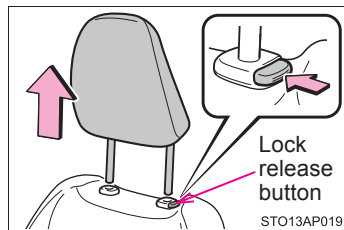

Pull the head restraint up while pressing the lock release button.

Rear outside head restraints

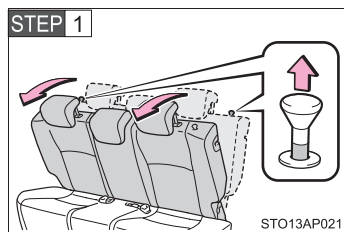

Pull the lock release knob and fold down the seatback until it reaches the position where the head restraints can be removed.

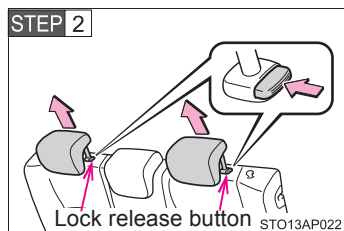

Pull the head restraint up while pushing the lock release button.

■ **Adjusting the height of the front seat head restraints**

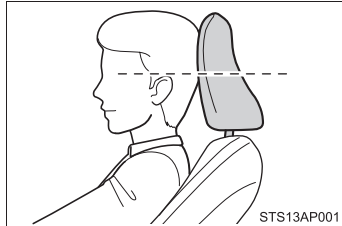

Make sure that the head restraints are adjusted so that the center of the head restraint is closest to the top of your ears.

■ **Adjusting the rear seat head restraints**

Always raise the head restraint one level from the stowed position when using.

⚠ CAUTION

■ **Head restraint precautions**

Observe the following precautions regarding the head restraints. Failure to do so may result in death or serious injury.

- Use the head restraints designed for each respective seat.
- Adjust the head restraints to the correct position at all times.
- After adjusting the head restraints, push down on them and make sure they are locked in position.
- Do not drive with the head restraints removed.

1-3. Adjustable components (seats, mirrors, steering wheel)

Seat belts

Make sure that all occupants are wearing their seat belts before driving the vehicle.

■ Correct use of the seat belts

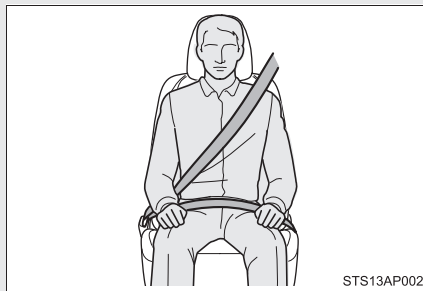

- Extend the shoulder belt so that it comes fully over the shoulder, but does not come into contact with the neck or slide off the shoulder.
- Position the lap belt as low as possible over the hips.
- Adjust the position of the seatback. Sit up straight and well back in the seat.
- Do not twist the seat belt.

■ Fastening and releasing the seat belt

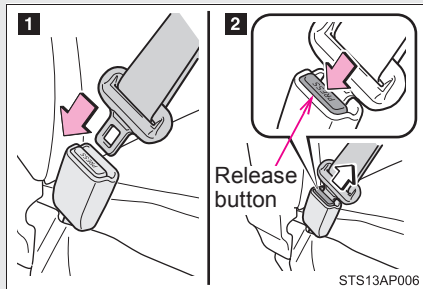

- 1** To fasten the seat belt, push the plate into the buckle until a click sound is heard.
- 2** To release the seat belt, press the release button.

Rear center seat belt

The rear center seat belt is a 3-point type restraint with 2 buckles. Both seat belt buckles must be correctly located and securely latched for proper operation.

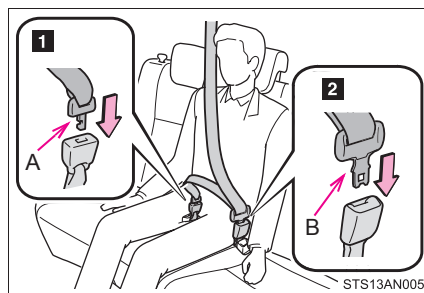

Make sure that the buckle **1** is securely latched ready for use of the center seat belt.

- 1** Matches the tab with hooked end (tab "A").
- 2** Matches the tab with concave end (tab "B").

Release method

The rear center seat belt can be completely released only when necessary such as when folding down the rear seat.

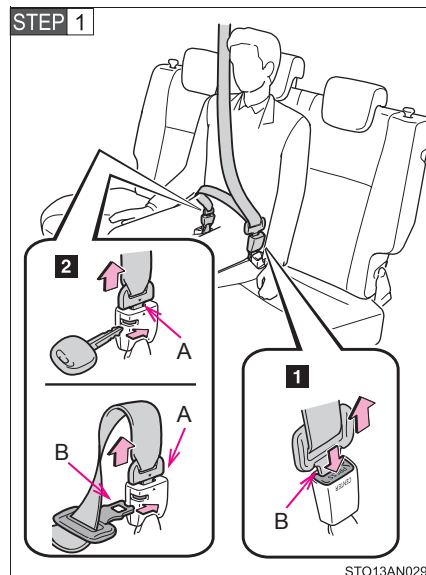

- 1** To release the tab "B", press the release button.
- 2** To release the tab "A", insert the key or tab "B" into the hole on the buckle.

Retract the belt slowly when releasing and stowing the seat belt.

1-3. Adjustable components (seats, mirrors, steering wheel)



Stow the seat belt tabs in the cover set in the roof as shown.

■ **Extracting the belt**

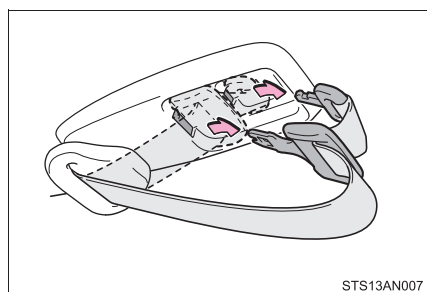

Remove the tabs from the cover.

Seat belt pretensioners (front seats)

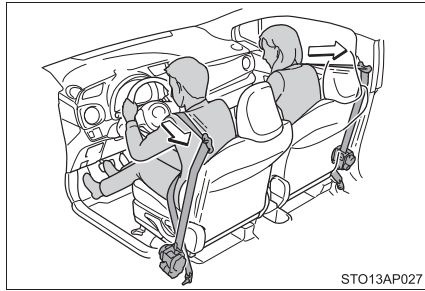

The pretensioner helps the seat belt to quickly restrain the occupant by retracting the seat belt when the vehicle is subjected to certain types of severe frontal collision.

The pretensioner does not activate in the event of a minor frontal impact, a side impact, a rear impact or a vehicle rollover.

1

Before driving

■ Emergency locking retractor (ELR)

The retractor will lock the belt during a sudden stop or on impact. It may also lock if you lean forward too quickly. A slow, easy motion will allow the belt to extend so that you can move around fully.

■ Pregnant women



Obtain medical advice and wear the seat belt in the proper way. (→P. 84)

Women who are pregnant should position the lap belt as low as possible over the hips in the same manner as other occupants. Extend the shoulder belt completely over the shoulder and position the belt across the chest. Avoid belt contact over the rounding of the abdominal area.

If the seat belt is not worn properly, not only the pregnant woman, but also the fetus could suffer death or serious injury as a result of sudden braking or a collision.

■ People suffering illness

Obtain medical advice and wear the seat belt in the proper way. (→P. 84)

1-3. Adjustable components (seats, mirrors, steering wheel)

■ Child seat belt usage

The seat belts of your vehicle were principally designed for persons of adult size.

- Use a child restraint system appropriate for the child, until the child becomes large enough to properly wear the vehicle's seat belt. (→P. 125)
- When the child becomes large enough to properly wear the vehicle's seat belt, follow the instructions on P. 84 regarding seat belt usage.

■ Replacing the belt after the pretensioner has been activated

If the vehicle is involved in multiple collisions, the pretensioner will activate for the first collision, but will not activate for the second or subsequent collisions.

■ Seat belt regulations

If seat belt regulations exist in the country where you reside, please contact any authorized Toyota dealer or repairer, or another duly qualified and equipped professional for seat belt replacement or installation.

 CAUTION

Observe the following precautions to reduce the risk of injury in the event of sudden braking, sudden swerving or an accident. Failure to do so may cause death or serious injury.

■ **Wearing a seat belt**

- Ensure that all passengers wear a seat belt.
- Always wear a seat belt properly.
- Each seat belt should be used by one person only. Do not use a seat belt for more than one person at once, including children.
- Toyota recommends that children be seated in the rear seat and always use a seat belt and/or an appropriate child restraint system.
- To achieve a proper seating position, do not recline the seat more than necessary. The seat belt is most effective when the occupants are sitting up straight and well back in the seats.
- Do not wear the shoulder belt under your arm.
- Always wear your seat belt low and snug across your hips.

■ **When children are in the vehicle**

Do not allow children to play with the seat belt. If the seat belt becomes twisted around a child's neck, it may lead to choking or other serious injuries that could result in death.

If this occurs and the buckle cannot be unfastened, scissors should be used to cut the belt.

■ **Seat belt pretensioners**

- Do not place anything, such as a cushion, on the front passenger's seat. The seat belt pretensioner for the front passenger's seat may not activate in the event of a collision.
- If the pretensioner has activated, the SRS warning light will come on. In that case, the seat belt cannot be used again and must be replaced at any authorized Toyota dealer or repairer, or another duly qualified and equipped professional.

⚠ CAUTION

■ Seat belt damage and wear

- Do not damage the seat belts by allowing the belt, plate, or buckle to be jammed in the door.
- Inspect the seat belt system periodically. Check for cuts, fraying, and loose parts. Do not use a damaged seat belt until it is replaced. Damaged seat belts cannot protect an occupant from death or serious injury.
- Ensure that the belt and plate are locked and the belt is not twisted. If the seat belt does not function correctly, immediately contact any authorized Toyota dealer or repairer, or another duly qualified and equipped professional.
- Replace the seat assembly, including the belts, if your vehicle has been involved in a serious accident, even if there is no obvious damage.
- Do not attempt to install, remove, modify, disassemble or dispose of the seat belts. Have any necessary repairs carried out by any authorized Toyota dealer or repairer, or another duly qualified and equipped professional. Inappropriate handling of the pretensioner may prevent it from operating properly, resulting in death or serious injury.

■ When using the rear center seat belt



- Do not use the rear center seat belt with either buckle released. Fastening only one of the buckles may result in death or serious injury in case of sudden braking or a collision.

- Do not allow anyone sit on the rear center seat if the rear right seat is folded down, as the seat belt buckle for the rear center seat belt is then concealed under the folded seat and cannot be used.

1-3. Adjustable components (seats, mirrors, steering wheel) Steering wheel

The steering wheel can be adjusted to a comfortable position.

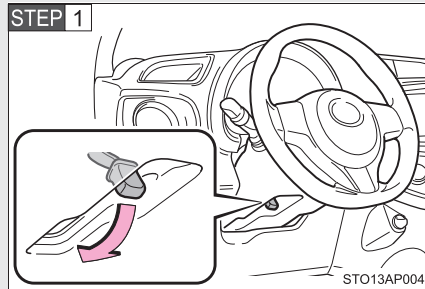

Hold the steering wheel and push the lever down.

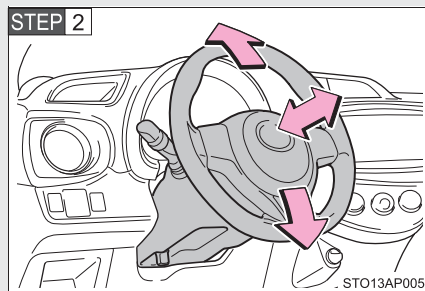

Adjust to the ideal position by moving the steering wheel horizontally and vertically.

After adjustment, pull the lever up to secure the steering wheel.

1

Before driving

CAUTION

■ Caution while driving

Do not adjust the steering wheel while driving. Doing so may cause the driver to mishandle the vehicle and cause an accident, resulting in death or serious injury.

■ After adjusting the steering wheel

Make sure that the steering wheel is securely locked. Otherwise, the steering wheel may move suddenly, possibly causing an accident, and resulting in death or serious injury.

1-3. Adjustable components (seats, mirrors, steering wheel) Anti-glare inside rear view mirror

Glare from the headlights of vehicles behind can be reduced by using the following functions:

Vehicles with a manual anti-glare inside rear view mirror

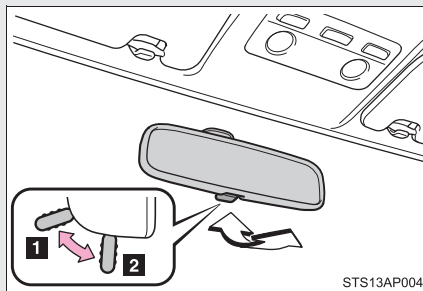

- 1 Normal position
- 2 Anti-glare position

Vehicles with an auto anti-glare inside rear view mirror

In automatic mode, sensors are used to detect the headlights of vehicles behind and the reflected light is automatically reduced.

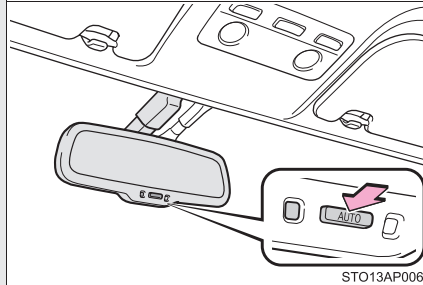

Turns automatic mode on/off

The indicator comes on when automatic mode is turned on.

Vehicles without a smart entry & start system

The mirror will revert to the automatic mode each time the engine switch is turned to the "ON" position.

Vehicles with a smart entry & start system

The mirror will revert to the automatic mode each time the "ENGINE START STOP" switch is turned to IGNITION ON mode.

Adjusting the height of rear view mirror (vehicles with an auto anti-glare inside rear view mirror)

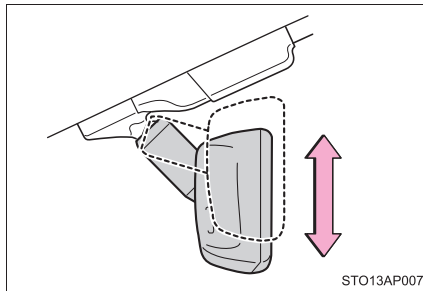

Adjust the height of the rear view mirror by moving it up and down.

1

Before driving

■ To prevent sensor error (vehicles with an auto anti-glare inside rear view mirror)

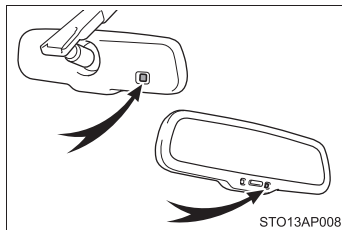

To ensure that the sensors operate properly, do not touch or cover them.

⚠ CAUTION

■ Caution while driving

Do not adjust the position of the mirror while driving. Doing so may lead to mishandling of the vehicle and cause an accident, resulting in death or serious injury.

1-3. Adjustable components (seats, mirrors, steering wheel) Outside rear view mirrors

Mirror angle can be adjusted.

Vehicles with a manually adjustable type

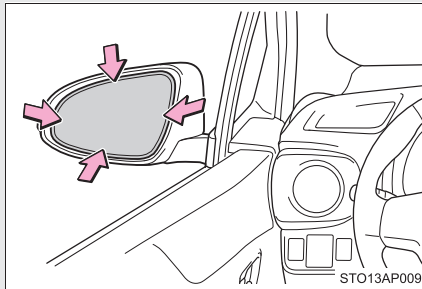

Adjust the mirror up, down, in or out by pushing the mirror surface.

Vehicles with a power-adjustable type

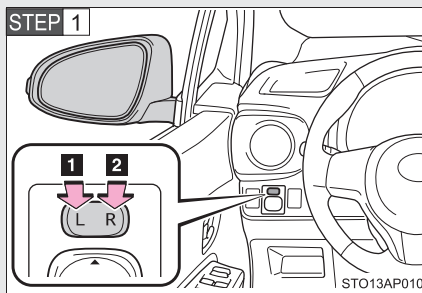

To select a mirror to adjust, press the switch.

- 1 Left
- 2 Right

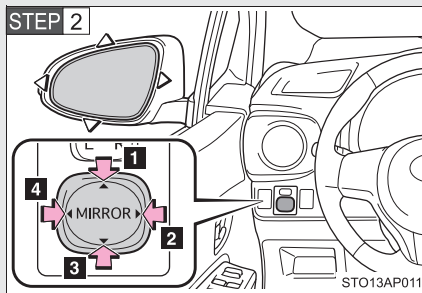

To adjust the mirror, press the switch.

- 1 Up
- 2 Right
- 3 Down
- 4 Left

Folding the mirrors

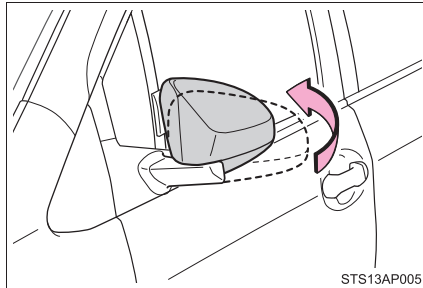

Push the mirror back in the direction of the vehicle's rear.

1

Before driving

■ Mirror operating conditions (vehicles with power-adjustable type)

Vehicles without a smart entry & start system

The engine switch is in the "ACC" or "ON" position.

Vehicles with a smart entry & start system

The "ENGINE START STOP" switch is in ACCESSORY or IGNITION ON mode.

■ When the mirrors are fogged up (vehicles with outside rear view mirror defoggers)

Turn on the mirror defoggers to defog the mirrors. (→P. 285)

1-3. Adjustable components (seats, mirrors, steering wheel)

CAUTION

■ **When driving the vehicle**

Observe the following precautions while driving.

Failure to do so may result in loss of control of the vehicle and cause an accident, resulting in death or serious injury.

- Do not adjust the mirrors while driving.
- Do not drive with the mirrors folded.
- Both the driver and passenger side mirrors must be extended and properly adjusted before driving.

■ **When a mirror is moving (vehicles with power-adjustable type)**

To avoid personal injury and mirror malfunction, be careful not to get your hand caught by the moving mirror.

■ **When the mirror defoggers are operating (vehicles with outside rear view mirror defoggers)**

Do not touch the rear view mirror surfaces, as they can become very hot and burn you.

1-4. Opening and closing the windows Power windows*

The power windows can be opened and closed using the switches.

Operating the switch moves the windows as follows:

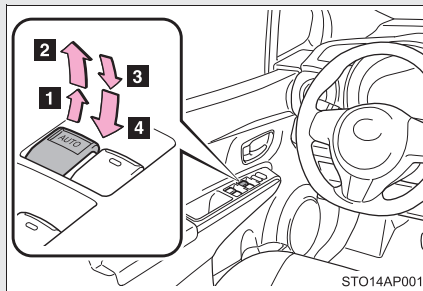

- 1 Closing
- 2 One-touch closing (driver's side only)*
- 3 Opening
- 4 One-touch opening (driver's side only)*

*: Pushing the switch in the opposite direction will stop window travel partway.

1

Before driving

Window lock switch

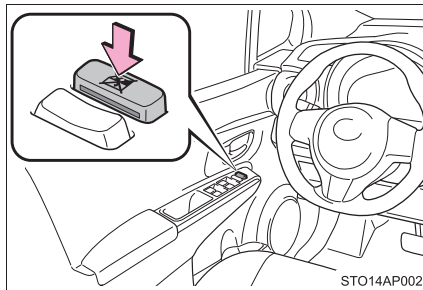

Press the switch down to lock the passenger window switches.

Use this switch to prevent children from accidentally opening or closing a passenger window.

■ The power windows can be operated when

Vehicles without a smart entry & start system

The engine switch is in the "ON" position.

Vehicles with a smart entry & start system

The "ENGINE START STOP" switch is in IGNITION ON mode.

*: If equipped

■ **Operating the power windows after turning the engine off**

Vehicles without a smart entry & start system

The power windows can be operated for approximately 45 seconds even after the engine switch is turned to the “ACC” or “LOCK” position. They cannot, however, be operated once either front door is opened.

Vehicles with a smart entry & start system

The power windows can be operated for approximately 45 seconds even after the “ENGINE START STOP” switch is turned to ACCESSORY mode or turned off. They cannot, however, be operated once either front door is opened.

■ **Jam protection function (driver’s side only)**

If an object becomes caught between the window and the window frame, window travel is stopped and the window is opened slightly.

■ **When the power window does not close normally**

If the jam protection function is operating abnormally and a window cannot be closed, perform the following operations using the power window switch on the driver’s door.

- Vehicles without a smart entry & start system: After stopping the vehicle, the window can be closed by holding the power window switch in the one-touch closing position while the engine switch is turned to the “ON” position.
- Vehicles with a smart entry & start system: After stopping the vehicle, the window can be closed by holding the power window switch in the one-touch closing position while the “ENGINE START STOP” switch is turned to IGNITION ON mode.
- If the window still cannot be closed even by carrying out the operation explained above, initialize the function by performing the following procedure.

STEP 1 Hold the power window switch in the one-touch closing position. Continue holding the switch for a further 6 seconds after the window has closed.

STEP 2 Hold the power window switch in the one-touch opening position. Continue holding the switch for a further 2 seconds after the window has opened completely.

STEP 3 Hold the power window switch in the one-touch closing position once again. Continue holding the switch for a further 2 seconds after the window has closed.

If you release the switch while the window is moving, start again from the beginning.

If the window continues to close but then re-opens slightly even after performing the above procedure correctly, have the vehicle inspected by any authorized Toyota dealer or repairer, or another duly qualified and equipped professional.

 **CAUTION**

■ **Closing the windows**

Observe the following precautions.
Failure to do so may result in death or serious injury.

- Check to make sure that all passengers do not have any part of their body in a position where it could be caught when a window is being operated.
- Do not allow children to operate the power windows.
Closing a power window on someone can cause serious injury, and in some instances, even death.

■ **Jam protection function (driver's side only)**

- Never use any part of your body to intentionally activate the jam protection function.
- The jam protection function may not work if something gets caught just before the window fully closes.

1-5. Refueling

Opening the fuel tank cap

Perform the following steps to open the fuel tank cap:

■ Before refueling the vehicle

Vehicles without a smart entry & start system

Turn the engine switch off and ensure that all the doors and windows are closed.

Vehicles with a smart entry & start system

Turn the "ENGINE START STOP" switch off and ensure that all the doors and windows are closed.

■ Opening the fuel tank cap

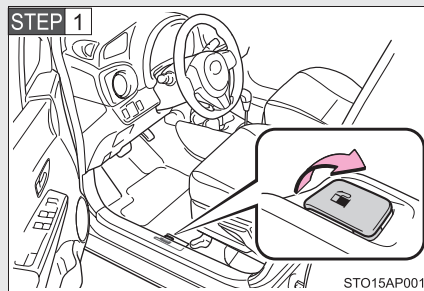

Pull up the opener to open the fuel filler door.

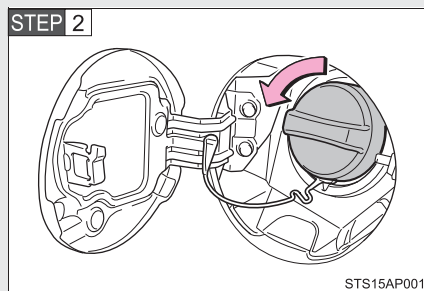

Turn the fuel tank cap slowly to open.

Closing the fuel tank cap

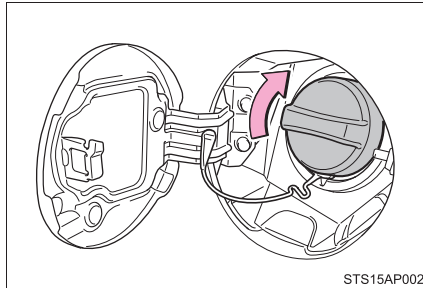

After refueling, turn the fuel tank cap until you hear a click. Once the cap is released, it will turn slightly in the opposite direction.

1

Before driving

■ Fuel types

Gasoline engine

EU area:

Unleaded gasoline conforming to European standard EN228, Research Octane Number of 95 or higher

Except EU area:

Unleaded gasoline, Research Octane Number of 95 or higher

Diesel engine

EU area:

Diesel fuel conforming to European standard EN590

Except EU area:

Diesel fuel that contains 50 ppm or less of sulfur and has a cetane number of 48 or higher

■ Use of ethanol blended gasoline in a gasoline engine

Toyota allows the use of ethanol blended gasoline where the ethanol content is up to 10%. Make sure that the ethanol blended gasoline to be used has a Research Octane Number that follows the above.

■ Fuel tank capacity

Approximately 42 L (11.1 gal., 9.2 Imp. gal.)

 CAUTION

■ **When refueling the vehicle**

Observe the following precautions while refueling the vehicle. Failure to do so may result in death or serious injury.

- After exiting the vehicle and before opening the fuel door, touch an unpainted metal surface to discharge any static electricity. It is important to discharge static electricity before refueling because sparks resulting from static electricity can cause fuel vapors to ignite while refueling.
- Always hold the grips on the fuel tank cap and turn it slowly to remove it. A whooshing sound may be heard when the fuel tank cap is loosened. Wait until the sound cannot be heard before fully removing the cap. In hot weather, pressurized fuel may spray out the filler neck and cause injury.
- Do not allow anyone that has not discharged static electricity from their body to come close to an open fuel tank.
- Do not inhale vaporized fuel.
Fuel contains substances that are harmful if inhaled.
- Do not smoke while refueling the vehicle.
Doing so may cause the fuel to ignite and cause a fire.
- Do not return to the vehicle or touch any person or object that is statically charged.
This may cause static electricity to build up, resulting in a possible ignition hazard.

■ **When refueling**

Securely insert the fuel nozzle into the fuel filler neck. If fuel is added with the nozzle slightly lifted away from the fuel filler neck, the automatic shut off function may not operate, resulting in fuel overflowing from the tank.

■ **When replacing the fuel cap**

Do not use anything but a genuine Toyota fuel tank cap designed for your vehicle. Doing so may cause a fire or other incident which may result in death or serious injury.

 NOTICE

■ **Refueling**

Do not spill fuel during refueling.

Doing so may damage the vehicle, such as causing the emission control system to operate abnormally or damaging fuel system components or the vehicle's painted surface.

1

Before driving

1-6. Theft deterrent system

Engine immobilizer system

The vehicle's keys have built-in transponder chips that prevent the engine from starting if a key has not been previously registered in the vehicle's on-board computer.

Never leave the keys inside the vehicle when you leave the vehicle.

Vehicles without a smart entry & start system: The system begins operating after the key has been removed from the engine switch. The system is canceled after the registered key has been inserted into the engine switch.

Vehicles with a smart entry & start system: The system begins operating after the "ENGINE START STOP" switch has been turned off. The system is canceled after the "ENGINE START STOP" switch has been turned to ACCESSORY or IGNITION ON mode.

■ System maintenance

The vehicle has a maintenance-free type engine immobilizer system.

■ Conditions that may cause the system to malfunction

- If the grip portion of the key is in contact with a metallic object
- If the key is in close proximity to or touching a key to the security system (key with a built-in transponder chip) of another vehicle

■ **Certification for the engine immobilizer system (vehicles without a smart entry & start system)**

“Hereby, TRCZ s.r.o., declares that this RI-37BTY is in compliance with the essential requirements and other relevant provisions of Directive 1999/5/EC.”

1

Before driving

TRCZ

R&TTE Declaration of Conformity

We,

Manufacturer's Name: TRCZ s.r.o.
 Manufacturer's Address: Prumyslova 1165, 410 02, Lovosice, Czech Republic

hereby declare under our sole responsibility that the product:

Product Name: Immobilizer
 Product Model: RI-37BTY

to which this declaration relates is in conformity with the essential requirements and other relevant requirements of the R&TTE Directive (1999/5/EC). The product is compliant with the following standards and/or other normative documents:

Safety: EN60950-1
 EMC: EN301 489-1 & -3
 Spectrum: EN300 330-2

Supplementary information:

* CE mark	CE
* Member states intended for use	EU and EFTA
* Member states with restrictive use	None

Date: 6 September 2010

Signature: 

Position of the signatory: Yasuo Miyake
 Plant manager

1-6. Theft deterrent system

“Hereby, TRCZ s.r.o., declares that this RI-37BTY is in compliance with the essential requirements and other relevant provisions of Directive 1999/5/EC.”

“Ovim, TRCZ s.r.o., izjavljuje da ovaj RI-37BTY je usklađen sa bitnim zahtjevima i drugim relevantnim odredbama Direktive 1999/5/EC.”

NOTICE

■ **To ensure the system operates correctly**

Do not modify or remove the system. If modified or removed, the proper operation of the system cannot be guaranteed.

1-6. Theft deterrent system Double locking system*

Unauthorized access to the vehicle is prevented by disabling the door unlocking function from both the interior and exterior of the vehicle.

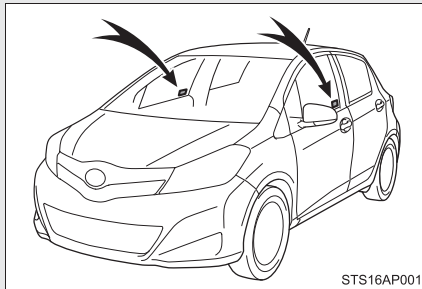

Vehicles employing this system have labels on the window glass of both front doors.

1

Before driving

Setting the double locking system

Vehicles without a smart entry & start system: Turn the engine switch off, have all the passengers exit the vehicle and ensure that all the doors are closed.

Vehicles with a smart entry & start system: Turn the “ENGINE START STOP” switch off, have all the passengers exit the vehicle and ensure that all the doors are closed.

Using the entry function (vehicles with a smart entry & start system): Touch the sensor area on the outside door handle twice within 5 seconds.

Using the wireless remote control: Press  twice within 5 seconds.

Canceling the double locking system

Using the entry function (vehicles with a smart entry & start system): Hold either front outside door handle or push up the back door opener switch.

Using the wireless remote control: Press  .

*: If equipped

1-6. Theft deterrent system

CAUTION

■ Double locking system precaution

Never activate the double locking system when there are people in the vehicle because all the doors cannot be opened from inside the vehicle.

1-7. Safety information

Correct driving posture

Drive with a good posture as follows:

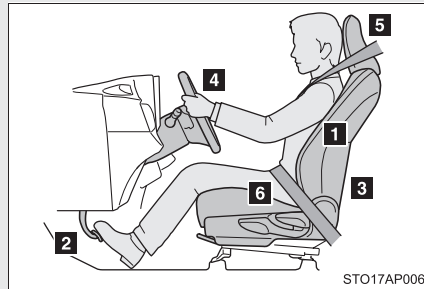

- 1 Sit upright and well back in the seat. (→P. 76)
- 2 Adjust the position of the seat forward or backward to ensure the pedals can be reached and easily depressed to the extent required. (→P. 76)
- 3 Adjust the seatback so that the controls are easily operable. (→P. 76)
- 4 Adjust the tilt and telescopic positions of the steering wheel downward so the airbag is facing your chest. (→P. 91)
- 5 Lock the head restraint in place with the center of the head restraint closest to the top of your ears. (→P. 82)
- 6 Wear the seat belt correctly. (→P. 84)

1

Before driving

 CAUTION

■ **While driving**

- Do not adjust the position of the driver's seat.
Doing so could cause the driver to lose control of the vehicle.
- Do not place a cushion between the driver or passenger and the seatback.
A cushion may prevent correct posture from being achieved, and reduce the effectiveness of the seat belt and head restraint, increasing the risk of death or serious injury to the driver or passenger.
- Do not place anything under the front seats.
Objects placed under the front seats may become jammed in the seat tracks and stop the seat from locking in place. This may lead to an accident, resulting in death or serious injury. The adjustment mechanism may also be damaged.

■ **Adjusting the seat position**

- Take care when adjusting the seat position to ensure that other passengers are not injured by the moving seat.
- Do not put your hands under the seat or near the moving parts to avoid injury.
Fingers or hands may become jammed in the seat mechanism.

1-7. Safety information

SRS airbags

The SRS airbags inflate when the vehicle is subjected to certain types of severe impacts that may cause significant injury to the occupants. They work together with the seat belts to help reduce the risk of death or serious injury.

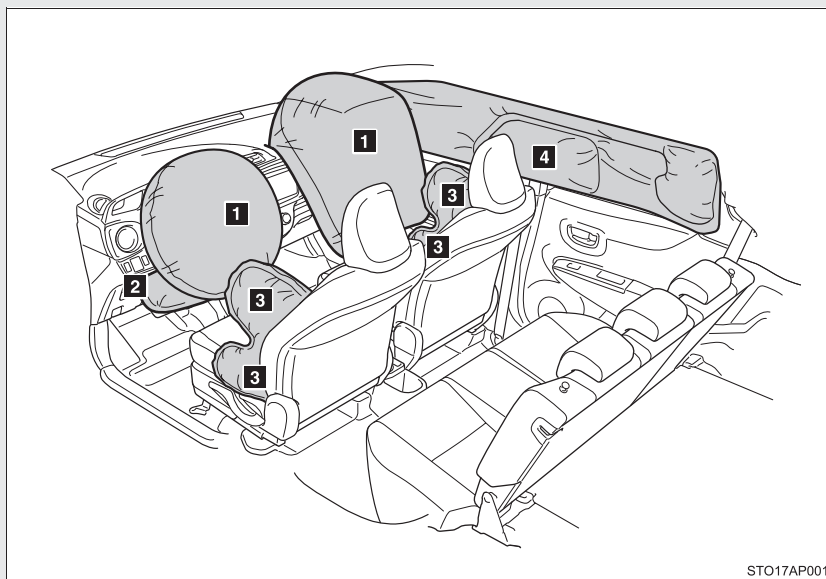

SRS front airbags

- 1** SRS driver airbag/front passenger airbag
Can help protect the head and chest of the driver and front passenger from impact with interior components
- 2** SRS driver knee airbag (if equipped)
Can help provide driver protection

SRS side and curtain shield airbags

- 3** SRS side airbags
Can help protect the torso of the front seat occupants
- 4** SRS curtain shield airbags (if equipped)
Can help protect primarily the head of occupants in the outer seats

1

Before driving

SRS airbag system components

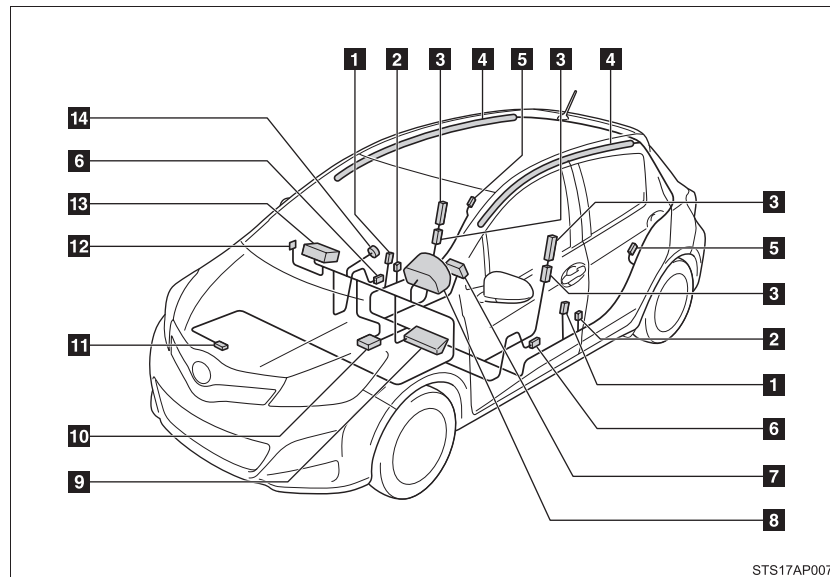

- | | |
|--|---|
| 1 Seat belt pretensioners | 7 Driver airbag |
| 2 5-door models: Side impact sensors (front) | 8 SRS warning light |
| 3 Side airbags | 9 Driver knee airbag (if equipped) |
| 4 Curtain shield airbags (if equipped) | 10 Airbag sensor assembly |
| 5 Side impact sensors (rear) (if equipped) | 11 Front impact sensor |
| 6 3-door models: Side impact sensors (front door) | 12 Airbag manual on-off switch |
| | 13 Front passenger airbag |
| | 14 "PASSENGER AIR BAG" indicator |

The main SRS airbag system components are shown above. The SRS airbag system is controlled by the airbag sensor assembly. As the airbags deploy, a chemical reaction in the inflators quickly fills the airbags with non-toxic gas to help restrain the motion of the occupants.

■ If the SRS airbags deploy (inflate)

- Bruising and slight abrasions may result from contact with a deploying (inflating) SRS airbag.
- A loud noise and white powder will be emitted.
- Parts of the airbag module (steering wheel hub, airbag cover and inflator) as well as the front seats, parts of the front and rear pillars, and roof side rails, may be hot for several minutes. The airbag itself may also be hot.
- The windshield may crack.

■ SRS airbag deployment conditions (SRS front airbags)

- The SRS front airbags will deploy in the event of an impact that exceeds the set threshold level (the level of force corresponding to an approximately 20 - 30 km/h [12 - 18 mph] frontal collision with a fixed wall that does not move or deform).

However, this threshold velocity will be considerably higher if the vehicle strikes an object, such as a parked vehicle and sign pole, which can move or deform on impact, or if the vehicle is involved in an underride collision (e.g. a collision in which the front of the vehicle “underrides”, or goes under, the bed of a truck etc.).

- It is possible that in some collisions where the forward deceleration of the vehicle is very close to the designed threshold level, the SRS front airbags and the seat belt pretensioners may not activate together.

■ SRS airbag deployment conditions (SRS side and curtain shield airbags [if equipped])

The SRS side and curtain shield airbags will deploy in the event of an impact that exceeds the set threshold level (the level of force corresponding to the impact force produced by an approximately 1500 kg [3300 lb.] vehicle colliding with the vehicle cabin from a direction perpendicular to the vehicle orientation at an approximate speed of 20 - 30 km/h [12 - 18 mph]).

■ **Conditions under which the SRS airbags may deploy (inflate), other than a collision**

The SRS front airbags may also deploy if a serious impact occurs to the underside of your vehicle. Some examples are shown in the illustration.

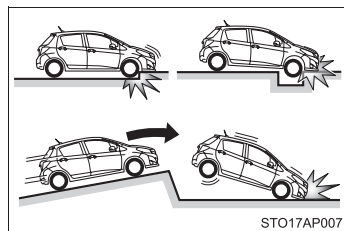

- Hitting a curb, edge of pavement or hard surface
- Falling into or jumping over a deep hole
- Landing hard or falling

■ **Types of collisions that may not deploy the SRS airbags (SRS front airbags)**

The SRS front airbags do not generally inflate if the vehicle is involved in a side or rear collision, if it rolls over, or if it is involved in a low-speed frontal collision. But, whenever a collision of any type causes sufficient forward deceleration of the vehicle, deployment of the SRS front airbags may occur.

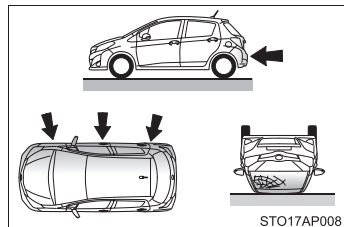

- Collision from the side
- Collision from the rear
- Vehicle rollover

■ Types of collisions that may not deploy the SRS airbags (SRS side and curtain shield airbags [if equipped])

The SRS side and curtain shield airbags may not activate if the vehicle is subjected to a collision from the side at certain angles, or a collision to the side of the vehicle body other than the passenger compartment.

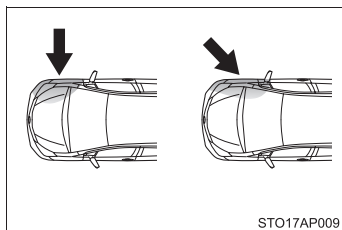

STO17AP009

- Collision from the side to the vehicle body other than the passenger compartment
- Collision from the side at an angle

The SRS side and curtain shield airbags do not generally inflate if the vehicle is involved in a frontal or rear collision, if it rolls over, or if it is involved in a low-speed side collision.

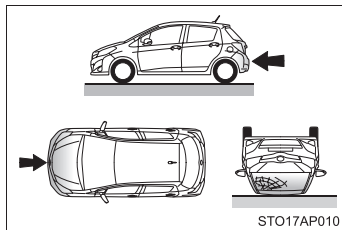

STO17AP010

- Collision from the front
- Collision from the rear
- Vehicle rollover

■ When to contact any authorized Toyota dealer or repairer, or another duly qualified and equipped professional

In the following cases, contact any authorized Toyota dealer or repairer, or another duly qualified and equipped professional as soon as possible.

- Any of the SRS airbags have been inflated.

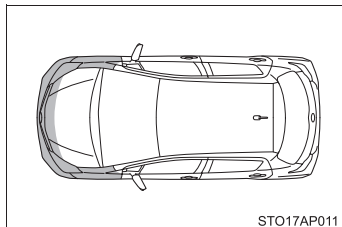

STO17AP011

- The front of the vehicle is damaged or deformed, or was involved in an accident that was not severe enough to cause the SRS front airbags to inflate.

1-7. Safety information

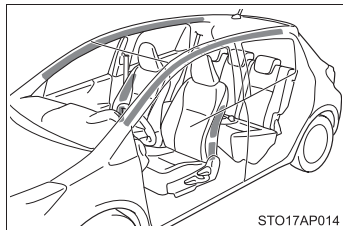
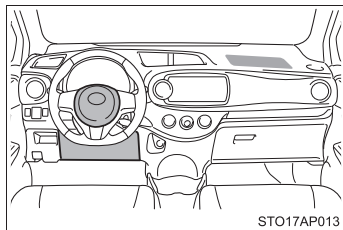
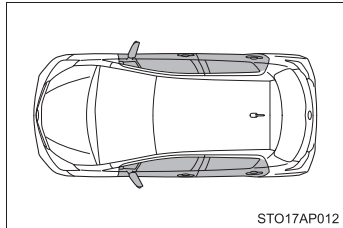

- A portion of a door is damaged or deformed, or the vehicle was involved in an accident that was not severe enough to cause the SRS side and curtain shield airbags (if equipped) to inflate.
- Vehicles without an SRS driver knee airbag: The pad section of the steering wheel or dashboard near the front passenger airbag is scratched, cracked, or otherwise damaged.
- Vehicles with an SRS driver knee airbag: The pad section of the steering wheel, dashboard near the front passenger airbag or lower portion of the instrument panel is scratched, cracked, or otherwise damaged.
- The surface of the seats with the side airbag is scratched, cracked, or otherwise damaged.
- Vehicles with SRS curtain shield airbags: The portion of the front pillars, rear pillars or roof side rail garnishes (padding) containing the curtain shield airbags is inside scratched, cracked, or otherwise damaged.

⚠ CAUTION**■ SRS airbag precautions**

Observe the following precautions regarding the SRS airbags. Failure to do so may cause death or serious injury.

- The driver and all passengers in the vehicle must wear their seat belts properly.

The SRS airbags are supplemental devices to be used with the seat belts.

- The SRS driver airbag deploys with considerable force, and can cause death or serious injury especially if the driver is very close to the airbag.

Since the risk zone for the driver's airbag is the first 50 - 75 mm (2 - 3 in.) of inflation, placing yourself 250 mm (10 in.) from your driver airbag provides you with a clear margin of safety. This distance is measured from the center of the steering wheel to your breastbone. If you sit less than 250 mm (10 in.) away now, you can change your driving position in several ways:

- Move your seat to the rear as far as you can while still reaching the pedals comfortably.
- Slightly recline the back of the seat. Although vehicle designs vary, many drivers can achieve the 250 mm (10 in.) distance, even with the driver seat all the way forward, simply by reclining the back of the seat somewhat. If reclining the back of your seat makes it hard to see the road, raise yourself by using a firm, non-slippery cushion, or raise the seat if your vehicle has that feature.
- If your steering wheel is adjustable, tilt it downward. This points the airbag toward your chest instead of your head and neck.

The seat should be adjusted as recommended above, while still maintaining control of the foot pedals, steering wheel, and your view of the instrument panel controls.

- The SRS front passenger airbag also deploys with considerable force, and can cause death or serious injury especially if the front passenger is very close to the airbag. The front passenger seat should be as far from the airbag as possible with the seatback adjusted, so the front passenger sits upright.

1

Before driving

⚠ CAUTION

■ SRS airbag precautions

● Improperly seated and/or restrained infants and children can be killed or seriously injured by a deploying airbag. An infant or child who is too small to use a seat belt should be properly secured using a child restraint system. Toyota strongly recommends that all infants and children be placed in the rear seats of the vehicle and properly restrained. The rear seats are safer for infants and children than the front passenger seat. (→P. 125)

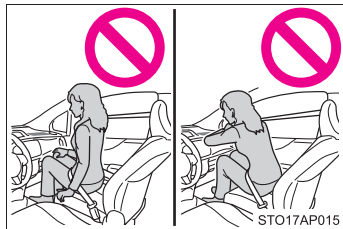

● Do not sit on the edge of the seat or lean against the dashboard.

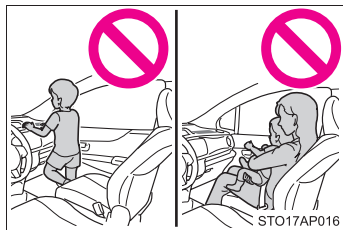

● Do not allow a child to stand in front of the SRS front passenger airbag unit or sit on the knees of a front passenger.

● Do not allow the front seat occupants to hold items on their knees.



● Vehicles without SRS curtain shield airbags: Do not lean against the front door.

● Vehicles with SRS curtain shield airbags: Do not lean against the door, the roof side rail or the front, side and rear pillars.

⚠ CAUTION**■ SRS airbag precautions**

- Do not allow anyone to kneel on the passenger seat toward the door or put their head or hands outside the vehicle.

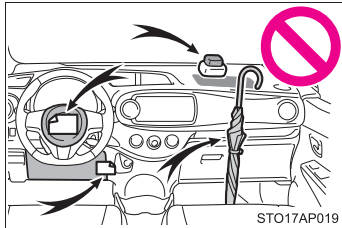

- Vehicles without an SRS driver knee airbag: Do not attach anything to or lean anything against areas such as the dashboard or steering wheel pad. These items can become projectiles when the SRS driver and front passenger airbags deploy.

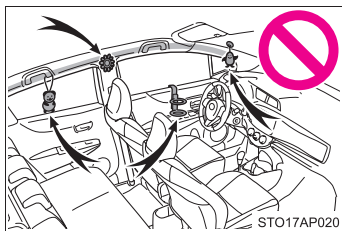

- Vehicles with an SRS driver knee airbag: Do not attach anything to or lean anything against areas such as the dashboard, steering wheel pad and lower portion of the instrument panel. These items can become projectiles when the SRS driver, front passenger and driver knee airbags deploy.
- Vehicles without SRS curtain shield airbags: Do not attach anything to areas such as a door, windshield glass and side door glass.
- Vehicles with SRS curtain shield airbags: Do not attach anything to areas such as a door, windshield glass, side door glass, front or rear pillar, roof side rail and assist grip.

⚠ CAUTION

■ SRS airbag precautions

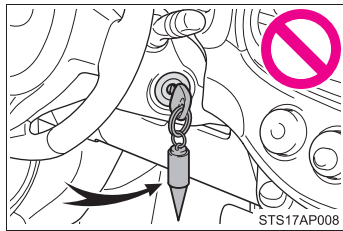

- Vehicles with an SRS driver knee airbag and vehicles without a smart entry & start system: Do not attach any heavy, sharp or hard objects such as keys and accessories to the key. The objects may restrict the SRS driver knee airbag inflation or be thrust into the driver's seat area by the force of the deploying airbag, thus causing a danger.
- Vehicles with SRS curtain shield airbags: Do not hang coat hangers or other hard objects on the coat hooks. All of these items could become projectiles and may cause death or serious injury, should the SRS curtain shield airbags deploy.
- Vehicles with an SRS driver knee airbag: If a vinyl cover is put on the area where the SRS driver knee airbag will deploy, be sure to remove it.
- Do not use seat accessories which cover the parts where the SRS side airbags inflate as they may interfere with inflation of the airbags. Such accessories may prevent the side airbags from activating correctly, disable the system or cause the side airbags to inflate accidentally, resulting in death or serious injury.
- Do not strike or apply significant levels of force to the area of the SRS airbag components.
Doing so can cause the SRS airbags to malfunction.
- Do not touch any of the component parts immediately after the SRS airbags have deployed (inflated) as they may be hot.
- If breathing becomes difficult after the SRS airbags have deployed, open a door or window to allow fresh air in, or leave the vehicle if it is safe to do so. Wash off any residue as soon as possible to prevent skin irritation.
- Vehicles without SRS curtain shield airbags: If the areas where the SRS airbags are stored, such as the steering wheel pad, are damaged or cracked, have them replaced by any authorized Toyota dealer or repairer, or another duly qualified and equipped professional.

⚠ CAUTION**■ SRS airbag precautions**

- Vehicles with SRS curtain shield airbags: If the areas where the SRS airbags are stored, such as the steering wheel pad and front and rear pillar garnishes, are damaged or cracked, have them replaced by any authorized Toyota dealer or repairer, or another duly qualified and equipped professional.

■ Modification and disposal of SRS airbag system components

Do not dispose of your vehicle or perform any of the following modifications without consulting any authorized Toyota dealer or repairer, or another duly qualified and equipped professional. The SRS airbags may malfunction or deploy (inflate) accidentally, causing death or serious injury.

- Installation, removal, disassembly and repair of the SRS airbags
- Repairs, modifications, removal or replacement of the steering wheel, instrument panel, dashboard, seats or seat upholstery, front, side and rear pillars or roof side rails
- Repairs or modifications of the front fender, front bumper, or side of the occupant compartment
- Installation of snow plows, winches, etc. to the front grille (bull bars, or kangaroo bar etc.)
- Modifications to the vehicle's suspension system
- Installation of electronic devices such as an RF-transmitter and CD players

1

Before driving

1-7. Safety information

Airbag manual on-off system

This system deactivates the front passenger airbag.
Only deactivate the airbags when using a child restraint system on the front passenger seat.

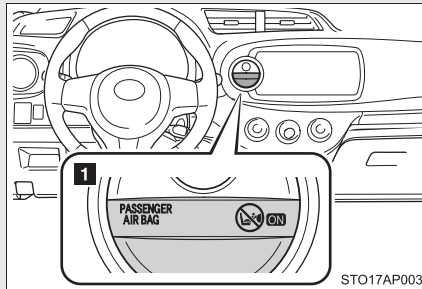

1 "PASSENGER AIR BAG" indicator

Vehicles without a smart entry & start system

This indicator light turns on when the airbag system is on (only when the engine switch is in the "ON" position).

Vehicles with a smart entry & start system

This indicator light turns on when the airbag system is on (only when the "ENGINE START STOP" switch is in IGNITION ON mode).

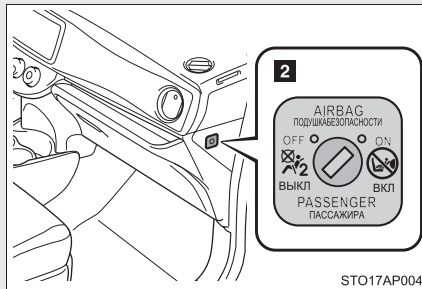

2 Airbag manual on-off switch

Deactivating the front seat passenger airbag

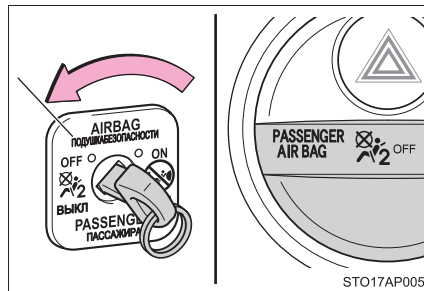

Vehicles without a smart entry & start system

Insert the key into the cylinder and turn to the “OFF” position.

The “OFF” indicator light turns on (only when the engine switch is in the “ON” position).

Vehicles with a smart entry & start system

Insert the mechanical key into the cylinder and turn to the “OFF” position.

The “OFF” indicator light turns on (only when the “ENGINE START STOP” switch is in IGNITION ON mode).

1

Before driving

■ “PASSENGER AIR BAG” indicator information

If any of the following problems occur, it is possible that there is a malfunction in the system. Have the vehicle inspected by any authorized Toyota dealer or repairer, or another duly qualified and equipped professional.

- Neither “ON” nor “OFF” comes on.
- The indicator light does not change when the airbag manual on-off switch is switched to “ON” or “OFF”.

 CAUTION

■ **When installing a child restraint system**

For safety reasons, always install a child restraint system in a rear seat. In the event that the rear seat cannot be used, the front seat can be used as long as the airbag manual on-off system is set to “OFF”.

If the airbag manual on-off system is left “ON”, the strong impact of the airbag deployment (inflation) may cause serious injury or even death.

■ **When a child restraint system is not installed on the front passenger seat**

Ensure that the airbag manual on-off system is set to “ON”.

If it is left “OFF”, the airbag may not deploy in the event of an accident, which may result in serious injury or even death.

1-7. Safety information

Child restraint systems

Toyota strongly urges the use of child restraint systems.

Points to remember

Studies have shown that installing a child restraint on a rear seat is much safer than installing one on the front passenger seat.

- Choose a child restraint system that suits your vehicle and is appropriate to the age and size of the child.
- For installation details, follow the instructions provided with the child restraint system.
General installation instructions are provided in this manual.
(→P. 134)
- If child restraint system regulations exist in the country where you reside, please contact any authorized Toyota dealer or repairer, or another duly qualified and equipped professional for the child restraint system installation.
- Toyota recommends that you use a child restraint system which conforms to the regulation ECE No.44.

Types of child restraints

Child restraint systems are classified into the following 5 groups according to the regulation ECE No.44:

Group 0:Up to 10 kg (22 lb.) (0 - 9 months)

Group 0⁺:Up to 13 kg (28 lb.) (0 - 2 years)

Group I:9 to 18 kg (20 to 39 lb.) (9 months - 4 years)

Group II:15 to 25 kg (34 to 55 lb.) (4 years - 7 years)

Group III:22 to 36 kg (49 to 79 lb.) (6 years - 12 years)

In this owner's manual, the following 3 types of popular child restraint systems that can be secured with the seat belts are explained:

1

Before driving

1-7. Safety information

Baby seat

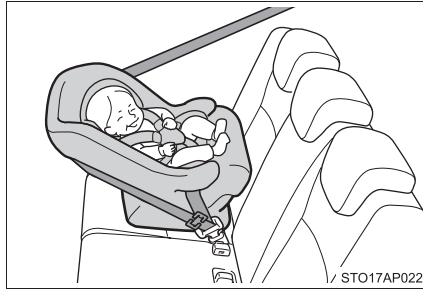

Equal to Group 0 and 0⁺ of ECE No.44

Child seat



Equal to Group 0⁺ and I of ECE No.44

Junior seat



Equal to Group II and III of ECE No.44

Child restraint system suitability for various seating positions

Information provided in the table shows your child restraint system suitability for various seating positions.

Seating position Mass groups	Front passenger seat		Rear seat	
	Airbag manual on-off switch		Outside	Center
	ON	OFF		
0 Up to 10 kg (22 lb.) (0 - 9 months)	X Never put	L1, L2, L3	U	L1, L2
0 ⁺ Up to 13 kg (28 lb.) (0 - 2 years)	X Never put	L1, L2, L3	U	L1, L2
I 9 to 18 kg (20 to 39 lb.) (9 months - 4 years)	Rear-facing — X Never put	UF*1	U	L4*2
	Forward-facing — UF*1			
II, III 15 to 36 kg (34 to 79 lb.) (4 - 12 years)	UF*1	UF*1	U	L5*2, L6*2

1

Before driving

Key of letters inserted in the above table:

- U: Suitable for “universal” category child restraint system approved for the use in this mass group.
- UF: Suitable for forward-facing “universal” category child restraint system approved for the use in this mass group.
- L1: Suitable for “TOYOTA G 0+, BABYSAFE” (0 to 13 kg [0 to 28 lb.]) approved for the use in this mass group.
- L2: Suitable for “TOYOTA G 0+, BABYSAFE PLUS” (0 to 13 kg [0 to 28 lb.]) approved for the use in this mass group.
- L3: Suitable for “TOYOTA G 0+, BABYSAFE PLUS with SEAT BELT FIXATION, BASE PLATFORM” (0 to 13 kg [0 to 28 lb.]) approved for the use in this mass group.
- L4: Suitable for “TOYOTA DUO+” (without ISOFIX, 9 to 18 kg [20 to 39 lb.]) approved for the use in this mass group.
- L5: Suitable for “TOYOTA KID” (15 to 36 kg [34 to 79 lb.]) approved for the use in this mass group.
- L6: Suitable for “TOYOTA KIDFIX” (15 to 36 kg [34 to 79 lb.]) approved for the use in this mass group.
- X: Not suitable seat position for children in this mass group.
- *1: Adjust the front seat back to the most upright position. Move the front seat cushion to the fully rearward.
- *2: When you use a child restraint system in this position, remove the head restraint.

The child restraint systems mentioned in the table may not be available outside of the EU area. Other child restraint systems which is different from the systems mentioned in the table can be used, but the suitability of the systems must be carefully checked with the child restraint system manufacturer concerned and the seller of those seats.

**Child restraint system suitability for various seating positions
(with ISOFIX rigid anchors)**

Information provided in the table shows your child restraint system suitability for various seating positions.

Mass groups	Size class	Fixture	Vehicle ISOFIX positions
			Rear outside
Carrycot	F	ISO/L1	X
	G	ISO/L2	X
		(1)	X
Group 0 Up to 10 kg (22 lb.)	E	ISO/R1	IL1* ¹
		(1)	X
Group 0 ⁺ Up to 13 kg (28 lb.)	E	ISO/R1	IL1* ¹
	D	ISO/R2	X
	C	ISO/R3	X
		(1)	X
Group I* ³ 9 to 18 kg (20 to 39 lb.)	D	ISO/R2	X
	C	ISO/R3	X
	B	ISO/F2	IUF* ²
	B1	ISO/F2X	IUF* ²
	A	ISO/F3	IUF* ²
		(1)	X
Group II 15 to 25 kg (34 to 55 lb.)		(1)	X
Group III 22 to 36 kg (49 to 79 lb.)		(1)	X

1

Before driving

1-7. Safety information

- (1) For the CRS which do not carry the ISO/XX size class identification (A to G), for the applicable mass group, the car manufacturer shall indicate the vehicle specific ISOFIX child restraint system(s) recommended for each position.

Key of letters inserted in the above table:

IUF: Suitable for ISOFIX forward-facing child restraints systems of universal category approved for the use in this mass group.

IL1: Suitable for "TOYOTA G 0+, BABYSAFE PLUS with ISO-FIX FIXATION, BASE PLATFORM" (0 to 13 kg [0 to 28 lb.]) approved for the use in this mass group.

X: ISOFIX position not suitable for ISOFIX child restraint systems in this mass group and/or this size class.

*1: If the child seat is installed behind a front seat equipped with height adjuster and the front seat is adjusted below middle height position, then adjust the front seat head restraint to the highest position.

*2: When you use a child restraint system in this position, remove the head restraint.

*3: Toyota recommend to use "TOYOTA DUO+" (with ISOFIX and TOP TETHER, 9 to 18 kg [20 to 39 lb.]) approved for the use in this mass group. When using this child seat, adjust it to the most reclined position.

The child restraint systems mentioned in the table may not be available outside of the EU area. Other child restraint systems different from the systems mentioned in the table can be used, but the suitability of the systems must be carefully checked with the child restraint system manufacturer and retailer.

■ When installing the child restraint system on the front passenger seat

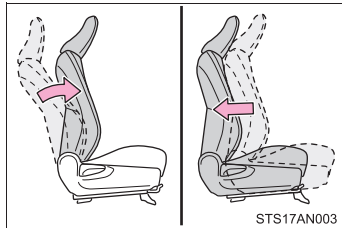

When you have to use a child restraint system on the front passenger seat, adjust the following:

- The seatback to the most upright position
- The seat as far back as possible

■ Selecting an appropriate child restraint system

- Use a child restraint system appropriate for the child until the child becomes large enough to properly wear the vehicle's seat belt.
- If the child is too large for a child restraint system, sit the child on a rear seat and use the vehicle's seat belt. (→P. 84)

⚠ CAUTION

■ Using a child restraint system

The use of a child restraint system not suitable for the vehicle may not properly secure the infant or child. It may result in death or serious injury (in the event of sudden braking or an accident).

■ Child restraint precautions

- For effective protection in automobile accidents and sudden stops, a child must be properly restrained, using a seat belt or child restraint system depending on the age and size of the child. Holding a child in your arms is not a substitute for a child restraint system. In an accident, the child can be crushed against the windshield, or between you and the vehicle's interior.
- Toyota strongly urges the use of a proper child restraint system that conforms to the size of the child, installed on the rear seat. According to accident statistics, the child is safer when properly restrained in the rear seat than in the front seat.

 CAUTION

■ **Child restraint precautions**

- Never use a rear-facing child restraint system on the front passenger seat when the airbag manual on-off switch is on. (→P. 122)
In the event of an accident, the force of the rapid inflation of the front passenger airbag can cause death or serious injury to the child.
- A forward-facing child restraint system may be installed on the front passenger seat only when it is unavoidable. A child restraint system that requires a top tether strap should not be used in the front passenger seat since there is no top tether strap anchor for the front passenger seat. Adjust the seatback as upright as possible and always move the seat as far back as possible because the front passenger airbag could inflate with considerable speed and force. Otherwise, the child may be killed or seriously injured.
- Vehicles without SRS curtain shield airbags: Do not allow the child to lean his/her head or any part of his/her body against the door or the area of the seat from which the SRS side airbags deploy even if the child is seated in the child restraint system. It is dangerous if the SRS side airbags inflate, and the impact could cause death or serious injury to the child.
- Vehicles with SRS curtain shield airbags: Do not allow the child to lean his/her head or any part of his/her body against the door or the area of the seat, front and rear pillars or roof side rails from which the SRS side airbags or SRS curtain shield airbags deploy even if the child is seated in the child restraint system. It is dangerous if the SRS side airbags and curtain shield airbags inflate, and the impact could cause death or serious injury to the child.
- Make sure you have complied with all installation instructions provided by the child restraint manufacturer and that the system is properly secured. If it is not secured properly, it may cause death or serious injury to the child in the event of a sudden stop, sudden swerve or an accident.

 CAUTION**■ When children are in the vehicle**

Do not allow children to play with the seat belt. If the seat belt becomes twisted around a child's neck, it may lead to choking or other serious injuries that may result in death.

If this occurs and the buckle cannot be unfastened, scissors should be used to cut the belt.

■ When the child restraint system is not in use

- Keep the child restraint system properly secured on the seat even if it is not in use. Do not store the child restraint system unsecured in the passenger compartment.
- If it is necessary to detach the child restraint system, remove it from the vehicle or store it securely in the luggage compartment. This will prevent it from injuring passengers in the event of a sudden stop, sudden swerve or accident.

1

Before driving

1-7. Safety information

Installing child restraints

Follow the child restraint system manufacturer's instructions. Firmly secure child restraints to the seats using a seat belt or ISOFIX rigid anchors. Attach the top strap when installing a child restraint.

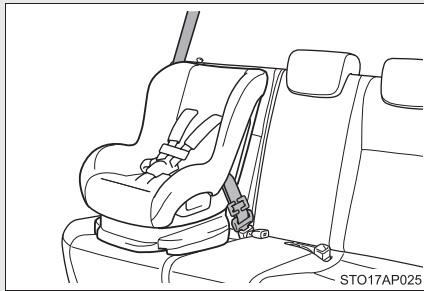

Seat belts (An ELR belt requires a locking clip.)

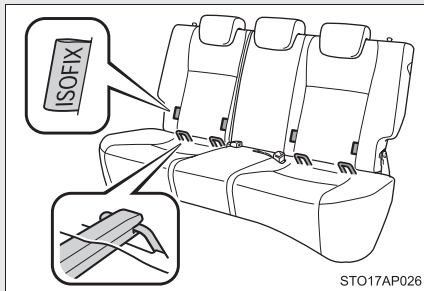

Vehicles with rear seats: ISOFIX rigid anchors (ISOFIX child restraint system)

Lower anchors are provided for outside rear seats. (Tags displaying the location of the anchors are attached to the seats.)

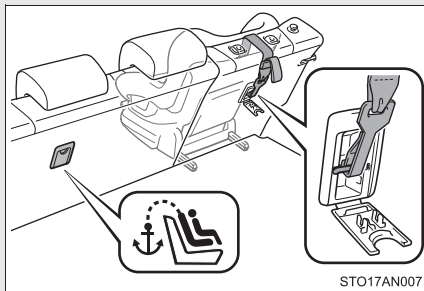

Vehicles with rear seats: Anchor brackets (for the top strap)

Anchor brackets are provided for outside rear seats.

Installing child restraints using a seat belt

■ Rear facing — Baby seat/child seat

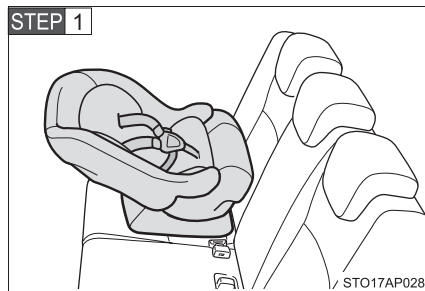

Place the child restraint system on the rear seat facing the rear of the vehicle.

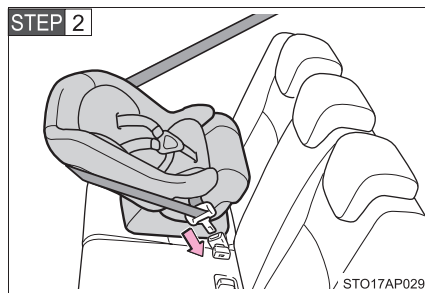

Run the seat belt through the child restraint system and insert the plate into the buckle. Make sure that the belt is not twisted.

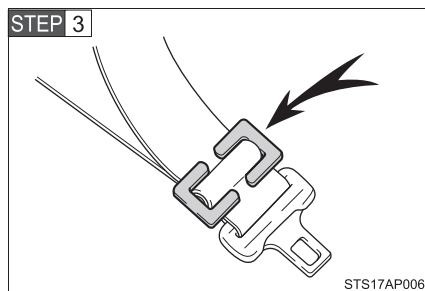

Install a locking clip near the tab of the lap and shoulder belt by inserting the lap and shoulder webbing through the recesses of the locking clip. Buckle the belt again. If the belt has any slack, release the buckle and reinstall the locking clip.

1

Before driving

■ **Forward facing — Child seat**

STEP 1 Remove the head restraint. (→P. 82)

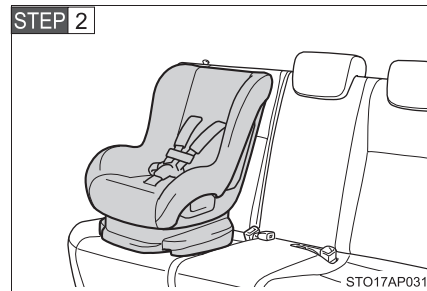

Place the child restraint system on the seat facing the front of the vehicle.

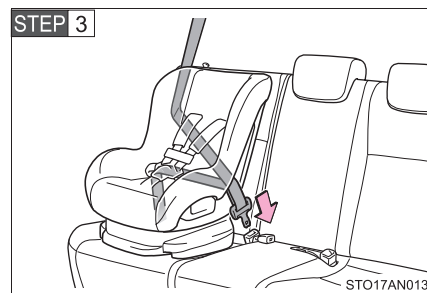

Run the seat belt through the child restraint system and insert the plate into the buckle. Make sure that the belt is not twisted.

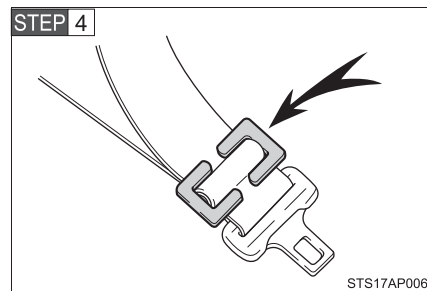

Install a locking clip near the tab of the lap and shoulder belt by inserting the lap and shoulder webbing through the recesses of the locking clip. Buckle the belt again. If the belt has any slack, release the buckle and reinstall the locking clip.

■ Junior seat

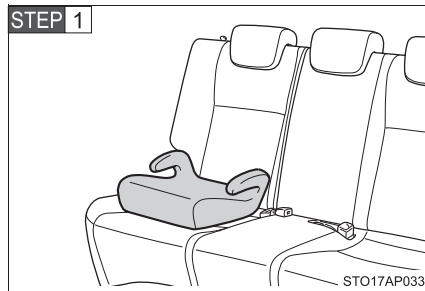

Place the child restraint system on the seat facing the front of the vehicle.

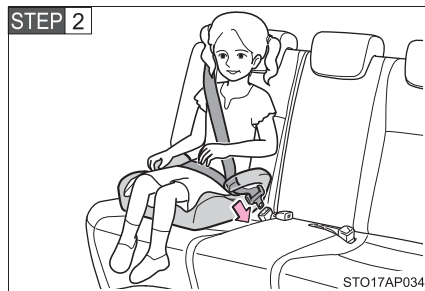

Sit the child in the child restraint system. Fit the seat belt to the child restraint system according to the manufacturer's instructions and insert the plate into the buckle. Make sure that the belt is not twisted.

Check that the shoulder belt is correctly positioned over the child's shoulder and that the lap belt is as low as possible.
(→P. 84)

1
Before driving

Removing a child restraint installed with a seat belt

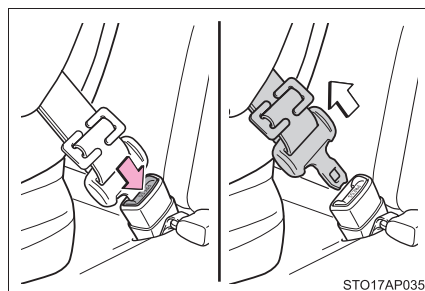

Push the buckle release button and fully retract the seat belt.

Installation with ISOFIX rigid anchors (ISOFIX child restraint system) (vehicles with rear seats)

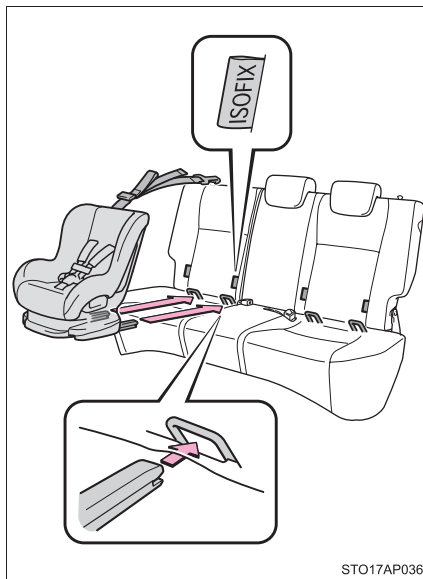

STEP 1 Widen the gap between the seat cushion and seatback slightly.

STEP 2 Latch the buckles onto the anchors.

If the child restraint has a top strap, the top strap should be latched onto the anchor bracket.

Child restraint systems with a top strap (vehicles with rear seats)

STEP 1 Vehicles with a luggage cover: Remove the luggage cover. (→P. 351)

STEP 2 Remove the head restraint. (→P. 82)

STEP 3 Secure the child restraint system using a seat belt or ISOFIX rigid anchors.

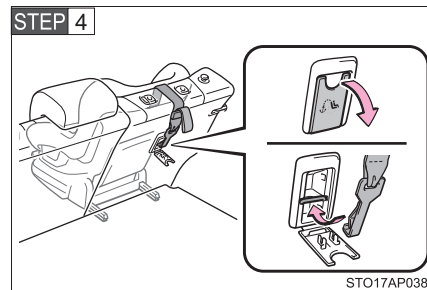

Open the anchor bracket cover, latch the hook onto the anchor bracket and tighten the top strap.

Make sure the top strap is securely latched.

STEP 5 Vehicles with a luggage cover: Reinstall the luggage cover.

■ **When installing a child restraint system using a seat belt**

You need a locking clip to install the child restraint system using a seat belt. Follow the instructions provided by the manufacturer of the system. If your child restraint system does not provide a locking clip, you can purchase the following item from any authorized Toyota dealer or repairer, or another duly qualified and equipped professional:

Locking clip for child restraint system
(Part No. 73119-22010)

1

Before driving

⚠ CAUTION

■ When installing a child restraint system

Follow the directions given in the child restraint system installation manual and fix the child restraint system securely in place.

If the child restraint system is not correctly fixed in place, the child or other passengers may be seriously injured or even killed in the event of sudden braking, sudden swerving or an accident.

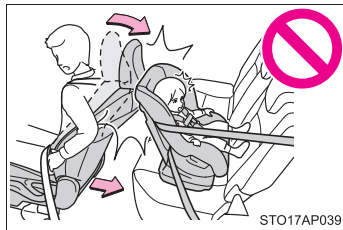

- If the driver's seat interferes with the child restraint system and prevents it from being attached correctly, attach the child restraint system to the right-hand rear seat (left-hand drive vehicles) or the left-hand rear seat (right-hand drive vehicles).

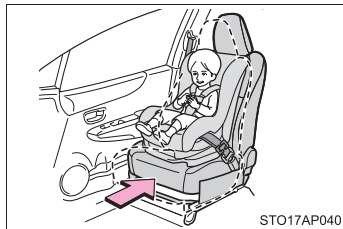

- Adjust the front passenger seat so that it does not interfere with the child restraint system.
- When installing a forward-facing child restraint system on the front passenger seat, move the seat as far back as possible. Failure to do so may result in death or serious injury if the airbags deploy (inflate).

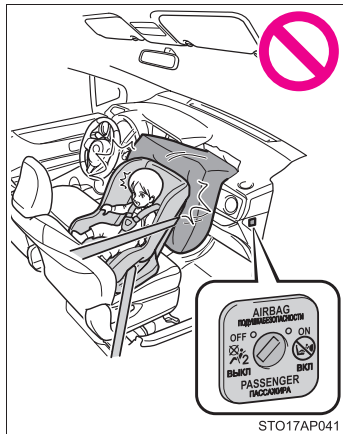
⚠ CAUTION**■ When installing a child restraint system**

- Never use a rear-facing child restraint system on the front passenger seat when the airbag manual on-off switch is on. (→P. 122)

The force of the rapid inflation of the front passenger airbag can cause death or serious injury to children in the event of an accident.

There is a label on both sides of the passenger side sun visor, indicating it is forbidden to attach a rear-facing child restraint system to the front passenger seat.

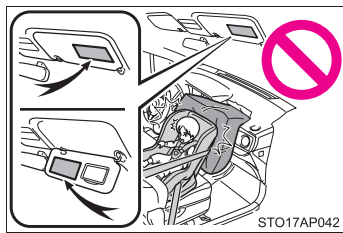

Details of the label on the passenger side sun visor are shown in the illustrations below. The label includes information written in the language of your country.

1



Before driving

 **CAUTION**
 **When installing a child restraint system**
Type A

 WARNING AVERTISSEMENT WARNING AVVISO ADVERTENCIA WAARSCHUWING	
	DO NOT place a rear facing child seat on the front seat unless the passenger airbag is deactivated. DEATH OR SERIOUS INJURY can occur. See owner's manual.
	NE JAMAIS placer un siège enfant positionné dos à la route sur le siège avant, sauf si l'airbag passager est désactivé. Risque de MORT OU BLESSURE GRAVE . Voir le manuel du propriétaire.
	KEINEN rückwärtsgerichteten Kindersitz auf dem Vordersitz verwenden, außer der Beifahrer-Airbag ist deaktiviert. TOD ODER SCHWERE VERLETZUNGEN können die Folge sein. Siehe Betriebsanleitung.
	NON posizionare il seggiolino per bambini rivolto in senso opposto a quello di marcia sul sedile anteriore se l'airbag del passeggero non è stato disattivato. Rischio di MORTE O LESIONI GRAVI . Consultare il manuale di uso e manutenzione.
	NO coloque una silla para niños en sentido contrario al de la marcha del vehículo en el asiento del acompañante, excepto si el airbag del pasajero estuviera desactivado. Riesgo de MUERTE O HERIDAS GRAVES . Consulte el manual del propietario.
	GEEN tegen de rijrichting in geplaatst kinderzitje op de voorstoel plaatsen, tenzij de passagiersairbag gedeactiveerd is. DOOD OF ZWARE VERWONDINGEN kunnen het gevolg zijn. Zie instructieboekje.

STS17AP001

Type B



 AVISO ΠΡΟΣΟΧΗ ΑΤΕΝΤΙΟΝΑΡΕ ВНИМАНИЕ УЯРИ ВНИМАНИЕ КУЈДЕС	
	NÃO instale uma cadeirinha para crianças voltada para trás no banco da frente sem desativar o airbag do passageiro. Risco de MORTE OU FERIMENTOS GRAVES . Consulte o manual do proprietário.
	ΜΗΝ τοποθετείτε παιδικό κάθισμα οπίσθιου προσανατολισμού στο μπροστινό κάθισμα, εκτός αν είναι απενεργοποιημένος ο αερόσακος συνοδηγού. Ενδέχεται να προκληθεί ΘΑΝΑΤΟΣ Ή ΣΟΒΑΡΟΣ ΤΡΑΥΜΑΤΙΣΜΟΣ . Συμβουλευτείτε το βιβλίο οδηγιών χρήσης.
	NU montați pe scaunul din față scaunul pentru copil orientat cu spatele la sensul de mers decât dacă airbag-ul pentru pasager este dezactivat. Nerespectarea acestei reguli poate provoca MOARTEA SAU RANIREA GRAVĂ A COPILULUI . Vezi manualul utilizatorului.
	НЕ поставяйте обърнато назад детско столче върху предната седалка, освен ако въздушната възглавница за пътника не е деактивирана. Неспазването на това условие може да доведе до СМЪРТ ИЛИ СЕРИОЗНО НАРАНЯВАНЕ . За повече информация вижте инструкцията за експлоатация.
	Yolcu hava yastığı devre dışı bırakılmıyışsa, yüzü geriye bakan çocuk güvenli koltuğunu ASLA ön koltuğa KOYMAYIN, ÖLÜME VEYA CİDDİ YARALANMALARA sebebiyet verebilir. Kullanıcı el kitabına bakınız.
	Детското седиште наменето за задниот ред ДА НЕ СЕ СТАВА на предно седиште, освен во случај ако не е исклучено совозачкото воздушно перниче. Може да дојде до СМРТ или СЕРИОЗНИ ПОВРЕДНИ Погледнете го корисничкото упатство.
MOS vendosni nje mbajtëse femije me fytyre nga sedilja e pare nese nuk e keni c'aktivizuar airbag-un e pasagjerit. MUND TE SHKAKTOJE VDEKJE OSE DENTIM TE RENDE . Shikoni manualin e perdormit.	

STS17AP002

 CAUTION



■ When installing a child restraint system

Type C

 Предупреждение OSTRZEŻENIE VÝSTRAHA VAROVANIE FIGYELMEZTETÉS УВАГА! ВПОВІДУН	
	<p>NE USTANAVLIVAJTE detskú kreslu na prednej sedadle v smere jazdy, protipoložnom pohybe vozidla, ak je poduška bezpečnosti pasážiara neotvorená. Výsledkom môžu byť ŤAŽKÉ TRAVMY ILI LETALNÝ ISCHOD. Pozrite si návod na obsluhu.</p>
	<p>NIGDY NIE wolno umieszczać na przednim siedzeniu samochodowego fotelika dziecięcego, mocowanego tyłem do kierunku jazdy, jeżeli nie została odłączona poduszka powietrzna pasażera. Może dojść do ŚMIERCI LUB POWAŻNEGO OBRAŻENIA CIAŁA. Patrz Instrukcja obsługi.</p>
	<p>NE UMÍSTUJTE dětskou sedačku směřující proti směru jízdy na přední sedadlo, pokud není airbag spolujezdce deaktivován. Mohlo by dojít k VÁŽNĚMU NEBO SMRTELNĚMU PORANĚNÍ. Viz uživatelská příručka.</p>
	<p>ZÁKAZ UMÍSTNENIA detskej sedačky na prednom sedadle proti smeru jazdy, pokiaľ nie je deaktivovaný airbag spolujazdca. Hrozí NEBEZPEČENSTVO SMRTI ALEBO VÁŽNEHO ZRANENIA. Pozri príručku užívateľa.</p>
	<p>TILOS az első utasülésre hátrafelé néző gyermekülést helyezni, amíg az utasoldali légszékot nem hatástalanították. HALÁLT VAGY SÚLYOS SÉRÜLÉST okozhat. További információkat a kezelési útmutatóban talál.</p>
	<p>ЗАБОРОНЯЄТЬСЯ встановлювати дитяче автокрісло на переднє сидіння проти руху, якщо увімкнута подушка безпеки пасажирів. Це може призвести до ВАЖКИХ ТРАВМ ЧИ НАВІТЬ ДО СМЕРТІ. Див. посібник користувача.</p>
<p>SETJØ EKKI bakvisandi barnabítlól í framsæti nema að öryggisþúði hafi verið aftengdur. Öryggisþúði sem lendir á barnabítlól getur orsakað ALVARLEGA AVERKA EÐA DAUÐA. Sjá eigandahandbók.</p>	

STS17AP003

Type D

 ĮSPĖJIMAS HOIATUS BRĪDINĀJUMS ADVARSEL VAROITUS VARNING ADVARSEL	
	<p>NETVIRTINKITE į galą atsuktos vaikiškos automobilinės kėdutės ant priekinės keleivio sėdynės jei neišjungta oro pagalvė - GALITE RIMTAI AR MIRTINAI sužaloti kėdutėje sėdintį vaiką. Žr. Instrukcija automobilio savininkui.</p>
	<p>ARGE asetage seljaga sõidusuunas olevat lapse turvatooli esiistmele, välja arvatud juhul, kui kaassõitja turvapadi on välja lülitatud. Tagajärjeks võib olla SURM VÕI TÕSINE VIGASTUS. Vaadake omaniku käsiraamatut.</p>
	<p>NENOVİETOJİET uz aizmuguri vērstu bērna sēdekļi uz priekšējā sēdekļa, izņemot, ja ir deaktivizēts pasažiera gaisa spilvens. Tas var izraisīt NĀVI VAI NOPIETNU SAVAINOJUMU. Skatiet lietotāja rokasgrāmatu.</p>
	<p>Placer ALDRIG et bagudvendt barnesæde på forsædet, uden at passagersædets airbag er frakoblet. Risiko for DØD ELLER ALVORLIG PERSONSKADE. Se instruktionsbog.</p>
	<p>ÄLÄ aseta etuistuimelle selkä menosuuntaan asennettavaa lasten turvaistuinta silloin, kun matkustajan turvatyynyä ei ole kytketty pois toiminnasta. Seurauksena voi olla KUOLEMA TAI VAKAVA LOUKKAANTUMINEN. Katso lisäohjeet omistajan käsikirjasta.</p>
	<p>DU FÅR ALDRIG placera en bakåtvänd barnstol i framsätet, om inte passagerar krockkudden är avaktiverad. DÖDSFALL ELLER ALLVARLIGA PERSONSKADOR kan inträffa. Se instruktionsbok.</p>
<p>IKKE plasser et bakovervendt barnesete i passasjerasetet foran med mindre kollisjonsputen er deaktivert. Dette kan medføre ALVORLIG PERSONSKADE. Se brukerhåndboken for mer informasjon.</p>	

STS17AP004

1

Before driving

⚠ CAUTION

■ When installing a child restraint system

Type E

⚠	אזהרה	UPOZORENJE	OPAZORILO	Upozorenje	UPOZORENJE	Upozorenje	KUJDES
	<p>אין לחבר מושב בטיחות לילד על המושב הקדמי עם הפנים לאחור, אלא אם פעולת כרית האוויר בצד הנוסע הושבתה. קיימת סכנת מוות או פציעה חמורה. עיין המדריך למשתמש.</p>	<p>Dječju sjedalicu namijenenu za stražnje sjedalo NE postavljajte na sjedalo suvozača osim ako ste isključili prednji zračni jastuk. U suprotnom može doći do POGIBIJE ILI TEŠKIH OZLJEDA. Proučite priručnik za korisnika.</p>	<p>NE NAMEŠČAJTE otroškega sedeža, v katerem sedi otrok s hrbtom obrnjen v smer vožnje, na sprednji sedež, če sovoznikova varnostna blazina ni izklopljena. Lahko bi prišlo do RESNE POŠKODBE ALI SMRTI. Prosimo, preberite navodila za uporabo.</p>	<p>Ne postavljajte dječije auto sedište koje gleda nazad na prednje sedište ukoliko vazdušni jastuk za suvozača nije isključen. U slučaju nesreće mogu nastupiti smrt ili ozbiljne povrede. Obavezno pročitajte uputstvo za upotrebu.</p>	<p>Dječju sjedalicu koja gleda prema nazad NE postavljajte na prednje sjedište ukoliko zračni jastuk suvozača nije isključen. Može doći do SMRTI ILI OZBILJNIH povreda. Pogledajte Upute za rukovanje.</p>	<p>Ne postavljajte dječije auto-sjedište koje gleda nazad na prednje sjedište ukoliko vazdušni jastuk za suvozača nije isključen. U slučaju nesreće mogu nastupiti smrt ili ozbiljne povrede. Obavezno pročitajte uputstvo za upotrebu.</p>	<p>MOS vendosni nje mbajtese femije me fytyre nga sedilja e pare nese nuk e keni c'aktivizuar airbag-un e pasagjerit. MUND TE SHKAKTOJE VDEKJE OSE DEMTIM TE RENDE. Shikoni manualin e perdorimit.</p>

STS17AP005

- If child restraint system regulations exist in the country where you reside, please contact any authorized Toyota dealer or repairer, or another duly qualified and equipped professional for the child restraint system installation.
- When a junior seat is installed, always ensure that the shoulder belt is positioned across the center of the child's shoulder. The belt should be kept away from the child's neck, but not so that it could fall off the child's shoulder. Failure to do so may result in death or serious injury in the event of sudden braking, sudden swerving or an accident.
- Ensure that the belt and plate are securely locked and the seat belt is not twisted.
- Push and pull the child restraint system from side to side and forward to be sure it is secure.
- After securing a child restraint system, never adjust the seat.

⚠ CAUTION**■ When installing a child restraint system**

- Follow all installation instructions provided by the child restraint system manufacturer.
- When a child restraint system with a top strap is installed, do not install the head restraint. The head restraint may interfere with the top strap preventing secure installation of the child restraint system.
- Make sure to properly store the removed head restraint in a secure place when you use the child restraint system on the rear seat.



- When using the right side seat for the child restraint system, do not sit in the center seat. Seat belt function may be impaired, such as being positioned overly high or loose-fitting, which may result in death or serious injury in the event of sudden braking or an accident.

■ To correctly attach a child restraint system to the anchors

When using the lower anchors, be sure that there are no foreign objects around the anchors and that the seat belt is not caught behind the child restraint system. Make sure the child restraint system is securely attached, or it may cause death or serious injury to the child or other passengers in the event of sudden braking, sudden swerve or an accident.

1-7. Safety information

When driving

2

2-1. Driving procedures

Driving the vehicle	148
Engine (ignition) switch (vehicles without a smart entry & start system).....	165
Engine (ignition) switch (vehicles with a smart entry & start system).....	169
Multidrive	179
Multi-mode manual transmission	185
Manual transmission.....	190
Turn signal lever	194
Parking brake	195
Horn.....	196

2-2. Instrument cluster

Gauges and meters	197
Indicators and warning lights	201
Multi-information display ...	208

2-3. Operating the lights and wipers

Headlight switch.....	214
Fog light switch	220
Windshield wiper and washer	222
Rear window wiper and washer	226

2-4. Using other driving systems

Cruise control.....	228
Speed limiter	232
Stop & Start system	235
Driving assist systems	243
Diesel particulate filter system	248

2-5. Driving information

Cargo and luggage	250
Winter driving tips	252
Trailer towing (except for South Africa).....	256

2-1. Driving procedures

Driving the vehicle

The following procedures should be observed to ensure safe driving:

■ Starting the engine

→P. 165, 169

■ Driving

Vehicles with a Multidrive

STEP 1 With the brake pedal depressed, shift the shift lever to D.
(→P. 179)

STEP 2 Release the parking brake. (→P. 195)

STEP 3 Gradually release the brake pedal and gently depress the accelerator pedal to accelerate the vehicle.

Vehicles with a multi-mode manual transmission

STEP 1 With the brake pedal depressed, shift the shift lever to E or M. (→P. 185)

When shifting the shift lever to E: Make sure that the display of the gear position indicator shows E.

When shifting the shift lever to M: Make sure that the display of the gear position indicator shows 1.

STEP 2 Release the parking brake. (→P. 195)

STEP 3 Gradually release the brake pedal and gently depress the accelerator pedal to accelerate the vehicle.

Vehicles with a manual transmission

STEP 1 While depressing the clutch pedal, shift the shift lever to 1.
(→P. 190)

STEP 2 Release the parking brake. (→P. 195)

STEP 3 Gradually release the clutch pedal. At the same time, gently depress the accelerator pedal to accelerate the vehicle.

■ Stopping

Vehicles with a Multidrive

STEP 1 With the shift lever in D, depress the brake pedal.

Vehicles with a Stop & Start system: If the Stop & Start system is enabled, depressing the brake pedal will stop the engine. (→P. 235)

STEP 2 If necessary, set the parking brake.

If the vehicle is to be stopped for an extended period of time, shift the shift lever to P or N. (→P. 179)

Vehicles with a multi-mode manual transmission

STEP 1 With the shift lever in E or M, depress the brake pedal.

STEP 2 If necessary, set the parking brake.

If the vehicle is to be stopped for an extended period of time, shift the shift lever to N. (→P. 185)

Vehicles with a manual transmission

STEP 1 While depressing the clutch pedal, depress the brake pedal.

STEP 2 If necessary, set the parking brake.

If the vehicle is to be stopped for an extended period of time, shift the shift lever to N. (→P. 190)

Vehicles with a Stop & Start system: If the Stop & Start system is enabled, shifting the shift lever to N and releasing the clutch pedal will stop the engine. (→P. 235)

■ Parking the vehicle

Vehicles with a Multidrive

STEP 1 With the shift lever in D, depress the brake pedal.

STEP 2 Set the parking brake. (→P. 195)

STEP 3 Shift the shift lever to P. (→P. 179)

If parking on a hill, block the wheels as needed.

STEP 4 Vehicles without a smart entry & start system:

Turn the engine switch to the “LOCK” position to stop the engine.

Vehicles with a smart entry & start system:

Press the “ENGINE START STOP” switch to stop the engine.

STEP 5 Lock the door, making sure that you have the key on your person.

Vehicles with a multi-mode manual transmission

STEP 1 With the shift lever in E or M, depress the brake pedal.

STEP 2 Set the parking brake. (→P. 195)

STEP 3 Shift the shift lever to E, M or R. (→P. 185)

If parking on a hill, block the wheels as needed.

STEP 4 Vehicles without a smart entry & start system: Turn the engine switch to the “LOCK” position to stop the engine.

Vehicles with a smart entry & start system: Press the “ENGINE START STOP” switch to stop the engine.

Make sure that the display of the gear position indicator shows 1 or R.

STEP 5 Lock the door, making sure that you have the key on your person.

Vehicles with a manual transmission

- STEP 1** While depressing the clutch pedal, depress the brake pedal.
- STEP 2** Set the parking brake. (→P. 195)
- STEP 3** Shift the shift lever to N. (→P. 190)
If parking on a hill, shift the shift lever to 1 or R and block the wheels as needed.
- STEP 4** Vehicles without a smart entry & start system: Turn the engine switch to the “LOCK” position to stop the engine.
Vehicles with a smart entry & start system: Press the “ENGINE START STOP” switch to stop the engine.
- STEP 5** Lock the door, making sure that you have the key on your person.

2

When driving

Starting off on a steep uphill

Vehicles with a Multidrive

STEP 1 Make sure that the parking brake is set and shift the shift lever to D.

STEP 2 Gently depress the accelerator pedal.

STEP 3 Release the parking brake.

Vehicles with a multi-mode manual transmission

STEP 1 With the brake pedal depressed, firmly set the parking brake and shift the shift lever to E or M.

When shifting the shift lever to E: Make sure that the display of the gear position indicator shows E.

When shifting the shift lever to M: Make sure that the display of the gear position indicator shows 1.

STEP 2 Gently depress the accelerator pedal.

STEP 3 Release the parking brake.

Vehicles with a manual transmission

STEP 1 With the parking brake firmly set and the clutch pedal fully depressed, shift the shift lever to 1.

STEP 2 Lightly depress the accelerator pedal at the same time as gradually releasing the clutch pedal.

STEP 3 Release the parking brake.

■ Driving in the rain

- Drive carefully when it is raining, because visibility will be reduced, the windows may become fogged-up, and the road will be slippery.
- Drive carefully when it starts to rain, because the road surface will be especially slippery.
- Refrain from high speeds when driving on an expressway in the rain, because there may be a layer of water between the tires and the road surface, preventing the steering and brakes from operating properly.

■ Breaking in your new Toyota

To extend the life of the vehicle, observing the following precautions is recommended:

- For the first 300 km (186 miles):
Avoid sudden stops.
- For the first 800 km (500 miles):
Do not tow a trailer.
- For the first 1000 km (621 miles):
 - Do not drive at extremely high speeds.
 - Avoid sudden acceleration.
 - Do not drive continuously in low gears.
 - Do not drive at a constant speed for extended periods.

■ Idling time before stopping the engine (diesel engine)

To prevent damage to the turbocharger, allow the engine to idle immediately after high-speed driving or driving up a hill.

Driving condition		Idling time
Normal city driving		Not necessary
High-speed driving	Constant speed of approx. 80 km/h (50 mph)	Approximately 20 seconds
	Constant speed of approx. 100 km/h (63 mph)	Approximately 1 minute
Steep hill driving or continuous driving at 100 km/h (63 mph) or more (race track driving etc.)		Approximately 2 minutes

■ **Eco-friendly driving (vehicles with a Multidrive)**

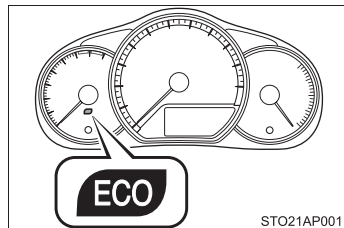

During Eco-friendly acceleration operation (Eco driving), Eco Driving Indicator Light will turn on. When the accelerator pedal is depressed excessively, and when the vehicle is stopped, the light turns off.

Eco Driving Indicator Light will not operate in any of the following conditions:

- The shift position is anything other than D.
- The driving mode is set to sport mode.
- The paddle shift switch is operated while the shift position is D.
- The vehicle speed is approximately 130 km/h (80 mph) or higher.

Eco Driving Indicator Light can be activated or deactivated. (→P. 213)

■ **Operating your vehicle in a foreign country**

Comply with the relevant vehicle registration laws and confirm the availability of the correct fuel. (→P. 523)

⚠ CAUTION**■ When starting the vehicle**

On vehicles with a Multidrive, always keep your foot on the brake pedal while stopped with the engine running. This prevents the vehicle from creeping.

On vehicles with a multi-mode manual transmission, always keep your foot on the brake pedal while stopped with the engine running. This prevents the vehicle from moving unexpectedly.

■ When driving the vehicle

- Do not drive if you are unfamiliar with the location of the brake and accelerator pedals to avoid depressing the wrong pedal.
 - Accidentally depressing the accelerator pedal instead of the brake pedal will result in sudden acceleration that may lead to an accident that could result in death or serious injury.
 - When backing up, you may twist your body around, leading to a difficulty in operating the pedals. Make sure to operate the pedals properly.
 - Make sure to keep a correct driving posture even when moving the vehicle only slightly. This allows you to depress the brake and accelerator pedals properly.
 - Depress the brake pedal using your right foot. Depressing the brake pedal using your left foot may delay response in an emergency, resulting in an accident.
- Do not drive the vehicle over or stop the vehicle near flammable materials. The exhaust system and exhaust gases can be extremely hot. These hot parts may cause a fire if there is any flammable material nearby.
- On vehicles with a Multidrive or a multi-mode manual transmission, do not let the vehicle roll backward while the shift lever is in a driving position, or roll forward while the shift lever is in R. Doing so may cause the engine to stall or lead to poor brake and steering performance, resulting in an accident or damage to the vehicle.
- If the smell of exhaust is noticed inside the vehicle, open the windows and check that the back door is closed. Large amounts of exhaust in the vehicle can cause driver drowsiness and an accident, resulting in death or a serious health hazard. Have the vehicle inspected immediately by any authorized Toyota dealer or repairer, or another duly qualified and equipped professional immediately.

 CAUTION

- On vehicles with a Mutidrive, do not under any circumstances shift the shift lever to P while the vehicle is moving.
Doing so can cause significant damage to the driveline and may result in a loss of vehicle control.
- On vehicles with a Multidrive, do not shift the shift lever to P while the vehicle is moving.
Doing so can damage the transmission and may result in a loss of vehicle control.
- Do not shift the shift lever to R while the vehicle is moving forward.
Doing so can damage the transmission and may result in a loss of vehicle control.
- Do not shift the shift lever to D (vehicles with a Multidrive), E (vehicles with a multi-mode manual transmission) or 1 (vehicles with a manual transmission) while the vehicle is moving backward.
Doing so can damage the transmission and may result in a loss of vehicle control.
- Moving the shift lever to N while the vehicle is moving will disengage the engine from the transmission. Engine braking is not available when N is selected.
- During normal driving, do not turn off the engine. Turning the engine off while driving will not cause loss of steering or braking control, but the power assist to these systems will be lost. This will make it more difficult to steer and brake, so you should pull over and stop the vehicle as soon as it is safe to do so.
However, in the event of an emergency, such as if it becomes impossible to stop the vehicle in the normal way: →P. 514
- Use engine braking (downshift) to maintain a safe speed when driving down a steep hill.
Using the brakes continuously may cause the brakes to overheat and lose effectiveness. (→P. 180, 185)
- When stopped on an inclined surface, use the brake pedal and parking brake to prevent the vehicle from rolling backward or forward and causing an accident.

⚠ CAUTION

- Do not adjust the positions of the steering wheel, the seat, or the inside or outside rear view mirrors while driving.
Doing so may result in a loss of vehicle control that can cause accidents, resulting in death or serious injury.

- Always check that all passengers' arms, heads or other parts of their body are not outside the vehicle, as this may result in death or serious injury.

■ When driving on slippery road surfaces

- Sudden braking, acceleration and steering may cause tire slippage and reduce your ability to control the vehicle, resulting in an accident.
- Sudden changes in engine speed, such as engine braking caused by up-shifting and down-shifting, may cause the vehicle to skid, resulting in an accident.
- After driving through a puddle, lightly depress the brake pedal to make sure that the brakes are functioning properly. Wet brake pads may prevent the brakes from functioning properly. If the brakes on only one side are wet and not functioning properly, steering control may be affected, resulting in an accident.

■ When shifting the shift lever (vehicles with a Multidrive or a multi-mode manual transmission)

Be careful not to shift the shift lever with the accelerator pedal depressed. Shifting the shift lever to a gear other than P (vehicles with a Multidrive only) or N may lead to unexpected rapid acceleration of the vehicle that may cause an accident and result in death or serious injury.

■ If you hear a squealing or scraping noise (brake pad wear indicators)

Have the brake pads checked and replaced by any authorized Toyota dealer or repairer, or another duly qualified and equipped professional as soon as possible.

Rotor damage may result if the pads are not replaced when needed.

It is dangerous to drive the vehicle when the wear limits of the brake pads and/or those of the brake discs are exceeded.

 CAUTION

■ **When the vehicle is stopped**

- Do not race the engine.
If the vehicle is in any gear other than P (vehicles with a Multidrive only) or N, the vehicle may accelerate suddenly and unexpectedly, causing an accident.
- Do not leave the vehicle with the engine running for a long time.
If such a situation cannot be avoided, park the vehicle in an open space and check that exhaust fumes do not enter the vehicle interior.
- On vehicles with a Multidrive or a multi-mode manual transmission, in order to prevent accidents due to the vehicle rolling away, always keep depressing the brake pedal while the engine is running, and apply the parking brake as necessary.
- If the vehicle is stopped on an incline, in order to prevent accidents caused by the vehicle rolling forward or backward, always depress the brake pedal and securely apply the parking brake as needed.
- Avoid revving or racing the engine.
Running the engine at high speed while the vehicle is stopped may cause the exhaust system to overheat, which could result in a fire if combustible material is nearby.

■ **When the vehicle is parked**

- Do not leave glasses, cigarette lighters, spray cans, or soft drink cans in the vehicle when it is in the sun.
Doing so may result in the following:
 - Gas may leak from a cigarette lighter or spray can, and may lead to a fire.
 - The temperature inside the vehicle may cause the plastic lenses and plastic material of glasses to deform or crack.
 - Soft drink cans may fracture, causing the contents to spray over the interior of the vehicle, and may also cause a short circuit in the vehicle's electrical components.
- Do not leave cigarette lighters in the vehicle. If a cigarette lighter is in a place such as the glove box or on the floor, it may be lit accidentally when luggage is loaded or the seat is adjusted, causing a fire.

⚠ CAUTION

- Do not attach adhesive discs to the windshield or windows. Do not place containers such as air fresheners on the instrument panel or dashboard. Adhesive discs or containers may act as lenses, causing a fire in the vehicle.
- Do not leave a door or window open if the curved glass is coated with a metallized film such as a silver-colored one. Reflected sunlight may cause the glass to act as a lens, causing a fire.
- On vehicles with a Multidrive, always apply the parking brake, shift the shift lever to P, stop the engine and lock the vehicle.
Do not leave the vehicle unattended while the engine is running.
- On vehicles with a multi-mode manual transmission, always apply the parking brake, shift the shift lever to E, M or R, stop the engine and lock the vehicle.
Do not leave the vehicle unattended while the engine is running.
- Do not touch the exhaust pipes while the engine is running or immediately after turning the engine off.
Doing so may cause burns.
- Do not leave the engine running in an area with snow build-up, or where it is snowing. If snowbanks build up around the vehicle while the engine is running, exhaust gases may collect and enter the vehicle. This may lead to death or a serious health hazard.
- On vehicles with a multi-mode manual transmission, do not turn off the engine until 1st or reverse is engaged properly and completely. Confirm that the gear is engaged by viewing the gear position indicator.
Parking the vehicle without a gear engaged may cause the vehicle to move result in an accident.

 CAUTION

■ **Exhaust gases**

Exhaust gases include harmful carbon monoxide (CO), which is colorless and odorless. Inhaling exhaust gases may lead to death or a serious health hazard.

- If the vehicle is in a poorly ventilated area, stop the engine. In a closed area, such as a garage, exhaust gases may collect and enter the vehicle. This may lead to death or a serious health hazard.
- The exhaust system should be checked occasionally. If there is a hole or crack caused by corrosion, damage to a joint or abnormal exhaust noise, be sure to have the vehicle inspected and repaired by any authorized Toyota dealer or repairer, or another duly qualified and equipped professional. Failure to do so may allow exhaust gases to enter the vehicle, resulting in death or a serious health hazard.

■ **When taking a nap in the vehicle**

Always turn the engine off. Otherwise, if you accidentally move the shift lever or depress the accelerator pedal, this could cause an accident or fire due to engine overheating. Additionally, if the vehicle is parked in a poorly ventilated area, exhaust gases may collect and enter the vehicle, leading to death or a serious health hazard.

 CAUTION■ **When braking**

- When the brakes are wet, drive more cautiously.
Braking distance increases when the brakes are wet, and this may cause one side of the vehicle to brake differently than the other side. Also, the parking brake may not securely hold the vehicle.
- If the power brake assist function does not operate, do not follow other vehicles closely and avoid hills or sharp turns that require braking.
In this case, braking is still possible, but the brake pedal should be depressed more firmly than usual. Also, the braking distance will increase.
- Do not pump the brake pedal if the engine stalls.
Each push on the brake pedal uses up the reserve for the power-assisted brakes.
- The brake system consists of 2 individual hydraulic systems; if one of the systems fails, the other will still operate. In this case, the brake pedal should be depressed more firmly than usual and the braking distance will increase.
If this happens, do not continue to drive the vehicle. Have your brakes fixed immediately.

 NOTICE

■ **When driving the vehicle**

Vehicles with a Multidrive

- Do not depress the accelerator and brake pedals at the same time during driving. If the brake pedal is depressed while driving with the accelerator pedal depressed, driving torque may be restrained.
- Do not use the accelerator pedal or depress the accelerator and brake pedals at the same time to hold the vehicle on a hill.

Vehicles with a multi-mode manual transmission

- Do not depress the accelerator and brake pedals at the same time during driving. If the brake pedal is depressed while driving with the accelerator pedal depressed, driving torque may be restrained.
- Do not use the accelerator pedal or starting assist system to hold the vehicle on a hill.
Doing so may damage the clutch.

Vehicles with a manual transmission

- Do not depress the accelerator and brake pedals at the same time during driving. If the brake pedal is depressed while driving with the accelerator pedal depressed, driving torque may be restrained.
- Do not shift gears unless the clutch pedal is fully depressed. After shifting, do not release the clutch pedal abruptly. Doing so may damage the clutch, transmission and gears.
- Observe the following to prevent the clutch from being damaged.
 - Do not rest your foot on the clutch pedal while driving.
Doing so may cause clutch trouble.
 - Do not use any gears other than the 1st gear when starting off and moving forward.
Doing so may damage the clutch.
 - Do not use the clutch to hold the vehicle when stopping on an uphill grade.
Doing so may damage the clutch.
- Do not shift the shift lever to R when the vehicle is still moving. Doing so may damage the clutch, transmission and gears.

 NOTICE

■ **When parking the vehicle (vehicles with a Multidrive)**

Always shift the shift lever to P. Failure to do so may cause the vehicle to move or the vehicle may accelerate suddenly if the accelerator pedal is accidentally depressed.

■ **Avoiding damage to vehicle parts**

- Do not turn the steering wheel fully in either direction and hold it there for an extended period of time.
Doing so may damage the power steering motor.
- When driving over bumps in the road, drive as slowly as possible to avoid damaging the wheels, underside of the vehicle, etc.
- Diesel engine only: Make sure to idle the engine immediately after high-speed driving or hill climbing. Stop the engine only after the turbocharger has cooled down.
Failure to do so may cause damage to the turbocharger.

■ **If you get a flat tire while driving**

A flat or damaged tire may cause the following situations. Hold the steering wheel firmly and gradually depress the brake pedal to slow down the vehicle.

- It may be difficult to control your vehicle.
- The vehicle will make abnormal sounds or vibrations.
- The vehicle will lean abnormally.

Information on what to do in case of a flat tire (→P. 459, 471)

 NOTICE

■ **When encountering flooded roads**

Do not drive on a road that has flooded after heavy rain etc. Doing so may cause the following serious damage to the vehicle:

- Engine stalling
- Short in electrical components
- Engine damage caused by water immersion

In the event that you drive on a flooded road and the vehicle is flooded, be sure to have any authorized Toyota dealer or repairer, or another duly qualified and equipped professional check the following:

- Brake function
- Changes in quantity and quality of engine oil, transmission fluid, etc.
- Lubricant condition for the bearings and suspension joints (where possible), and the function of all joints, bearings, etc.

2-1. Driving procedures



Engine (ignition) switch (vehicles without a smart entry & start system)

■ Starting the engine

Vehicles with a Multidrive

- STEP 1** Check that the parking brake is set.
- STEP 2** Check that the shift lever is set in P.
- STEP 3** Firmly depress the brake pedal.
- STEP 4** Turn the engine switch to the “START” position to start the engine.

Vehicles with a multi-mode manual transmission

- STEP 1** Check that the parking brake is set.
- STEP 2** Firmly depress the brake pedal, shift the shift lever to N. (→P. 185)
- STEP 3** Turn the engine switch to “ON” position.
The  indicator turns on.
- STEP 4** After the  indicator light goes out, turn the engine switch to the “START” position to start the engine.

Vehicles with a manual transmission (gasoline engine)

- STEP 1** Check that the parking brake is set.
- STEP 2** Check that the shift lever is set in N.
- STEP 3** Firmly depress the clutch pedal.
- STEP 4** Turn the engine switch to the “START” position to start the engine.

2

When driving

Vehicles with a manual transmission (diesel engine)

STEP 1 Check that the parking brake is set.

STEP 2 Check that the shift lever is set in N.

STEP 3 Firmly depress the clutch pedal.

STEP 4 Turn the engine switch to the "ON" position.

The  indicator turns on.

STEP 5 After the  indicator light goes out, turn the engine switch to the "START" position to start the engine.

■ Changing the engine switch positions

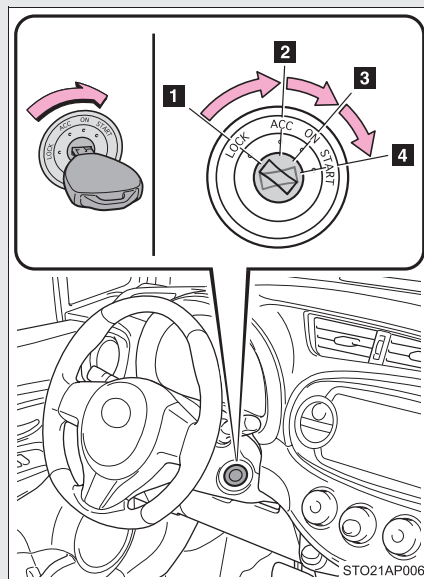

1 "LOCK"

The steering wheel is locked and the key can be removed. (Vehicles with a Multidrive: The key can be removed only when the shift lever is in P.)

2 "ACC"

Some electrical components such as the audio system can be used.

3 "ON"

All electrical components can be used.

4 "START"

For starting the engine.

■ Turning the key from “ACC” to “LOCK”

- STEP 1** Shift the shift lever to P (vehicles with a Multidrive) or E, M or R (vehicles with a multi-mode manual transmission).
(→P. 179, 185)

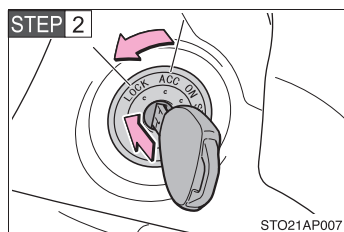

Push in the key and turn it to the “LOCK” position.

■ If the engine does not start

The engine immobilizer system may not have been deactivated. (→P. 104)

■ When the steering lock cannot be released

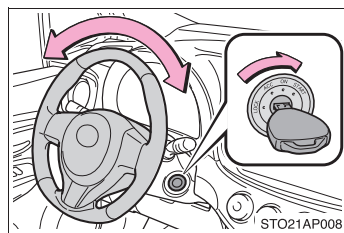

When starting the engine, the engine switch may seem stuck in the “LOCK” position. To free it, turn the key while turning the steering wheel slightly left and right.

■ Key reminder function

A buzzer sounds if the driver’s door is opened while the engine switch is in the “ACC” or “LOCK” position to remind you to remove the key.

 CAUTION

■ **When starting the engine**

Always start the engine while sitting in the driver's seat. Do not depress the accelerator pedal while starting the engine under any circumstances. Doing so may cause an accident resulting in death or serious injury.

■ **Caution when driving**

Do not turn the engine switch to the "LOCK" position while driving. If, in an emergency, you must turn the engine off while the vehicle is moving, turn the engine switch only to the "ACC" position to stop the engine. An accident may result if the engine is stopped while driving.

 NOTICE

■ **To prevent battery discharge**

Do not leave the engine switch in the "ACC" or "ON" position for long periods of time without the engine running.

■ **When starting the engine**

- Do not crank the engine for more than 30 seconds at a time. This may overheat the starter and wiring system.
- Do not race a cold engine.
- If the engine becomes difficult to start or stalls frequently, have the engine checked immediately.

2-1. Driving procedures

Engine (ignition) switch (vehicles with a smart entry & start system)

Performing the following operations when carrying the electronic key on your person starts the engine or changes “ENGINE START STOP” switch modes.

■ Starting the engine

Vehicles with a Multidrive

STEP 1 Check that the parking brake is set.

STEP 2 Check that the shift lever is set in P.

If the shift lever is not set in P, the engine may not be started.
(→P. 179)

STEP 3 Firmly depress the brake pedal.

The smart entry & start system indicator light (green) will turn on.
If the indicator light does not turn on, the engine cannot be started.

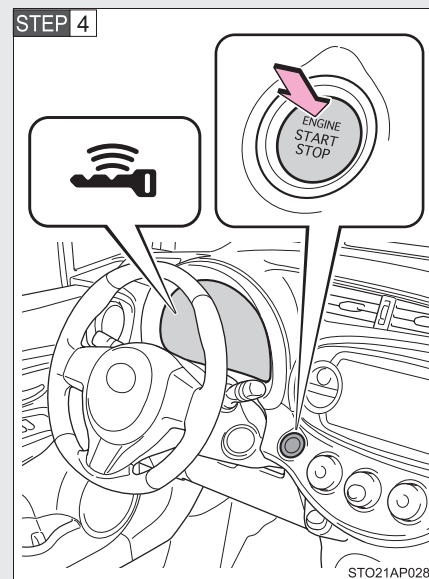

Press the “ENGINE START STOP” switch.

The engine will crank until it starts or for up to 30 seconds, whichever is less.

Continue depressing the brake pedal until the engine is completely started.

The engine can be started from any “ENGINE START STOP” switch mode.

Vehicles with a multi-mode manual transmission

STEP 1 Check that the parking brake is set.

STEP 2 Firmly depress the brake pedal, press the “ENGINE START STOP” switch once and shift the shift lever to N. (→P. 185)

The smart entry & start system indicator light (green) will turn on. If the indicator light does not turn on, the engine cannot be started.

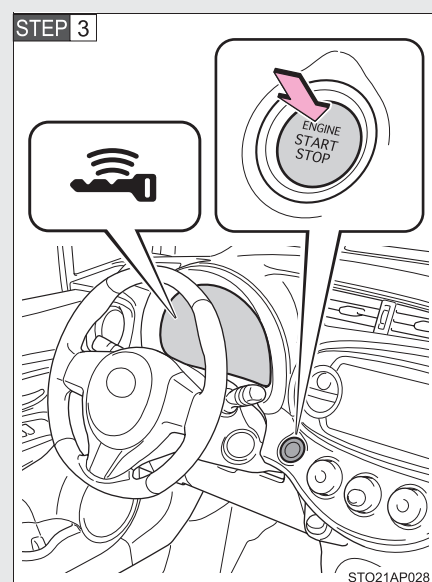

Press the “ENGINE START STOP” switch.

The engine will crank until it starts or for up to 30 seconds, whichever is less.

Continue depressing the brake pedal until the engine is completely started.

The  indicator turns on. The engine will start after the indicator light goes out.

The engine can be started from any “ENGINE START STOP” switch mode.

Vehicles with a manual transmission

STEP 1 Check that the parking brake is set.

STEP 2 Check that the shift lever is set in N.

STEP 3 Firmly depress the clutch pedal.

The smart entry & start system indicator light (green) will turn on. If the indicator light does not turn on, the engine cannot be started.

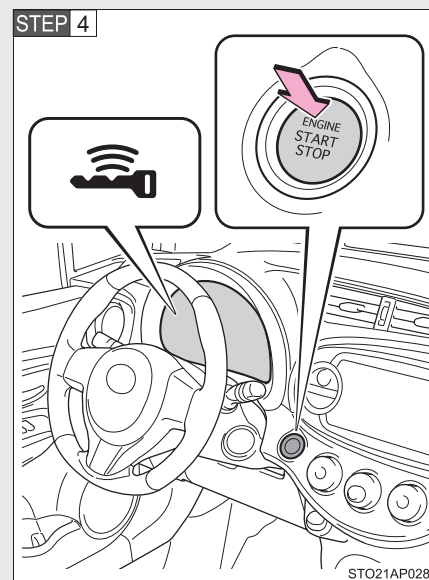

Press the “ENGINE START STOP” switch.

The engine will crank until it starts or for up to 30 seconds, whichever is less.

Continue depressing the clutch pedal until the engine is completely started.

Diesel engine only: The  indicator turns on. The engine will start after the indicator light goes out.

The engine can be started from any “ENGINE START STOP” switch mode.

■ Stopping the engine

Vehicles with a Multidrive

- STEP 1** Stop the vehicle.
- STEP 2** Shift the shift lever to P.
- STEP 3** Set the parking brake. (→P. 195)
- STEP 4** Release the brake pedal.
- STEP 5** Press the “ENGINE START STOP” switch.
- STEP 6** Check that the smart entry & start system indicator light (green) is off.

Vehicle with a multi-mode manual transmission

- STEP 1** Stop the vehicle.
- STEP 2** Shift the shift lever to E, M or R.
- STEP 3** Set the parking brake. (→P. 195)
- STEP 4** Release the brake pedal.
- STEP 5** Press the “ENGINE START STOP” switch.
- STEP 6** Check that the smart entry & start system indicator light (green) is off.

Vehicle with a manual transmission

- STEP 1** While depressing the clutch pedal, stop the vehicle.
- STEP 2** Shift the shift lever to N.
- STEP 3** Set the parking brake. (→P. 195)
- STEP 4** Release the clutch pedal.
- STEP 5** Press the “ENGINE START STOP” switch.
- STEP 6** Check that the smart entry & start system indicator light (green) is off.

■ Changing “ENGINE START STOP” switch mode

Modes can be changed by pressing the “ENGINE START STOP” switch with the brake pedal (except vehicles with a manual transmission) or clutch pedal (vehicles with a manual transmission) released. (The mode changes each time the switch is pressed.)

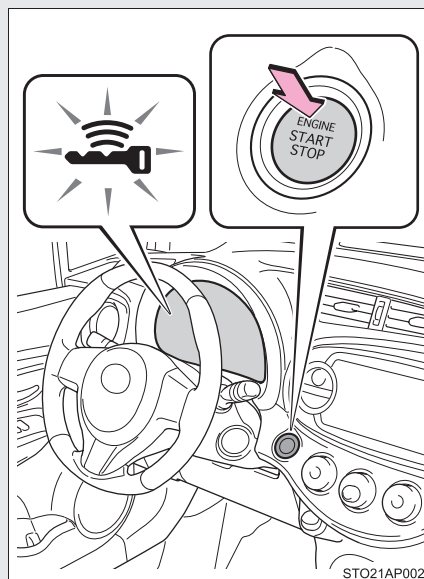

Off*

The emergency flashers can be used.

The smart entry & start system indicator light (green) is off.

ACCESSORY mode

Some electrical components such as the audio system can be used.

The smart entry & start system indicator light (green) flashes slowly.

IGNITION ON mode

All electrical components can be used.

The smart entry & start system indicator light (green) flashes slowly.

*: Vehicles with a Multidrive: If the shift lever is in a position other than P when turning off the engine, the “ENGINE START STOP” switch will be turned to ACCESSORY mode, not to off.

When stopping the engine with the shift lever in a position other than P (vehicles with a Multidrive)

If the engine is stopped with the shift lever in a position other than P, the “ENGINE START STOP” switch will not be turned off but instead be turned to ACCESSORY mode. Perform the following procedure to turn the switch off:

STEP 1 Check that the parking brake is set.

STEP 2 Shift the shift lever to P.

STEP 3 Check that the smart entry & start system indicator light (green) flashes slowly and then press the “ENGINE START STOP” switch once.

STEP 4 Check that the smart entry & start system indicator light (green) is off.

■ **Auto power off function**

Vehicles with a Multidrive

If the vehicle is left in ACCESSORY or IGNITION ON mode (the engine is not running) for more than an hour with the shift lever in P, the “ENGINE START STOP” switch will automatically turn off. However, this function cannot entirely prevent battery discharge. Do not leave the vehicle with the “ENGINE START STOP” switch in ACCESSORY or IGNITION ON mode for long periods of time when the engine is not running.

Vehicle with a multi-mode manual transmission and manual transmission

If the vehicle is left in ACCESSORY or IGNITION ON mode (the engine is not running) for more than an hour, the “ENGINE START STOP” switch will automatically turn off. However, this function cannot entirely prevent battery discharge. Do not leave the vehicle with the “ENGINE START STOP” switch in ACCESSORY or IGNITION ON mode for long periods of time when the engine is not running.

■ **Electronic key battery depletion**

→P. 55

■ **Conditions affecting operation**

→P. 52

■ **Notes for the entry function**

→P. 53

■ **If the engine does not start**

The engine immobilizer system may not have been deactivated. (→P. 104)

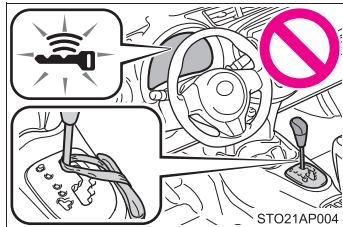

Vehicles with a Multidrive: Check that the shift lever is securely set in P. The engine may not start if the shift lever is displaced out of P. The smart entry & start system indicator light (green) will flash quickly.

■ **Steering lock**

After turning the “ENGINE START STOP” switch off and opening and closing the doors, the steering wheel will be locked due to the steering lock function. Operating the “ENGINE START STOP” switch again automatically cancels the steering lock.

■ **When the steering lock cannot be released**

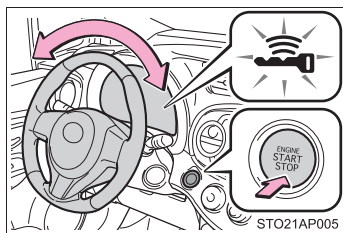

The smart entry & start system indicator light (green) will flash quickly.

Vehicles with a Multidrive

Check that the shift lever is set in P. Press the “ENGINE START STOP” switch while turning the steering wheel left and right.

Vehicles with a multi-mode manual transmission and manual transmission

Press the “ENGINE START STOP” switch while turning the steering wheel left and right.

■ **Steering lock motor overheating prevention**

To prevent the steering lock motor from overheating, the motor may be suspended if the engine is turned on and off repeatedly in a short period of time. In this case, refrain from operating the engine. After about 10 seconds, the steering lock motor will resume functioning.

■ **When the smart entry & start system indicator light flashes in yellow**

The system may be malfunctioning. Have the vehicle inspected by any authorized Toyota dealer or repairer, or another duly qualified and equipped professional immediately.

■ **If the electronic key battery is depleted**

→P. 401

■ **Operation of the “ENGINE START STOP” switch**

When operating the “ENGINE START STOP” switch, one short, firm press is enough. If the switch is pressed improperly, the engine may not start or the “ENGINE START STOP” switch mode may not change. It is not necessary to press and hold the switch.

■ **If the smart entry & start system has been deactivated in a customized setting**

→P. 542

 CAUTION**■ When starting the engine**

Always start the engine while sitting in the driver's seat. Do not depress the accelerator pedal while starting the engine under any circumstances. Doing so may cause an accident resulting in death or serious injury.

■ Caution while driving

If engine failure occurs while the vehicle is moving, do not lock or open the doors until the vehicle reaches a safe and complete stop. Activation of the steering lock in this circumstance may lead to an accident, resulting in death or serious injury.

■ Stopping the engine in an emergency

If you want to stop the engine in an emergency while driving the vehicle, push and hold the "ENGINE START STOP" switch for more than 3 seconds or press it briefly for 3 times or more in succession.

However, do not touch the "ENGINE START STOP" switch while driving except in an emergency. Turning the engine off while driving will not cause loss of steering or braking control, but the power assist to these systems will be lost. This will make it more difficult to steer and brake, so you should pull over and stop the vehicle as soon as it is safe to do so.

 NOTICE

■ **To prevent battery discharge**

- Do not leave the “ENGINE START STOP” switch in ACCESSORY or IGNITION ON mode for long periods of time without the engine running.
- If the smart entry & start system indicator light (green) is illuminated, the “ENGINE START STOP” switch is not off. When exiting the vehicle, always check that the “ENGINE START STOP” switch is off.
- On vehicles with a Multidrive, do not stop the engine when the shift lever is in a position other than P. If the engine is stopped in another shift lever position, the “ENGINE START STOP” switch will not be turned off but instead be turned to ACCESSORY mode. If the vehicle is left in ACCESSORY mode, battery discharge may occur.

■ **When starting the engine**

- Do not race a cold engine.
- If the engine becomes difficult to start or stalls frequently, have the engine checked immediately.

■ **Symptoms indicating a malfunction with the “ENGINE START STOP” switch**

If the “ENGINE START STOP” switch seems to be operating somewhat differently than usual, such as the switch sticking slightly, there may be a malfunction. Contact any authorized Toyota dealer or repairer, or another duly qualified and equipped professional immediately.

2-1. Driving procedures

Multidrive*

Select a shift position appropriate for the driving conditions.

■ Shifting the shift lever

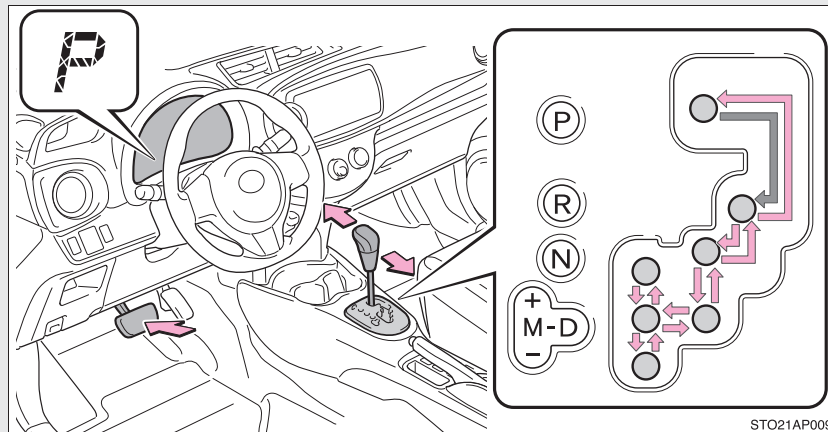

← Vehicles without a smart entry & start system

While the engine switch is in the “ON” position, move the shift lever with the brake pedal depressed.

When shifting the shift lever between P and D, make sure that the vehicle is completely stopped.

Vehicles with a smart entry & start system

While the “ENGINE START STOP” switch is in IGNITION ON mode, move the shift lever with the brake pedal depressed.

When shifting the shift lever between P and D, make sure that the vehicle is completely stopped.

2

When driving

*: If equipped

■ **Shift position purpose**

Shift position	Function
P	Parking the vehicle/starting the engine
R	Reversing
N	Neutral
D	Normal driving ^{*1}
M	7-speed sport sequential shiftmatic mode driving ^{*2} (→P. 181)

*1: To improve fuel consumption and reduce noises, set the shift lever in the D position for normal driving.

*2: Selecting gear step using the M position achieves suitable engine braking forces by operating shift lever.

■ **Selecting a driving mode**

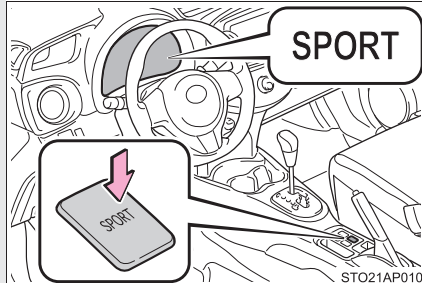

Press the switch.

For powerful acceleration and driving in mountainous regions.

The "SPORT" indicator will come on.

Press the switch once more to return the normal mode.

Changing gear steps in 7-speed sport sequential shiftmatic mode

Shift the shift lever to the M position and operate the shift lever or paddle shift switch.

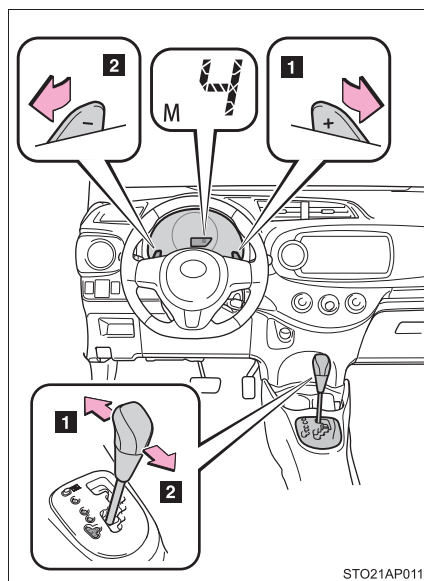

1 Upshifting

2 Downshifting

The gear step changes once every time the shift lever or paddle shift switch is operated.

The selected gear step, from 1 to 7, will be displayed in the multi-information display.

However, even when in the M position, the gear steps will be automatically changed if the engine speed is too high, or too low.

■ Gear step functions

- You can choose from 7 levels of engine braking force.
- A lower gear step will provide greater engine braking force than a higher gear step, and the engine speed will also increase.

2

When driving

Temporarily gear steps selection mode in the D position

To drive in temporary gear steps selection mode, operate the “-” and “+” paddle shift switch. The gear steps can then be selected by operating the “-” and “+” paddle shift switches. By selecting gear step using paddle shift switches, you can control engine braking forces.

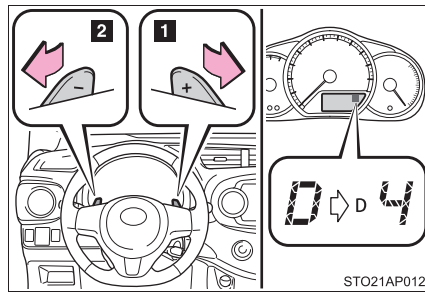

1 Upshifting

2 Downshifting

The gear step changes once every time the paddle shift switch is operated.

The selected gear step, from 1 to 7, will be displayed in the multi-information display

■ Gear step functions

→P. 181

■ Deactivation of the temporarily gear steps selection mode in the D position

In the following situations, temporarily gear steps selection mode in the D position will be deactivated:

- When the vehicle comes to a stop
- If the accelerator pedal is depressed for more than a certain period of time in one gear step
- When the “+” paddle shift switch is held down for a period of time

■ When driving with the cruise control system (if equipped)

Engine braking will not occur in 7-speed sport sequential shiftmatic mode, even when downshifting to 6, 5 or 4. (→P. 228)

■ When the vehicle comes to a stop with the shift lever in the M position

- The transmission will automatically downshift to M1 once the vehicle is stopped.
- After a stop, the vehicle will start off in M1.
- When the vehicle is stopped, the transmission is set at M1.

■ If the shift lever cannot be shifted from P

→P. 491

■ If the “M” indicator flashes or a buzzer beeps after shifting the shift lever to M

This may indicate a malfunction in the Multidrive system. Have the vehicle inspected by any authorized Toyota dealer or repairer, or another duly qualified and equipped professional immediately.

(In this situation, the transmission will operate in the same manner as when the shift lever is in D.)

■ Downshift restriction warning buzzer (vehicles with a 7-speed sport sequential shiftmatic mode)

To help ensure safety and driving performance, downshifting operation may sometimes be restricted. In some circumstances, downshifting may not be possible even when the shift lever or paddle shift switches are operated. (A buzzer will sound twice.)

2-1. Driving procedures

CAUTION

■ **When driving on slippery road surfaces**

Do not accelerate or shift gear steps suddenly.
Sudden changes in engine braking may cause the vehicle to spin or skid, resulting in an accident.

2-1. Driving procedures

Multi-mode manual transmission*

Select a shift position appropriate for the driving conditions.

■ Shifting the shift lever

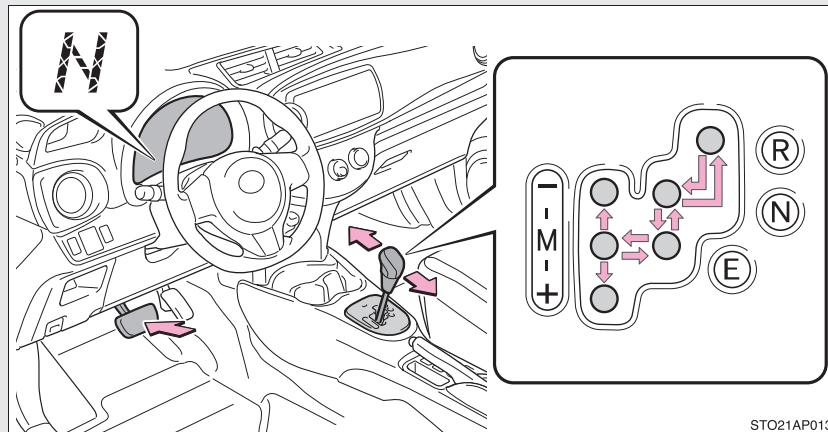

■ Shift position purpose

Shift position	Function
R	Reversing
N	Neutral or starting the engine
E	Easy (E) mode driving ^{*1}
M	Manual (M) mode driving ^{*2} (→P. 186)

*1: The most appropriate gear is automatically selected upon an operation of the accelerator pedal and vehicle speed.

*2: A gear must be selected manually. However, the gear may automatically be changed down optimally according to vehicle speed.

2

When driving

*: If equipped

■ **Selecting Easy sports (Es) mode (when the shift lever is in E only)**

Es mode can be selected for superior driving performance and to achieve a feeling of faster acceleration than in E mode.

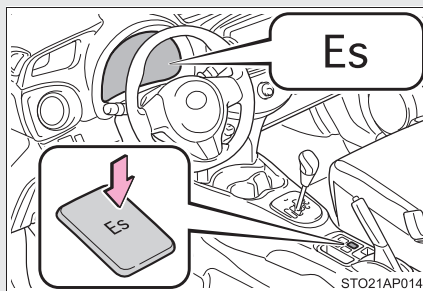

Turn Easy sports (Es) mode on/off

To improve fuel economy, cancel Es mode for ordinary driving.

Changing gears in M mode

When shift lever is in the M position, the shift lever or paddle shift switches can be operated as follows:

Shift lever

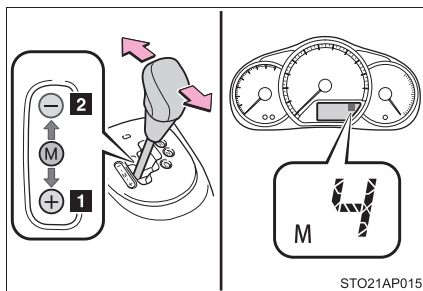

1 Upshifting

2 Downshifting

Shifting operation may be restricted depending on the vehicle speed.

Paddle shift switches

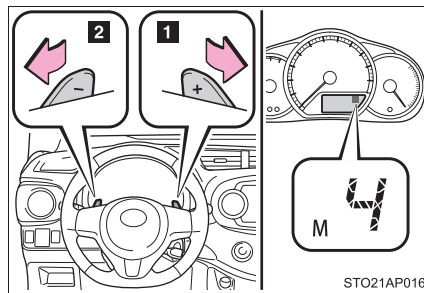

1 Upshifting

2 Downshifting

Shifting operation may be restricted depending on the vehicle speed.

Changing gears in E or Es mode

When the E or Es mode is selected, the paddle shift switches can be used as follows to select a gear temporarily.

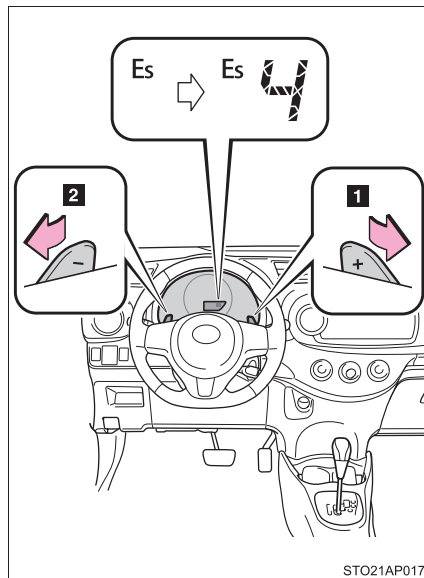

1 Upshifting

2 Downshifting

The gear will be displayed.

To return to E or Es mode, the “+” paddle shift switch must be held down for a period of time.

Shifting operation may be restricted depending on the vehicle speed.

■ **Maximum allowable speeds**

Observe the following maximum allowable speeds in each gear.

Gear	Maximum speed km/h (mph)
1	43 (27)
2	80 (50)
3	117 (73)
4	158 (98)
5	—

■ **Es mode automatic deactivation**

Es mode is automatically deactivated if the “ENGINE START STOP” switch (vehicles with a smart entry & start system) or the engine switch (vehicles without a smart entry & start system) is turned off after driving in Es mode.

■ **If the shift lever cannot be shifted**

- With the shift lever in N
Depress the brake pedal to shift the shift lever. If the shift lever cannot be shifted with your foot on the brake, there may be a problem with the shift lock system. (→P. 492)
- With the shift lever in a position other than N
→P. 492

■ **If the driver's door is opened when the shift lever is in a position other than N and the engine is running**

A buzzer will sound. Close the driver's door.

■ **If the parking brake is set when the shift lever is in a position other than N with engine running**

- When the driver's door is opened
A buzzer will sound and the gear position will automatically change to N in 10 seconds.
- When the driver's door is closed
A buzzer will sound and the gear position will automatically change to N in 90 seconds.

■ **If the “M” indicator does not come on even after shifting the shift lever to M**

This may indicate a malfunction in the multi-mode manual transmission system. Have the vehicle inspected by any authorized Toyota dealer or repairer, or another duly qualified and equipped professional immediately.

(In this situation, the transmission will operate in the same manner as when the shift lever is in E.)

■ **If the “N” indicator is flashing**

● **When shifting the shift lever**

Shift the shift lever to N. Wait a few seconds and shift the shift lever to the desired position.

● **When the engine is turned off**

Vehicles without smart entry & start system: Turn the engine switch to the “ON” position. Depress the brake pedal and shift the shift lever to N, and then to the desired position.

Vehicles with smart entry & start system: Turn the “ENGINE START STOP” switch to IGNITION ON mode. Depress the brake pedal and shift the shift lever to N, and then to the desired position.

If the indicator still flashes after the above operations, shift the shift lever to N and start the engine. Then, shift the shift lever to the desired position.

■ **If the “N” indicator is flashing and warning buzzer is beeping**

Shift the shift lever to N, and then to E, M or R.

■ **Reverse warning buzzer**

When shifting into R, a buzzer will sound to inform the driver that the shift lever is in R.

■ **Downshift restriction warning buzzer (in E mode [when the paddle shift switches are operated] or M mode)**

To help ensure safety and driving performance, downshifting operation may sometimes be restricted. In some circumstances, downshifting may not be possible even when the shift lever or paddle shift switches are operated. (A buzzer will sound twice.)

2-1. Driving procedures

Manual transmission*

■ Shifting the shift lever

Vehicles with a 5-speed transmission

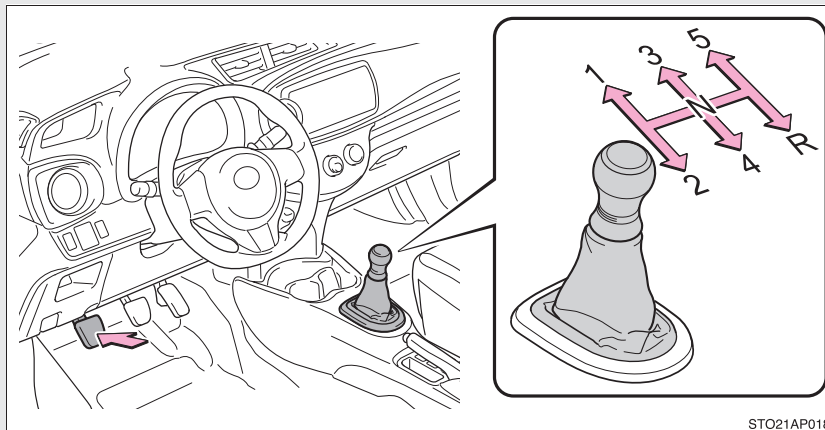

Fully depress the clutch pedal before operating the shift lever, and then release it slowly.

If it is difficult to shift in reverse, shift the shift lever to N, release the clutch pedal momentarily, and then try again.

*: If equipped

Vehicles with a 6-speed transmission

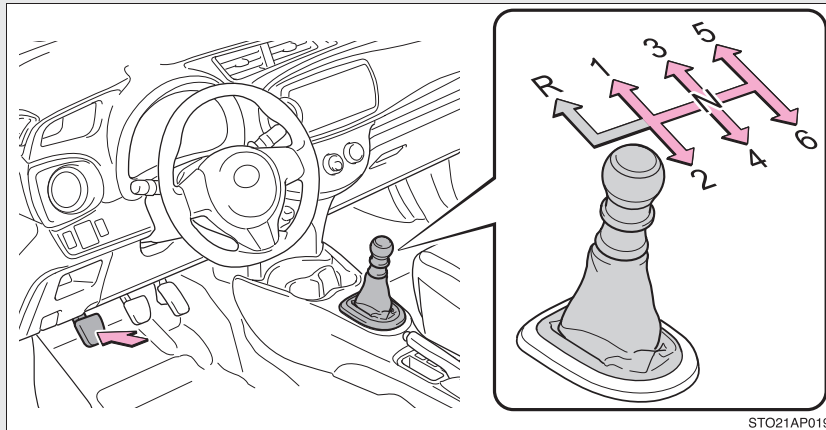

Fully depress the clutch pedal before operating the shift lever, and then release it slowly.

■ Shifting the shift lever to R (vehicles with a 6-speed transmission)

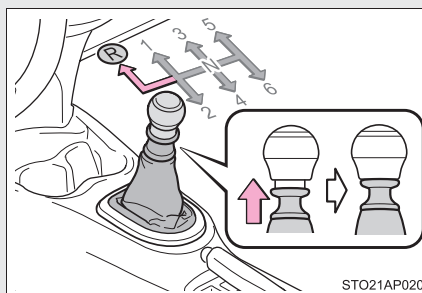

Shift the shift lever to R while lifting up the ring section.

2

When driving

Gear Shift Indicator

The Gear Shift Indicator is a guide to help the driver achieve improved fuel economy and reduced exhaust emissions within limits of engine performance.

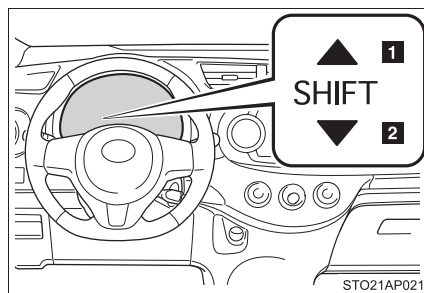

- 1 Upshifting
- 2 Downshifting

■ Gear Shift Indicator display

The Gear Shift Indicator may not be displayed when your foot is placed on the clutch pedal.

■ Maximum downshifting speed

Observe the downshifting speeds in the following table to prevent over-revving the engine.

Shift position	Maximum speed km/h (mph)		
	1KR-FE engine	1NR-FE engine	1ND-TV engine
1	45 (28)	46 (29)	43 (27)
2	84 (52)	85 (53)	80 (50)
3	123 (76)	124 (77)	117 (73)
4	157 (98)	158 (98)	158 (98)

⚠ CAUTION**■ Gear Shift Indicator display**

Refer to the display while considering actual traffic and road conditions. Failure to exercise judgment may lead to an accident.

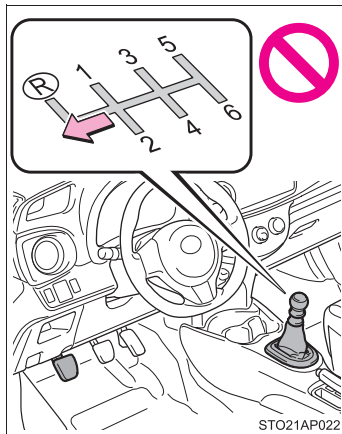
⚠ NOTICE**■ To prevent damage to the transmission (vehicles with a 6-speed transmission)**

- Do not shift the shift lever to R without depressing the clutch pedal.

- Do not lift up the ring section except when shifting the lever to R.
- Shift the shift lever to R only when the vehicle is stationary.

2-1. Driving procedures

Turn signal lever

The turn signal lever can be used to show the following intentions of the driver:

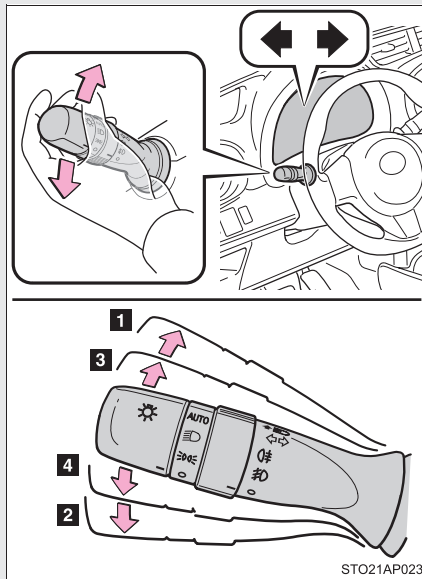

- 1 Right turn
- 2 Left turn
- 3 Lane change to the right (push and hold the lever partway)

The right hand signals will flash until you release the lever.

- 4 Lane change to the left (push and hold the lever partway)

The left hand signals will flash until you release the lever.

■ Turn signals can be operated when

Vehicles without a smart entry & start system:

The engine switch is in the "ON" position.

Vehicles with a smart entry & start system:

The "ENGINE START STOP" switch is in IGNITION ON mode.

■ If the indicator flashes faster than usual

Check that a light bulb in the front or rear turn signal lights has not burned out.

2-1. Driving procedures

Parking brake

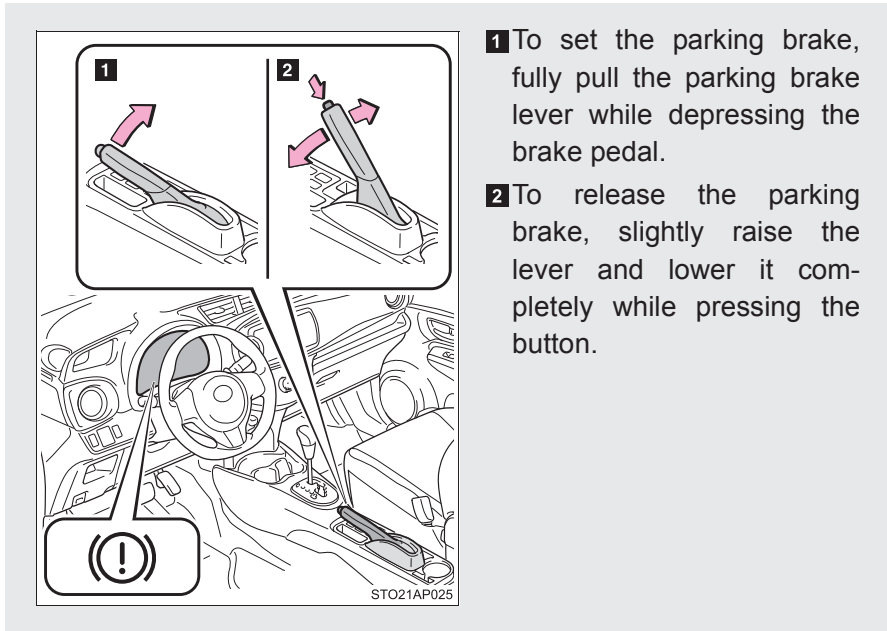

2

When driving

■ Usage in winter time

See “Winter driving tips” for parking brake usage in winter time. (→P. 252)

⚠ NOTICE

■ Before driving

Fully release the parking brake.

Driving the vehicle with the parking brake set will lead to brake components overheating, which may affect braking performance and increase brake wear.

2-1. Driving procedures

Horn

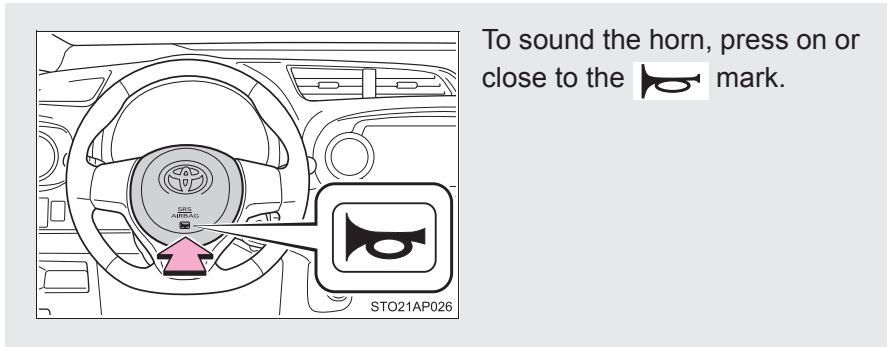

To sound the horn, press on or close to the  mark.

■ After adjusting the steering wheel

Make sure that the steering wheel is securely locked.

The horn may not sound if the steering wheel is not securely locked.

(→P. 91)

2-2. Instrument cluster Gauges and meters

Vehicles without a tachometer (type A)

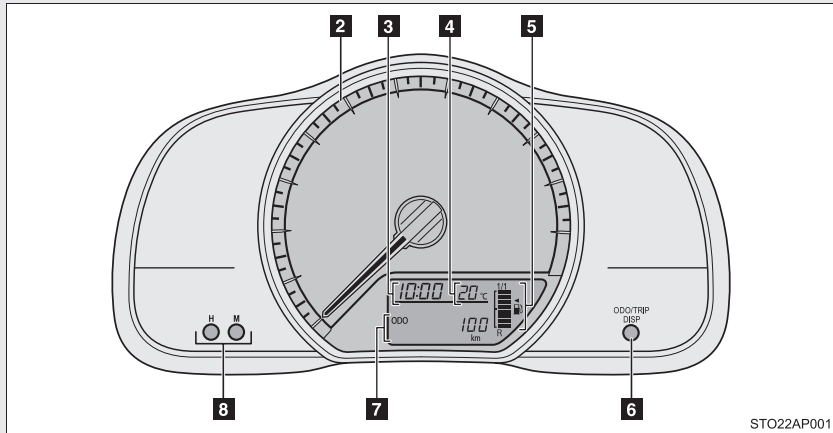

Vehicles without a tachometer (type B)

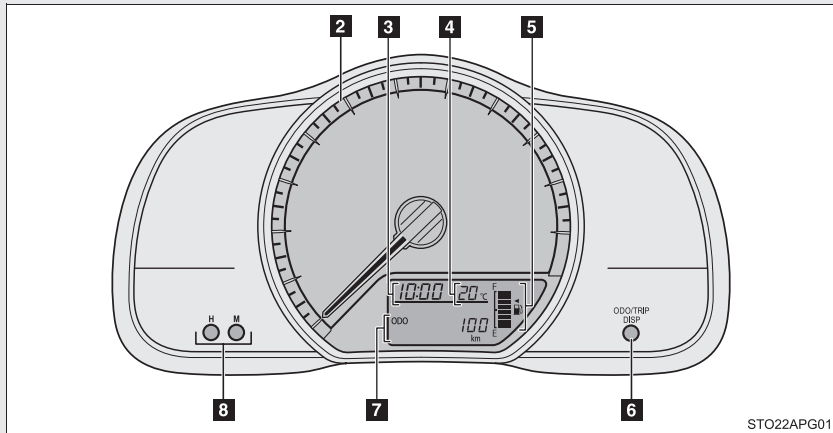

2

When driving

2-2. Instrument cluster

Vehicles with a tachometer (type A)

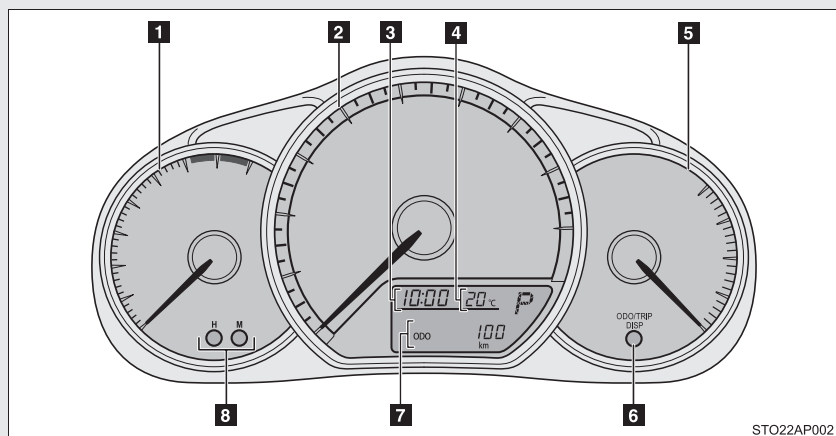

Vehicles with a tachometer (type B)

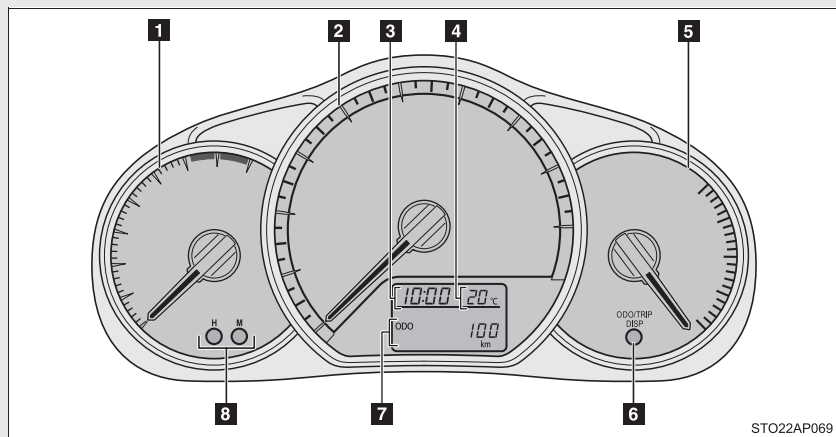

1 Tachometer

Displays the engine speed in revolutions per minute.

2 Speedometer

Displays the vehicle speed.

3 Clock

→P. 338

4 Outside temperature display

→P. 339

5 Fuel gauge

Displays the quantity of fuel remaining in the tank.

6 Display change button

→P. 209

7 Odometer, trip meter and multi-information display

→P. 208, 209

8 Clock adjusting buttons

→P. 338

2

When driving

■ **The meters and display operate when**

Vehicles without a smart entry & start system:
The engine switch is in the “ON” position.

Vehicles with a smart entry & start system:
The “ENGINE START STOP” switch is in IGNITION ON mode.

 NOTICE

■ **To prevent damage to the engine and its components**

- Vehicles with a tachometer: Do not let the indicator needle of the tachometer enter the red zone, which indicates the maximum engine speed.
- The engine may be overheating if the high engine coolant temperature warning light flashes or turns on. In this case, immediately stop the vehicle in a safe place, and check the engine after it has cooled completely. (→P. 505)

2-2. Instrument cluster Indicators and warning lights

The indicators and warning lights on the instrument cluster and center panel inform the driver of the status of the vehicle's various systems.

Instrument cluster (vehicles without a tachometer type A)

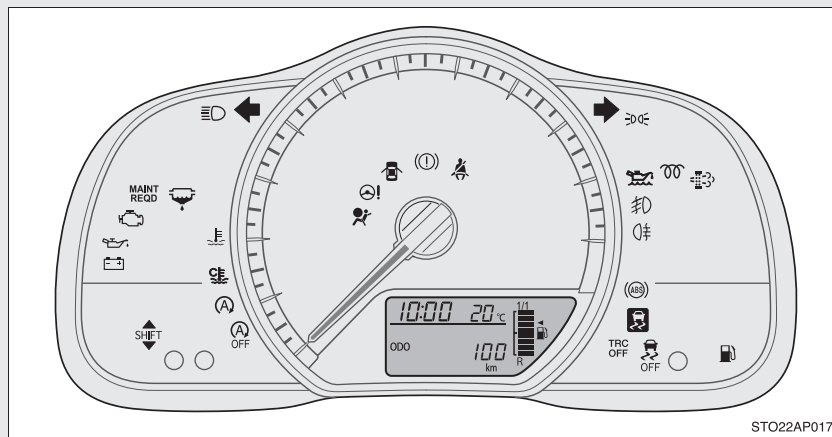

Instrument cluster (vehicles without a tachometer type B)

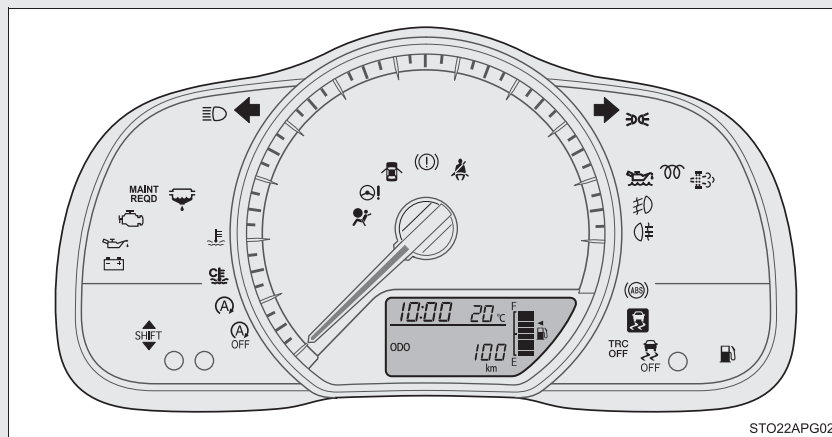

2

When driving

2-2. Instrument cluster

Instrument cluster (vehicles with a tachometer type A)

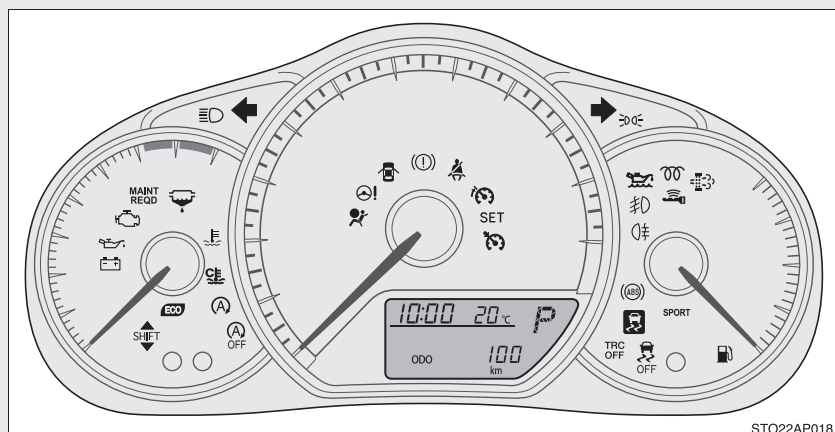

Instrument cluster (vehicles with a tachometer type B)

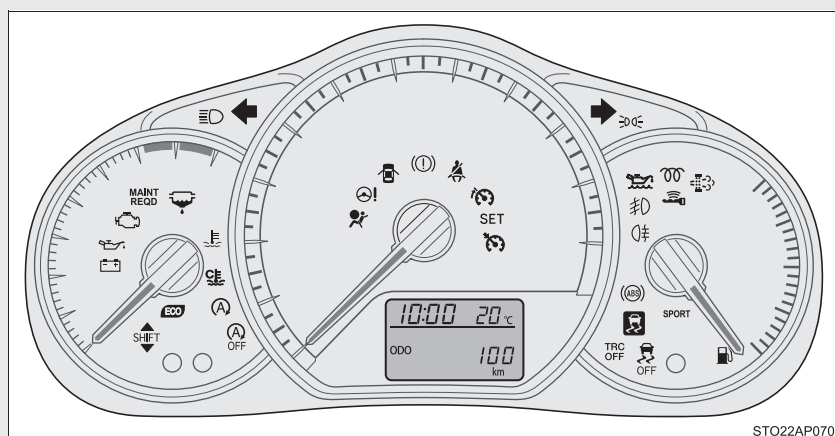

Center panel (left-hand drive vehicles)

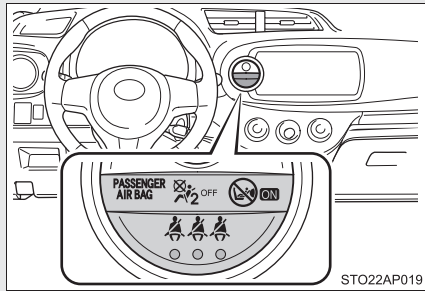

Center panel (right-hand drive vehicles)

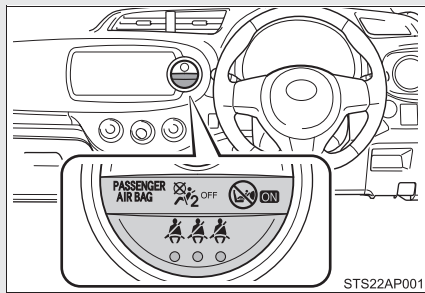























2

When driving

■ Indicators

The indicators inform the driver of the operating state of the vehicle's various systems.

	Turn signal indicator (→P. 194)		Shift position and gear position indicators (→P. 185)
	Headlight high beam indicator (→P. 215)		"SPORT" indicator (→P. 180)
	Tail light indicator (if equipped) (→P. 214)		Gear Shift Indicator (→P. 192)
	Front fog light indicator (if equipped) (→P. 220)		Cruise control indicator (→P. 228)
	Rear fog light indicator (→P. 220)		"SET" indicator (→P. 228)
	Smart entry & start system indicator (→P. 169)		Speed limiter indicator (→P. 232)
	Low engine coolant temperature indicator		Stop & Start indicator (→P. 235)
	Engine preheating indicator (→P. 165, 169) (diesel engine)		Stop & Start cancel indicator (→P. 237)
	Eco Driving Indicator Light (→P. 154) (if equipped)		Slip indicator (→P. 244)
	Shift position and gear step position indicators (→P. 179) (vehicles with a Multidrive)		

<p>^{*1}  (if equipped)</p>	<p>“TRC OFF” indicator (→P. 244)</p>	<p></p>	<p>“PASSENGER AIR BAG” indicator (→P. 122)</p>
<p>^{*1}  (if equipped)</p>	<p>VSC OFF indicator (→P. 244)</p>		

^{*1}: These lights turn on when the engine switch is turned to the “ON” position (vehicles without a smart entry & start system) or the “ENGINE START STOP” switch is turned to IGNITION ON mode (vehicles with a smart entry & start system) to indicate that a system check is being performed. They will turn off after the engine is started, or after a few seconds. There may be a malfunction in a system if a light does not come on, or if the lights do not turn off. Have the vehicle inspected by any authorized Toyota dealer or repairer, or another duly qualified and equipped professional.

^{*2}: The light turns on when the engine coolant temperature is low.

^{*3}: The light flashes to indicate that the system is operating.

2

When driving

■ Warning lights

Warning lights inform the driver of malfunctions in any of the vehicle's systems. (→P. 444)

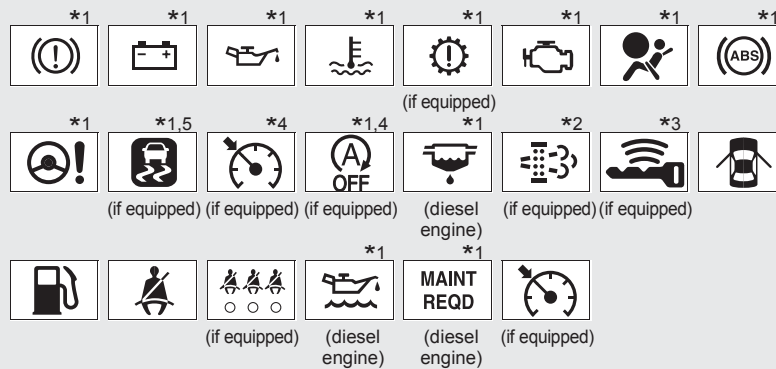

*1: These lights turn on when the engine switch is turned to the “ON” position (vehicles without a smart entry & start system) or the “ENGINE START STOP” switch is turned to IGNITION ON mode (vehicles with a smart entry & start system) to indicate that a system check is being performed. They will turn off after the engine is started, or after a few seconds. There may be a malfunction in a system if a light does not come on, or if the lights do not turn off. Have the vehicle inspected by any authorized Toyota dealer or repairer, or another duly qualified and equipped professional.

*2: These lights turn on when the engine switch is turned to the “ON” position (vehicles without a smart entry & start system) or the “ENGINE START STOP” switch is turned to IGNITION ON mode (vehicles with a smart entry & start system) to indicate that a system check is being performed. They will turn off after the engine is started, or after a few seconds.

*3: The light flashes in yellow to indicate a malfunction. The light flashes quickly in green to indicate that the steering lock has not been released.

*4: The light flashes to indicate a malfunction.

*5: The light turns on to indicate a malfunction.

 CAUTION

■ **If a safety system warning light does not come on**

Should a safety system light such as the ABS and SRS warning light not come on when you start the engine, this could mean that these systems are not available to help protect you in an accident, which could result in death or serious injury. Have the vehicle inspected by any authorized Toyota dealer or repairer, or another duly qualified and equipped professional immediately if this occurs.

2

When driving

2-2. Instrument cluster

Multi-information display

The multi-information display presents the driver with a variety of driving-related data.

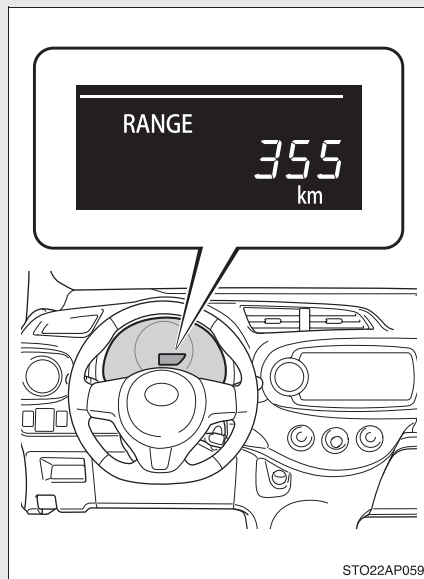

- Odometer (→P. 209)
- Trip meter (→P. 210)
- Stop & Start system operation time (if equipped) (→P. 210)
- Stop & Start system total operation time (if equipped) (→P. 211)
- Trip information (→P. 211)
Displays driving range, fuel consumption and other cruising-related information.
- Instrument panel light control (→P. 212)
- Eco Driving Indicator Light customization (if equipped) (→P. 213)

Changing the display

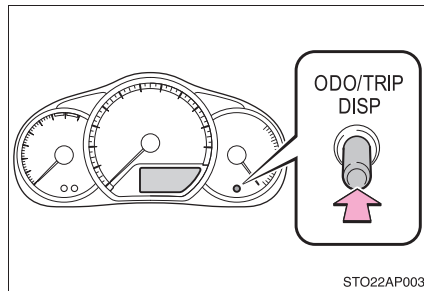

Items displayed can be switched by pressing the display change button.

Display items

■ Odometer

Type A

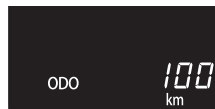

Displays the total distance the vehicle has been driven.

Type B



2

When driving

■ Trip meter

Type A



Displays the distance the vehicle has been driven since the meter was last reset. Trip meters A and B can be used to record and display different distances independently.

Pressing and holding the display change button will reset the trip meter that is currently displayed.

Type B



Type C

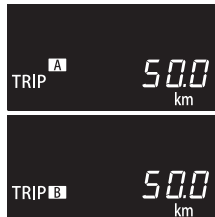

■ Stop & Start system operation time (if equipped)

Type A



Displays the amount of time the engine was stopped due to operation of the Stop & Start system during the current trip.

Vehicles without a smart entry & start system:

Type B



From the engine switch in the “ON” position to the engine switch in the “LOCK” position.

Vehicles with a smart entry & start system:

From the “ENGINE START STOP” switch in IGNITION ON mode to the “ENGINE START STOP” switch off.

■ Stop & Start system total operation time (if equipped)

Type A



Displays the total amount of time that the engine has been stopped due to operation of the Stop & Start system since the system was last reset.

Press and hold the button to reset.

Type B



■ Instantaneous fuel consumption

Type A



Displays instantaneous fuel consumption.

Type B



■ Average fuel consumption

Type A

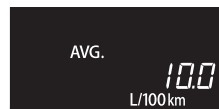

Displays the average fuel consumption since the function was reset.

- The function can be reset by pressing and holding the display change button when the average fuel consumption is displayed.
- Use the displayed average fuel consumption as a reference.

Type B



2

When driving

■ Driving range

Type A



Type B



Displays the estimated maximum distance that can be driven with the quantity of fuel remaining.

- This distance is computed based on your average fuel consumption. As a result, the actual distance that can be driven may differ from that displayed.
- When only a small amount of fuel is added to the tank, the display may not be updated.

Vehicles without a smart entry & start system:

When adding fuel, turn the engine switch to the “LOCK” position. In case fuel is added without turning the engine switch to the “LOCK” position, the display may not be updated.

Vehicles with a smart entry & start system:

When adding fuel, turn the “ENGINE START STOP” switch to off. In case fuel is added without turning the “ENGINE START STOP” switch to off, the display may not be updated.

■ Average vehicle speed

Type A



Type B



Displays the average vehicle speed since the engine was started or the function was reset.

The function can be reset by pressing and holding the display change button when the average vehicle speed is displayed.

■ Instrument panel light control



Displays the brightness of the instrument panel lights when the headlight switch is on.

Pressing and holding the button will adjust brightness of the instrument panel lights.

Eco Driving Indicator Light customization (if equipped)

Eco Driving Indicator Light can be activated or deactivated by pressing the display change button when the Eco Driving Indicator Light customization display is displayed.



To change the Eco Driving Indicator Light customization display, display the odometer and press and hold the display change button until the display changes.

2

When driving

■ When disconnecting and reconnecting battery terminals

The following information data will be reset:

- Stop & Start system total operation time (if equipped)
- Average fuel consumption
- Driving range
- Average vehicle speed

⚠ NOTICE**■ The multi-information display at low temperatures**

Allow the interior of the vehicle to warm up before using the liquid crystal information display. At extremely low temperatures, the information display monitor may respond slowly, and display changes may be delayed.

2-3. Operating the lights and wipers

Headlight switch

The headlights can be operated manually or automatically.

Turning the end of the lever turns on the lights as follows:

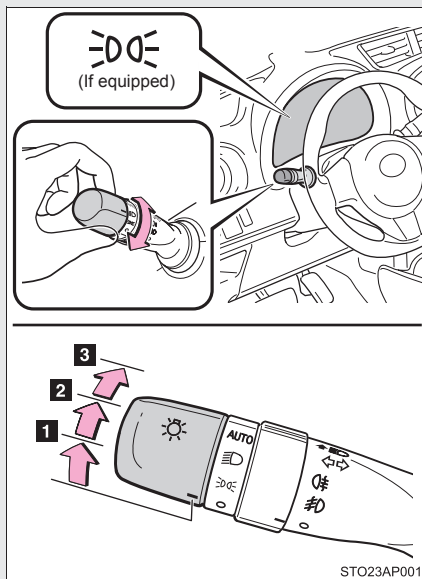

1  The front position, tail, license plate and instrument panel lights turn on.

2  The headlights and all the lights listed above turn on.

3 **AUTO** (If equipped) Vehicles without a smart entry & start system: The headlights, front position lights and so on turn on and off automatically (when the engine switch is in the "ON" position.)

Vehicles with a smart entry & start system: The headlights, front position lights and so on turn on and off automatically (when the "ENGINE START STOP" switch is in IGNITION ON mode.)

Turning on the high beam headlights

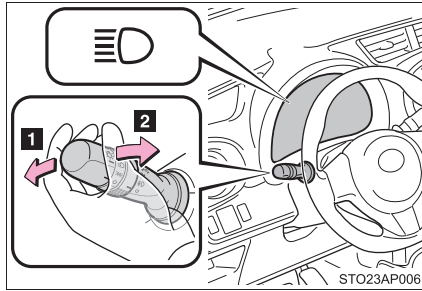

1 With the headlights on, push the lever away from you to turn on the high beams.

Pull the lever toward you to the center position to turn the high beams off.

2 Pull the lever toward you and release it to flash the high beams once.

You can flash the high beams with the headlights on or off.

2

When driving

Manual headlight leveling dial

The level of the headlights can be adjusted according to the number of passengers and the loading condition of the vehicle.

Left-hand drive vehicles

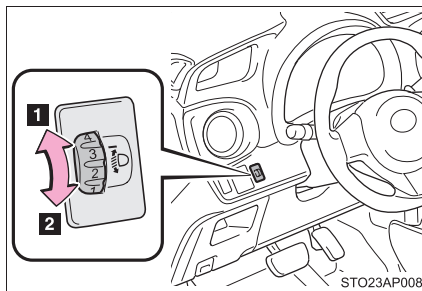

1 Raises the level of the headlights

2 Lowers the level of the headlights

Right-hand drive vehicles

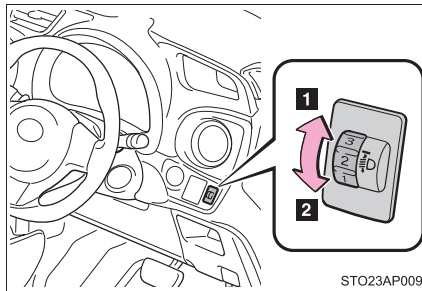

- 1** Raises the level of the head-lights
- 2** Lowers the level of the head-lights

■ **Guide to dial settings**

Vehicle category M1*

Loading condition	Control switch position
Driver only or driver + one passenger in the front seat	0
All passengers	1.5
All passengers + full luggage loading to the luggage room	2
Driver + full luggage loading to the luggage room	4

Vehicle category N1*

Loading condition	Control switch position
Driver only or driver + one passenger in the front seat	0
Driver + full luggage loading to the luggage room	3.5

*: To distinguish the vehicle category, ask any authorized Toyota dealer or repairer, or another duly qualified and equipped professional.

■ Daytime running light system (if equipped)

To make your vehicle more visible to other drivers, the headlights and tail lights turn on automatically whenever the engine is started. Daytime running lights are not designed for use at night.

■ Headlight control sensor (if equipped)

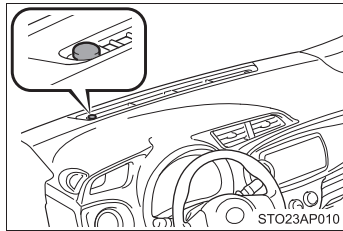





The sensor may not function properly if an object is placed on the sensor, or anything that blocks the sensor is affixed to the windshield.

Doing so interferes with the sensor detecting the level of ambient light and may cause the automatic headlight system to malfunction.



■ Automatic light off system (if equipped)

Vehicles without a smart entry & start system



- When the light switch is in  or  : The headlights and front fog lights turn off automatically when the engine switch is turned to the "LOCK" position.
- When the light switch is in **AUTO** : The headlights and all the lights turn off automatically when the engine switch is turned to the "LOCK" position.

To turn the lights on again, turn the engine switch to the "ON" position, or turn the light switch off once and then back to  or  .

Vehicles with a smart entry & start system

- When the light switch is in  or  : The headlights and front fog lights turn off automatically when the “ENGINE START STOP” switch is turned off.
- When the light switch is in **AUTO** : The headlights and all the lights turn off automatically when the “ENGINE START STOP” switch is turned off.

To turn the lights on again, turn the “ENGINE START STOP” switch to IGNITION ON mode, or turn the light switch off once and then back to

 or  .

■ Light reminder buzzer

Vehicles without a smart entry & start system:

With the key removed from the engine switch, if the driver door is opened while the lights are turned on, a buzzer will sound.

Vehicles with a smart entry & start system:

With the “ENGINE START STOP” switch turned OFF, if the driver door is opened while the lights are turned on, a buzzer will sound.

■ Battery-saving function

In all conditions following below, the headlights and the other remaining lights will go off automatically after 20 minutes in order to prevent the vehicle battery from being discharged:

- The engine switch is in the “LOCK” position (vehicle without a smart entry & start system) or the “ENGINE START STOP” switch is in off (vehicle with a smart entry & start system).
- The headlights and/or tail lights are on.
- The light switch is in  or **AUTO** .

This function will be canceled in any of the following situations:

- When the engine switch is turned to the “ON” position (vehicle without a smart entry & start system) or the “ENGINE START STOP” switch is turned to IGNITION ON mode (vehicle with a smart entry & start system).
- When the light switch is operated.
- When the door is opened or closed.

■ Turning on the low beam headlights when the vehicle is parked in dark areas

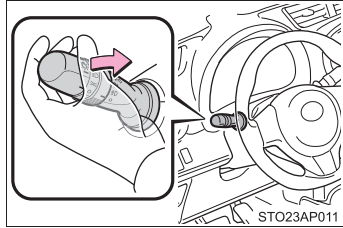

Turn off the engine with the light switch in **AUTO** or off, and pull the light switch toward you and release it. The low beam headlights will turn on for about 30 seconds to light up the area around the vehicle.

The lights are turned off in the following situations.

- Vehicles without a smart entry & start system:
The engine switch is turned to the “ON” position.
- Vehicles with a smart entry & start system:
The “ENGINE START STOP” switch is turned to IGNITION ON mode.
- The light switch is turned on.
- The light switch is pulled toward you and then released.

■ Customization that can be configured at any authorized Toyota dealer or repairer, or another duly qualified and equipped professional

Settings (e.g. light sensor sensitivity) can be changed.
(Customizable features →P. 542)

⚠ NOTICE

■ To prevent battery discharge

Do not leave the lights on longer than necessary when the engine is not running.

2-3. Operating the lights and wipers

Fog light switch

The fog lights secure excellent visibility in difficult driving conditions, such as in rain and fog.

■ Rear fog light switch (if equipped)

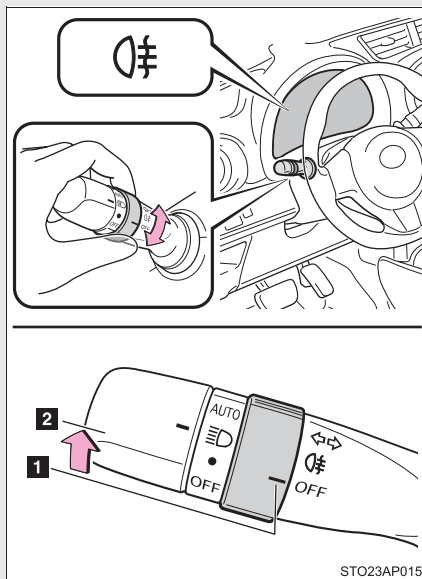

1 Turns the rear fog light off

2 Turns the rear fog light on

Releasing the switch ring returns it to the original position.

Operating the switch ring again turns the light off.

■ Front and rear fog light switch (if equipped)

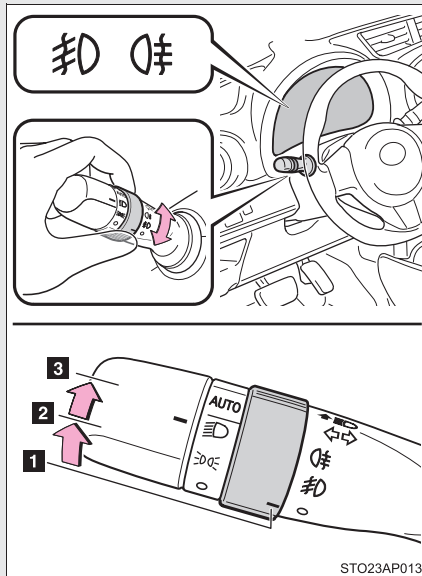

- 1 Turns the front and rear fog lights off
- 2 Turns the front fog lights on
- 3 Turns both front and rear fog lights on

Releasing the switch ring returns it to .

Operating the switch ring again turns only the rear fog lights off.

2

When driving

■ Fog lights can be used when

Vehicles with a rear fog light switch

The headlights are turned on.

Vehicles with front and rear fog light switch

Front fog lights: The headlights or front position lights are turned on.

Rear fog lights: The front fog lights are turned on.

2-3. Operating the lights and wipers Windshield wiper and washer

Intermittent windshield wiper (if equipped)

The wiper operation is selected by moving the lever as follows:

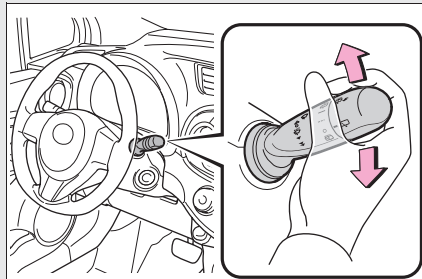

- 1 Intermittent windshield wiper operation
- 2 Low speed windshield wiper operation
- 3 High speed windshield wiper operation
- 4 Temporary operation

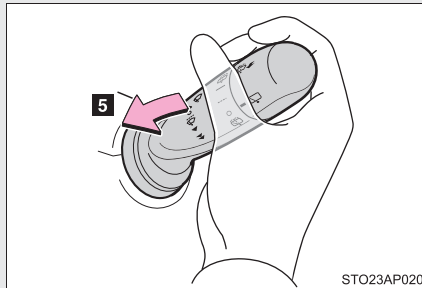
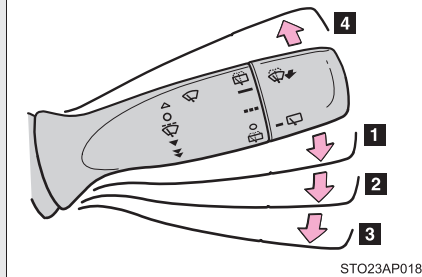

- 5 Washer/wiper dual operation

The wiper will automatically operate a couple of times after the washer squirts.

Rain-sensing windshield wiper (if equipped)

When “AUTO” is selected, the wiper will operate automatically when the sensor detects falling rain. The system automatically adjusts wiper timing in accordance with rain volume and vehicle speed.

When “AUTO” is selected, the sensor sensitivity can be adjusted as follows by turning the switch ring:

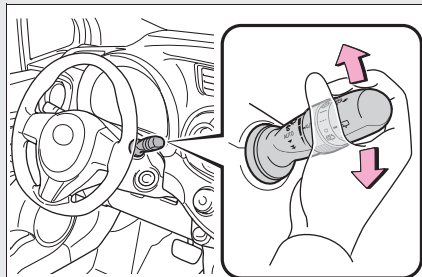

- 1 Rain-sensing wiper operation (“AUTO”)
- 2 Low speed wiper operation
- 3 High speed wiper operation
- 4 Temporary operation

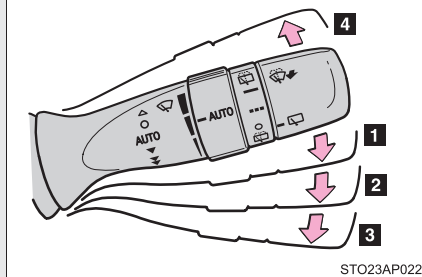

STO23AP022

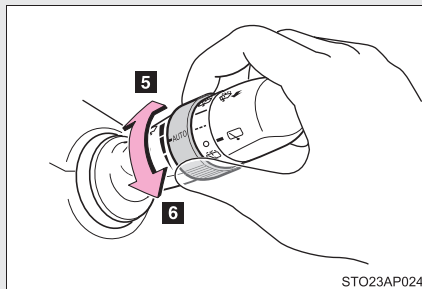

STO23AP024

- 5 Increases the sensitivity
- 6 Decreases the sensitivity

2

When driving

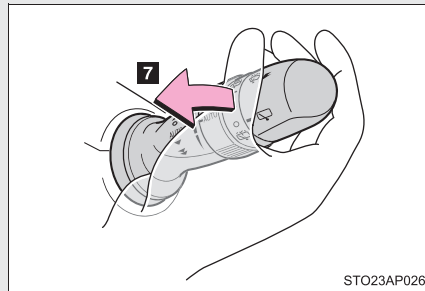

7 Washer/wiper dual operation

The wiper will automatically operate a couple of times after the washer squirts.

(After operating several times, the wiper operate one more time after a short delay to prevent dripping.)

■ **The windshield wiper and washer can be operated when**

Vehicles without a smart entry & start system:
The engine switch is in the “ON” position.

Vehicles with a smart entry & start system:
The “ENGINE START STOP” switch is in IGNITION ON mode.

■ **Raindrop sensor (vehicles with a rain-sensing windshield wiper)**

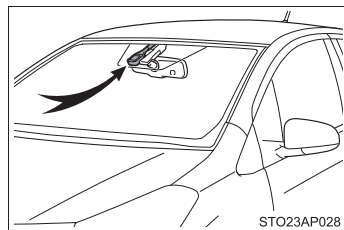

- The raindrop sensor judges the amount of raindrops.

An optical sensor is adopted. It may not operate properly when sunlight from the rising or setting of the sun intermittently strikes the windshield, or if bugs etc. are present on the windshield.

Vehicles without a smart entry & start system

- If the wiper switch is turned to the “AUTO” position while the engine switch is in the “ON” position, the wiper will operate once to show that “AUTO” mode is activated.
- When the sensor sensitivity ring is turned toward high while in “AUTO” mode, the wiper will operate once to indicate that the sensor sensitivity is enhanced.
- If the temperature of the raindrop sensor is 90°C (194°F) or higher, or -15°C (5°F) or lower, automatic operation may not occur. In this case, operate the wiper in any mode other than “AUTO”.

Vehicles with a smart entry & start system

- If the wiper switch is turned to the “AUTO” position while the “ENGINE START STOP” switch is in IGNITION ON mode, the wiper will operate once to show that “AUTO” mode is activated.
- When the sensor sensitivity ring is turned toward high while in “AUTO” mode, the wiper will operate once to indicate that the sensor sensitivity is enhanced.
- If the temperature of the raindrop sensor is 90°C (194°F) or higher, or -15°C (5°F) or lower, automatic operation may not occur. In this case, operate the wiper in any mode other than “AUTO”.

■ If no windshield washer fluid sprays

Check that the washer nozzles are not blocked if there is washer fluid in the windshield washer fluid reservoir.

⚠ CAUTION**■ Caution regarding the use of windshield wiper in “AUTO” mode (vehicles with a rain-sensing windshield wiper)**

The windshield wiper may operate unexpectedly if the sensor is touched or the windshield is subject to vibration in “AUTO” mode. Take care that your fingers etc. do not become caught in the windshield wiper.

⚠ NOTICE**■ When the windshield is dry**

Do not use the wiper, as they may damage the windshield.

■ When the washer fluid tank is empty

Do not operate the switch continually as the washer fluid pump may overheat.

■ When a nozzle becomes blocked

In this case, contact any authorized Toyota dealer or repairer, or another duly qualified and equipped professional.

Do not try to clear it with a pin or other object. The nozzle will be damaged.

2-3. Operating the lights and wipers

Rear window wiper and washer

The wiper operation is selected by moving the lever as follows:

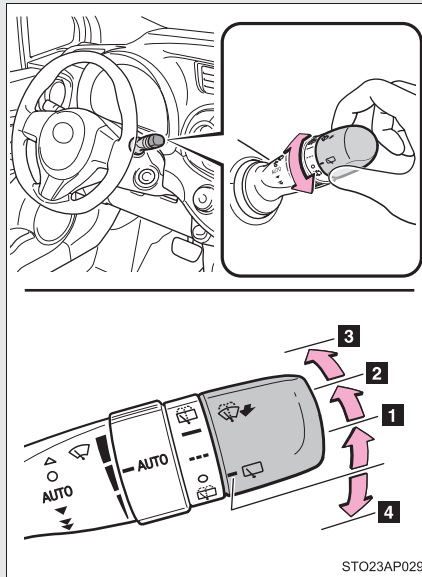

- 1 Intermittent window wiper operation
- 2 Normal window wiper operation
- 3 Washer/wiper dual operation
- 4 Washer/wiper dual operation

The wiper will automatically operate a couple of times after the washer squirts.

■ The rear window wiper and washer can be operated when

Vehicles without a smart entry & start system:

The engine switch is in the "ON" position.

Vehicles with a smart entry & start system:

The "ENGINE START STOP" switch is in IGNITION ON mode.

■ If no washer fluid sprays

Check that the washer nozzle is not blocked if there is washer fluid in the washer fluid reservoir.

 NOTICE

■ **When the rear window is dry**

Do not use the wiper, as it may damage the rear window.

■ **When the washer fluid tank is empty**

Do not operate the switch continually as the washer fluid pump may over-heat.

■ **When a nozzle becomes blocked**

In this case, contact any authorized Toyota dealer or repairer, or another duly qualified and equipped professional.

Do not try to clear it with a pin or other object. The nozzle will be damaged.

2-4. Using other driving systems

Cruise control*

Use the cruise control to maintain a set speed without depressing the accelerator pedal.

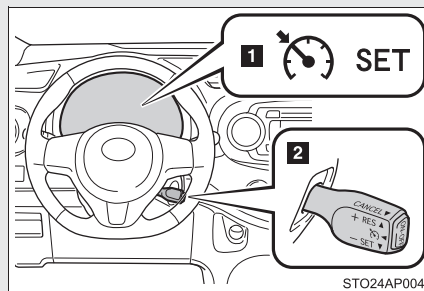

- 1 Indicators
- 2 Cruise control switch

■ Setting the vehicle speed

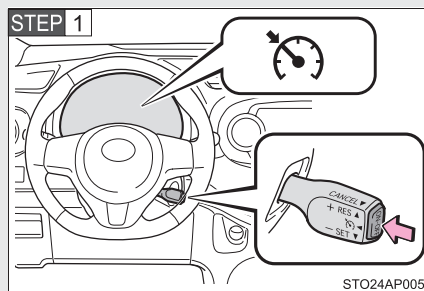

Press the "ON-OFF" button to activate the cruise control.

Cruise control indicator will come on.

Press the button again to deactivate the cruise control.

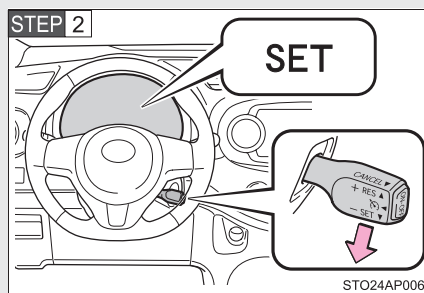

Accelerate or decelerate the vehicle to the desired speed, and push the lever down to set the speed.

"SET" indicator will come on.

The vehicle speed at the moment the lever is released becomes the set speed.

*: If equipped

■ **Adjusting the set speed**

To change the set speed, operate the lever until the desired set speed is obtained.

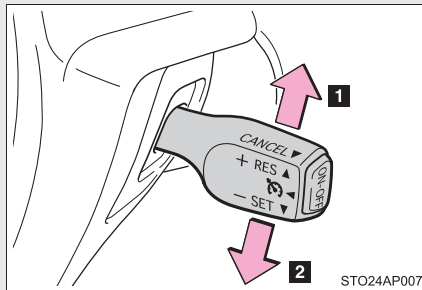

- 1 Increases the speed
- 2 Decreases the speed

Fine adjustment: Momentarily move the lever in the desired direction.

Large adjustment: Hold the lever in the desired direction.

The set speed will be increased or decreased as follows:

Fine adjustment: By approximately 1.6 km/h (1 mph) each time the lever is operated.

Large adjustment: The set speed can be increased or decreased continually until the lever is released.

■ **Cancelling and resuming the constant speed control**

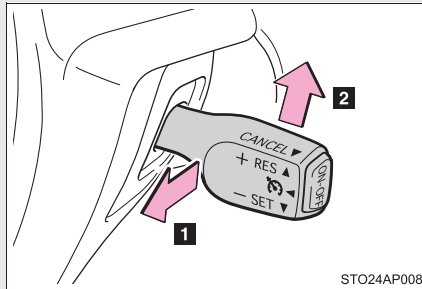

- 1 Pulling the lever toward you cancels the constant speed control.

The speed setting is also canceled when the brakes are applied or the clutch pedal (manual transmission only) is depressed.

- 2 Pushing the lever up resumes the constant speed control.

Resuming is available when the vehicle speed is more than approximately 40 km/h (25 mph).

■ **Cruise control can be set when**

- Vehicles with a Multidrive: The shift lever is in the D or range 4 or higher of M has been selected.
- Vehicles with a paddle shift switch: Range 4 or higher has been selected by using the paddle shift.
- Vehicle speed is above approximately 40 km/h (25 mph).

■ **Accelerating after setting the vehicle speed**

- The vehicle can be accelerated normally. After acceleration, the set speed resumes.
- Even without cancelling the cruise control, the set speed can be increased by first accelerating the vehicle to the desired speed and then pushing the lever down to set the new speed.

■ **Automatic cruise control cancellation**

Cruise control will stop maintaining the vehicle speed in any of the following situations.

- Actual vehicle speed falls more than approximately 16 km/h (10 mph) below the preset vehicle speed.
At this time, the memorized set speed is not retained.
- Actual vehicle speed is below approximately 40 km/h (25 mph).
- VSC is activated (if equipped).
- Speed limiter is activated.

■ **If the cruise control indicator light flashes**

Press the “ON-OFF” button once to deactivate the system, and then press the button again to reactivate the system.

If the cruise control speed cannot be set or if the cruise control cancels immediately after being activated, there may be a malfunction in the cruise control system. Have the vehicle inspected by any authorized Toyota dealer or repairer, or another duly qualified and equipped professional.

 CAUTION

■ **To avoid operating the cruise control by mistake**

Switch the cruise control off using the “ON-OFF” button when not in use.

■ **Situations unsuitable for cruise control**

Do not use cruise control in any of the following situations. Doing so may result in loss of control and could cause an accident resulting in death or serious injury.

- In heavy traffic
- On roads with sharp bends
- On winding roads
- On slippery roads, such as those covered with rain, ice or snow
- On steep hills
Vehicle speed may exceed the set speed when driving down a steep hill.
- When your vehicle is towing a trailer

2-4. Using other driving systems

Speed limiter*

The desired maximum speed can be set using the cruise control switch. The speed limiter prevents vehicle speed from exceeding the set speed.

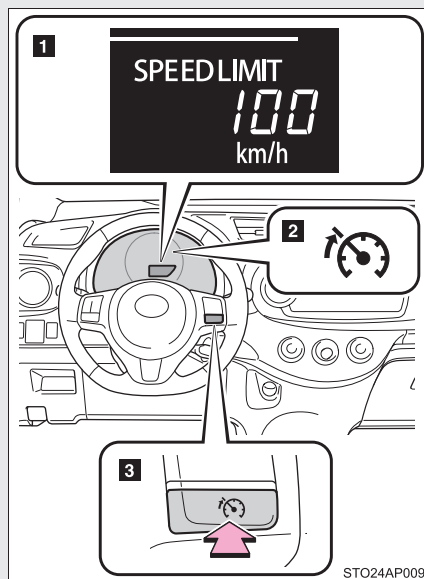

- 1 Display
- 2 Indicator
- 3 Speed limiter switch

■ Setting the vehicle speed

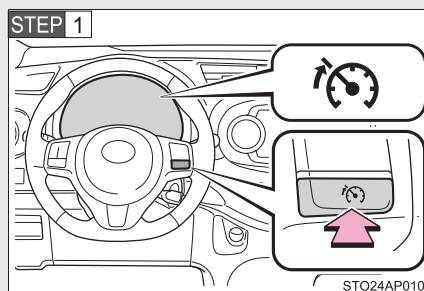

Press the speed limiter switch to activate the speed limiter.

Speed limiter indicator will come on.

Press the switch again to deactivate the speed limiter.

*: If equipped

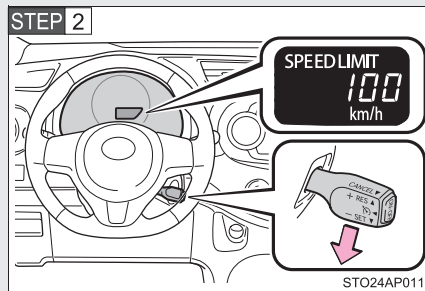

Accelerate or decelerate the vehicle to the desired speed, and push the lever down to set the speed.

The vehicle speed at the moment the lever is released becomes the set speed.

■ Adjusting the set speed

To change the set speed, operate the lever until the desired set speed is obtained.

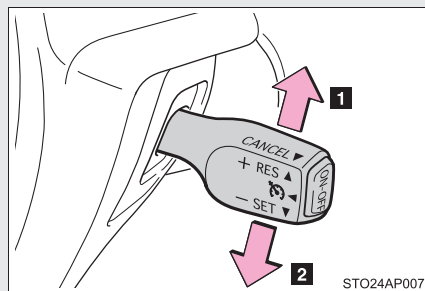

- 1 Increases the speed
- 2 Decreases the speed

Fine adjustment: Momentarily move the lever in the desired direction.

Large adjustment: Hold the lever in the desired direction.

Fine adjustment: By approximately 1 km/h (0.6 mph) each time the lever is operated

Large adjustment: By approximately 5 km/h (3.1 mph) for each 0.75 seconds the lever is held

■ Cancelling and resuming the speed limiter

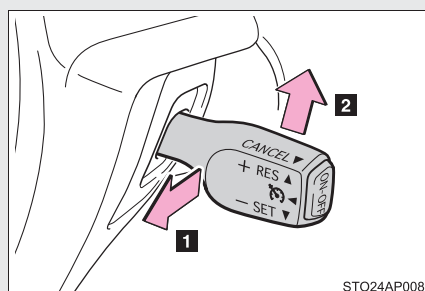

- 1 Pulling the lever toward you cancels the speed limiter.
- 2 Pushing the lever up resumes the speed limiter.

■ **Speed limiter can be set when**

The speed limiter can be set at any vehicle speed. However, if the speed limiter is set while the vehicle speed is below 30 km/h (18 mph), the speed limiter will be set to 30 km/h (18 mph).

■ **Exceeding the set speed**

In the following situation, the vehicle speed exceeds the set speed and multi-information display characters will flash:

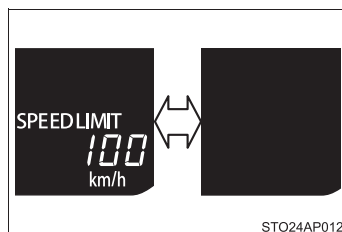

- When fully depressing the accelerator pedal
- When driving down a hill way

■ **Automatic speed limiter cancellation**

The set speed is automatically canceled when the cruise control is activated.

⚠ CAUTION

■ **To avoid operating the speed limiter by mistake**

Switch the speed limiter off using the speed limiter switch when not in use.

■ **Situations unsuitable for the speed limiter**

Do not use the speed limiter in either of the following situations. Doing so may result in loss of control and could cause a serious or fatal accident.

- On slippery roads, such as those covered with rain, ice and snow
- On steep hills
- When your vehicle is towing a trailer

2-4. Using other driving systems

Stop & Start system*

Vehicles with a Multidrive:

The Stop & Start system stops and restarts the engine according to the brake pedal and shift lever operation for stopping and starting the vehicle.

Vehicles with a manual transmission:

The Stop & Start system stops and restarts the engine according to the clutch pedal operation for stopping and starting the vehicle.

■ Stopping the engine

Vehicles with a Multidrive

STEP 1 While driving in D or M, depress the brake pedal fully, and stop the vehicle.

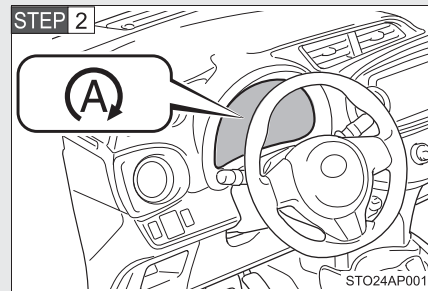

The engine will stop and the Stop & Start indicator will come on.

When the shift lever is in N or P, the engine will remain stopped without depressing the brake pedal.

Vehicles with a manual transmission

STEP 1 With the clutch pedal fully depressed, stop the vehicle. Then shift the shift lever to N.

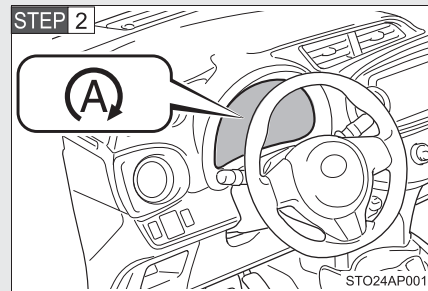

Release the clutch pedal.

The engine will stop and the Stop & Start indicator will come on.

*: If equipped

2

When driving

■ Restarting the engine

Vehicles with a Multidrive

Release the brake pedal. When the shift lever is in N or P, depress brake pedal and shift the shift lever to D or M.

The engine will restart. The Stop & Start indicator will go off.

Vehicles with a manual transmission

Check that the shift lever is in N and depress the clutch pedal.

The engine will restart. The Stop & Start indicator will go off. (In this situation, releasing the clutch pedal will not stop the engine again.)

Disabling the Stop & Start system

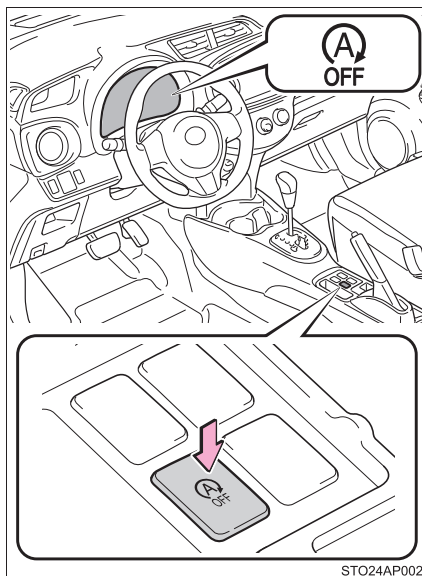

Press the Stop & Start cancel switch to disable the Stop & Start system.

The stop & start cancel indicator will come on.

The engine will not stop at each stop when the brake pedal (vehicles with a Multidrive) or clutch pedal (vehicles with a manual transmission) is depressed to stop the engine (→P. 235).

Pressing the switch again to re-enable the Stop & Start system.

■ If the Stop & Start cancel switch is pressed while the vehicle is stopped

- When the engine is stopped by the Stop & Start system, pressing the Stop & Start cancel switch will restart the engine. From the next time the vehicle is stopped (after Stop & Start system has been turned off), the engine will not be stopped.
- With the Stop & Start system disabled, pressing the Stop & Start cancel switch will re-enable the system but not stop the engine. From the next time the vehicle is stopped (after Stop & Start system has been turned on), the engine will be stopped.

■ Operating conditions

- The Stop & Start system is operational when all of the following conditions are met:
 - The engine is adequately warmed up.
 - The battery is sufficiently charged.
 - The driver's door is closed.
 - Vehicles with a Multidrive: The driver's seat belt is fastened.
 - The hood is closed.
 - The accelerator pedal is not being depressed.
 - The shift lever is not in R.
- In the following circumstances the engine may not be stopped by the Stop & Start system. This is not a malfunction of the Stop & Start system.
 - Engine coolant temperature or transmission fluid temperature is too low or too high.
 - The air conditioning system is being used when the vehicle interior temperature is extremely high such as after the vehicle was parked under the hot sun.
 - Vehicles with an automatic air conditioning system only: The windshield defogger is being used.
 - The battery is not sufficiently charged, or is undergoing a periodic recharge.
 - Due to traffic or other circumstances the vehicle is stopped repeatedly, resulting in the amount of time the engine is stopped by the Stop & Start system to become excessively high.
 - The brake pedal is not depressed firmly.

2-4. Using other driving systems

- The vehicle is stopped on a steep hill.
- The brake booster vacuum is low.
- A large amount of electricity is being used.
- At high altitude.

When the above conditions improve, the Stop & Start system will stop and restart the engine from the next time the vehicle is stopped.

● In the following situations, the engine may start even without the brake pedal being released (vehicles with a Multidrive) or clutch pedal being depressed (vehicles with a manual transmission).

- The brake pedal is pumped or strongly depressed.
- The air conditioning system is being used or turned on.
- Vehicles with an automatic air conditioning system only: The windshield defogger is turned on.
- The battery is not sufficiently charged.
- The vehicle starts to roll on an incline.
- Vehicles with a Multidrive: The hood is opened when the shift lever is in N or P.
- The accelerator pedal is depressed.
- A large amount of electricity is being used.
- Vehicles with a Multidrive: The driver's door is opened.
- Vehicles with a Multidrive: The driver's seat belt is unfastened.

● In the following situations, it may take longer than normal for the Stop & Start system to activate.

- The battery is discharged.
- After the battery terminals have been disconnected and reconnected after a battery replacement, etc.
- The engine coolant temperature is low.

■ Automatic reactivation of the Stop & Start system

Vehicles without a smart entry & start system:

Even if the Stop & Start system is disabled by the Stop & Start cancel switch, it will be automatically re-enabled once the engine switch is turned to the "LOCK" position then to the "START" position.

Vehicles with a smart entry & start system:

Even if the Stop & Start system is disabled by the Stop & Start cancel switch, it will be automatically re-enabled once the "ENGINE START STOP" switch is turned off then the engine is started.

■ The Stop & Start system protection feature

Vehicles without a smart entry & start system:

When an excessively loud sound is being projected by the audio system, the audio system may be automatically cut off in order to maintain power for the Stop & Start system function.

If this occurs, turning the engine switch to the "LOCK" position then to the "ACC" or "ON" position re-enables the audio system.

Vehicles with a smart entry & start system:

When an excessively loud sound is being projected by the audio system, the audio system may be automatically cut off in order to maintain power for the Stop & Start system function.

If this occurs, turning the "ENGINE START STOP" switch off then to ACCESSORY mode or IGNITION ON mode re-enables the audio system.

■ Steering wheel operation

When the engine is stopped by the Stop & Start system, the steering wheel may become heavier than when driving.

■ Hood

If the hood is opened while the engine is stopped by the Stop & Start system, the engine cannot be restarted by the Stop & Start system or by the automatic engine start function. Restart the engine with the engine switch operation. (→P. 165, 169)

Vehicles with a Multidrive: If the hood is opened while the engine is stopped by the Stop & Start system and the shift lever is in N or P, the engine will restart.

■ Hill-start assist control (vehicles with a Multidrive)

- On a steep uphill grade, the vehicle may roll backward after hill-start assist control is released. In this situation, apply the parking brake and operate the brake pedal when putting the vehicle in motion.
- This system operates on flat surfaces as well as steep grades.
- When the engine is stopped due to Stop & Start system operation, the force required to depress the brake pedal may change, but this is not a malfunction.

■ When to use the Stop & Start system

Use the Stop & Start system when stopping the vehicle temporarily at red lights, intersections, etc. When stopping the vehicle for a longer period of time, turn off the engine completely.

■ **Stop & Start system warning buzzer**



If the engine is stopped by the Stop & Start system and either of the following actions is performed, a buzzer will sound and the Stop & Start indicator will flash (vehicles with a Multidrive), or a buzzer will sound (vehicles with a manual transmission). This indicates that the engine is only stopped by the Stop & Start system, not that the engine has been turned off completely.

- Vehicles with a Multidrive: The driver's door is opened when the shift lever is in D or M.
- Vehicles with a Multidrive: The shift lever is shifted into a position other than N or P with the brake pedal released.
- Vehicles with a manual transmission: The shift lever is shifted into a position other than N with the clutch pedal released.

■ **If the Stop & Start cancel indicator light continues to flash**

The Stop & Start system may be malfunctioning. Contact any authorized Toyota dealer or repairer, or another duly qualified and equipped professional.

■ **If the windshield is fogged up while the engine is stopped by the Stop & Start system**

- Vehicles with an automatic air conditioning system
Turn the windshield defogger on. (The engine will start due to the automatic engine start function.) (→P. 277)
- Vehicles with a manual air conditioning system
 - Vehicles with a Multidrive: Restart the engine by releasing the brake pedal (when the shift lever is in D or M) or depress the brake pedal and shift the shift lever to D or M (when the shift lever is in N or P) (→P. 236), or by pressing the Stop & Start cancel switch, and then set the air outlet selection dial to . (→P. 269)
 - Vehicles with a manual transmission: Restart the engine by depressing the clutch pedal (→P. 236), or by pressing the Stop & Start cancel switch, and then set the air outlet selection dial to . (→P. 269)If the windshield fogs up frequently, press the Stop & Start cancel switch to deactivate the system.

■ **The Stop & Start system operation time and Stop & Start system total operation time display**

→P. 211

■ Replacing battery

The installed battery is specific to the Stop & Start system. It should only be replaced with a battery of identical type and rating.

Ask any authorized Toyota dealer or repairer, or another duly qualified and equipped professional for further details.

⚠ CAUTION**■ When the Stop & Start system is operating**

- Keep the shift lever in N and apply the brake pedal or parking brake for safety while the engine is stopped due to the Stop & Start system (while the Stop & Start indicator is on).
Unexpected accidents may occur due to the automatic engine start function.
- Do not leave the vehicle while the engine is stopped due to the Stop & Start system (while the Stop & Start indicator is on).
Unexpected accidents may occur due to the automatic engine start function.
- Ensure that the engine is not stopped by the Stop & Start system while the vehicle is in a poorly ventilated area. The engine may restart due to the automatic engine start function, causing exhaust gases to collect and enter the vehicle and resulting in death or a serious health hazard.

 NOTICE

■ **To ensure the system operates correctly**

If any one of the following situations occurs, the Stop & Start system may not operate correctly, thus, please have your vehicle checked by any authorized Toyota dealer or repairer, or another duly qualified and equipped professional.

- While the driver's seat belt is fastened, the driver's and front passenger's seat belt reminder light flashes.
- Even when the driver's seat belt is not fastened, the driver's and front passenger's seat belt reminder light remains off.
- Even when the driver's door is closed, the open door warning light comes on, or the interior light comes on when the interior light switch is in the door position.
- Even when the driver's door is opened, the open door warning light does not come on, or the interior light does not come on when the interior light switch is in the door position.

2-4. Using other driving systems

Driving assist systems

To help enhance driving safety and performance, the following systems operate automatically in response to various driving situations. Be aware, however, that these systems are supplementary and should not be relied upon too heavily when operating the vehicle.

■ **ABS (Anti-lock Brake System)**

Helps to prevent wheel lock when the brakes are applied suddenly, or if the brakes are applied while driving on a slippery road surface

■ **Brake assist**

Generates an increased level of braking force after the brake pedal is depressed when the system detects a panic stop situation

■ **VSC (Vehicle Stability Control) (if equipped)**

Helps the driver to control skidding when swerving suddenly or turning on slippery road surfaces

■ **TRC (Traction Control) (if equipped)**

Helps to maintain drive power and prevent the drive wheels from spinning when starting the vehicle or accelerating on slippery roads

■ **Hill-start assist control (with Stop & Start system and Multi-drive)**

Helps to prevent the vehicle from rolling backwards when the brake pedal is released to restart the engine

■ **EPS (Electric Power Steering)**

Employs an electric motor to reduce the amount of effort needed to turn the steering wheel

When the VSC/TRC systems are operating

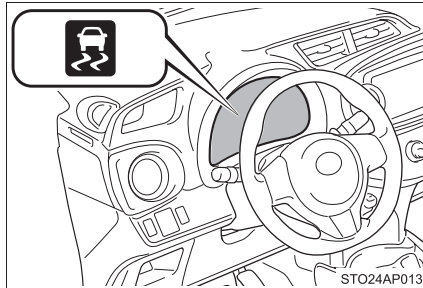

The slip indicator light flashes to indicate that the VSC/TRC systems have been engaged.

Disabling the TRC/VSC systems

If the vehicle gets stuck in fresh snow or mud, the TRC/VSC systems may reduce power from the engine to the wheels. You may need to turn the system off to enable you to rock the vehicle in order to free it.

■ Turning off the TRC system only

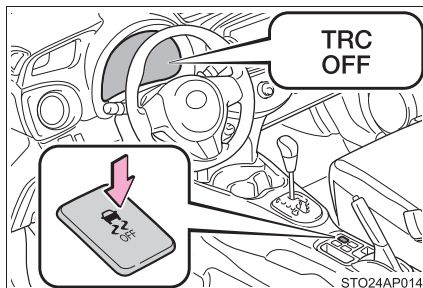

To turn the TRC system off, quickly press and release the button.

The "TRC OFF" indicator light will come on.

Press the button again to turn the system back on.

■ Turning off both TRC and VSC systems

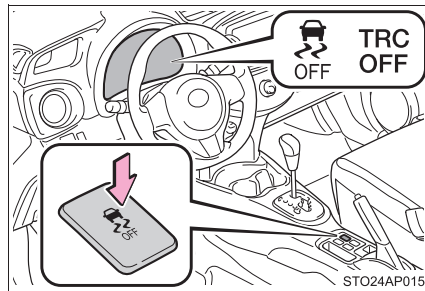

To turn the TRC and VSC systems off, press and hold the button for more than 3 seconds while the vehicle is stopped.

The “TRC OFF” indicator light and VSC OFF indicator light will come on.

Press the button again to turn the systems back on.

2

When driving

■ Hill-start assist control operation conditions

- The shift lever is in D or M.
- The brake pedal is not depressed.

■ Sounds and vibrations caused by the ABS, brake assist, VSC, TRC and hill-start assist control systems

- A sound may be heard from the engine compartment when the engine is started or just after the vehicle begins to move. This sound does not indicate that a malfunction has occurred in any of these systems.
- Any of the following conditions may occur when the above systems are operating. None of these indicates that a malfunction has occurred.
 - Vibrations may be felt through the vehicle body and steering.
 - A motor sound may be heard after the vehicle comes to a stop.
 - The brake pedal may pulsate slightly after the ABS is activated.
 - The brake pedal may move down slightly after the ABS is activated.

■ EPS operation sound

When the steering wheel is operated, a motor sound (whirring sound) may be heard. This does not indicate a malfunction.

■ Reactivation of the TRC/VSC systems after turning off the engine

If the TRC/VSC systems are turned off, re-starting the engine will automatically reactivate them.

■ **Reactivation of the TRC system linked to vehicle speed**

When only the TRC system is turned off, the TRC system will turn on when vehicle speed increases. However, when both TRC and VSC systems are turned off, the systems will not turn on even when vehicle speed increases.

■ **Reduced effectiveness of the EPS system**

The effectiveness of the EPS system is reduced to prevent the system from overheating when there is frequent steering input over an extended period of time. The steering wheel may feel heavy as a result. Should this occur, refrain from excessive steering input or stop the vehicle and turn the engine off. The EPS system should return to normal within 10 minutes.

■ **If the slip indicator comes on...**

It may indicate a malfunction in the driving assist systems. Contact any authorized Toyota dealer or repairer, or another duly qualified and equipped professional.

 **CAUTION**

■ **The ABS does not operate effectively when**

- Tires with inadequate gripping ability are used (such as excessively worn tires on a snow covered road).
- The vehicle hydroplanes while driving at high speed on wet or slick roads.

■ **Stopping distance when the ABS is operating may exceed that of normal conditions**

The ABS is not designed to shorten the vehicle's stopping distance. Always maintain a safe distance from the vehicle in front of you in the following situations:

- When driving on dirt, gravel or snow-covered roads
- When driving with tire chains
- When driving over bumps in the road
- When driving over roads with potholes or roads with uneven surfaces

⚠ CAUTION**■ TRC may not operate effectively when**

Directional control and power may not be achievable while driving on slippery road surfaces, even if the TRC system is operating.
Do not drive the vehicle in conditions where stability and power may be lost.

■ Hill-start assist control does not operate effectively when

Do not overly rely on the hill-start assist control. The hill-start assist control may not operate effectively on steep inclines and roads covered with ice.

■ When the VSC is activated

The slip indicator light flashes. Always drive carefully. Reckless driving may cause an accident. Exercise particular care when the indicator light flashes.

■ When the TRC/VSC systems are turned off

Be especially careful and drive at a speed appropriate to the road conditions. Do not turn the TRC/VSC systems off unless necessary, as these are the systems to ensure vehicle stability and driving force by automatically controlling braking and engine outputs.

■ Replacing tires

Observe the following precautions.
Failure to do so may cause the ABS, VSC and TRC systems not to function correctly.

- Make sure that all tires are of the specified size, brand, tread pattern and total load capacity.
- Do not use tires of noticeably different wear level.
- Make sure that the tires are inflated to the recommended tire inflation pressure level. (→P. 533)

Contact any authorized Toyota dealer or repairer, or another duly qualified and equipped professional for further information when replacing tires or wheels.

■ Handling of tires and the suspension

Using tires with any kind of problem or modifying the suspension will affect the driving assist systems, and may cause a system to malfunction.

2-4. Using other driving systems

Diesel particulate filter system*

When the deposit collected by the filter reaches a predetermined amount, it is automatically cleaned.

■ Cleaning the DPF catalytic converter

Cleaning the DPF catalytic converter is performed as necessary in accordance with driving conditions.

■ Equipment characteristics

The DPF system has the following characteristics:

- Idle speed increases during cleaning
- The smell of the exhaust gas changes
- When starting the engine, white-colored steam (water vapor) may be expelled during cleaning
- Acceleration performance may degrade during cleaning

■ Replacing the engine oil

→P. 376

*: If equipped

 CAUTION

■ **Exhaust pipe**

Do not touch the exhaust pipe during cleaning, as the exhaust pipe and exhaust gases will become particularly hot. Also, make sure that there are no people or flammable materials near the exhaust pipe while the vehicle is stopped.

Failure to do so may cause injury by burning or a fire.

 NOTICE

■ **To prevent the DPF system from failing**

- Do not use fuel other than the specified type
- Do not use engine oil other than the recommended type
- Do not modify the exhaust pipe

2

When driving

2-5. Driving information

Cargo and luggage

Take notice of the following information about storage precautions, cargo capacity and load:

- Stow cargo and luggage in the luggage compartment whenever possible.
- Be sure all items are secured in place.
- To maintain vehicle balance while driving, position luggage evenly within the luggage compartment.
- For better fuel economy, do not carry unnecessary weight.

CAUTION

■ Things that must not be carried in the luggage compartment

The following things may cause a fire if loaded in the luggage compartment:

- Receptacles containing gasoline
- Aerosol cans

■ Storage precautions

Observe the following precautions.

Failure to do so may result in death or serious injury.

- Stow cargo and luggage in the luggage compartment whenever possible.
- Do not stack anything in the luggage compartment higher than the seat-backs.
Such items may be thrown about and possibly injure people in the vehicle in the event of sudden braking or in an accident.
- Do not place cargo or luggage in or on the following locations as the item may get under the clutch, brake or accelerator pedal and prevent the pedals from being depressed properly, block the driver's vision, or hit the driver or passengers, causing an accident:
 - At the feet of the driver
 - On the front passenger or rear seats (when stacking items)
 - On the luggage cover
 - On the instrument panel
 - On the dashboard

 CAUTION

- Secure all items in the occupant compartment, as they may shift and injure someone during sudden braking, sudden swerving or an accident.
 - Vehicles with a rear seat: When you fold down the rear seats, long items should not be placed directly behind the front seats.
 - Never allow anyone to ride in the luggage compartment. It is not designed for passengers. They should ride in their seats with their seat belts properly fastened. Otherwise, they are much more likely to suffer death or serious bodily injury, in the event of sudden braking, sudden swerving or an accident.
- **Load and distribution**
- Do not overload your vehicle.
 - Do not apply loads unevenly.
Improper loading may cause deterioration of steering or braking control which may cause death or serious injury.

2-5. Driving information

Winter driving tips

Carry out the necessary preparations and inspections before driving the vehicle in winter. Always drive the vehicle in a manner appropriate to the prevailing weather conditions.

■ Pre-winter preparations

- Use fluids that are appropriate to the prevailing outside temperatures.
 - Engine oil
 - Engine coolant
 - Washer fluid
- Have a service technician inspect the level and specific gravity of battery electrolyte.
- Have the vehicle fitted with four snow tires or purchase a set of tire chains for the front tires.

Ensure that all tires are the same size and brand, and that their wear level is not noticeably different with each other. Also make sure that chains match the size of the tires.

■ Before driving the vehicle

Perform the following according to the driving conditions:

- Do not try to forcibly open a window or move a wiper that is frozen. Pour warm water over the frozen area to melt the ice. Wipe away the water immediately to prevent it from freezing.
- To ensure proper operation of the climate control system fan, remove any snow that has accumulated on the air inlet vents in front of the windshield.
- Remove any ice that has accumulated on the vehicle chassis.
- Periodically check for and remove any excess ice or snow that may have accumulated in the wheel well or on the brakes.

■ When driving the vehicle

Accelerate the vehicle slowly and drive at a reduced speed suitable to the road conditions.

■ When parking the vehicle (in the winter time or in the cold latitudes)

Park the vehicle and move the shift lever to P (vehicles with a Multidrive), E, M or R (vehicles with a multi-mode manual transmission), and 1 or R (vehicles with a manual transmission) without setting the parking brake. The parking brake may freeze up, preventing it from being released. If necessary, block the wheels to prevent inadvertent sliding or creeping.

2

When driving

Selecting tire chains

Use the correct tire chain size when mounting the tire chains. Chain size is regulated for each tire size.

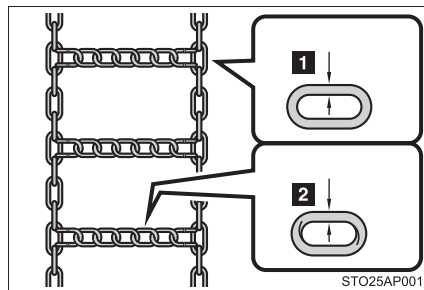

1 Side chain

Except 175/65R14 tires: 3 mm (0.12 in.) in diameter

175/65R14 tires: 4 mm (0.16 in.) in diameter

2 Cross chain

Except 175/65R14 tires: 4 mm (0.16 in.) in diameter

175/65R14 tires: 5 mm (0.20 in.) in diameter

Regulations on the use of tire chains

Regulations regarding the use of tire chains vary depending on location and type of road. Always check local regulations before installing chains.

■ Tire chain installation

Observe the following precautions when installing and removing chains:

- Install and remove tire chains in a safe location.
- Install tire chains on the front tires only. Do not install tire chains on the rear tires.
- Install tire chains on front tires as tightly as possible. Retighten chains after driving 0.5 — 1.0 km (1/4 — 1/2 mile).
- Install tire chains following the instructions provided with the tire chains.
- If wheel ornaments are used, they will be scratched by the chain band, so remove the ornaments before putting on the chains. (→P. 462)

 CAUTION**■ Driving with snow tires**

Observe the following precautions to reduce the risk of accidents. Failure to do so may result in a loss of vehicle control and cause death or serious injury.

- Use tires of the specified size.
- Maintain the recommended level of air pressure.
- Do not drive at speeds in excess of the speed limit or the speed limit specified for the snow tires being used.
- Use snow tires on all, not just some wheels.
- Do not use tires of noticeably different wear level.

■ Driving with tire chains

Observe the following precautions to reduce the risk of accidents. Failure to do so may result in the vehicle being unable to be driven safely, and may cause death or serious injury.

- Do not drive in excess of the speed limit specified for the tire chains being used, or 50 km/h (30 mph), whichever is lower.
- Avoid driving on bumpy road surfaces or over potholes.
- Avoid sudden turns and braking, as use of chains may adversely affect vehicle handling.
- Slow down sufficiently before entering a curve to ensure that vehicle control is maintained.

2-5. Driving information

Trailer towing (except for South Africa)

Your vehicle is designed primarily as a passenger carrying vehicle. Towing a trailer will have an adverse effect on handling, performance, braking, durability, and fuel consumption. Your safety and satisfaction depend on the proper use of correct equipment and cautious driving habits. For your safety and the safety of others, do not overload the vehicle or trailer.

To tow a trailer safely, use extreme care and drive the vehicle in accordance with the trailer's characteristics and operating conditions.

Toyota warranties do not apply to damage or malfunction caused by towing a trailer for commercial purposes.

Ask your local authorized Toyota dealer or repairer, or another duly qualified and equipped professional, for further details before towing, as there are additional legal requirements in some countries.

■ Weight limits

Check the allowable towing capacity, GVM (Gross Vehicle Mass), MPAC (Maximum Permissible Axle Capacity), and permissible drawbar load before towing. (→P. 518)

■ Towing hitch/bracket

Toyota recommends the use of the Toyota hitch/bracket for your vehicle. Other products of a suitable nature and comparable quality may also be used.

Important points regarding trailer loads

■ Total trailer weight and permissible drawbar load

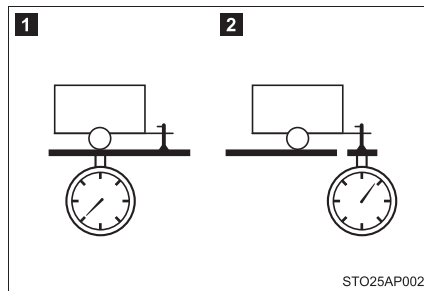

1 Total trailer weight

Weight of the trailer itself plus the trailer load should be within the maximum towing capacity. Exceeding this weight is dangerous. (→P. 518)

When towing a trailer, use a friction coupler or friction stabilizer (sway control device).

2 Permissible drawbar load

Allocate the trailer load so that the drawbar load is greater than 25 kg (55.1 lb.) or 4% of the towing capacity. Do not let the drawbar load exceed the indicated weight. (→P. 518)

2

When driving

■ Information tag (manufacturer's label)

Type A

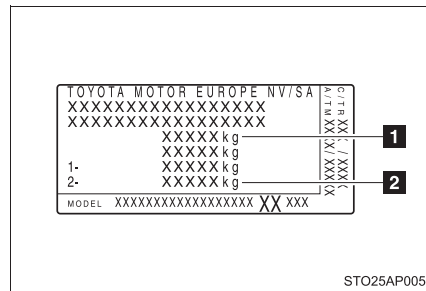

- 1 Gross vehicle mass
- 2 Maximum permissible rear axle capacity

Type B

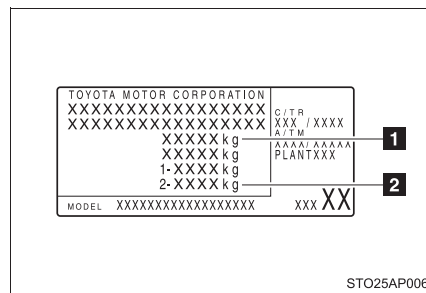

- 1 Gross vehicle mass
- 2 Maximum permissible rear axle capacity

■ Gross vehicle mass

Vehicle category M1 models*:

The combined weight of the driver, passengers, luggage, towing hitch, total curb mass and drawbar load should not exceed the gross vehicle mass by more than 100 kg (220.5 lb.). Exceeding this weight is dangerous.

Vehicle category N1 models*:

The combined weight of the driver, passengers, cargo, towing hitch, total curb mass and drawbar load must not exceed the gross vehicle mass. Exceeding this weight is dangerous.

■ Maximum permissible rear axle capacity

Vehicle category M1 models*:

The weight borne by the rear axle should not exceed the maximum permissible rear axle capacity by 15% or more. Exceeding this weight is dangerous.

Vehicle category N1 models*:

The weight borne by the rear axle should not exceed the maximum permissible rear axle capacity. Exceeding this weight is dangerous.

The values for towing capacity were derived from testing conducted at sea level. Take note that engine output and towing capacity will be reduced at high altitudes.

CAUTION

■ When the gross vehicle mass limit or maximum permissible axle capacity is exceeded (vehicle category M1 models*)

Do not exceed the established speed limit for towing a trailer in built-up areas or 100 km/h (62 mph), whichever is lower.

Failing to observe this precaution may lead to an accident causing death or serious injury.

*: To distinguish the vehicle category, ask any authorized Toyota dealer or repairer, or another duly qualified and equipped professional.

Installation positions* for the towing hitch/bracket and hitch ball

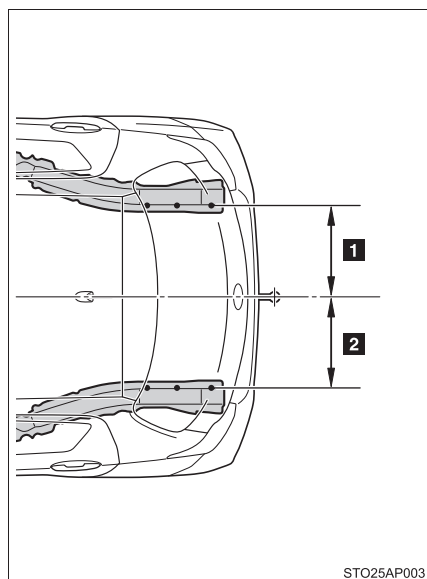

1 434 mm (17.1 in.)

2 434 mm (17.1 in.)

*: Gross vehicle mass and standard tire size
To distinguish the vehicle category, ask any authorized Toyota dealer or
repaier, or another duly qualified and equipped professional.

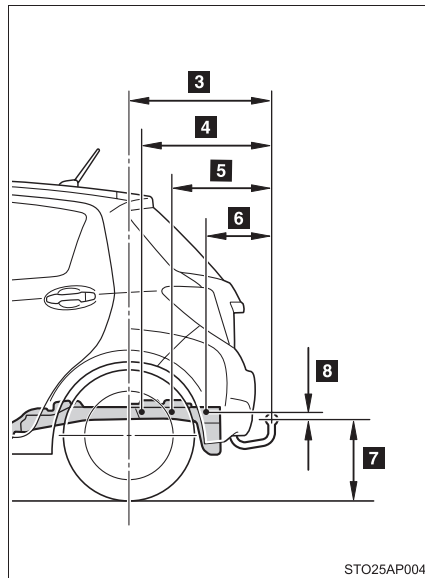

- 3** 655 mm (25.8 in.)
- 4** 602 mm (23.7 in.)
- 5** 468 mm (18.4 in.)
- 6** 313 mm (12.3 in.)
- 7** 397 mm (15.6 in.)
- 8** 26.2 mm (1.0 in.)

2

When driving

■ **Tire information**

- Ensure that your vehicle's tires are properly inflated. Adjust the tire pressure to the recommended pressure. (→P. 533)
- Increase the air pressure of the trailer tires in accordance with the total trailer weight and according to the values recommended by the manufacturer of your trailer.

■ **Trailer lights**

Check that the turn signal lights and stoplights are operating correctly every time you hitch up the trailer. Directly wiring up to your vehicle may damage the electrical system and stop the lights from functioning correctly.

■ **Break-in schedule**

Toyota recommends that vehicles fitted with new power train components should not be used for towing trailers for the first 800 km (500 miles).

■ **Safety checks before towing**

- Check that the maximum load limit for the towing hitch/bracket and hitch ball is not exceeded. Bear in mind that the coupling weight of the trailer will add to the load exerted on the vehicle. Also make sure that the total load exerted on the vehicle is within the range of the weight limits. (→P. 257)
- Ensure that the trailer load is secure.
- Supplementary outside rear view mirrors should be added to the vehicle if the traffic behind cannot be clearly seen with standard mirrors. Adjust the extending arms of these mirrors on both sides of the vehicle so that they always provide maximum visibility of the road behind.

■ **Maintenance**

- Maintenance must be performed more frequently when using the vehicle for towing due to the greater weight burden placed on the vehicle compared to normal driving.
- Retighten all bolts securing the hitching ball and bracket after towing for approximately 1000 km (600 miles).

 NOTICE**■ When the rear bumper strengthening material is aluminum**

Ensure the steel bracket part does not come directly in contact with that area.

When steel and aluminum come into contact, there is a reaction similar to corrosion, which will weaken the section concerned and may result in damage. Apply a rust inhibitor to parts that will come in contact when attaching a steel bracket.

Guidance

Your vehicle will handle differently when towing a trailer. In order to avoid accident, death or serious injury, keep the following in mind when towing:

■ Checking connections between trailer and lights

Stop the vehicle and check the operation of the connection between the trailer and lights after driving for a brief period as well as before starting off.

■ Practicing driving with a coupled trailer

- Get the feel for turning, stopping and reversing with the trailer coupled by practicing in an area with no or light traffic.
- When reversing with a coupled trailer, hold the section of the steering wheel nearest to you and rotate clockwise to turn the trailer left or counterclockwise to turn it right. Always rotate a little at a time to prevent steering error. Have someone guide you when reversing to lessen the risk of an accident.

■ **Increasing vehicle-to-vehicle distance**

At a speed of 10 km/h (6 mph), the distance to the vehicle running ahead of you should be equivalent to or greater than the combined length of your vehicle and trailer. Avoid sudden braking that may cause skidding. Otherwise, the vehicle may spin out of control. This is especially true when driving on wet or slippery road surfaces.

■ **Sudden acceleration/steering input/cornering**

Executing sharp turns when towing may result in the trailer colliding with your vehicle. Decelerate well in advance when approaching turns and take them slowly and carefully to avoid sudden braking.

■ **Important points regarding turning**

The wheels of the trailer will travel closer to the inside of the curve than the wheels of the vehicle. To make allowance for this, take the turns wider than you would normally do.

■ **Important points regarding stability**

Vehicle movement resulting from uneven road surfaces and strong crosswinds will affect handling. The vehicle may also be rocked by passing buses or large trucks. Frequently check behind when moving alongside such vehicles. As soon as such vehicle movement occurs, immediately start to decelerate smoothly by slowly applying the brakes. Always steer the vehicle straight ahead while braking.

■ **Passing other vehicles**

Consider the total combined length of your vehicle and trailer and ensure that the vehicle-to-vehicle distance is sufficient before executing lane changes.

■ Transmission information

Vehicles with a Multidrive and multi-mode manual transmission:

To maintain engine braking efficiency, when using engine braking, do not use the transmission in D. Transmission shift gear position must be in 4 in the M mode. (→P. 179, 185)

Vehicles with a manual transmission:

To maintain engine braking efficiency, when using engine braking, do not use the transmission in 5 and 6 (vehicles with a 6-speed manual transmission) gear. (→P. 190)

■ If the engine overheats

Towing a loaded trailer up a long, steep incline in temperatures exceeding 30°C (85°F) may result in the engine overheating. If the high engine coolant temperature warning light flashes or comes on, turn the air conditioning off immediately, leave the road and stop the vehicle in a safe place. (→P. 505)

■ When parking the vehicle

Always place wheel chocks under the wheels of both the vehicle and trailer. Firmly set the parking brake and shift the shift lever to P for Multidrives, E, M or R for multi-mode manual transmissions, and 1 or R for manual transmissions.

 CAUTION

Follow all the instructions described in this section. Failure to do so could cause an accident resulting in death or serious injury.

■ **Trailer towing precautions**

When towing, make sure that none of the weight limits are exceeded.
(→P. 257)

■ **Vehicle speed in towing**

Observe the legal maximum speeds for trailer towing.

■ **Before descending hills or long declines**

Reduce speed and downshift. However, never downshift suddenly while descending steep or long downhill grades.

■ **Operation of the brake pedal**

Do not hold the brake pedal depressed often or for long periods of time. Doing so may result in the brake overheating or reduce braking effects.

■ **To avoid accident or injury**

- Do not use cruise control when you are towing.
- Vehicles with a compact spare tire: Do not tow the vehicle with the compact spare tire installed.

3-1. Using the air conditioning system and defogger

Manual air conditioning system 268

Automatic air conditioning system 275

Power heater 283

Rear window and outside rear view mirror defoggers 285

3-2. Using the audio system

Audio system types 287

Using the radio 292

Using the CD player 296

Playing back MP3 and WMA discs..... 301

Operating an iPod..... 307

Operating a USB memory..... 315

Optimal use of the audio system 322

Using the AUX port..... 324

Using the steering wheel audio switches 325

3-3. Using the interior lights

Interior lights list..... 328

- Personal lights 329
- Interior light..... 329

3-4. Using the storage features

List of storage features 331

- Glove box 332
- Cup holders 333
- Bottle holders..... 334

3-5. Other interior features

Sun visors 336

Vanity mirrors..... 337

Clock..... 338

Outside temperature display 339

Portable ashtray..... 340

Cigarette lighter 341

Power outlet..... 342

Seat heaters 343

Armrest 345

Panoramic roof shade..... 346

Floor mat..... 347

Luggage compartment features..... 349

3-1. Using the air conditioning system and defogger Manual air conditioning system*

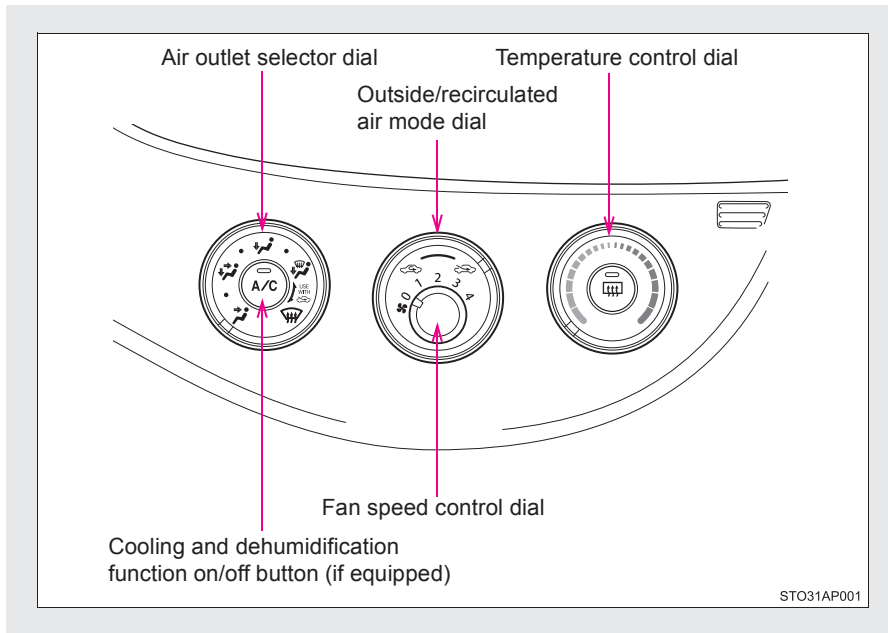

*: If equipped

Adjusting the settings

STEP 1 To adjust the fan speed, turn the fan speed control dial clockwise (increase) or counterclockwise (decrease).

Turning the dial to "0" turns off the fan.

STEP 2 Vehicles without a cooling and dehumidification function on/off button:

Turn the temperature control dial clockwise to increase the temperature.

Vehicles with a cooling and dehumidification function on/off button:

To adjust the temperature setting, turn the temperature control dial clockwise (warm) or counterclockwise (cool).

If  is not pressed, the system will blow ambient temperature air or heated air.

STEP 3 To select the air outlets, set the air outlet selector dial to the desired position.

The positions between the air outlet selectors shown below can also be selected for more delicate adjustment.

Defogging the windshield

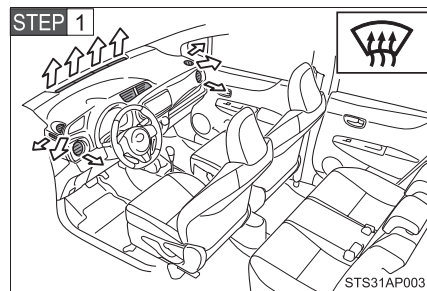

Set the air outlet selector dial to  position.

Set the outside/recirculated air mode dial to outside mode if recirculated air mode is used.

3-1. Using the air conditioning system and defogger

STEP 2 Perform the following operations accordingly:

- To adjust the fan speed, turn the fan speed control dial.
- To adjust the temperature setting, turn the temperature control dial.
- If the dehumidification function is not operating, press



to operate the dehumidification function.

To defog the windshield and the side windows early, turn the air flow and temperature up.

Air outlets and air flow

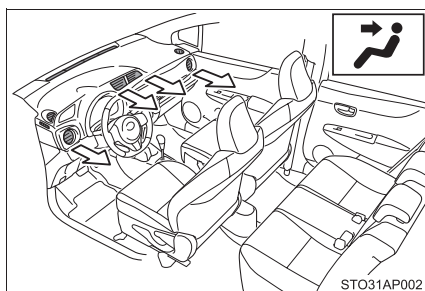

Air flows to the upper body.

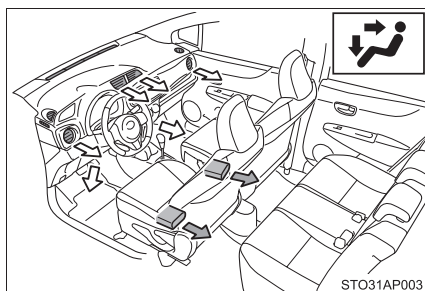

Air flows to the upper body and feet.

← : Some models

3-1. Using the air conditioning system and defogger

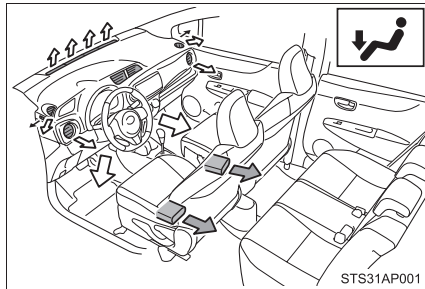

Air flows mainly to the feet.

← : Some models

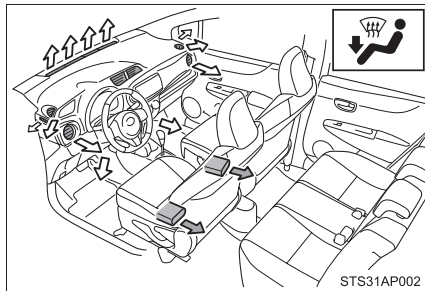



Air flows to the feet and the windshield defogger operates.

Use the outside/recirculated air mode dial at  (outside air mode).

← : Some models

Switching between outside air and recirculated air modes

Turn the outside/recirculated air mode dial to  (outside air mode) or  (recirculated air mode).

Adjusting the position of and opening and closing the air outlets

Center outlets

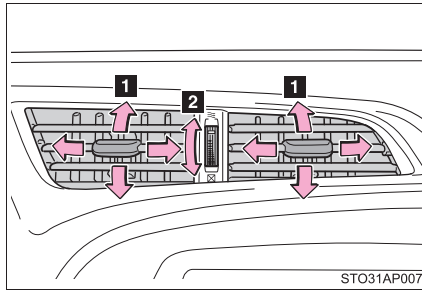

- 1 Direct air flow to the left or right, up or down.
- 2 Turn the knob to open or close the vent.

Right and left side outlets

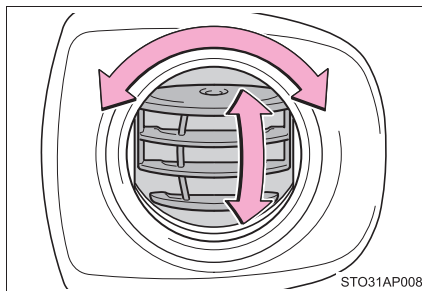

- Direct air flow to the left or right, up or down.

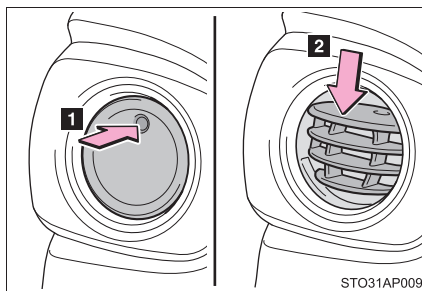

- 1 Open the vent.
- 2 Close the vent.

■ **Fogging up of the windows**

- The windows will easily fog up when the humidity in the vehicle is high.

Turning  on will dehumidify the air from the outlets and defog the windshield effectively.

- If you turn  off, the windows may fog up more easily.
- The windows may fog up if the recirculated air mode is used.

■ **Outside/recirculated air mode**

When driving on dusty roads such as tunnels or in heavy traffic, set the outside/recirculated air mode dial to the recirculated air mode. This is effective in preventing outside air from entering the vehicle interior. During cooling operation, setting the recirculated air mode will also cool the vehicle interior effectively.

■ **When the indicator light on  goes off by itself (vehicles with a cooling and dehumidification function on/off button)**

Press  to turn off the dehumidification function and turn it on again.

There may be a problem in the air conditioning system if the indicator light goes off again. Turn the air conditioning system off and have it inspected by any authorized Toyota dealer or repairer, or another duly qualified and equipped professional.

■ **When the outside temperature falls to nearly 0°C (32°F) (vehicles with a cooling and dehumidification function on/off button)**

The dehumidification function may not operate even when  is pressed.

3-1. Using the air conditioning system and defogger

■ Air conditioning odors

- During use, various odors from inside and outside the vehicle may enter into and accumulate in the air conditioning system. This may then cause odor to be emitted from the vents.
- To reduce potential odors from occurring:
It is recommended that the air conditioning system be set to outside air mode prior to turning the vehicle off.

■ An odor comes from the air conditioning system due to the Stop & Start system operation (vehicles with a Stop & Start system)

When the engine is stopped due to the Stop & Start system, an odor caused by moisture may be detected. This does not indicate a malfunction.

■ Air conditioning filter

→P. 398

CAUTION

■ To prevent the windshield from fogging up

Do not use  during cool air operation in extremely humid weather. The difference between the temperature of the outside air and that of the windshield can cause the outer surface of the windshield to fog up, blocking your vision.

NOTICE

■ To prevent battery discharge

Do not leave the air conditioning system on longer than necessary when the engine is stopped.

3-1. Using the air conditioning system and defogger Automatic air conditioning system*

Air outlets and fan speed are automatically adjusted according to the temperature setting.

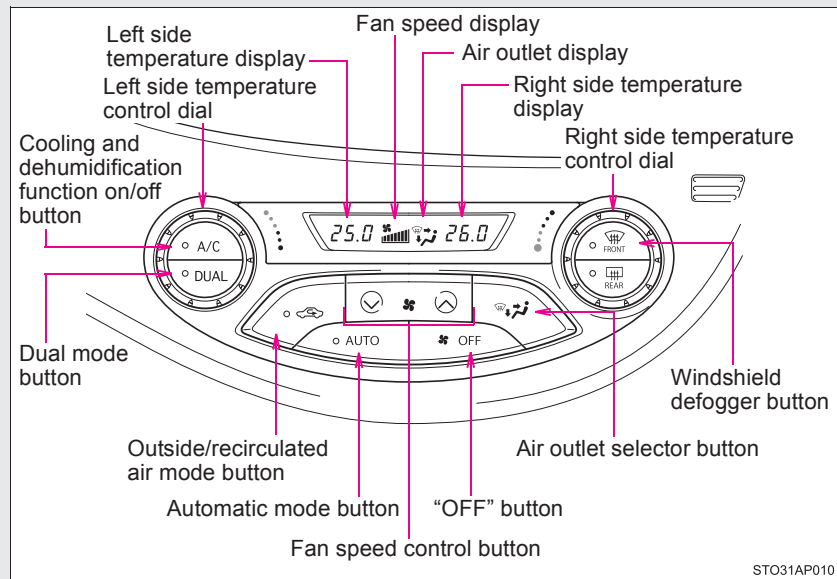

3

Interior features



Using the automatic mode



STEP 1 Press .

Air outlets and fan speed are automatically adjusted according to the temperature setting.

*: If equipped

3-1. Using the air conditioning system and defogger

STEP 2 Turn  clockwise to increase the temperature and turn  counterclockwise to decrease the temperature.

When  is pressed (the indicator on  is on) or  is turned, the temperature for the driver side and front passenger side can be adjusted separately.



STEP 3 Press .



The dehumidification function turns on and off each time  is pressed.

Adjusting the settings manually

STEP 1 To adjust the fan speed, press “^” on  to increase the fan speed and “v” to decrease the fan speed.

Press  to turn the fan off.

STEP 2 To adjust the temperature setting, turn  clockwise to increase the temperature and turn  counterclockwise to decrease the temperature.

When  is pressed (the indicator on  is on) or  is turned, the temperature for the driver side and front passenger side can be adjusted separately.

If  is not pressed, the system will blow ambient temperature air or heated air.

3-1. Using the air conditioning system and defogger

STEP 3 To change the air outlets, press .

The air outlets used are switched each time  is pressed.

Defogging the windshield

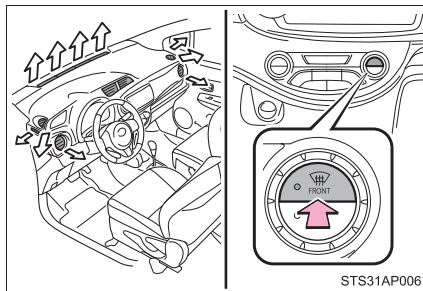

Press .

The dehumidification function operates and fan speed increases.

Set the outside/recirculated air mode button to the outside air mode if the recirculated air mode is used. (It may switch automatically.) To defog the windshield and the side windows early, turn the air flow and temperature up.

To return to the previous mode, press  again when the windshield is defogged.

Air outlets and air flow

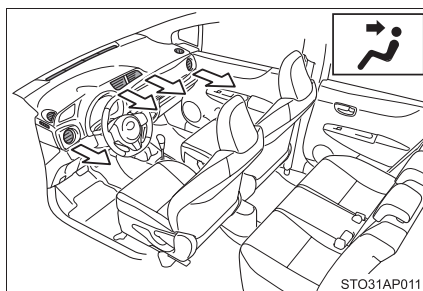

Air flows to the upper body.

3-1. Using the air conditioning system and defogger

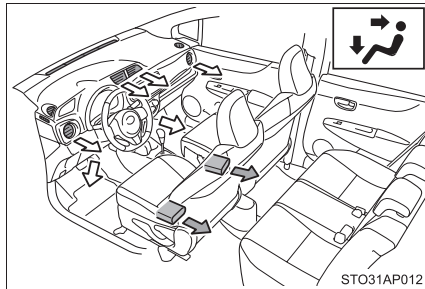

Air flows to the upper body and feet.

← : Some models

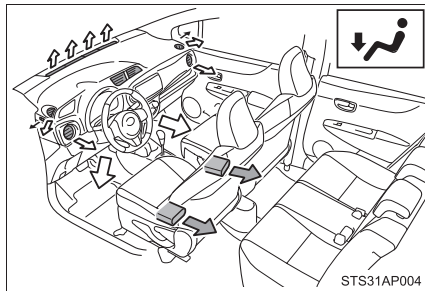

Air flows mainly to the feet.

← : Some models

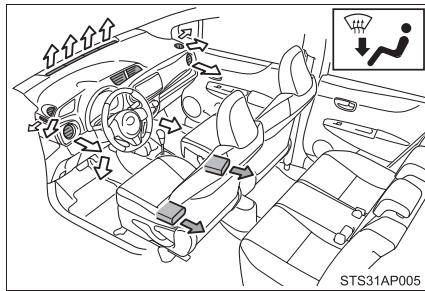

Air flows to the feet and the windshield defogger operates.

← : Some models

Switching between outside air and recirculated air modes

Press .

The mode switches between outside air mode (the indicator is off) and recirculated air mode (the indicator is on) each time the button is pressed.

Adjusting the position of and opening and closing the air outlets

Center outlets

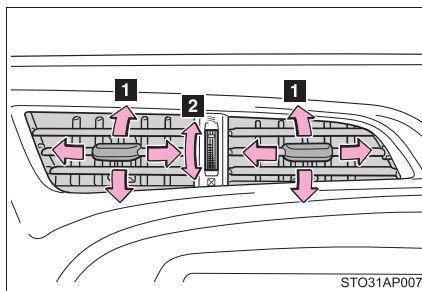

- 1 Direct air flow to the left or right, up or down.
- 2 Turn the knob to open or close the vent.

Right and left side outlets

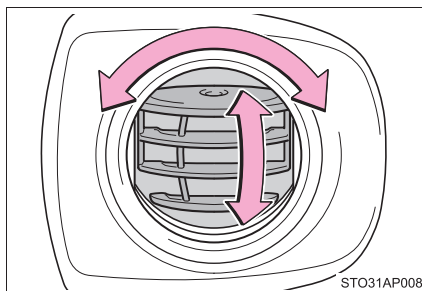

- Direct air flow to the left or right, up or down.

3-1. Using the air conditioning system and defogger

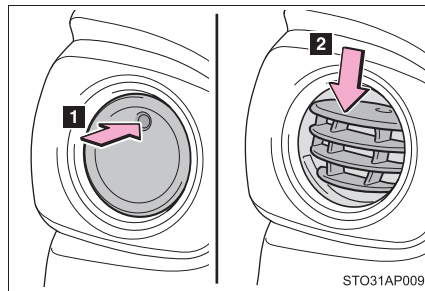

1 Open the vent.

2 Close the vent.

■ Using the automatic mode

Fan speed is adjusted automatically in accordance with the temperature setting and the ambient conditions.

Therefore, the fan may stop for a while until warm or cool air is ready to flow immediately after  is pressed.

■ Fogging up of the windows

- The windows will easily fog up when the humidity in the vehicle is high.

Turning  on will dehumidify the air from the outlets and defog the windshield effectively.

- If you turn  off, the windows may fog up more easily.
- The windows may fog up if the recirculated air mode is used.

■ Outside/recirculated air mode

- When driving on dusty roads such as tunnels or in heavy traffic, set the outside/recirculated air mode button to the recirculated air mode. This is effective in preventing outside air from entering the vehicle interior. During cooling operation, setting the recirculated air mode will also cool the vehicle interior effectively.
- Outside/recirculated air mode may automatically switch depending on the temperature setting or the inside temperature.

■ **When outside air temperature falls to nearly 0°C (32°F)**

The dehumidification function may not operate even when  is pressed.

■ **When the indicator light on  goes off by itself**

Press  to turn off the dehumidification function and turn it on again.

There may be a problem in the air conditioning system if the indicator light goes off again. Turn the air conditioning system off and have it inspected by any authorized Toyota dealer or repairer, or another duly qualified and equipped professional.

■ **Air conditioning odors**

- During use, various odors from inside and outside the vehicle may enter into and accumulate in the air conditioning system. This may then cause odor to be emitted from the vents.
- To reduce potential odors from occurring:
 - It is recommended that the air conditioning system be set to outside air mode prior to turning the vehicle off.
 - The start timing of the blower may be delayed for a short period of time immediately after the air conditioning system is started in AUTO mode.

■ **An odor comes from the air conditioning system due to the Stop & Start system operation (vehicles with a Stop & Start system)**

When the engine is stopped due to the Stop & Start system, an odor caused by moisture may be detected. This does not indicate a malfunction.

■ **Air conditioning filter**

→P. 398

3-1. Using the air conditioning system and defogger

CAUTION

■ To prevent the windshield from fogging up

Do not use  during cool air operation in extremely humid weather. The difference between the temperature of the outside air and that of the windshield can cause the outer surface of the windshield to fog up, blocking your vision.

NOTICE

■ To prevent battery discharge

Do not leave the air conditioning system on longer than necessary when the engine is stopped.

3-1. Using the air conditioning system and defogger Power heater*

This feature is used to keep the cabin warm in cold conditions.

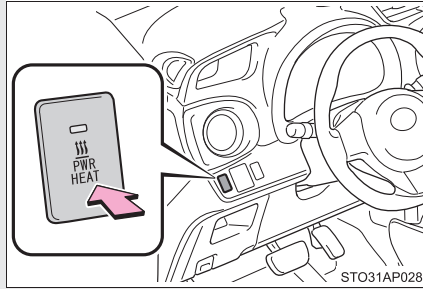

Turns the power heater on/off

The power heater turns on about 25 seconds after the button is pressed, and takes about another 85 seconds to warm up.

■ Power heater can be operated when

The engine is running.

■ Normal characteristics of power heater operation

The following cases do not indicate a malfunction:

- When the power heater is turned on or off, some white smoke and a slight odor may be emitted from the power heater exhaust that is located under the floor.
- When the power heater is used under extremely cold conditions, vapor may be visible from its exhaust.
- When the power heater is turned off, you may hear a sound in the engine compartment for about 2 minutes until the power heater turns off completely.

■ After the heater is turned off

We recommend not restarting the heater for 10 minutes after you turn it off. Otherwise, a noise may be heard as the heater ignites.

■ When refueling your vehicle

The engine must be turned off. Turning the engine off turns the power heater off.

*: If equipped

⚠ CAUTION

■ To prevent burns or damage to your vehicle

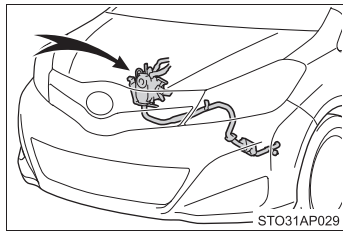

- Do not touch the heater or its exhaust pipe as they are hot. You may burn yourself.
- Keep flammable items such as fuel away from the heater and its exhaust pipe, as this may cause a fire.

⚠ NOTICE

■ To prevent damage to your vehicle

- Do not turn the heater on and off repeatedly in 5 minute intervals as this can shorten the life of the heater components. If the engine must be turned on and off repeatedly within short intervals (such as when the vehicle is being used for delivery purposes), turn the heater off.
- Do not modify or open the heater without consulting any authorized Toyota dealer or repairer, or another duly qualified and equipped professional, as this may cause a heater malfunction or a fire.
- Be careful not to splash or spill liquid directly on the heater or on the heater fuel pump, as this may cause the heater to malfunction.
- Keep the intake and exhaust pipes of the heater free from water, snow, ice, mud, etc. If the pipes become clogged, this can cause the heater to malfunction.
- If you notice anything unusual, such as a fluid leak, smoke and poor operation, turn off the heater and have your vehicle checked by any authorized Toyota dealer or repairer, or another duly qualified and equipped professional.

3-1. Using the air conditioning system and defogger Rear window and outside rear view mirror defoggers*

Defoggers are used to defog the rear window, and to remove rain-drops, dew and frost from the outside rear view mirrors (if equipped).

Vehicles with a manual air conditioning system

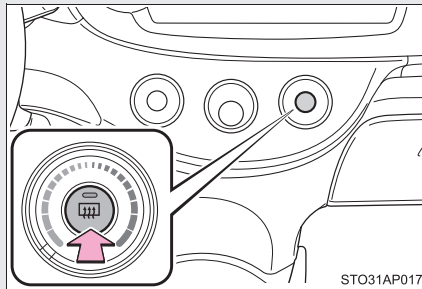

Turns the defoggers on/off

The defoggers will automatically turn off after approximately 15 minutes.

Vehicles with an automatic air conditioning system

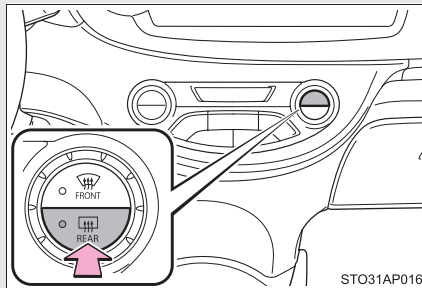

Turns the defoggers on/off

The defoggers will automatically turn off the operation time. The operation time is between 15 minutes and 1 hour depending on the ambient temperature and vehicle speed.

■ The defoggers can be operated when

Vehicles without a smart entry & start system

The engine switch is in the "ON" position.

Vehicles with a smart entry & start system

The "ENGINE START STOP" switch is in IGNITION ON mode.

■ The outside rear view mirror defoggers (if equipped)

Turning the rear window defogger on will turn the outside rear view mirror defoggers on.

*: If equipped

3-1. Using the air conditioning system and defogger

CAUTION

■ **When the outside rear view mirror defoggers are on (if equipped)**

Do not touch the outside surface of the rear view mirrors, as they can become very hot and burn you.

3-2. Using the audio system Audio system types*

Vehicles with a “touch screen”

Owners of models equipped with a “touch screen” should refer to the “touch screen” Owner’s Manual.

The illustrations below is for left-hand drive vehicles. Some button positions are reversed for right-hand drive vehicles.

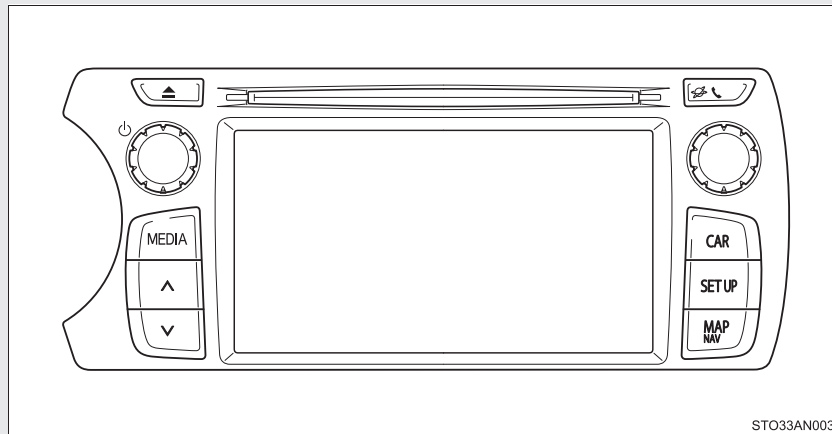

3

Interior features

*: If equipped

3-2. Using the audio system

Vehicles without a “touch screen”

CD player and AM/FM radio

The illustration below is for left-hand drive vehicles. Some button positions are reversed for right-hand drive vehicles.

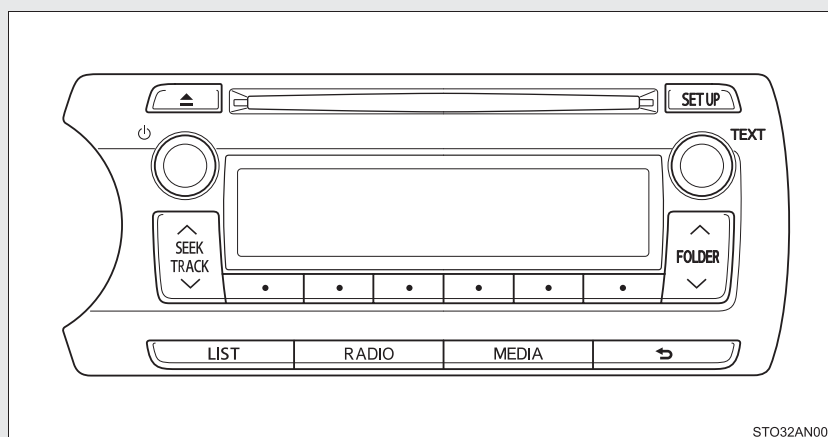

STO32AN001

Title	Page
Using the radio	P. 292
Using the CD player	P. 296
Playing back MP3 and WMA discs	P. 301
Operating an iPod	P. 307
Operating a USB memory	P. 315
Optimal use of the audio system	P. 322
Using the AUX port	P. 324
Using the steering wheel audio switches	P. 325

■ **Using cellular phones**

Interference may be heard through the audio system's speakers if a cellular phone is being used inside or close to the vehicle while the audio system is operating.

■ **Certification for the radio for Italy (vehicles with a “touch screen”)**

Il produttore “FUJITSU TEN (EUROPE) GmbH, Mündelheimer Weg 39, 40472 Düsseldorf, Germania” di questo modello numero FT0017A, dichiara che esso è conforme al D.M. 28/08/1995 Nr. 548, ottemperando alle prescrizioni di cui al D.M. 25/06/1985 (paragrafo 3, Allegato A) e D.M. 27/08/1987 (paragrafo 3, Allegato I).

3-2. Using the audio system

■ Certification for the Bluetooth® (vehicles with a “touch screen”)

FUJITSU TEN LIMITED
 Engineering Management Department
 Design Management Division
 Products Management Group
 2-28, Goshō-dori 1-chome, Hyogo-ku, Kobe, 652-8510, Japan
 Tel.: +81.78-682-2031 Fax.: +81.78-671-7160



DECLARATION of CONFORMITY

We, FUJITSU TEN LIMITED of the above address, hereby declare, at our sole responsibility, that the following product conforms to the Essential Requirements of the Radio and Telecommunications Terminal Equipment Directive 1999/5/EC in accordance with the tests conducted to the appropriate requirements of the relevant standards, as listed herewith.

Product Name:	CD Receiver with Bluetooth and Display
Model Number:	FT0017A
Reference Standards:	
	<u>Radio</u> :
	EN 300 328 V1.7.1(2006-10)
	<u>EMC</u> :
	EN 301 489-1 V1.8.1(2008-04)
	EN 301 489-17 V2.1.1(2009-05)
	<u>Safety</u> :
	EN 60065 2002+A1:2006+A11:2008

Supplementary Information:

CE Mark	
Member states intend for use	EU and EFTA
Member states with restrictive use	None

Signature:
 Takao KAMAI
 Position: Department General Manager
 Engineering Management Department
 Design Management Division
 Products Management Group
 Date of issue: 27 May 2010
 Place of issue: Kobe, Japan

The latest “DECLARATION of CONFORMITY” (DoC) is available at the address stated in the DoC.

Ovim ,FUJITSU TEN LIMITED, izjavljuje da ovaj FT0017A je usklađen sa bitnim zahtjevima idrugim relevantnim odredbama Direktive 1999/5/EC.

■ **About Bluetooth® (vehicles with a “touch screen”)**



Bluetooth is a registered trademark of Bluetooth SIG, Inc.

The Bluetooth wordmark and logo are owned by Bluetooth SIG, and permission has been granted to use the trademark of the licensee FUJITSU TEN LIMITED. Other trademarks and trade names are owned by various different owners.

 **NOTICE**

■ **To prevent battery discharge**

Do not leave the audio system on longer than necessary when the engine is stopped.

■ **To avoid damaging the audio system**

Take care not to spill drinks or other fluids over the audio system.

3-2. Using the audio system

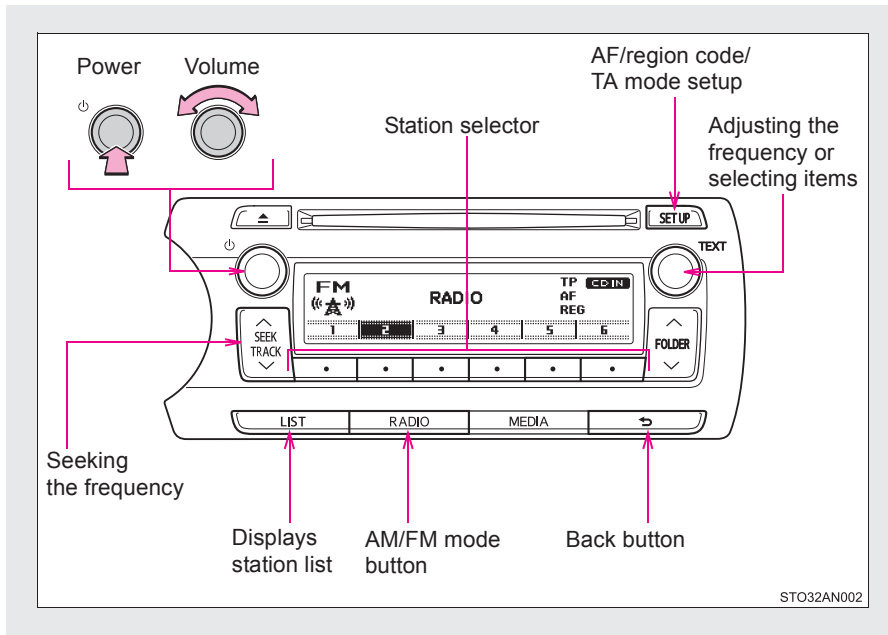

Using the radio*



Setting station presets

STEP 1 Search for desired stations by turning  or pressing “^” or

“v” on .

STEP 2 Press and hold the button (from  [1] to  [6]) the station is to be set to until you hear a beep.

*: If equipped

Using the station list

■ Updating the station list

STEP 1 Press  .

The station list will be displayed.

STEP 2 Press  (UPDATE) to update the list.

“Updating” is displayed while the searching is in process, and then available stations will be listed on the display.

To cancel the updating process, press  .

■ Selecting a station from the station list

STEP 1 Press  .

The station list will be displayed.

STEP 2 Turn  to select a station.

STEP 3 Press  to tune in the station.

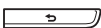
To return to the previous display, press  .

RDS (Radio Data System)

This feature allows your radio to receive station.

■ Listening to stations of the same network

STEP 1 Press  .

STEP 2 Turn  to “RADIO” and press  .

STEP 3 Turn  as corresponds to the desired mode: “FM AF” or “Region code”.

3-2. Using the audio system

STEP 4 Press  to select “ON” or “OFF”.

FM AF ON mode: The station among those of the same network with strong reception is selected.

Region code ON mode: The station among those of the same network with strong reception and broadcasting the same program is selected.

■ Traffic information

STEP 1 Press .

STEP 2 Turn  to “RADIO” and press .

STEP 3 Turn  to “FM TA” mode.

STEP 4 Press  to select “ON” or “OFF”.

TP mode: The system automatically switches to traffic information when a broadcast with a traffic information signal is received.

The station returns to the previous one when the traffic information ends.

TA mode: The system automatically switches to traffic information when a broadcast with a traffic information signal is received. In FM modes, the system will be mute unless traffic information is being broadcast.

The audio system returns to the previous mode when the traffic information ends.

■ Certification for the radio (for Italy)

IL PRODUTTORE Panasonic Corporation Automotive Systems Company
4261, Ikonobe-cho, Tsuzuki-ku, Yokohama, 224-8520, JAPAN
DI QUESTO APPARECCHIO MODELLO 86120 0D640 DICHIARA CHE
ESSO E'CONFORME AL D.M.28.08.1995 Nr.548, OTTEMPERANDO ALLE
PRESCRIZIONI DI CUI AL D.M.25.6.1985 (PARAGRAFO 3,ALL.A) ED AL
D.M.27.8.1987 (PARAGRAFO 3,ALL.I)

■ EON (Enhanced Other Network) system (for traffic announcement function)

If the RDS station (with EON data) you are listening to is not broadcasting a traffic information program and the audio system is in the TA (traffic announcement) mode, the radio will be switched automatically to a station broadcasting a traffic information program in the EON AF list when traffic information begins.

■ When the battery is disconnected

Stations presets are erased.

■ Reception sensitivity

- Maintaining perfect radio reception at all times is difficult due to the continually changing position of the antenna, differences in signal strength and surrounding objects, such as trains, transmitters, etc.
- The radio antenna is mounted on the rear roof. The antenna can be removed from the base by turning it.

■ Digital Audio Broadcast (DAB) radio

The optional radio antenna and tuner are necessary for the use of Digital Audio Broadcast (DAB) radio.

NOTICE

■ To prevent damage, remove the antenna in the following cases.

- The antenna will touch the ceiling of a garage.
- A cover will be put on the roof.

3-2. Using the audio system Using the CD player*

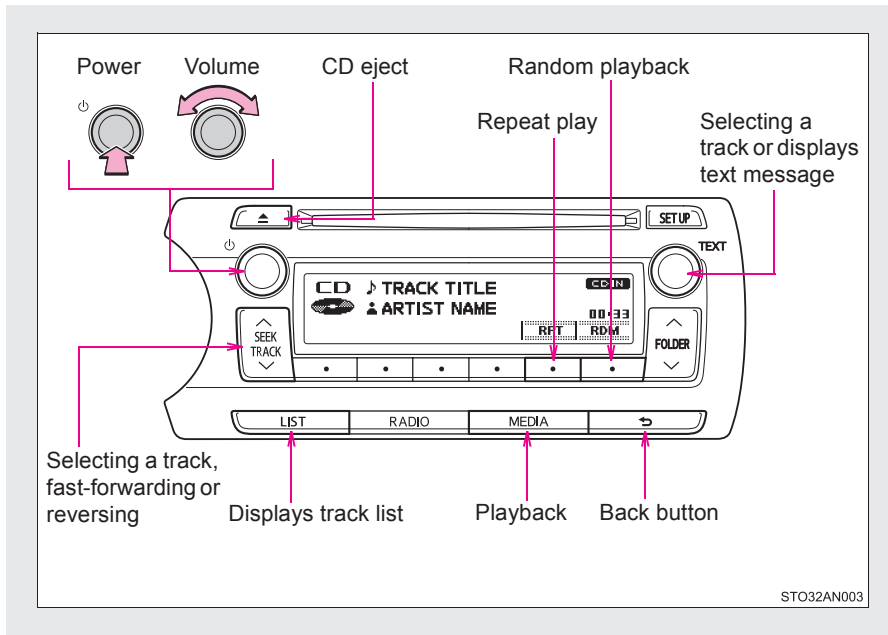



Loading CDs

Insert a CD.

Ejecting CDs

Press  and remove the CD.

Selecting a track

Turn  or press “^” to move up or “v” to move down using  until the desired track number is displayed.

*: If equipped

Selecting a track from a track list

STEP 1 Press .

The track list will be displayed.

STEP 2 Turn and press  to select a track.

To return to the previous display, press  or .

Fast-forwarding and reversing tracks

To fast-forward or reverse, press and hold “^” or “v” on .

Random playback

Press  (RDM).

To cancel, press  (RDM) again.

Repeat play

Press  (RPT).

To cancel, press  (RPT) again.

Switching the display

Press .

Track title, Artist name and CD title are shown on the display.

To return to the previous display, press  or .

■ **Display**

Up to 24 characters can be displayed.

Depending on the contents recorded, the characters may not be displayed properly or may not be displayed at all.

■ **Error messages**

“ERROR”: This indicates a problem either in the CD or inside the player.

“CD CHECK”: The CD may be dirty, damaged or inserted up-side down.

“WAIT”: Operation has stopped due to a high temperature inside the player. Wait for a while and then press  . If the CD still cannot be played back, contact any authorized Toyota dealer or repairer, or another duly qualified and equipped professional.

■ **Discs that can be used**

Discs with the marks shown below can be used.

Playback may not be possible depending on recording format or disc features, or due to scratches, dirt or deterioration.



CDs with copy-protect features may not be used.

■ **CD player protection feature**

To protect the internal components, playback is automatically stopped when a problem is detected while the CD player is being used.

■ **If a CD is left inside the CD player or in the ejected position for extended periods**

The CD may be damaged and may not play properly.

■ **Lens cleaners**

Do not use lens cleaners. Doing so may damage the CD player.

⚠ CAUTION

■ Certification for the CD player

This product is a class I laser product.

- A laser beam leak may result in hazardous radiation exposure.
- Do not open the cover of the player or attempt to repair the unit yourself. Refer servicing to qualified personnel.
- Laser power: No hazardous

⚠ NOTICE

■ CDs and adapters that cannot be used

Do not use the following types of CDs or 8 cm (3 in.) CD adapters or Dual Disc.

Doing so may damage the CD player and/or the CD insert/eject function.

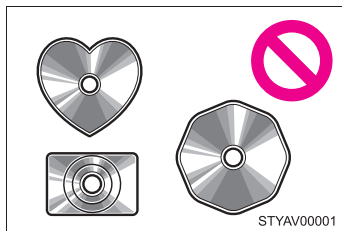

- CDs that have a diameter that is not 12 cm (4.7 in.)

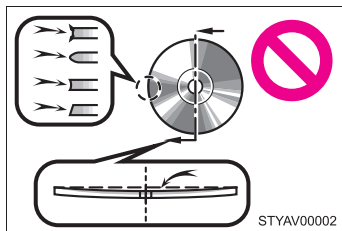

- Low-quality and deformed CDs

 NOTICE

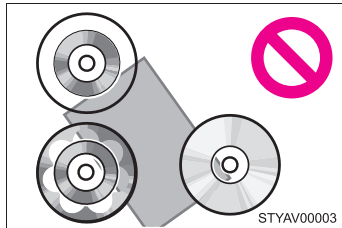

- CDs with a transparent or translucent recording area

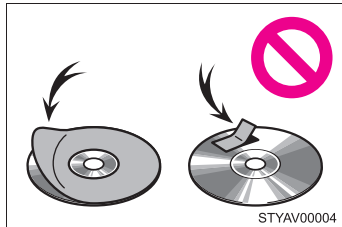

- CDs that have had tape, stickers or CD-R labels attached to them, or that have had the label peeled off

■ **CD player precautions**

Failure to follow the precautions below may result in serious damage to the CDs or the player itself.

- Do not insert anything other than CDs into the CD slot.
- Do not apply oil to the CD player.
- Store CDs away from direct sunlight.
- Never try to disassemble any part of the CD player.

3-2. Using the audio system

Playing back MP3 and WMA discs*

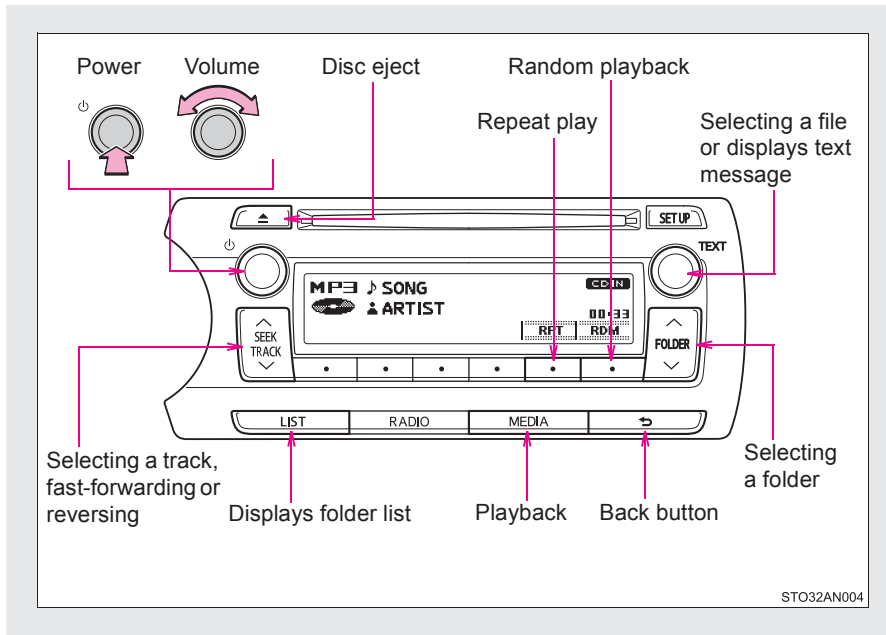

3

Interior features

Loading and ejecting MP3 and WMA discs

→P. 296

Selecting a folder

■ Selecting folders one at a time

Press “^” or “v” on  to select the desired folder.

*: If equipped

3-2. Using the audio system

■ Selecting a folder and file from folder list

STEP 1 Press  .

The folder list will be displayed.

STEP 2 Turn and press  to select a folder and a file.



To return to the previous display, press  .

To exit, press  .

■ Returning to the first folder

Press and hold “√” on  until you hear a beep.

Selecting files

Turn  or press “^” or “√” on  to select the desired file.

Fast-forwarding and reversing files

To fast-forward or reverse, press and hold “^” or “√” on  .

Random playback

Pressing  (RDM) changes modes in the following order:
Folder random → Disc random → Off

Repeat play

Pressing  (RPT) changes modes in the following order:
File repeat → Folder repeat* → Off

*: Available except when RDM (random playback) is selected

Switching the display

Press  .

Track title, Artist name and Album title (MP3 only) are shown on the display.

To return to the previous display, press  or  .

■ Display

Up to 24 characters can be displayed.

Depending on the contents recorded, the characters may not be displayed properly or may not be displayed at all.

■ Error messages

“ERROR”: This indicates a problem either in the CD or inside the player.

“CD CHECK”: The CD may be dirty, damaged or inserted up-side down.

“NO SUPPORT”: This indicates that the MP3/WMA file is not included in the CD.

■ Discs that can be used

Discs with the marks shown below can be used.

Playback may not be possible depending on recording format or disc features, or due to scratches, dirt or deterioration.



■ CD player protection feature

To protect the internal components, playback is automatically stopped when a problem is detected while the CD player is being used.

■ If a CD is left inside the CD player or in the ejected position for extended periods

The CD may be damaged and may not play properly.

■ **Lens cleaners**

Do not use lens cleaners. Doing so may damage the CD player.

■ **MP3 and WMA files**

MP3 (MPEG Audio LAYER3) is a standard audio compression format.

Files can be compressed to approximately 1/10 of their original size by using MP3 compression.

WMA (Windows Media Audio) is a Microsoft audio compression format.

This format compresses audio data to a size smaller than that of the MP3 format.

There is a limit to the MP3 and WMA file standards and to the media/formats recorded by them that can be used.

● **MP3 file compatibility**

- Compatible standards
MP3 (MPEG1 LAYER3, MPEG2 LSF LAYER3)
- Compatible sampling frequencies
MPEG1 LAYER3: 32, 44.1, 48 (kHz)
MPEG2 LSF LAYER3: 16, 22.05, 24 (kHz)
- Compatible bit rates (compatible with VBR)
MPEG1 LAYER3: 64, 80, 96, 112, 128, 160, 192, 224, 256, 320 (kbps)
MPEG2 LSF LAYER3: 64, 80, 96, 112, 128, 144, 160 (kbps)
- Compatible channel modes: stereo, joint stereo, dual channel and monaural

● **WMA file compatibility**

- Compatible standards
WMA Ver. 7, 8, 9
- Compatible sampling frequencies
32, 44.1, 48 (kHz)
- Compatible bit rates (only compatible with 2-channel playback)
Ver. 7, 8: CBR 48, 64, 80, 96, 128, 160, 192 (kbps)
Ver. 9: CBR 48, 64, 80, 96, 128, 160, 192, 256, 320 (kbps)

● **Compatible media**

Media that can be used for MP3 and WMA playback are CD-Rs and CD-RWs.

Playback in some instances may not be possible, depending on the status of the CD-R or CD-RW. Playback may not be possible or the audio may jump if the disc is scratched or marked with fingerprints.

● Compatible disc formats

The following disc formats can be used.

- Disc formats: CD-ROM Mode 1 and Mode 2
CD-ROM XA Mode 2, Form 1 and Form 2
- File formats: ISO9660 Level 1, Level 2, (Romeo, Joliet)
MP3 and WMA files written in any format other than those listed above may not play correctly, and their file names and folder names may not be displayed correctly.

Items related to standards and limitations are as follows.

- Maximum directory hierarchy: 8 levels
- Maximum length of folder names/file names: 32 characters
- Maximum number of folders: 192 (including the root)
- Maximum number of files per disc: 255

● File names

The only files that can be recognized as MP3/WMA and played are those with the extension .mp3 or .wma.

● Multi-sessions

As the audio system is compatible with multi-sessions, it is possible to play discs that contain MP3 and WMA files. However, only the first session can be played.

● ID3 and WMA tags

ID3 tags can be added to MP3 files, making it possible to record the track title, artist name, etc.

The system is compatible with ID3 Ver. 1.0, 1.1, and Ver. 2.2, 2.3 ID3 tags. (The number of characters is based on ID3 Ver. 1.0 and 1.1.)

WMA tags can be added to WMA files, making it possible to record the track title and artist name in the same way as with ID3 tags.

3-2. Using the audio system

● MP3 and WMA playback

When a disc containing MP3 or WMA files is inserted, all files on the disc are first checked. Once the file check is finished, the first MP3 or WMA file is played. To make the file check finish more quickly, we recommend you do not write in any files other than MP3 or WMA files or create any unnecessary folders.

If the discs contain a mixture of music data and MP3 or WMA format data, only music data can be played.

● Extensions

If the file extensions .mp3 and .wma are used for files other than MP3 and WMA files, they will be mistakenly recognized and played as MP3 and WMA files. This may result in large amounts of interference and damage to the speakers.

● Playback

- To play MP3 files with steady sound quality, we recommend a fixed bit rate of 128 kbps and a sampling frequency of 44.1 kHz.
- CD-R or CD-RW playback may not be possible in some instances, depending on the characteristics of the disc.
- There is a wide variety of freeware and other encoding software for MP3 and WMA files on the market, and depending on the status of the encoding and the file format, poor sound quality or noise at the start of playback may result. In some cases, playback may not be possible at all.
- When files other than MP3 or WMA files are recorded on a disc, it may take more time to recognize the disc and in some cases, playback may not be possible at all.
- Microsoft, Windows, and Windows Media are the registered trademarks of Microsoft Corporation in the U.S. and other countries.



NOTICE

■ **CDs and adapters that cannot be used (→P. 299)**

■ **CD player precautions (→P. 300)**

3-2. Using the audio system Operating an iPod*

Connecting an iPod enables you to enjoy music from the vehicle speakers.

■ Connecting an iPod

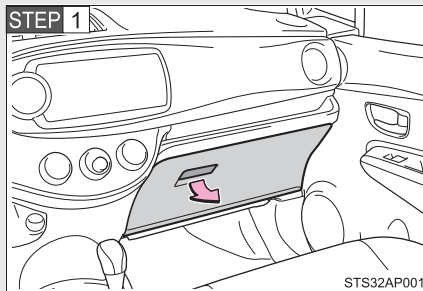

Pull up the lever to open the glove box.

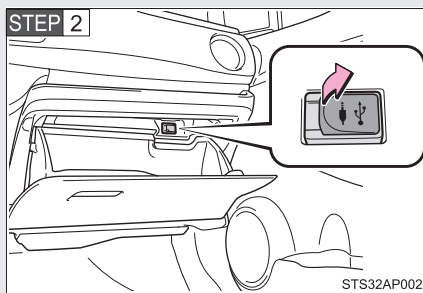

Open the cover and connect an iPod using an iPod cable.

Turn on the power of the iPod if it is not turned on.

STEP 3 Close the glove box and press  .

3

Interior features

*: If equipped

3-2. Using the audio system

■ Control panel

The illustration below is for left-hand drive vehicles. Some button positions are reversed for right-hand drive vehicles.

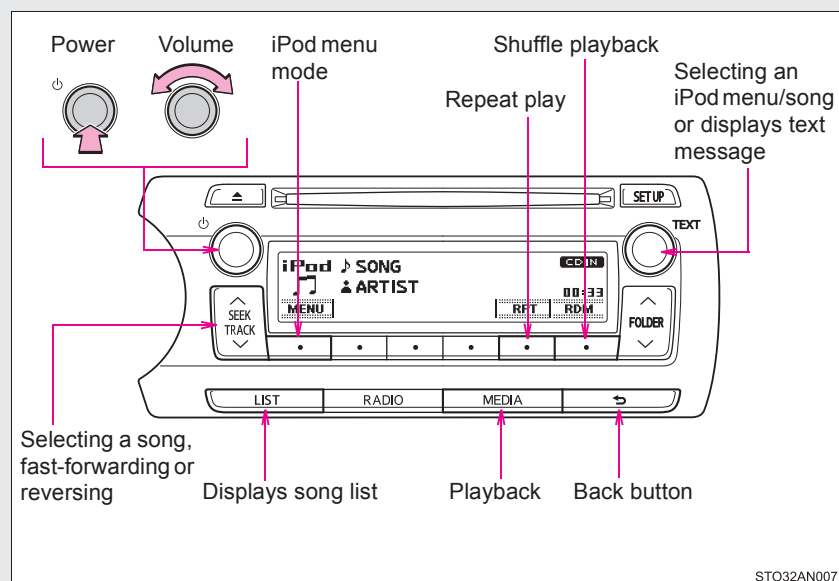

Selecting a play mode

STEP 1 Press  (MENU) to select iPod menu mode.

STEP 2 Turning  clockwise changes the play mode in the following order:

“Playlists” → “Artists” → “Albums” → “Songs” → “Podcasts”
→ “Genres” → “Composers” → “Audiobooks”

STEP 3 Press  to select the desired play mode.

■ Play mode list

Play mode	First selection	Second selection	Third selection	Fourth selection
“Playlists”	Playlists select	Songs select	-	-
“Artists”	Artists select	Albums select	Songs select	-
“Albums”	Albums select	Songs select	-	-
“Songs”	Songs select	-	-	-
“Podcasts”	Podcasts select	Episodes select	-	-
“Genres”	Genre select	Artists select	Albums select	Songs select
“Composers”	Composers select	Albums select	Songs select	-
“Audiobooks”	Audiobooks select	-	-	-

■ Selecting a list

STEP 1 Turn  to display the first selection list.

STEP 2 Press  to select the desired item.



Pressing the knob changes to the second selection list.

STEP 3 Repeat the same procedure to select the desired item.

To return to the previous selection list, press .

3-2. Using the audio system

Selecting songs

Turn  or press “^” or “v” on  to select the desired song.

Selecting a song from the song list

STEP 1 Press .

The song list will be displayed.

STEP 2 Turn  to select a song.

STEP 3 Press  to play the song.

To return to the previous display, press .



Fast-forwarding and reversing songs

To fast-forward or reverse, press and hold “^” or “v” on .

Shuffle playback

Pressing  (RDM) changes modes in the following order:
Track shuffle → Album shuffle → Off

Repeat play

Press  (RPT).
To cancel, press  (RPT) again.

Switching the display

Press .

Track title, Artist name and Album title are shown on the display.

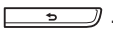
To return to the previous display, press  or .

Adjusting sound quality and volume balance

STEP 1 Press  to enter iPod menu mode.

STEP 2 Turning  changes sound modes. (→P. 322)

■ **About iPod**

- Apple is not responsible for the operation of this device or its compliance with safety and regulatory standards.
- iPod is a trademark of Apple Inc., registered in the U.S. and other countries.

■ **iPod functions**

- When an iPod is connected and the audio source is changed to iPod mode, the iPod will resume play from the same point in which it was last used.
- Depending on the iPod that is connected to the system, certain functions may not be available. If a function is unavailable due to a malfunction (as opposed to a system specification), disconnecting the device and reconnecting it once again may resolve the problem.
- While connected to the system, the iPod cannot be operated with its own controls. It is necessary to use the controls of the vehicle's audio system instead.

■ **iPod problems**

To resolve most problems encountered when using your iPod, disconnect your iPod from the vehicle iPod connection and reset it. For instructions on how to reset your iPod, refer to your iPod Owner's Manual.

■ **Display**

→P. 298

■ **Error messages**

- “ERROR”: This indicates a problem in the iPod or its connection.
- “NO SONGS”: This indicates that there is no music data in the iPod.
- “NO PLAYLISTS”: This indicates that some available songs are not found in a selected playlist.
- “UPDATE YOUR IPOD”: This indicates that the version of the iPod is not compatible. Upgrade your iPod software to the latest version.

■ Compatible models

Model	Generation	Software version
iPod	5th generation	Ver. 1.3.0 or higher
iPod nano	1st generation	Ver. 1.3.1 or higher
	2nd generation	Ver. 1.1.3 or higher
	3rd generation	Ver. 1.1.3 or higher
	4th generation	Ver. 1.0.4 or higher
	5th generation	Ver. 1.0.1 or higher
iPod touch	1st generation	Ver. 3.1.2 or higher
	2nd generation	Ver. 3.1.2 or higher
	Late 2009 (8 GB)	Ver. 3.1.2 or higher
	Late 2009 (32 GB/64 GB)	Ver. 3.1.2 or higher
iPod classic	1st generation	Ver. 1.1.2 or higher
	2nd generation (120 GB)	Ver. 2.0.1 or higher
	Late 2009 (160 GB)	Ver. 2.0.3 or higher
iPhone	1st generation (iPhone)	Ver. 3.1.2 or higher
	2nd generation (iPhone 3G)	Ver. 3.1.2 or higher
	3rd generation (iPhone 3GS)	Ver. 3.1.2 or higher
	4th generation (iPhone 4)	Ver. 4.0.0 or higher

Depending on differences between models or software version etc., some models listed above might be incompatible with this system.

iPod 4th generation and earlier models are not compatible with this system.

iPod mini, iPod shuffle and iPod photo are not compatible with this system.

Items related to standards and limitations are as follows:

- Maximum number of lists in device: 9999
- Maximum number of songs in device: 65535
- Maximum number of songs per list: 65535

3-2. Using the audio system

CAUTION

■ **Caution while driving**

Do not connect iPod or operate the controls.

NOTICE

■ **To prevent damage to iPod**

- Do not leave iPod in the vehicle. The temperature inside the vehicle may become high, resulting in damage to the iPod.
- Do not push down on or apply unnecessary pressure to the iPod while it is connected as this may damage the iPod or its terminal.
- Do not insert foreign objects into the port as this may damage the iPod or its terminal.

3-2. Using the audio system Operating a USB memory*

Connecting a USB memory enables you to enjoy music from the vehicle speakers.

■ Connecting a USB memory

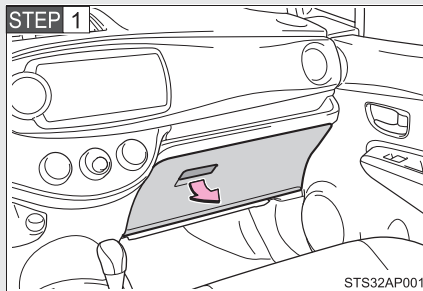

Pull up the lever to open the glove box.

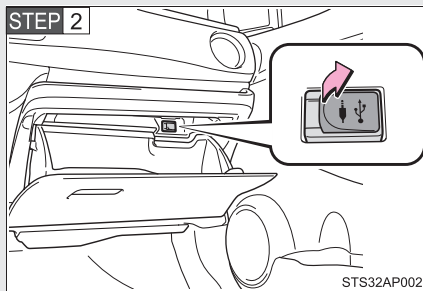

Open the cover and connect a USB memory.

Turn on the power of the USB memory if it is not turned on.

STEP 3 Close the glove box and press  .

3

Interior features

*: If equipped

3-2. Using the audio system

■ Control panel

The illustration below is for left-hand drive vehicles. Some button positions are reversed for right-hand drive vehicles.

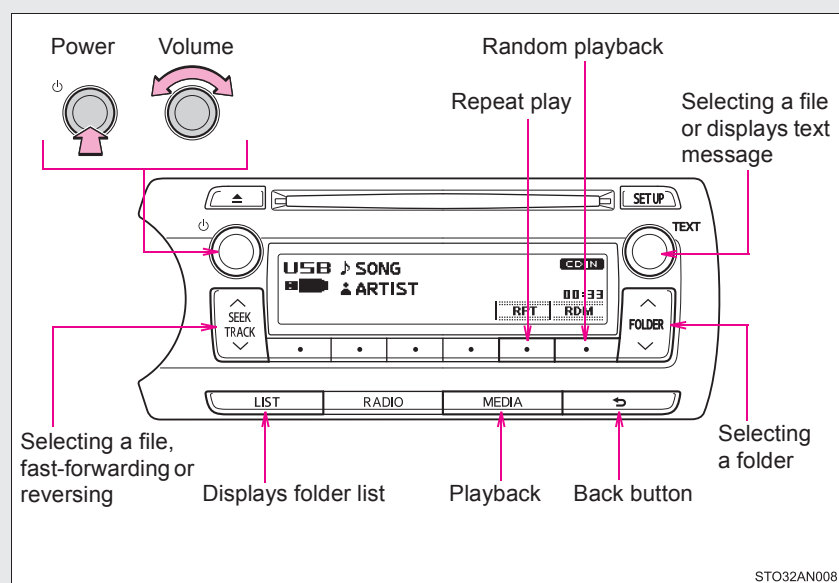

Selecting a folder

■ Selecting folders one at a time

Press “^” or “v” on  to select the desired folder.

■ Selecting a folder and file from folder list

STEP 1 Press .

The folder list will be displayed.

STEP 2 Turn and press  to select a folder and a file.

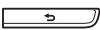

To return to the previous display, press .

To exit, press .

■ Returning to the first folder

Press and hold “√” on  until you hear a beep.

Selecting files

Turn  or press “^” or “√” on  to select the desired file.

Fast-forwarding and reversing files

To fast-forward or reverse, press and hold “^” or “√” on .

Random playback

Pressing  (RDM) changes modes in the following order:
Folder random → Disc random → Off

Repeat play

Pressing  (RPT) changes modes in the following order:
File repeat → Folder repeat* → Off

*: Available except when RDM (random playback) is selected

Switching the display

Press  .

Track title, Artist name and Album title (MP3 only) are shown on the display.

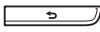
To return to the previous display, press  or  .

■ USB memory functions

- Depending on the USB memory that is connected to the system, the device itself may not be operable and certain functions may not be available. If the device is inoperable or a function is unavailable due to a malfunction (as opposed to a system specification), disconnecting the device and reconnecting it once again may resolve the problem.
- If the USB memory still does not begin operation after being disconnected and reconnected, format the memory.

■ Display

→P. 298

■ Error messages

“ERROR”: This indicates a problem in the USB memory or its connection.
“NO MUSIC”: This indicates that no MP3/WMA files are included in the USB memory.

■ USB memory

- Compatible devices
USB memory that can be used for MP3 and WMA playback

- Compatible device formats

The following device formats can be used:

- USB communication formats: USB2.0 FS (12 mbps)
- File formats: FAT16/32 (Windows)
- Correspondence class: Mass storage class

MP3 and WMA files written in any format other than those listed above may not play correctly, and their file names and folder names may not be displayed correctly.

Items related to standards and limitations are as follows:

- Maximum directory hierarchy: 8 levels
- Maximum number of folders in a device: 999 (including the root)
- Maximum number of files in a device: 9999
- Maximum number of files per folder: 255

- MP3 and WMA files

MP3 (MPEG Audio LAYER 3) is a standard audio compression format.

Files can be compressed to approximately 1/10 of their original size using MP3 compression.

WMA (Windows Media Audio) is a Microsoft audio compression format.

This format compresses audio data to a size smaller than that of the MP3 format.

There is a limit to the MP3 and WMA file standards that can be used and to the media/formats on which the files are recorded.

- MP3 file compatibility

- Compatible standards
MP3 (MPEG1 AUDIO LAYERII, III, MPEG2 AUDIO LAYERII, III, MPEG2.5)
- Compatible sampling frequencies
MPEG1 AUDIO LAYERII, III: 32, 44.1, 48 (kHz)
MPEG2 AUDIO LAYERII, III: 16, 22.05, 24 (kHz)
MPEG2.5: 8, 11.025, 12 (kHz)
- Compatible bit rates (compatible with VBR)
MPEG1 AUDIO LAYERII, III: 32-320 (kbps)
MPEG2 AUDIO LAYERII, III: 32-160 (kbps)
MPEG2.5: 32-160 (kbps)
- Compatible channel modes: stereo, joint stereo, dual channel and monaural

3-2. Using the audio system

- WMA file compatibility
 - Compatible standards
WMA Ver. 9
 - Compatible sampling frequencies
HIGH PROFILE 32, 44.1, 48 (kHz)
 - Compatible bit rates
HIGH PROFILE 32-320 (kbps, VBR)
- File names

The only files that can be recognized as MP3/WMA and played are those with the extension .mp3 or .wma.
- ID3 and WMA tags

ID3 tags can be added to MP3 files, making it possible to record the track title, artist name, etc.

The system is compatible with ID3 Ver. 1.0, 1.1, and Ver. 2.2, 2.3, 2.4 ID3 tags. (The number of characters is based on ID3 Ver. 1.0 and 1.1.)

WMA tags can be added to WMA files, making it possible to record the track title and artist name in the same way as with ID3 tags.
- MP3 and WMA playback
 - When a device containing MP3 or WMA files is connected, all files in the USB memory are checked. Once the file check is finished, the first MP3 or WMA file is played. To make the file check finish more quickly, we recommend that you do not include any files other than MP3 or WMA files or create any unnecessary folders.
 - When the USB memory is connected and the audio source is changed to USB memory mode, the USB memory will start playing the first file in the first folder. If the same device is removed and reinserted (and the contents have not been changed), the USB memory will resume play from the same point in which it was last used.
- Extensions

If the file extensions .mp3 and .wma are used for files other than MP3 and WMA files, they will be skipped (not played).

- Playback

- To play MP3 files with steady sound quality, we recommend a fixed bit rate of at least 128 kbps and a sampling frequency of 44.1 kHz.
- There is a wide variety of freeware and other encoding software for MP3 and WMA files on the market, and depending on the status of the encoding and the file format, poor sound quality or noise at the start of playback may result. In some cases, playback may not be possible at all.
- Microsoft, Windows, and Windows Media are registered trademarks of Microsoft Corporation in the U.S.A. and other countries.

 CAUTION

■ **Caution while driving**

Do not connect USB memory or operate the controls.

 NOTICE

■ **If the glove box cannot be fully closed**

Depending on the size and shape of the USB memory that is connected to the system, the glove box may not close fully. In this case, do not try to forcibly close the glove box, as this may damage the USB memory or the terminal, etc. Remove the USB memory, and use a different USB memory with a size and shape that allows the glove box to close fully when connected to the system.

■ **To prevent damage to USB memory**

- Do not leave USB memory in the vehicle. The temperature inside the vehicle may become high, resulting in damage to the player.
- Do not push down on or apply unnecessary pressure to the USB memory while it is connected as this may damage the USB memory or its terminal.
- Do not insert foreign objects into the port as this may damage the USB memory or its terminal.

3-2. Using the audio system

Optimal use of the audio system*

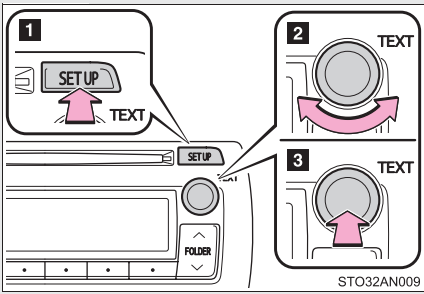

1 Displays the current mode

2 Changes the following setting

- Sound quality and volume balance (→P. 323)

The sound quality and balance setting can be changed to produce the best sound.

- Automatic Sound Levelizer on/off (→P. 323)

3 Selecting the mode

Using the audio control function

■ Changing sound quality modes

STEP 1 Press .

STEP 2 Turn  to select “Sound Setting”.

STEP 3 Press .

STEP 4 Turn  as corresponds to the desired mode.

“BASS”, “TREBLE”, “FADER”, “BALANCE”, or “ASL”

STEP 5 Press .

*: If equipped

■ Adjusting sound quality

Turning  adjusts the level.

Sound quality mode	Mode displayed	Level	Turn to the left	Turn to the right
Bass*	"BASS"	-5 to 5	Low	High
Treble*	"TREBLE"	-5 to 5		
Front/rear volume balance	"FADER"	R7 to F7	Shifts to rear	Shifts to front
Left/right volume balance	"BALANCE"	L7 to R7	Shifts to left	Shifts to right

*: The sound quality level is adjusted individually in each audio mode.

■ Adjusting the Automatic Sound Levelizer (ASL)

When ASL is selected, turning  to the right changes the amount of ASL in the order of LOW, MID and HIGH.

Turning  to the left turns ASL off.

ASL automatically adjusts the volume and tone quality according to vehicle speed.

3-2. Using the audio system Using the AUX port*

This port can be used to connect a portable audio device and listen to it through the vehicle's speakers.

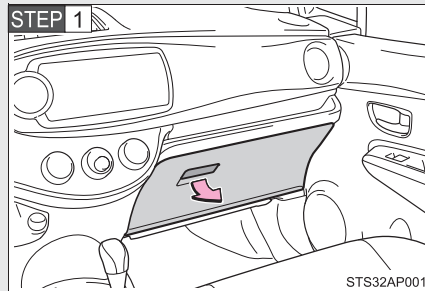

Pull up the lever to open the glove box.

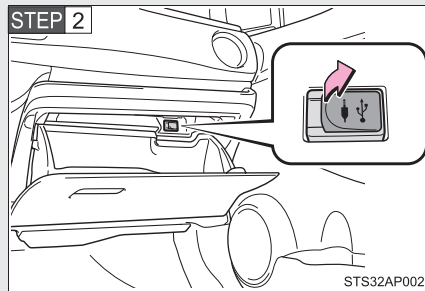

Open the cover and connect the portable audio device.

STEP 3 Close the glove box and press  until "AUX" is displayed.

■ Operating portable audio devices connected to the audio system

The volume can be adjusted using the vehicle's audio controls. All other adjustments must be made on the portable audio device itself.

■ When using a portable audio device connected to the power outlet

Noise may occur during playback. Use the power source of the portable audio device.

*: If equipped

3-2. Using the audio system

Using the steering wheel audio switches*

Some audio features can be controlled using the switches on the steering wheel.

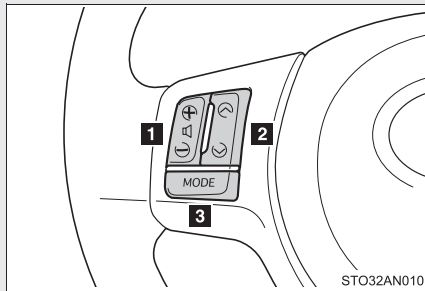



- 1** Volume
- 2** Radio mode: Select radio stations
CD mode: Select tracks and files (MP3 and WMA)
iPod mode: Selects a song
USB memory mode: Selects a file and folder
- 3** Power on, select audio source

Turning on the power

Press  when the audio system is turned off.

Changing the audio source

Press  when the audio system is turned on. The audio source changes as follows each time  is pressed. If a mode cannot be used, it will be skipped.

AM→FM→CD mode→iPod or USB memory mode*→AUX*

*: If equipped

3

Interior features

*: If equipped

3-2. Using the audio system

Adjusting the volume

Press “+” on  to increase the volume and “-” to decrease the volume.

Hold down “+” or “-” on  to continue increasing or decreasing the volume.

Silencing a sound

Press and hold .

To cancel, press and hold  again.

Selecting a radio station

STEP 1 Press  to select the radio mode.

STEP 2 Press “^” or “v” on  to select a preset station.

To scan for receivable stations, press and hold “^” or “v” on  until you hear a beep.

Selecting a track/file or song

STEP 1 Press  to select CD, iPod or USB memory mode.

STEP 2 Press “^” or “v” on  to select the desired track/file or song.

Selecting a folder (MP3 and WMA or USB memory)

STEP 1 Press  to select CD or USB memory mode.

STEP 2 Press and hold “^” or “v” on  until you hear a beep.

 CAUTION

■ **To reduce the risk of an accident**

Exercise care when operating the audio switches on the steering wheel.

3-3. Using the interior lights

Interior lights list

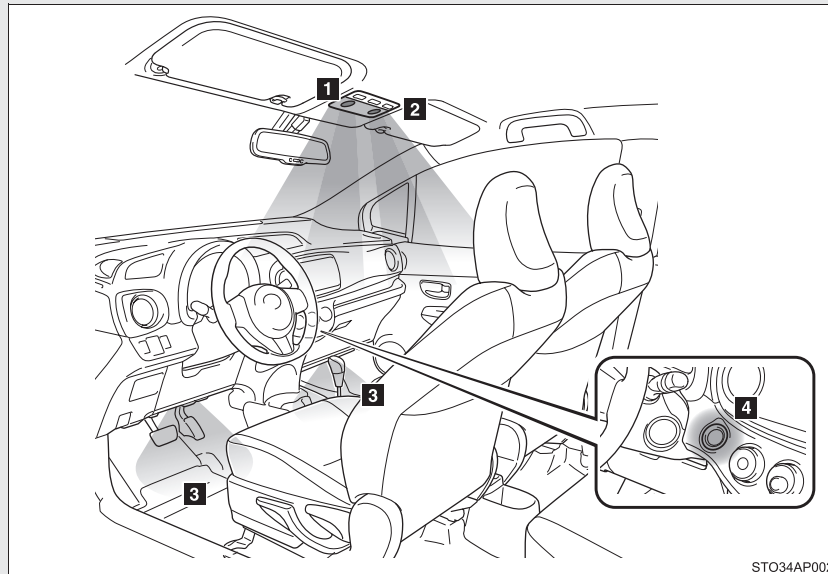

- 1** Interior light (→P. 329)
- 2** Personal lights (→P. 329)
- 3** Footwell lights (if equipped)
- 4** “ENGINE START STOP” switch light (vehicles with a smart entry & start system)

Personal lights

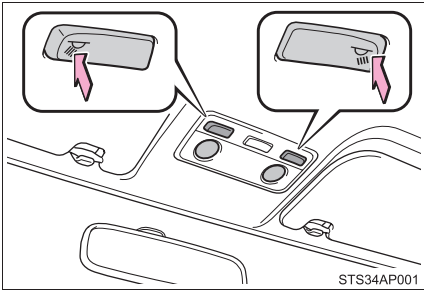

Turns the lights on/off

Interior light

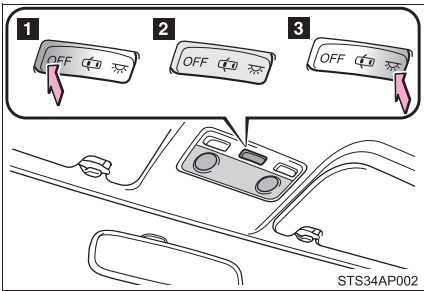

- 1** Turns the lights off
- 2** Turns the lights on/off linked to door position
- 3** Turns the lights on

■ Illuminated entry system**Vehicles without a smart entry & start system**

The lights automatically turn on/off according to the engine switch position, whether the doors are locked/unlocked, and whether the doors are open/closed.

Vehicles with a smart entry & start system

The lights automatically turn on/off according to “ENGINE START STOP” switch mode, the presence of the electronic key, whether the doors are locked/unlocked, and whether the doors are open/closed.

■ To prevent battery discharge

If the following lights remain on when the door is not fully closed, the lights will go off automatically after 20 minutes:

- Interior light (when the switch is in the door position)
- “ENGINE START STOP” switch light
- Footwell lights

■ Customization that can be configured at any authorized Toyota dealer or repair, or another duly qualified and equipped professional

Settings (e.g. the time elapsed before lights turn off) can be changed.
(Customizable features →P. 542)

3-4. Using the storage features

List of storage features

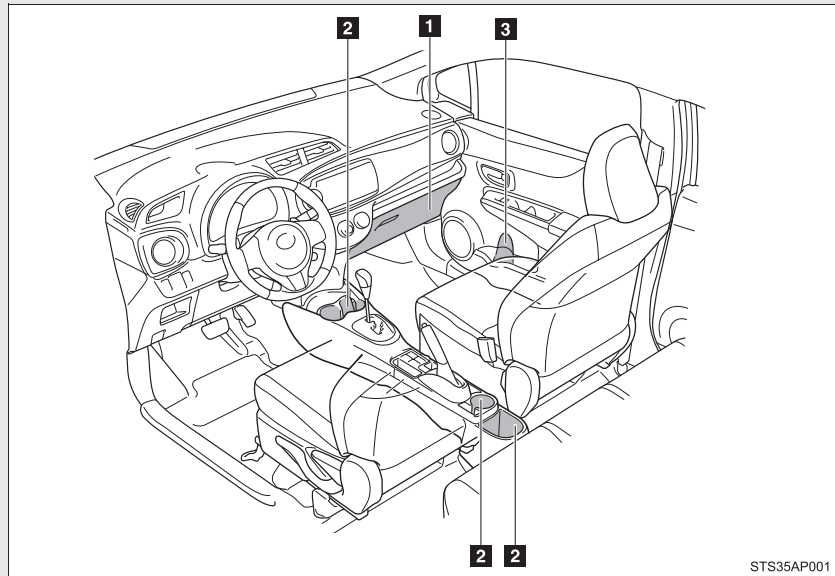

- 1 Glove box
- 2 Cup holders
- 3 Bottle holders

3

Interior features

CAUTION

■ Items that should not be left in the storage spaces

Do not leave glasses, lighters or spray cans in the storage spaces, as this may cause the following when cabin temperature becomes high:

- Glasses may be deformed by heat or cracked if they come into contact with other stored items.
- Lighters or spray cans may explode. If they come into contact with other stored items, the lighter may catch fire or the spray can may release gas, causing a fire hazard.

Glove box

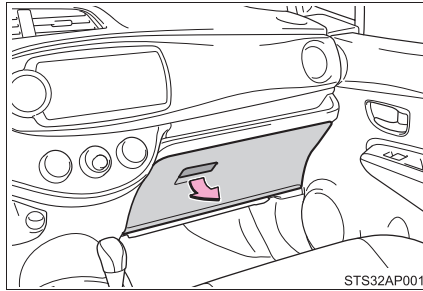

Pull up the lever to open the glove box.

■ **Owner's Manual storage inside the glove box**

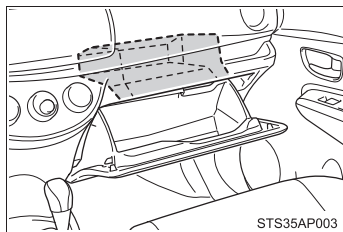

Inside the glove box, there is a compartment at the top that can be used to store the Owner's Manual.

■ **Using the glove box vent (if equipped)**

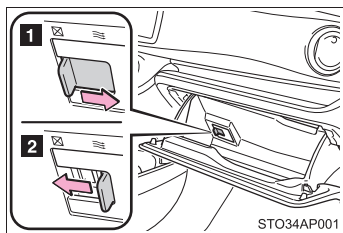

Air from the air conditioning system can be distributed into the glove box by opening and closing the vent.

- 1** Open
- 2** Close

The air is conditioned the same as the air for the passenger side vent.

Perishable items should not be put in the box.

⚠ CAUTION

■ Caution while driving

Keep the glove box closed. In the event of sudden braking, an accident may occur due to an occupant being struck by the open glove box or the items stored inside.

Cup holders

Front

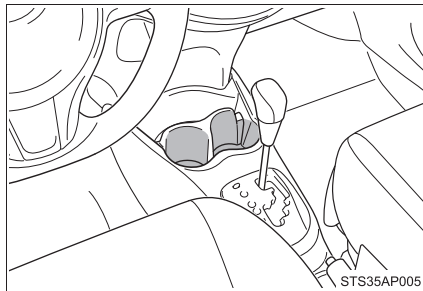

Rear

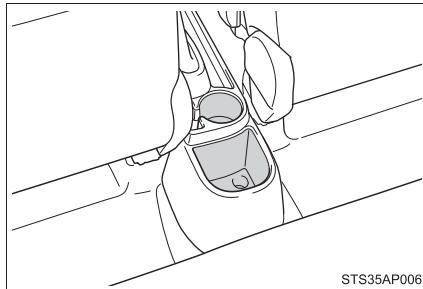

■ **Removing the separator**

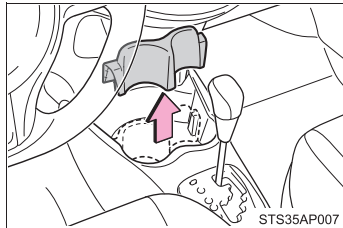

Pull the separator up.

⚠ CAUTION

■ **Items unsuitable for the cup holder**

Do not place anything other than cups or aluminum cans in the cup holders. Other items may be thrown out of the holders in the event of an accident or sudden braking, causing injury. If possible, cover hot drinks to prevent burns.

Bottle holders

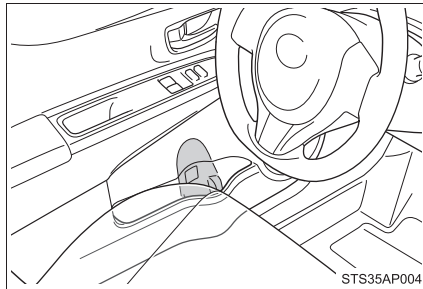

■ **When using the bottle holder**

- When storing a bottle, close the cap.
- The bottle may not be stored depending on its size or shape.

 CAUTION

■ **Items unsuitable for the bottle holder**

Do not place anything other than a bottle in the bottle holders. Other items may be thrown out of the holders in the event of an accident or sudden braking and cause injury.

 NOTICE

■ **Items that should not be stowed in the bottle holders**

Put the cap on before stowing a bottle. Do not place open bottles in the bottle holders, or glasses and paper cups containing liquid. The contents may spill and glasses may break.

3-5. Other interior features

Sun visors

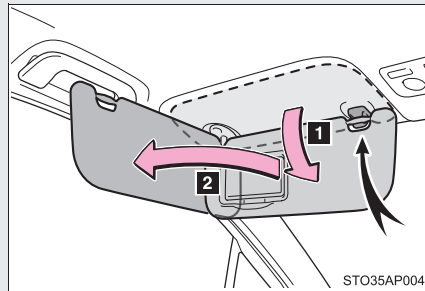

- 1** To set the visor in the forward position, flip it down.
- 2** To set the visor in the side position, flip down, unhook, and swing it to the side.

3-5. Other interior features

Vanity mirrors

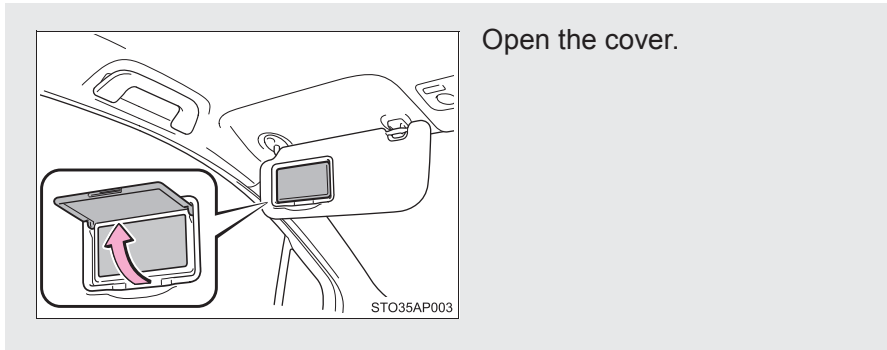

■ Vanity lights (if equipped)

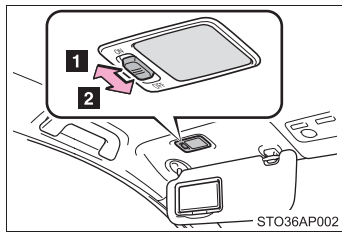

■ Vanity lights can be used when

Vehicles without a smart entry & start system

The engine switch is in the “ACC” or “ON” position.

Vehicles with a smart entry & start system

The “ENGINE START STOP” switch is ACCESSORY or IGNITION ON mode.

NOTICE

■ To prevent battery discharge (vehicles with vanity lights)

Do not leave the vanity lights on for extended periods while the engine is off.

3-5. Other interior features

Clock

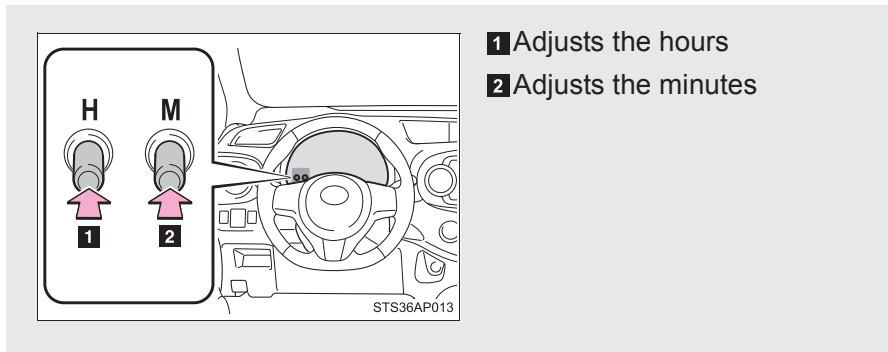

■ The clock is displayed when

Vehicles without a smart entry & start system

The engine switch is in the "ON" position.

Vehicles with a smart entry & start system

The "ENGINE START STOP" switch is in IGNITION ON mode.

■ When disconnecting and reconnecting battery terminals

The clock data will be reset.

3-5. Other interior features

Outside temperature display

The temperature display shows temperatures within the range of -40°C (-40°F) and 50°C (122°F).

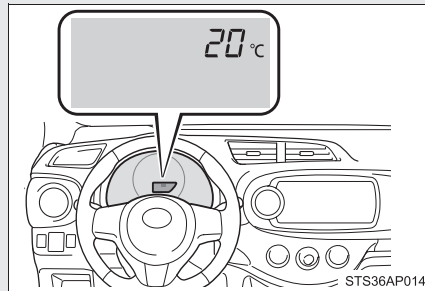

■ The outside temperature is displayed when

Vehicles without a smart entry & start system

The engine switch is in the “ON” position.

Vehicles with a smart entry & start system

The “ENGINE START STOP” switch is in IGNITION ON mode.

■ Display

In the following situations, the correct outside temperature may not be displayed, or the display may take longer than normal to change:

- When the vehicle is stopped, or moving at low speeds (less than 25 km/h [16 mph])
- When the outside temperature has changed suddenly (at the entrance/exit of a garage, tunnel, etc.)

■ When “-” or “E” is displayed

The system may be malfunctioning. Take your vehicle to any authorized Toyota dealer or repairer, or another duly qualified professional.

3-5. Other interior features

Portable ashtray*

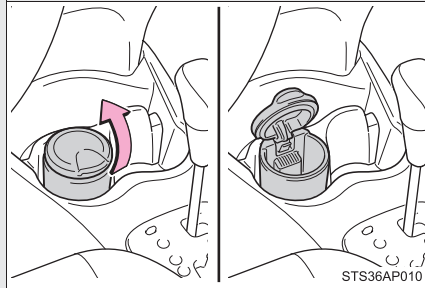

The ashtray can be installed in a cup holder. (→P. 333)

⚠ CAUTION

■ When not in use

Keep the ashtray closed. In the event of sudden braking, an accident may occur due to an occupant being struck by the open ashtray or ash flying out.

■ To prevent fire

- Fully extinguish matches and cigarettes before putting them in the ashtray, then make sure the ashtray is fully closed.
- Do not place paper or any other type of flammable object in the ashtray.

*: If equipped

3-5. Other interior features

Cigarette lighter*

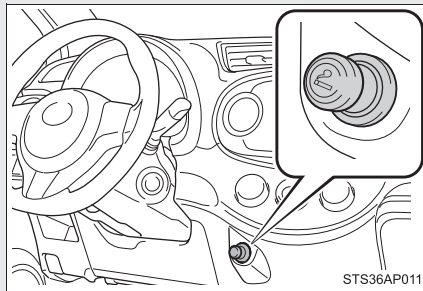

Push the cigarette lighter.

The cigarette lighter will pop up when it is ready for use.

■ The cigarette lighter can be used when

Vehicles without a smart entry & start system

The engine switch is in the “ACC” or “ON” position.

Vehicles with a smart entry & start system

The “ENGINE START STOP” switch is in ACCESSORY or IGNITION ON mode.

⚠ CAUTION

■ To avoid burns or fires

- Do not touch the metal parts of the cigarette lighter.
- Do not hold the cigarette lighter down. It could overheat and cause a fire.
- Do not insert anything other than the cigarette lighter provided into the cigarette lighter outlet. Doing so may deform the outlet and make the cigarette lighter pop out of the outlet or become difficult to take out.

*: If equipped

3-5. Other interior features

Power outlet*

The power outlet can be used for 12 V accessories that run on less than 10 A.

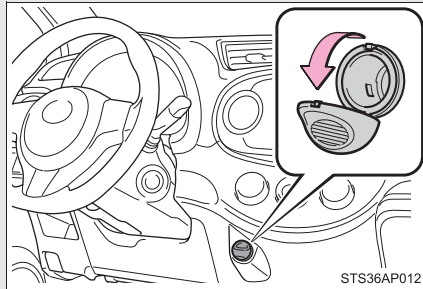

■ The power outlet can be used when

Vehicles without a smart entry & start system

The engine switch is in the “ACC” or “ON” position.

Vehicles with a smart entry & start system

The “ENGINE START STOP” switch is in ACCESSORY or IGNITION ON mode.

NOTICE

■ To avoid damaging the power outlet

Close the power outlet lid when the power outlet is not in use.

Foreign objects or liquids that enter the power outlet may cause a short circuit.

■ To prevent blown fuse

Do not use an accessory that uses more than 12 V 10 A.

■ To prevent battery discharge

Do not use the power outlet longer than necessary when the engine is not running.

*: If equipped

3-5. Other interior features

Seat heaters*

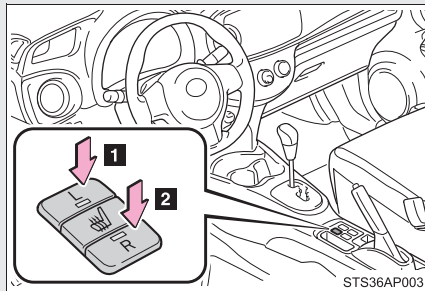

- 1 Heats the left front seat
 - 2 Heats the right front seat
- The indicator light comes on.

■ The seat heaters can be used when

Vehicles without a smart entry & start system

The engine switch is in the "ON" position.

Vehicles with a smart entry & start system

The "ENGINE START STOP" switch is in IGNITION ON mode.

■ When not in use

Turn the seat heater off.

*: If equipped

 CAUTION

■ **Burns**

- Use caution when seating the following persons in a seat with the seat heater on to avoid the possibility of burns:
 - Babies, small children, the elderly, the sick and the physically challenged
 - Persons with sensitive skin
 - Persons who are fatigued
 - Persons who have taken alcohol or drugs that induce sleep (sleeping drugs, cold remedies, etc.)
- Do not cover the seat with anything when using the seat heater. Using the seat heater with a blanket or cushion increases the temperature of the seat and may lead to overheating.
- Do not use the seat heater more than necessary. Doing so may cause minor burns or overheating.

 NOTICE

■ **To prevent seat heater damage**

Do not put heavy objects that have an uneven surface on the seat and do not stick sharp objects (needles, nails, etc.) into the seat.

■ **To prevent battery discharge**

Turn the seat heaters off when the engine is not running.

3-5. Other interior features

Armrest*

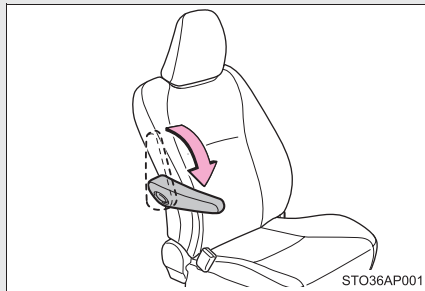

Fold down the armrest for use.

 **NOTICE**

- **To prevent damage to the armrest**
Do not apply too much load on the armrest.

3

Interior features

*: If equipped

345

3-5. Other interior features

Panoramic roof shade*

The panoramic roof shade can be opened and closed manually.

■ Opening the panoramic roof shade

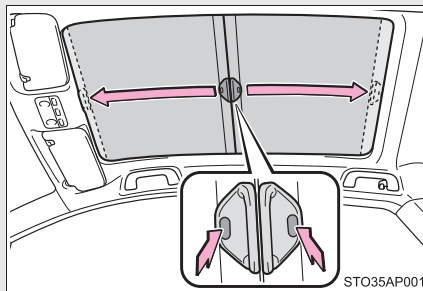

Pushing the tabs will release the lock, and the shade can be opened.

■ Closing the panoramic roof shade

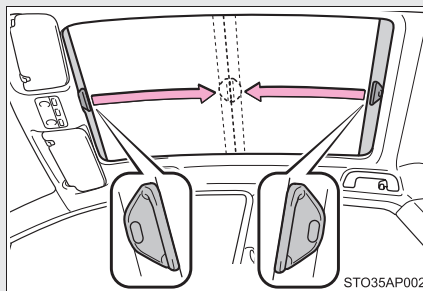

Pull the tabs to the lock position to close the shade.

*: If equipped

3-5. Other interior features

Floor mat

Use only floor mats designed specifically for vehicles of the same model and model year as your vehicle. Fix them securely in place onto the carpet.

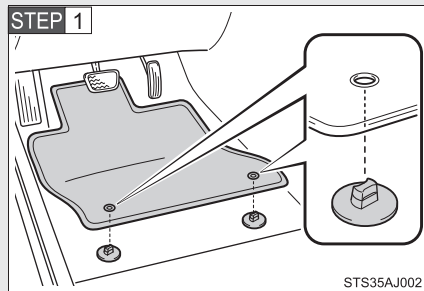

Insert the retaining hooks (clips) into the floor mat eyelets.

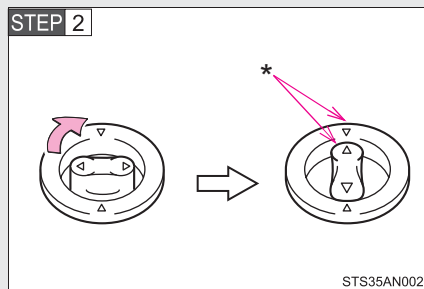

Turn the upper knob of each retaining hook (clip) to secure the floor mats in place.

*: Always align the \triangle marks.

The shape of the retaining hooks (clips) may differ from that shown in the illustration.

⚠ CAUTION

Observe the following precautions.

Failure to do so may cause the driver's floor mat to slip, possibly interfering with the pedals while driving. An unexpectedly high speed may result or it may become difficult to stop the vehicle, leading to a serious accident.

■ **When installing the driver's floor mat**

- Do not use floor mats designed for other models or different model year vehicles, even if they are Toyota Genuine floor mats.
- Only use floor mats designed for the driver's seat.
- Always install the floor mat securely using the retaining hooks (clips) provided.
- Do not use two or more floor mats on top of each other.
- Do not place the floor mat bottom-side up or upside-down.

■ **Before driving**

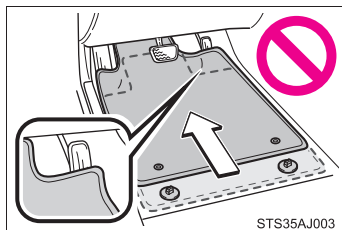

- Check that the floor mat is securely fixed in the correct place with all the provided retaining hooks (clips). Be especially careful to perform this check after cleaning the floor.
- With the engine stopped and the shift lever in P (vehicles with a Multidrive) or N (vehicles with a multi-mode manual transmission or manual transmission), fully depress each pedal to the floor to make sure it does not interfere with the floor mat.

3-5. Other interior features

Luggage compartment features

■ Deck board (if equipped)

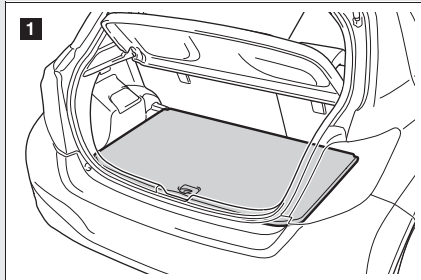

1 Upper position

2 Lower position

The lower position can be used when the deck board is placed on the luggage floor cover.

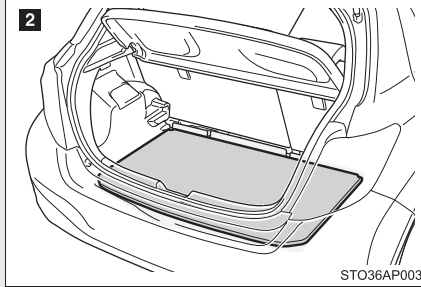

STO36AP003

■ Auxiliary box (if equipped)

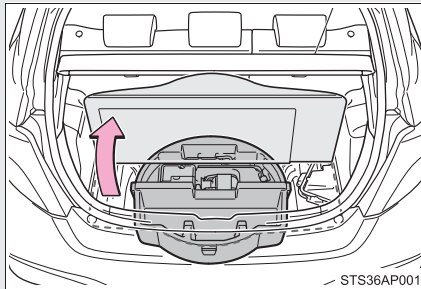

STO36AP001

Lift the deck board and the luggage floor cover.

3

Interior features

Removing the deck board

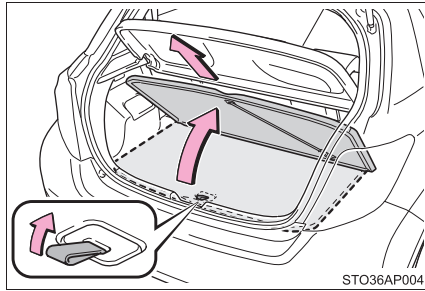

Lift the deck board and pull it toward you to remove it.

Securing the deck board

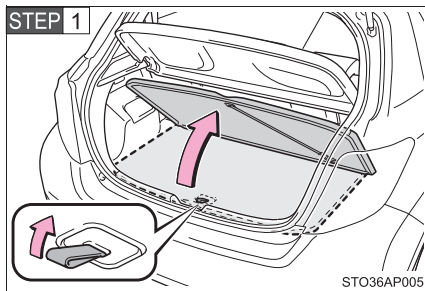

Lift the deck board up.

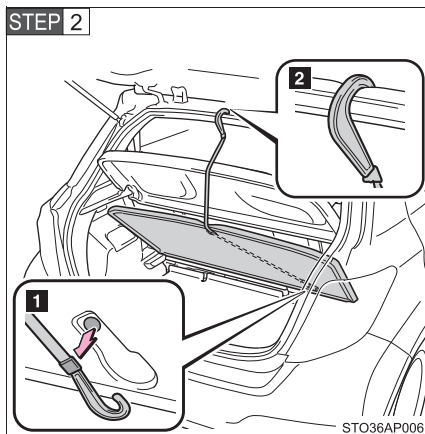

- 1 Remove the hook on the back-side of the deck board.
- 2 Attach the hook to the upper edge of the back door opening as shown.

■ **Removing the luggage cover**

The luggage cover can be removed by the following procedure:

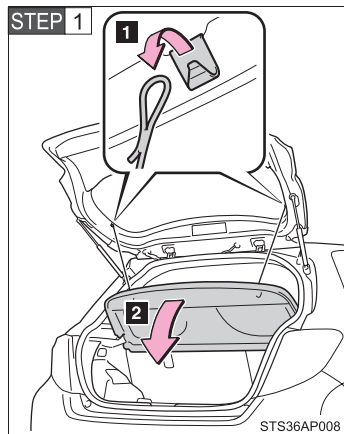

- 1 Unhook the cords.
- 2 Return the luggage cover to horizontal position.

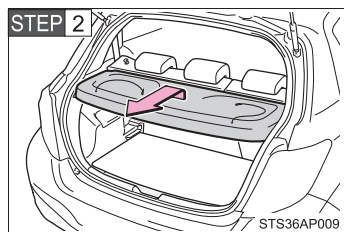

Lift the luggage cover and pull it forward.

3

Interior features

⚠ CAUTION

■ **When operating the deck board**

Do not place anything on the deck board when operating the board. Otherwise, your fingers may be caught or an accident may result causing injuries.

3-5. Other interior features

- 4-1. Maintenance and care**
 - Cleaning and protecting the vehicle exterior 354
 - Cleaning and protecting the vehicle interior 359

- 4-2. Maintenance**
 - Maintenance requirements..... 362

- 4-3. Do-it-yourself maintenance**
 - Do-it-yourself service precautions 365
 - Hood 368
 - Positioning a floor jack..... 370
 - Engine compartment..... 373
 - Tires..... 390
 - Tire inflation pressure 394
 - Wheels..... 396
 - Air conditioning filter 398
 - Wireless remote control/ electronic key battery..... 401
 - Checking and replacing fuses 405
 - Light bulbs 422

4-1. Maintenance and care

Cleaning and protecting the vehicle exterior

Perform the following to protect the vehicle and maintain it in prime condition:

- Working from top to bottom, liberally apply water to the vehicle body, wheel wells and underside of the vehicle to remove any dirt and dust.
- Wash the vehicle body using a sponge or soft cloth, such as a chamois.
- For hard-to-remove marks, use car wash soap and rinse thoroughly with water.
- Wipe away any water.
- Wax the vehicle when the waterproof coating deteriorates.

If water does not bead on a clean surface, apply wax when the vehicle body is cool.

■ Automatic car washes

- Fold the mirrors and remove the antenna before washing the vehicle. Start washing from the front of the vehicle. Make sure to re-install the antenna and extend the mirrors before driving.
- Brushes used in automatic car washes may scratch the vehicle surface and harm your vehicle's paint.
- Vehicles with a rear spoiler: In certain automatic car washes, the rear spoiler may interfere with machine operation. This may prevent the vehicle from being cleaned properly or result in damage to the rear spoiler.

■ High pressure car washes

- Do not allow the nozzles of the car wash to come within close proximity of the windows.
- Before using the car wash, check that the fuel filler door on your vehicle is closed properly.

■ **When using a car wash (vehicles with a smart entry & start system)**

If the door handle becomes wet while the electronic key is within the effective range, the door may lock and unlock repeatedly. Place the key in a position 2 m (6 ft.) or more separate from the vehicle while the vehicle is being washed. (Take care to ensure that the key is not stolen.)

■ **Aluminum wheels (if equipped)**

● Remove any dirt immediately by using a neutral detergent. Do not use hard brushes or abrasive cleaners. Do not use strong or harsh chemical cleaners.

Use the same mild detergent and wax as used on the paint.

● Do not use detergent on the wheels when they are hot, for example after driving for long distance in the hot weather.

● Wash detergent from the wheels immediately after use.

● To preserve the wheels' luster, do not allow hot water, such as from steam cleaning, to contact them directly.

■ **Bumpers**

Do not scrub with abrasive cleaners.

⚠ CAUTION

■ **When cleaning the windshield (vehicles with a rain-sensing windshield wiper)**

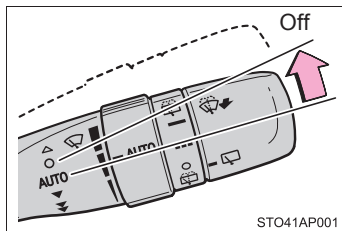

Set the wiper switch to off.
If the wiper switch is in "AUTO", the wiper may operate unexpectedly in the following situations, and may result in hands being caught or other serious injuries and cause damage to the wiper blades.

- When the upper part of the windshield where the raindrop sensor is located is touched by hand
- When a wet rag or similar is held close to the raindrop sensor
- If something bumps against the windshield
- If you directly touch the raindrop sensor body or if something bumps into the raindrop sensor

■ **When washing the vehicle**

Do not apply water to the inside of the engine compartment. Doing so may cause the electrical components etc. to catch fire.

■ **Precautions regarding the exhaust pipe**

Exhaust gasses cause the exhaust pipe to become quite hot.

When washing the vehicle, be careful not to touch the pipe until it has cooled sufficiently, as touching a hot exhaust pipe can cause burns.

 NOTICE

■ **To prevent paint deterioration and corrosion on the body and components (aluminum wheels etc.)**

- Wash the vehicle immediately in the following cases:
 - After driving near the sea coast
 - After driving on salted roads
 - If coal tar or tree sap is present on the paint surface
 - If dead insects, insect droppings or bird droppings are present on the paint surface
 - After driving in an area contaminated with soot, oily smoke, mine dust, iron powder or chemical substances
 - If the vehicle becomes heavily soiled with dust or mud
 - If liquids such as benzene and gasoline are spilled on the paint surface
- If the paint is chipped or scratched, have it repaired immediately.
- To prevent the wheels from corroding, remove any dirt and store in a place with low humidity when storing the wheels.

■ **Cleaning the exterior lights**

- Wash carefully. Do not use organic substances or scrub with a hard brush. This may damage the surfaces of the lights.
- Do not apply wax to the surfaces of the lights. Wax may cause damage to the lenses.

■ **Antenna installation and removal precautions**

- Before driving, ensure that the antenna is installed.
- When the antenna is removed, such as before entering an automatic car wash, make sure to store it in a suitable place so as not to lose it. Also, before driving, make sure to reinstall the antenna in its original position.

■ **When using an automatic car wash (vehicles with a rain-sensing windshield wiper)**

- Set the wiper switch to the off position.
If the wiper switch is in "AUTO", the wiper may operate and the wiper blade may be damaged.

 NOTICE

■ **To prevent damage to the antenna**

Remove the antenna in the following situations:

- When the antenna will touch the ceiling of a garage or other such places
- When a car cover is to be used to cover the vehicle

4-1. Maintenance and care

Cleaning and protecting the vehicle interior

The following procedures will help protect your vehicle's interior and keep it in top condition:

■ Protecting the vehicle interior

Remove dirt and dust using a vacuum cleaner. Wipe dirty surfaces with a cloth dampened with lukewarm water.

■ Cleaning the leather areas

- Remove dirt and dust using a vacuum cleaner.
- Wipe off any excess dirt and dust with a soft cloth dampened with diluted detergent.

Use a diluted water solution of approximately 5% neutral wool detergent.

- Wring out any excess water from the cloth and thoroughly wipe off all remaining traces of detergent.
- Wipe the surface with a dry, soft cloth to remove any remaining moisture. Allow the leather to dry in a shaded and ventilated area.

■ Cleaning the synthetic leather areas

- Remove loose dirt using a vacuum cleaner.
- Apply a mild soap solution to the synthetic leather using a sponge or soft cloth.
- Allow the solution to soak in for a few minutes. Remove the dirt and wipe off the solution with a clean, damp cloth.

■ **Caring for leather areas**

Toyota recommends cleaning the interior of the vehicle at least twice a year to maintain the quality of the vehicle's interior.

■ **Shampooing the carpets**

There are several commercial foaming-type cleaners available. Use a sponge or brush to apply the foam. Rub in overlapping circles. Do not use water. Wipe dirty surfaces and let them dry. Excellent results are obtained by keeping the carpet as dry as possible.

■ **Seat belts**

Clean with mild soap and lukewarm water using a cloth or sponge. Also check the belts periodically for excessive wear, fraying or cuts.

 **CAUTION**

■ **Water in the vehicle**

- Do not splash or spill liquid in the vehicle.
Doing so may cause electrical components etc. to malfunction or catch fire.
- Do not get any of the SRS components or wiring in the vehicle interior wet.
(→P. 112)
An electrical malfunction may cause the airbags to deploy or not function properly, resulting in death or serious injury.

■ **Cleaning the interior (especially instrument panel)**

Do not use polish wax or polish cleaner. The instrument panel may reflect off the windshield, obstructing the driver's view and leading to an accident, resulting in death or serious injury.

 NOTICE

■ Cleaning detergents

- Do not use the following types of detergent, as they may discolor the vehicle interior or cause streaks or damage to painted surfaces:
 - Non-seat portions: Organic substances such as benzene or gasoline, alkaline or acidic solutions, dye, and bleach
 - Seats: Alkaline or acidic solutions, such as thinner, benzene, and alcohol
- Do not use polish wax or polish cleaner. The instrument panel's or other interior part's painted surface may be damaged.

■ Preventing damage to leather surfaces

Observe the following precautions to avoid damage to and deterioration of leather surfaces:

- Remove any dust or dirt from leather surfaces immediately.
- Do not expose the vehicle to direct sunlight for extended periods of time. Park the vehicle in the shade, especially during summer.
- Do not place items made of vinyl, plastic, or containing wax on the upholstery, as they may stick to the leather surface if the vehicle interior heats up significantly.

■ Water on the floor

Do not wash the vehicle floor with water.

Vehicle systems such as the audio system may be damaged if water comes into contact with electrical components such as the audio system above or under the floor of the vehicle. Water may also cause the body to rust.

■ Cleaning the inside of the rear window

- Do not use glass cleaner to clean the rear window, as this may cause damage to the rear window defogger heater wires. Use a cloth dampened with lukewarm water to gently wipe the window clean. Wipe the window in strokes running parallel to the heater wires.
- Be careful not to scratch or damage the heater wires.

4-2. Maintenance

Maintenance requirements

To ensure safe and economical driving, day-to-day care and regular maintenance are essential. Toyota recommends performing the following maintenance:

■ Scheduled maintenance

Scheduled maintenance should be performed at specified intervals according to the maintenance schedule.

For full details of your maintenance schedule, refer to the “Toyota Service Booklet” or “Toyota Warranty Booklet”.

■ Do-it-yourself maintenance

What about do-it-yourself maintenance?

Many of the maintenance items are easy to do yourself if you have a little mechanical ability and a few basic automotive tools.

Note, however, that some maintenance tasks require special tools and skills. These are best performed by qualified technicians. Even if you are an experienced do-it-yourself mechanic, we recommend that repairs and maintenance be conducted by any authorized Toyota dealer or repairer, or another duly qualified and equipped professional. Any authorized Toyota dealer or repairer will keep a record of maintenance, which could be useful should you ever require Warranty Service. Should you choose to select a qualified and equipped professional other than an authorized Toyota repairer to service or maintain your vehicle, we recommend that you request that a record of maintenance be kept.

■ Where to go for service?

In order to maintain your vehicle in the best possible condition, Toyota recommends that all repairs and service operations be carried out by authorized Toyota dealers or repairers or other duly qualified and equipped professionals. For repairs and services covered by your warranty, please visit an authorized Toyota dealer or repairer, who will use genuine Toyota parts in repairing any difficulties you may encounter. There can also be advantages in utilizing authorized Toyota dealers or repairers for non-warranty repairs and services, as members of the Toyota network will be able to expertly assist you with any difficulties you may encounter.

Your Toyota dealer or repairer, or another duly qualified and equipped professional will perform all of the scheduled maintenance on your vehicle reliably and economically due to their experience with Toyota vehicles.

■ Does your vehicle need repairs?

Be on the alert for changes in performance and sounds, and visual tip-offs that indicate service is needed. Some important clues are:

- Engine missing, stumbling or pinging
- Appreciable loss of power
- Strange engine noises
- A fluid leak under the vehicle (However, water dripping from the air conditioning system after use is normal.)
- Change in exhaust sound (This may indicate a dangerous carbon monoxide leak. Drive with the windows open and have the exhaust system checked immediately.)
- Flat-looking tires, excessive tire squeal when cornering, uneven tire wear
- Vehicle pulls to one side when driven straight on a level road
- Strange noises related to suspension movement
- Loss of brake effectiveness, spongy feeling brake pedal or clutch pedal (vehicles with a manual transmission), pedal almost touches the floor, vehicle pulls to one side when braking
- Engine coolant temperature continually higher than normal

If you notice any of these clues, take your vehicle to any authorized Toyota dealer or repairer, or another duly qualified and equipped professional as soon as possible. Your vehicle may need adjustment or repair.

 CAUTION

■ **If your vehicle is not properly maintained**

Improper maintenance could result in serious damage to the vehicle and possible serious injury or death.

■ **Handling of the battery**

Battery posts, terminals and related accessories contain lead and lead compounds which are known to cause brain damage. Wash your hands after handling. (→P. 384)

4-3. Do-it-yourself maintenance

Do-it-yourself service precautions

If you perform maintenance by yourself, be sure to follow the correct procedures as given in these sections.

Items	Parts and tools
Battery condition (→P. 384)	<ul style="list-style-type: none">• Warm water• Baking soda• Grease• Conventional wrench (for terminal clamp bolts)• Distilled water
Engine coolant level (→P. 382)	<ul style="list-style-type: none">• “Toyota Super Long Life Coolant” or a similar high quality ethylene glycol-based non-silicate, non-amine, non-nitrite and non-borate coolant with long-life hybrid organic acid technology. “Toyota Super Long Life Coolant” is pre-mixed with 50% coolant and 50% deionized water.• Funnel (used only for adding coolant)
Engine oil level (→P. 376)	<ul style="list-style-type: none">• “Toyota Genuine Motor Oil” or equivalent• Rag or paper towel• Funnel (used only for adding engine oil)
Fuses (→P. 405)	<ul style="list-style-type: none">• Fuse with same amperage rating as original
Light bulbs (→P. 422)	<ul style="list-style-type: none">• Bulb with same number and wattage rating as original• Phillips-head screwdriver• Flathead screwdriver• Wrench
Radiator, condenser and inter-cooler (→P. 384)	—

4-3. Do-it-yourself maintenance

Items	Parts and tools
Tire inflation pressure (→P. 394)	<ul style="list-style-type: none">• Tire pressure gauge• Compressed air source
Washer fluid (→P. 387)	<ul style="list-style-type: none">• Water or washer fluid containing antifreeze (for winter use)• Funnel (used only for adding water or washer fluid)

CAUTION

The engine compartment contains many mechanisms and fluids that may move suddenly, become hot, or become electrically energized. To avoid death or serious injury, observe the following precautions:

■ When working on the engine compartment:

- Keep hands, clothing and tools away from the moving fan and engine drive belt.
- Be careful not to touch the engine, radiator, exhaust manifold, etc. right after driving as they may be hot. Oil and other fluids may also be hot.
- Do not leave anything that may burn easily, such as paper and rags, in the engine compartment.
- Do not smoke, cause sparks or expose an open flame to fuel or the battery. Fuel and battery fumes are flammable.
- Be extremely cautious when working on the battery. It contains poisonous and corrosive sulfuric acid.
- Take care because brake fluid can harm your hands or eyes and damage painted surfaces. If fluid gets on your hands or in your eyes, flush the affected area with clean water immediately.
If you still experience discomfort, consult a doctor.

 CAUTION**■ When working near the electric cooling fans or radiator grille**

Vehicles without a smart entry & start system:

Be sure the engine switch is in the “LOCK” position. With the engine switch in the “ON” position, the electric cooling fans may automatically start to run if the air conditioning is on and/or the coolant temperature is high. (→P. 384)

Vehicles with a smart entry & start system:

Be sure the “ENGINE START STOP” switch is OFF. With the “ENGINE START STOP” switch in IGNITION ON mode, the electric cooling fans may automatically start to run if the air conditioning is on and/or the coolant temperature is high. (→P. 384)

■ Safety glasses

Wear safety glasses to prevent flying or falling material, fluid spray, etc. from getting in your eyes.

 NOTICE**■ If you remove the air cleaner filter**

Driving with the air cleaner filter removed may cause excessive engine wear due to dirt in the air. Also, a backfire could cause a fire in the engine compartment.

■ If the fluid level is low or high

It is normal for the brake fluid level to go down slightly as the brake pads wear or when the fluid level in the accumulator is high.

If the reservoir needs frequent refilling, it may indicate a serious problem.

4-3. Do-it-yourself maintenance

Hood

Release the lock from the inside of the vehicle to open the hood.

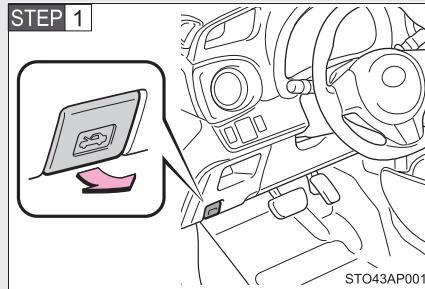

Pull the hood lock release lever.

The hood will pop up slightly.

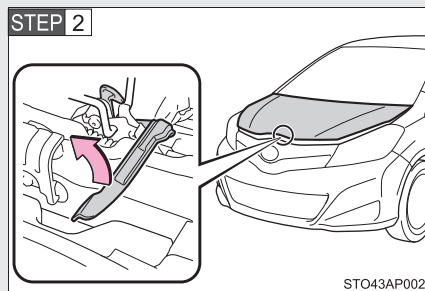

Pull up the auxiliary catch lever and lift the hood.

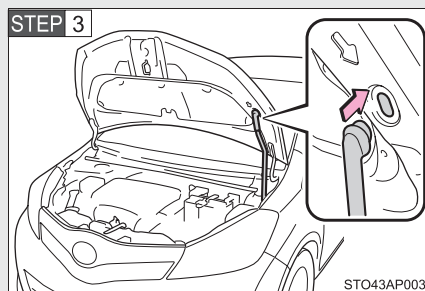

Hold the hood open by inserting the supporting rod into the slot.

 CAUTION

■ **Pre-driving check**

Check that the hood is fully closed and locked.
If the hood is not locked properly, it may open while the vehicle is in motion and cause an accident, which may result in death or serious injury.

■ **After installing the support rod into the slot**

Make sure the rod supports the hood securely from falling down on to your head or body.

 NOTICE

■ **When closing the hood**

Be sure to return the support rod to its clip before closing the hood. Closing the hood without returning the support rod properly could cause the hood to bend.

4-3. Do-it-yourself maintenance

Positioning a floor jack

When raising your vehicle with a floor jack, position the jack correctly. Improper placement may damage your vehicle or cause injury.

Front

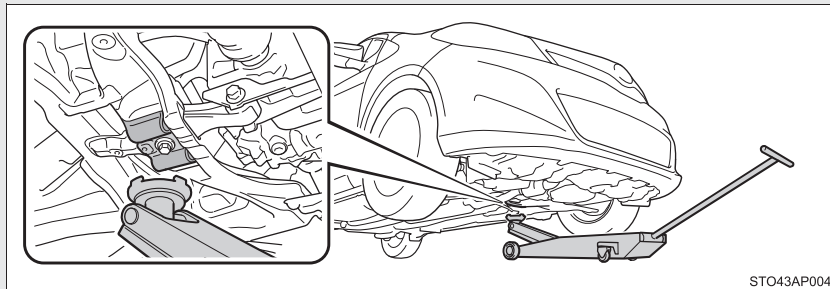

Rear

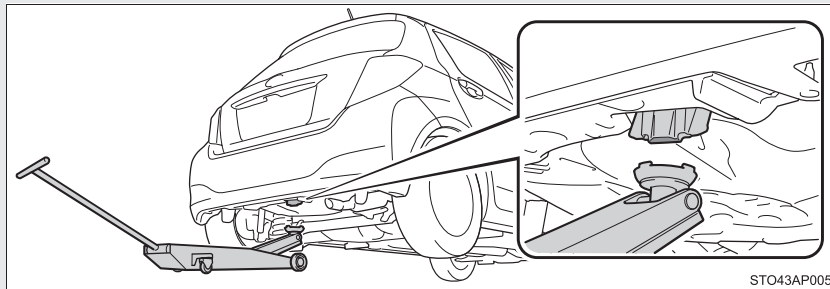

⚠ CAUTION**■ When raising your vehicle**

Make sure to observe the following precautions to reduce the possibility of death or serious injury:

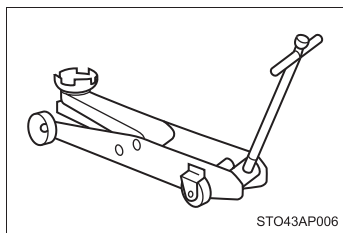

- Lift up the vehicle using a floor jack such as the one shown in the illustration.

- When using a floor jack, follow the instructions of the manual provided with the jack.
- Do not use the jack that was supplied with your vehicle.
- Do not put any part of your body underneath the vehicle when it is supported only by the floor jack.
- Always use floor jack and/or automotive jack stands on a solid, flat, level surface.
- Do not start the engine while the vehicle is supported by the floor jack.
- Stop the vehicle on level, firm ground, firmly set the parking brake and shift the shift lever to P (vehicles with a Multidrive), E, M or R (vehicles with a multi-mode manual transmission) or R (vehicles with a manual transmission).
- Make sure to set the floor jack properly at the jack point.
Raising the vehicle with an improperly positioned floor jack will damage the vehicle and may cause the vehicle to fall off the floor jack.

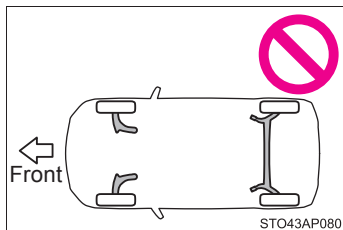

- Do not jack the vehicle at the suspension. The suspension may be damaged.

4-3. Do-it-yourself maintenance

 CAUTION

- Do not raise the vehicle while someone is in the vehicle.
- When raising the vehicle, do not place any object on top of or underneath the floor jack.

4-3. Do-it-yourself maintenance Engine compartment

1KR-FE engine

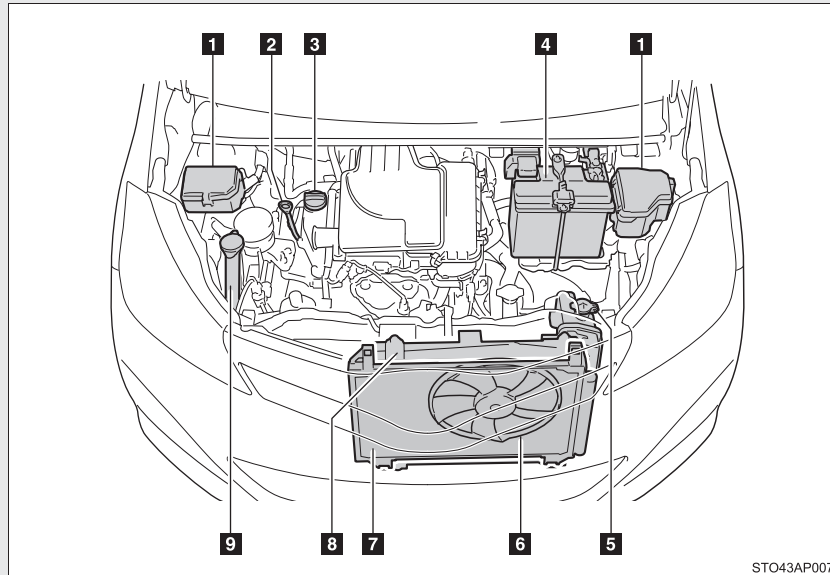

- | | |
|--|---|
| 1 Fuse boxes (→P. 405) | 5 Engine coolant reservoir (→P. 382) |
| 2 Engine oil level dipstick (→P. 376) | 6 Electric cooling fan |
| 3 Engine oil filler cap (→P. 378) | 7 Condenser (→P. 384) |
| 4 Battery (→P. 384) | 8 Radiator (→P. 384) |
| | 9 Washer fluid tank (→P. 387) |

4

Maintenance and care

1NR-FE engine

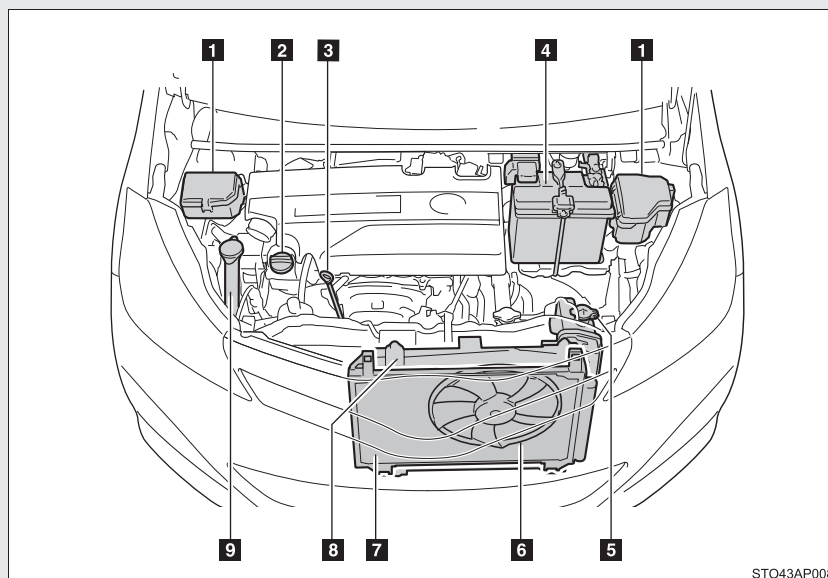

- | | | | |
|------------------------------------|-----------|-----------------------------------|-----------|
| 1 Fuse boxes | (→P. 405) | 5 Engine coolant reservoir | (→P. 382) |
| 2 Engine oil filler cap | (→P. 378) | 6 Electric cooling fan | |
| 3 Engine oil level dipstick | (→P. 376) | 7 Condenser | (→P. 384) |
| 4 Battery | (→P. 384) | 8 Radiator | (→P. 384) |
| | | 9 Washer fluid tank | (→P. 387) |

1ND-TV engine

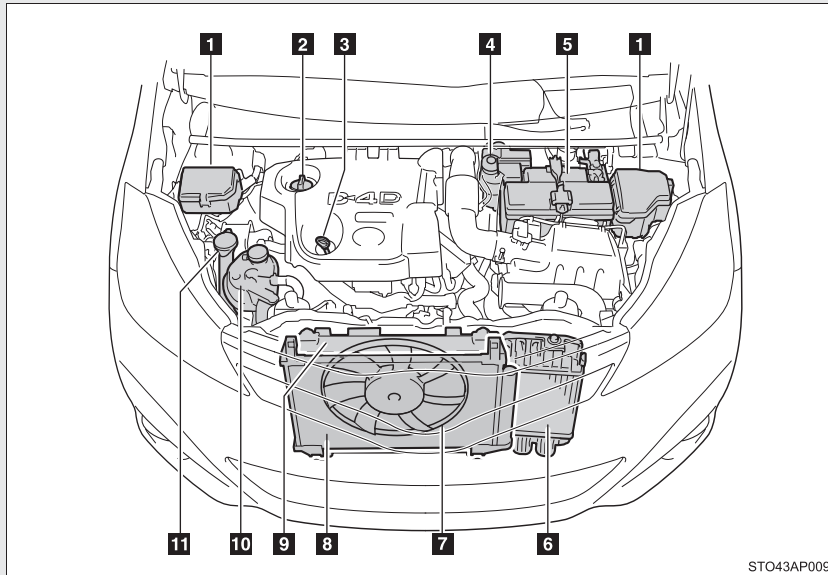

- | | | | |
|------------------------------------|-----------|------------------------------------|-----------|
| 1 Fuse boxes | (→P. 405) | 6 Intercooler | (→P. 384) |
| 2 Engine oil filler cap | (→P. 378) | 7 Electric cooling fan | |
| 3 Engine oil level dipstick | (→P. 376) | 8 Condenser | (→P. 384) |
| 4 Fuel filter | (→P. 389) | 9 Radiator | (→P. 384) |
| 5 Battery | (→P. 384) | 10 Engine coolant reservoir | (→P. 382) |
| | | 11 Washer fluid tank | (→P. 387) |

Engine oil

With the engine at operating temperature and turned off, check the oil level on the dipstick.

■ Checking the engine oil

STEP 1 Gasoline engine: Park the vehicle on level ground. After warming up the engine and turning it off, wait more than 5 minutes for the oil to drain back into the bottom of the engine.

Diesel engine: Park the vehicle on level ground. After warming up the engine and turning it off, wait more than 5 minutes for the oil to drain back into the bottom of the engine.

STEP 2 Holding a rag under the end, pull the dipstick out.

1KR-FE engine

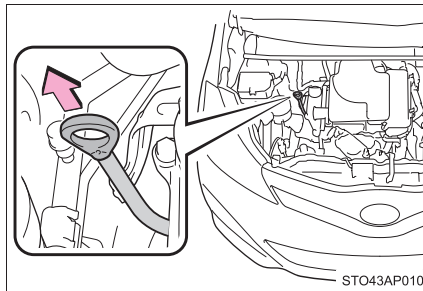

1NR-FE engine

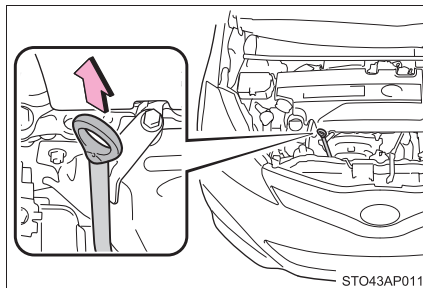

1ND-TV engine

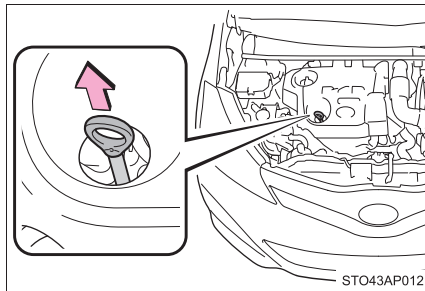

STEP 3 Wipe the dipstick clean.

STEP 4 Reinsert the dipstick fully.

STEP 5 Holding a rag under the end, pull the dipstick out and check the oil level.

STEP 6 Wipe the dipstick and reinsert it fully.

1KR-FE engine

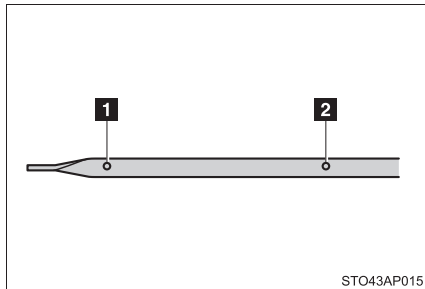

1 Low

2 Full

1NR-FE engine

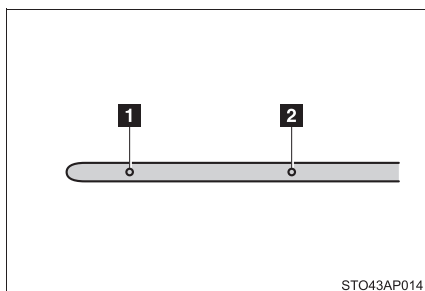

1 Low

2 Full

1ND-TV engine

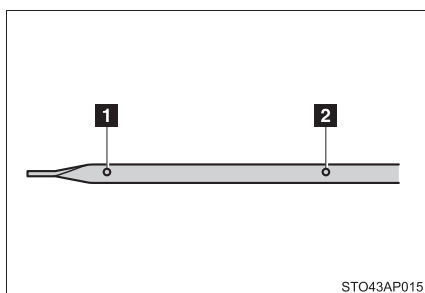

1 Low

2 Full

■ Adding engine oil

If the oil level is below or near the low level mark, add engine oil of the same type as that already in the engine.

1KR-FE engine

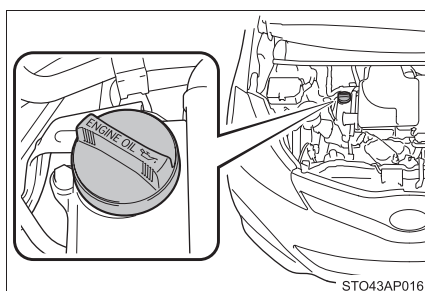

1NR-FE engine

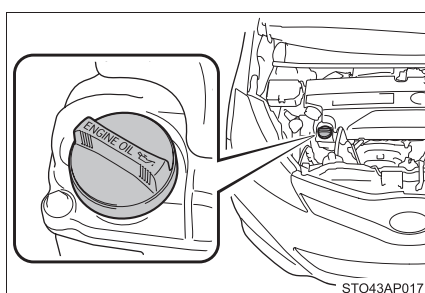

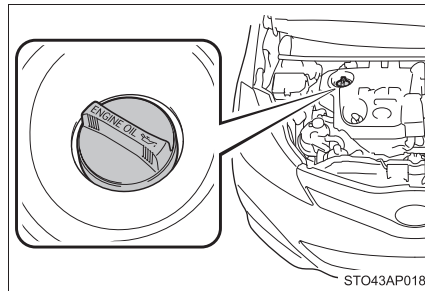
1ND-TV engine

Make sure to check the oil type and prepare the items needed before adding oil.

Engine oil selection	→P. 524
Oil quantity (Low → Full)	1.5 L (1.6 qt., 1.3 Imp. qt.)
Item	Clean funnel

STEP 1 Remove the oil filler cap by turning it counterclockwise.

STEP 2 Add engine oil slowly, checking the dipstick.

STEP 3 Install the oil filler cap by turning it clockwise.

■ Engine oil consumption

- The amount of engine oil consumed depends on the oil viscosity, the quality of the oil and the way the vehicle is driven.
- More oil is consumed under driving conditions such as high speeds and frequent acceleration and deceleration.
- A new engine consumes more oil.
- When judging the amount of oil consumption, keep in mind that the oil may have become diluted, making it difficult to judge the true level accurately.
- Oil consumption: Max. 1.0 L/1000 km (1.1 qt./600 miles, 0.9 Imp. qt./600 miles)

4-3. Do-it-yourself maintenance

- If your vehicle consumes more than 1.0 L (1.1 qt., 0.9 Imp. qt.) every 1000 km (600 miles), contact any authorized Toyota dealer or repairer, or another duly qualified and equipped professional.

■ After changing the engine oil (diesel engine only)

The engine oil maintenance data should be reset. Perform the following procedures:

STEP 1 Switch the display to the trip meter “A” when the engine is running.
(→P. 209)

STEP 2 Vehicles without a smart entry & start system:
Turn the engine switch to the “LOCK” position.
Vehicles with a smart entry & start system:
Turn the “ENGINE START STOP” switch off.

STEP 3 Vehicles without a smart entry & start system:
While pressing the display change button (→P. 209), turn the engine switch to the “ON” position (do not start the engine because reset mode will be canceled). Continue to press and hold the button until the trip meter displays “000000”.

Vehicles with a smart entry & start system:
While pressing the display change button (→P. 209), turn the “ENGINE START STOP” switch to the IGNITION ON mode (do not start the engine because otherwise the reset mode will be canceled). Continue to press and hold the button until the trip meter displays “000000”.

 CAUTION■ **Used engine oil**

- Used engine oil contains potentially harmful contaminants which may cause skin disorders such as inflammation and skin cancer, so care should be taken to avoid prolonged and repeated contact. To remove used engine oil from your skin, wash thoroughly with soap and water.
- Dispose of used oil and filters only in a safe and acceptable manner. Do not dispose of used oil and filters in household trash, in sewers or onto the ground. Call any authorized Toyota dealer or repairer, or another duly qualified and equipped professional, service station or auto parts store for information concerning recycling or disposal.
- Do not leave used engine oil within the reach of children.

 NOTICE■ **To prevent serious engine damage**

Check the oil level on a regular basis.

■ **When replacing the engine oil**

- Be careful not to spill engine oil on the vehicle components.
- Avoid overfilling, or the engine could be damaged.
- Check the oil level on the dipstick every time you refill the vehicle.
- Be sure the engine oil filler cap is properly tightened.

■ **Engine oil (vehicles with a DPF system*)**

Using an engine oil other than ACEA C2 may damage the catalytic converter.

*:To determine whether or not your vehicle has a DPF system, contact any authorized Toyota dealer or repairer, or another duly qualified and equipped professional.

Engine coolant

The coolant level is satisfactory if it is between the “FULL” and “LOW” lines on the reservoir when the engine is cold.

Gasoline engine

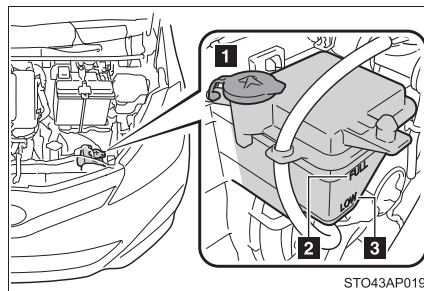

1 Reservoir cap

2 “FULL” line

3 “LOW” line

If the level is on or below the “LOW” line, add coolant up to the “FULL” line.

Diesel engine

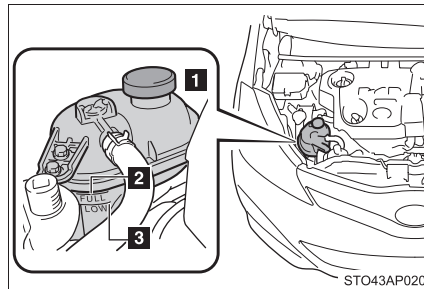

1 Reservoir cap

2 “FULL” line

3 “LOW” line

If the level is on or below the “LOW” line, add coolant up to the “FULL” line.

■ Coolant selection

Only use “Toyota Super Long Life Coolant” or a similar high quality ethylene glycol based non-silicate, non-amine, non-nitrite, and non-borate coolant with long-life hybrid organic acid technology.

“Toyota Super Long Life Coolant” is a mixture of 50% coolant and 50% deionized water. (Minimum temperature: -35°C [-31°F])

For more details about engine coolant, contact any authorized Toyota dealer or repairer, or another duly qualified and equipped professional.

■ If the coolant level drops within a short time of replenishing

Visually check the radiator, hoses, engine coolant reservoir cap, drain cock and water pump.

If you cannot find a leak, have any authorized Toyota dealer or repairer, or another duly qualified and equipped professional, test the cap and check for leaks in the cooling system.

CAUTION

■ When the engine is hot

Do not remove the radiator cap (gasoline engine), or the engine coolant reservoir cap (diesel engine).

The cooling system may be under pressure and may spray hot coolant if the cap is removed, causing serious injuries, such as burns.

NOTICE

■ When adding coolant

Coolant is neither plain water nor straight antifreeze. The correct mixture of water and antifreeze must be used to provide proper lubrication, corrosion protection and cooling. Be sure to read the antifreeze or coolant label.

■ If you spill coolant

Be sure to wash it off with water to prevent it from damaging parts or paint.

Radiator, condenser and intercooler

Check the radiator, condenser and intercooler and clear away any foreign objects.

If any of the above parts are extremely dirty or you are not sure of their condition, have your vehicle inspected by any authorized Toyota dealer or repairer, or another duly qualified and equipped professional.

CAUTION

■ When the engine is hot







Do not touch the radiator, condenser or intercooler as they may be hot and cause serious injuries, such as burns.

Battery

Check the battery as follows:

■ Caution symbols

The meanings of each caution symbol on the top of the battery are as follows:

	No smoking, no naked flames, no sparks		Battery acid
	Shield eyes		Note operating instructions
	Keep away from children		Explosive gas

■ Battery exterior

Make sure that the battery terminals are not corroded and that there are no loose connections, cracks, or loose clamps.

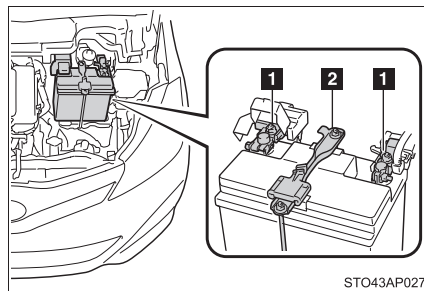

1 Terminals

2 Hold-down clamp

■ Before recharging

When recharging, the battery produces hydrogen gas which is flammable and explosive. Therefore, observe the following before recharging:

- If recharging with the battery installed on the vehicle, be sure to disconnect the ground cable.
- Make sure the power switch on the charger is off when connecting and disconnecting the charger cables to the battery.

■ After recharging/reconnecting the battery (vehicles with a smart entry & start system)

- Unlocking the doors using the smart entry & start system may not be possible immediately after reconnecting the battery. If this happens, use the wireless remote control or the mechanical key to lock/unlock the doors.
- Start the engine with the “ENGINE START STOP” switch in ACCESSORY mode. The engine may not start with the “ENGINE START STOP” switch turned off. However, the engine will operate normally from the second attempt.
- The “ENGINE START STOP” switch mode is recorded by the vehicle. If the battery is reconnected, the vehicle will return the “ENGINE START STOP” switch mode to the status it was in before the battery was disconnected. Make sure to turn off the engine before disconnect the battery. Take extra care when connecting the battery if the “ENGINE START STOP” switch mode prior to discharge is unknown.

If the engine will not start even after multiple attempts, contact any authorized Toyota dealer or repairer, or another duly qualified and equipped professional.

 CAUTION

■ **Chemicals in the battery**

Batteries contain poisonous and corrosive sulfuric acid and may produce hydrogen gas which is flammable and explosive. To reduce the risk of death or serious injury, take the following precautions while working on or near the battery:

- Do not cause sparks by touching the battery terminals with tools.
- Do not smoke or light a match near the battery.
- Avoid contact with eyes, skin and clothes.
- Never inhale or swallow electrolyte.
- Wear protective safety glasses when working near the battery.
- Keep children away from the battery.

■ **Where to safely charge the battery**

Always charge the battery in an open area. Do not charge the battery in a garage or closed room where there is insufficient ventilation.

■ **How to recharge the battery**

Only perform a slow charge (5 A or less). The battery may explode if charged at a quicker rate.

⚠ CAUTION**■ Emergency measures regarding electrolyte**

- If electrolyte gets in your eyes
Flush your eyes with clean water for at least 15 minutes and get immediate medical attention. If possible, continue to apply water with a sponge or cloth while traveling to the nearest medical facility.
- If electrolyte gets on your skin
Wash the affected area thoroughly. If you feel pain or burning, get medical attention immediately.
- If electrolyte gets on your clothes
It can soak through clothing on to your skin. Immediately take off the clothing and follow the procedure above if necessary.
- If you accidentally swallow electrolyte
Drink a large quantity of water or milk. Follow with milk of magnesia, beaten raw egg or vegetable oil. Get emergency medical attention immediately.

⚠ NOTICE**■ When recharging the battery**

Never recharge the battery while the engine is running. Also, be sure all accessories are turned off.

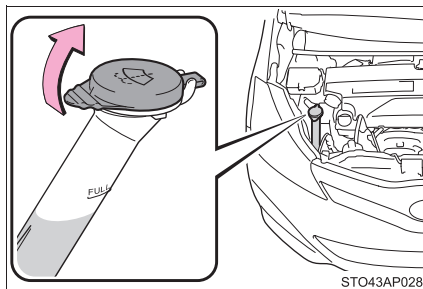
Washer fluid

If the washer fluid level is less than “FULL” line, add washer fluid to “FULL” line.

 CAUTION

■ **When adding washer fluid**

Do not add washer fluid when the engine is hot or running as washer fluid contains alcohol and may catch fire if spilled on the engine etc.

 NOTICE

■ **Do not use any fluid other than washer fluid**

Do not use soapy water or engine antifreeze instead of washer fluid.
Doing so may cause streaking on the vehicle's painted surfaces.

■ **Diluting washer fluid**

Dilute washer fluid with water as necessary.
Refer to the freezing temperatures listed on the washer fluid tank.

Fuel filter (diesel engine only)

You may drain the fuel filter yourself. However, as the operation is difficult, we recommend having it drained by any authorized Toyota dealer or repairer, or another duly qualified and equipped professional. Even if you decide to drain it yourself, contact any authorized Toyota dealer or repairer, or another duly qualified and equipped professional.

The water in the fuel filter needs to be drained if the fuel filter warning light comes on. (→P. 447)

STEP 1 Vehicles without a smart entry & start system:
Turn the engine switch to the “LOCK” position.

Vehicles with a smart entry & start system:
Turn the “ENGINE START STOP” switch off.

STEP 2 Place a small tray under the drain plug to catch the water and any fuel that comes out.

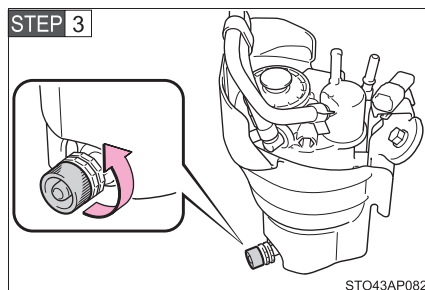

Turn the drain plug counterclockwise about 2 to 2 1/2 turns.

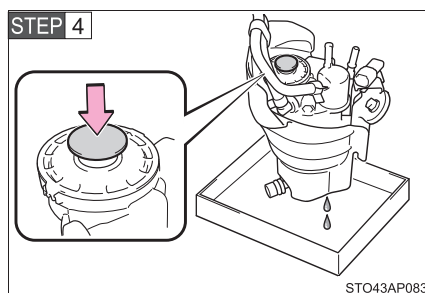

Operate the priming pump until fuel begins to run out.

STEP 5 After draining, tighten the drain plug by hand.

4-3. Do-it-yourself maintenance

Tires

Replace or rotate tires in accordance with maintenance schedules and treadwear.

■ Checking tires

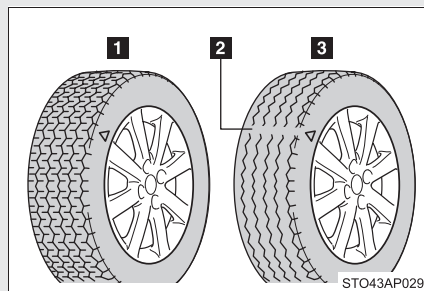

- 1 New tread
- 2 Treadwear indicator
- 3 Worn tread

The location of treadwear indicators is shown by the “TWI” or “Δ” marks, etc., molded on the sidewall of each tire.

Check spare tire condition and pressure if not rotated.

■ Tire rotation

Vehicles with a spare tire of different wheel type from the installed tires or an emergency tire puncture repair kit

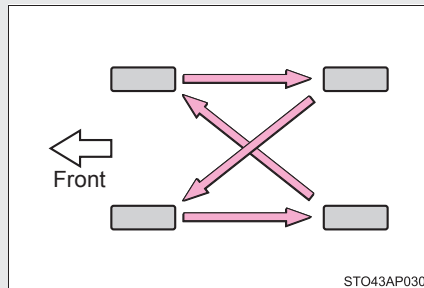

Rotate the tires in the order shown.

To equalize tire wear and help extend tire life, Toyota recommends that tire rotation is carried out approximately every 10000 km (6000 miles).

Vehicles with a spare tire of the same wheel type as the installed tires

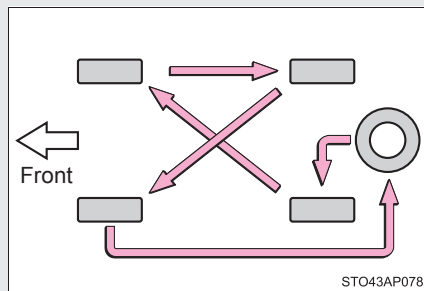

Rotate the tires in the order shown.

To equalize tire wear and help extend tire life, Toyota recommends that tire rotation is carried out approximately every 10000 km (6000 miles).

■ When to replace your vehicle's tires

Tires should be replaced if:

- You have tire damage such as cuts, splits, cracks deep enough to expose the fabric, and bulges indicating internal damage
- A tire goes flat repeatedly or cannot be properly repaired due to the size or location of a cut or other damage

If you are not sure, consult with any authorized Toyota dealer or repairer, or another duly qualified and equipped professional.

■ Tire life

Any tire over 6 years old must be checked by a qualified technician even if it has seldom or never been used or damage is not obvious.

■ Low profile tires (vehicles with 195/50R16 tires)

Generally, low profile tires will wear more rapidly and tire grip performance will be reduced on snowy and/or icy roads when compared to standard tires. Be sure to use snow tires or tire chains on snowy and/or icy roads and drive carefully at a speed appropriate for road and weather conditions.

■ If the tread on snow tires wears down below 4 mm (0.16 in.)

The effectiveness of the tires as snow tires is lost.

 CAUTION

■ **When inspecting or replacing tires**

Observe the following precautions to prevent accidents.
Failure to do so may cause damage to parts of the drive train as well as dangerous handling characteristics, which may lead to an accident resulting in death or serious injury.

- Do not mix tires of different makes, models or tread patterns.
Also, do not mix tires of remarkably different treadwear.
- Do not use tire sizes other than those recommended by Toyota.
- Do not mix differently constructed tires (radial, bias-belted or bias-ply tires).
- Do not mix summer, all season and snow tires.
- Do not use tires that have been used on another vehicle.
Do not use tires if you do not know how they were used previously.
- Vehicles with a compact spare tire: Do not tow if your vehicle has a compact spare tire installed.

 NOTICE**■ Driving on rough roads**

Take particular care when driving on roads with loose surfaces or potholes. These conditions may cause losses in tire inflation pressure, reducing the cushioning ability of the tires. In addition, driving on rough roads may cause damage to the tires themselves, as well as the vehicle's wheels and body.

■ Low profile tires (vehicles with 195/50R16 tires)

Low profile tires may cause greater damage than usual to the tire wheel when sustaining impact from the road surface. Therefore, pay attention to the following:

- Be sure to use proper tire inflation pressure. If tires are under-inflated, they may be damaged more severely.
- Avoid potholes, uneven pavement, curbs and other road hazards. Failure to do so may lead to severe tire and wheel damage.

■ If tire inflation pressure of each tire becomes low while driving

Do not continue driving, or your tires and/or wheels may be ruined.

4-3. Do-it-yourself maintenance

Tire inflation pressure

Make sure to maintain proper tire inflation pressure. Tire inflation pressure should be checked at least once per month. However, Toyota recommends that tire inflation pressure be checked once every two weeks. (→P. 533)

■ Effects of incorrect tire inflation pressure

Driving with incorrect tire inflation pressure may result in the following:

- Reduced fuel efficiency
- Reduced driving comfort and tire life
- Reduced safety
- Damage to the drive train

If a tire needs frequent inflating, have it checked by any authorized Toyota dealer or repairer, or another duly qualified and equipped professional.

■ Instructions for checking tire inflation pressure

When checking tire inflation pressure, observe the following:

- Check only when the tires are cold.
If your vehicle has been parked for at least 3 hours or has not been driven for more than 1.5 km or 1 mile, you will get an accurate cold tire inflation pressure reading.
- Always use a tire pressure gauge.
The appearance of the tire can be misleading. In addition, tire inflation pressure that is even just a few pounds off can affect ride quality and handling.
- Do not reduce tire inflation pressure after driving. It is normal for tire inflation pressure to be higher after driving.
- Never exceed the vehicle capacity weight.
Passengers and luggage weight should be placed so that the vehicle is balanced.

 CAUTION**■ Proper inflation is critical to save tire performance**

Keep your tires properly inflated. Otherwise, the following conditions may occur and result in an accident causing death or serious injury:

- Excessive wear
- Uneven wear
- Poor handling
- Possibility of blowouts resulting from overheated tires
- Poor sealing of the tire bead
- Wheel deformation and/or tire separation
- A greater possibility of tire damage from road hazards

 NOTICE**■ When inspecting and adjusting tire inflation pressure**

Be sure to put the tire valve caps back on.

Without the valve caps, dirt or moisture could get into the valve and cause air leakage, which could result in an accident. If the caps are lost, replace them as soon as possible.

4-3. Do-it-yourself maintenance

Wheels

If a wheel is bent, cracked or heavily corroded, it should be replaced. Otherwise, the tire may separate from the wheel or cause a loss of handling control.

■ Wheel selection

When replacing wheels, care should be taken to ensure that they are equivalent to those removed in load capacity, diameter, rim width and inset*.

Replacement wheels are available at any authorized Toyota dealer or repairer, or another duly qualified and equipped professional.

*: Conventionally referred to as "offset".

Toyota does not recommend using the following:

- Wheels of different sizes or types
- Used wheels
- Bent wheels that have been straightened

■ Aluminum wheel precautions (if equipped)

- Use only Toyota wheel nuts and wrenches designed for use with your aluminum wheels.
- When rotating, repairing or changing your tires, check that the wheel nuts are still tight after driving 1600 km (1000 miles).
- Be careful not to damage the aluminum wheels when using tire chains.
- Use only Toyota genuine balance weights or equivalent and use a plastic or rubber hammer when balancing your wheels.

⚠ CAUTION

■ **When replacing wheels**

- Do not use wheels that are a different size from those recommended in the Owner's Manual, as this may result in a loss of handling control.
- Never use an inner tube in a leaking wheel which is designed for a tubeless tire. Doing so may result in an accident, causing death or serious injury.

■ **When installing the wheel nuts**

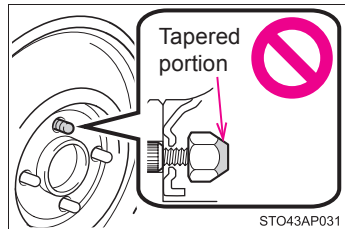

- Be sure to install the wheel nuts with the tapered end facing inward. Installing the nuts with the tapered end facing outward can cause wheel to break and eventually cause a wheel to come off while driving, which could lead to an accident resulting in death or serious injury.

- Never use oil or grease on the wheel bolts or wheel nuts. Oil and grease may cause the wheel nuts to be excessively tightened, leading to bolt or disc wheel damage. In addition, the oil or grease can cause the wheel nuts to loosen and the wheel may fall off, causing an accident and resulting in death or serious injury. Remove any oil or grease from the wheel bolts or wheel nuts.

4-3. Do-it-yourself maintenance

Air conditioning filter

The air conditioning filter must be changed regularly to maintain air conditioning efficiency.

■ Replacement method

- STEP 1** Vehicles without a smart entry & start system:
The engine switch is in the "LOCK" position.
Vehicles with a smart entry & start system:
The "ENGINE START STOP" switch off.

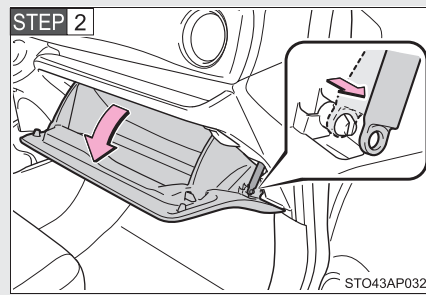

Open the glove box. Slide off the damper.

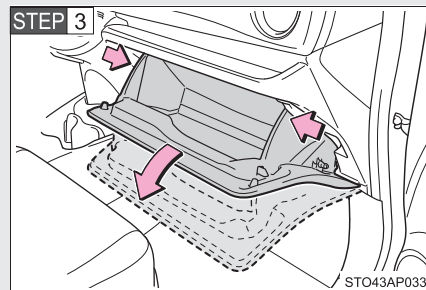

Push in each side of the glove box to disconnect the upper claws.

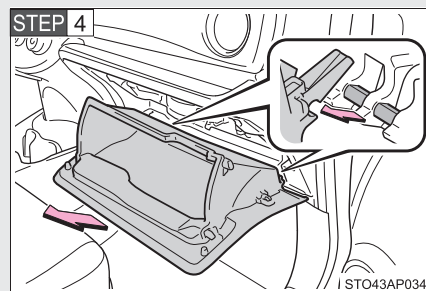

Pull out the glove box and disconnect the lower claws.

STEP 5 Remove the filter cover.

Left hand drive vehicles

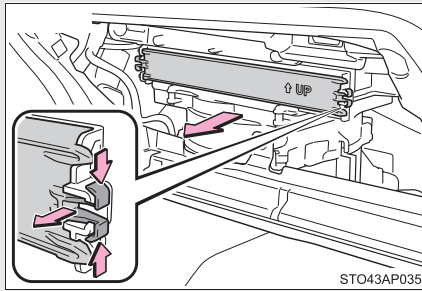

Right hand drive vehicles

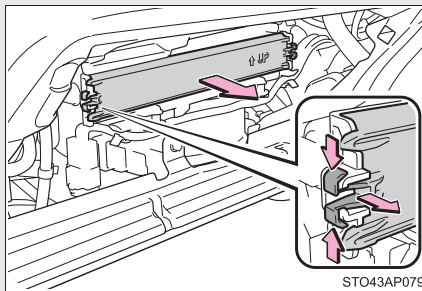

STEP 6

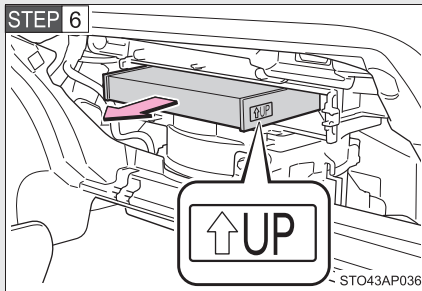

Remove the air conditioning filter and replace it with a new one.

The "↑UP" marks shown on the filter should be pointing up.

■ **Checking interval**

Inspect and replace the air conditioning filter according to the maintenance schedule. In dusty areas or areas with heavy traffic flow, early replacement may be required. (For scheduled maintenance information, please refer to the “Toyota Service Booklet” or “Toyota Warranty Booklet”.)

■ **If air flow from the vents decreases dramatically**

The filter may be clogged. Check the filter and replace if necessary.

 **NOTICE**

■ **When using the air conditioning system**

Make sure that a filter is always installed.
Using the air conditioning system without a filter may cause damage to the system.

4-3. Do-it-yourself maintenance

Wireless remote control/electronic key battery

Replace the battery with a new one if it is depleted.

■ You will need the following items:

- Flathead screwdriver
- Lithium battery CR2016 (vehicles without a smart entry & start system), or CR2032 (vehicles with a smart entry & start system)

■ Replacing the battery (vehicles without a smart entry & start system)

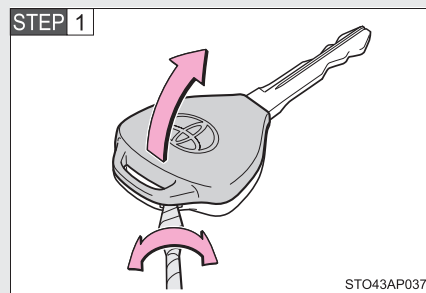

Remove the cover.

To prevent damage to the key, cover the tip of the screwdriver with a tape.

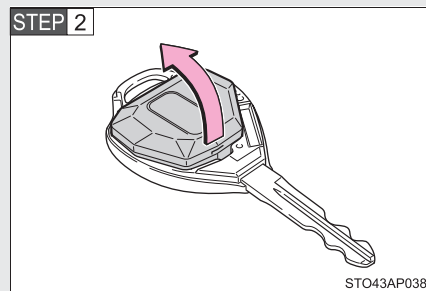

Remove the module.

4-3. Do-it-yourself maintenance

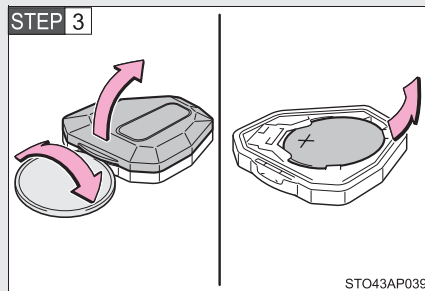

Remove the battery cover and the depleted battery.

Insert a new battery with the "+" terminal facing up.

■ Replacing the battery (vehicles with a smart entry & start system)

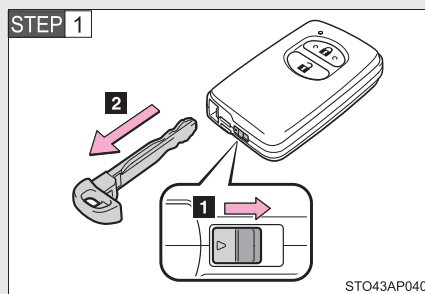

Take out the mechanical key.

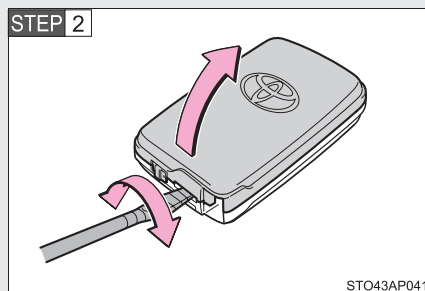

Remove the cover.

To prevent damage to the key, cover the tip of the screwdriver with a tape.

STEP 3

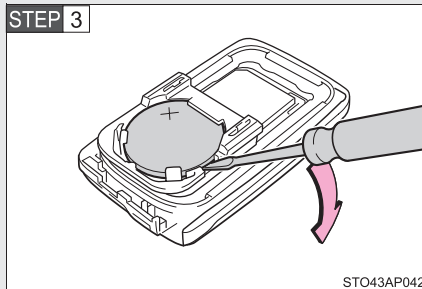

Remove the depleted battery.

Insert a new battery with the "+" terminal facing up.

■ **Use a CR2016 (vehicles without a smart entry & start system) or CR2032 (vehicles with a smart entry & start system) lithium battery**

- Batteries can be purchased at any authorized Toyota dealer or repairer, or another duly qualified and equipped professional, local electrical appliance shops or camera stores.
- Replace only with the same or equivalent type recommended by the manufacturer.
- Dispose of used batteries according to local laws.

■ **If the key battery is depleted**

The following symptoms may occur:

- The smart entry & start system (if equipped) and wireless remote control will not function properly.
- The operational range will be reduced.

 CAUTION

■ **Removed battery and other parts**

Keep away from children. These parts are small and if swallowed by a child, they can cause choking. Failure to do so could result in death or serious injury.

■ **Certification for the lithium battery**

RISK OF EXPLOSION IF BATTERY IS REPLACED BY AN INCORRECT TYPE. DISPOSE OF USED BATTERIES ACCORDING TO THE INSTRUCTIONS

 NOTICE

■ **For normal operation after replacing the battery**

Observe the following precautions to prevent accidents:

- Always work with dry hands.
Moisture may cause the battery to rust.
- Do not touch or move any other component inside the remote control.
- Do not bend either of the battery terminals.

4-3. Do-it-yourself maintenance

Checking and replacing fuses

If any of the electrical components do not operate, a fuse may have blown. If this happens, check and replace the fuses as necessary.

- STEP 1** Vehicles without a smart entry & start system:
Turn the engine switch is in the “LOCK” position.
Vehicles with a smart entry & start system:
Turn the “ENGINE START STOP” switch off.

STEP 2 Open the fuse box cover.

Engine compartment (type A fuse box)

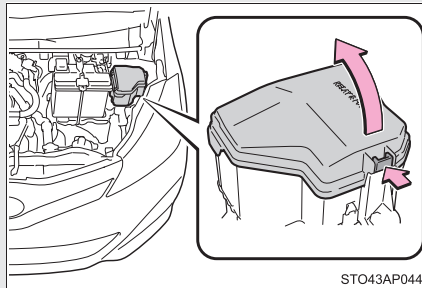

Push the tab in and lift the lid off.

Engine compartment (type B fuse box)

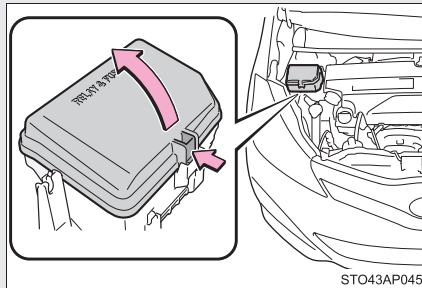

Push the tab in and lift the lid off.

Engine compartment (type C fuse box for the left-hand drive vehicles)

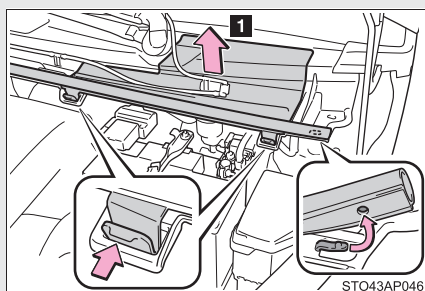

1 Pull the rubber strip on the edge to unhook it from the cover, and then push the tabs in and lift the cover off.

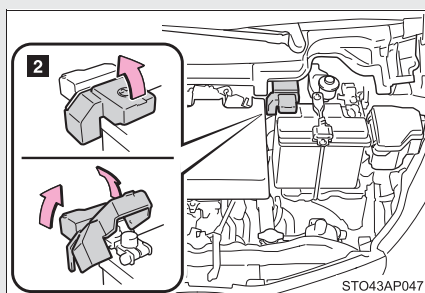

2 Remove the battery terminal cover and then the fuse box cover.

Engine compartment (type C fuse box for the right-hand drive vehicles)

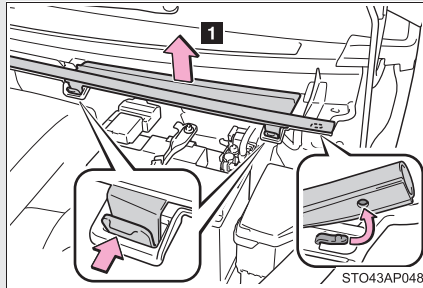

1 Pull the rubber strip on the edge to unhook it from the cover, and then push the tabs in and lift the cover off.

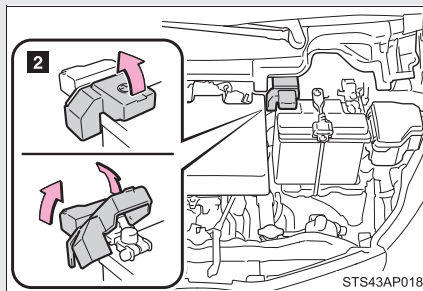

2 Remove the battery terminal cover and then the fuse box cover.

4-3. Do-it-yourself maintenance

Under the instrument panel (left-hand drive vehicles)

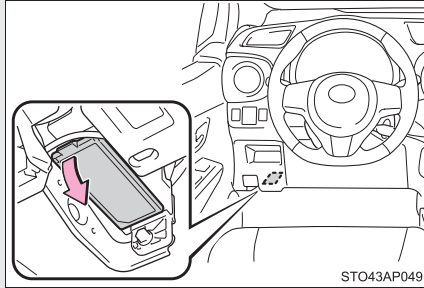

Remove the lid.

Under the instrument panel (right-hand drive vehicles)

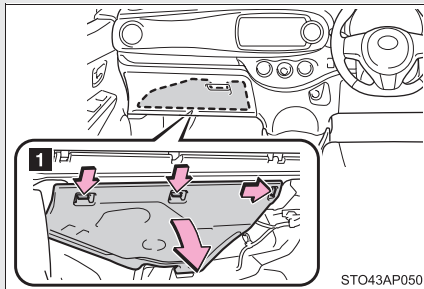

1 Remove the cover.

Do not pull off the cover using excessive force as it is attached to the footwell light.

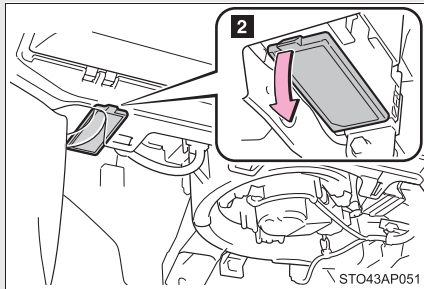

2 Remove the lid.

STEP 3 After a system failure, see “Fuse layout and amperage ratings” (→P. 412) for details about which fuse to check.

STEP 4 Remove the fuse.

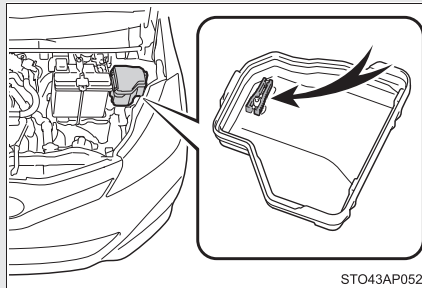

STO43AP052

Only type A fuse can be removed using the pullout tool.

The pullout tool is located on the back of the type A fuse box cover.

STEP 5 Check if the fuse is blown.

Type A

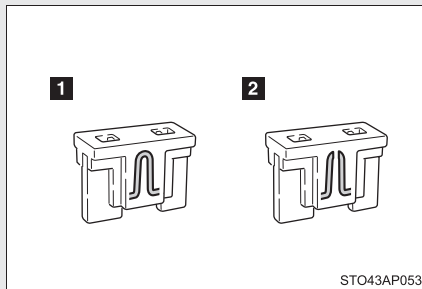

STO43AP053

1 Normal fuse

2 Blown fuse

Replace the blown fuse with a new fuse of an appropriate amperage rating. The amperage rating can be found on the fuse box lid.

Type B

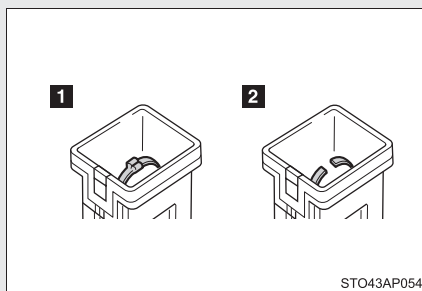

STO43AP054

1 Normal fuse

2 Blown fuse

Replace the blown fuse with a new fuse of an appropriate amperage rating. The amperage rating can be found on the fuse box lid.

Type C

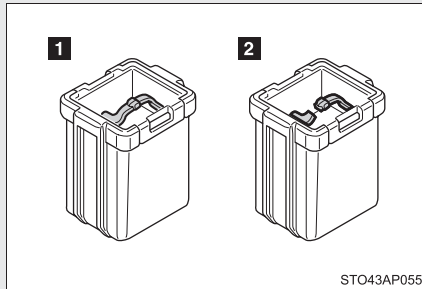

STO43AP055

1 Normal fuse

2 Blown fuse

Replace the blown fuse with a new fuse of an appropriate amperage rating. The amperage rating can be found on the fuse box lid.

Type D

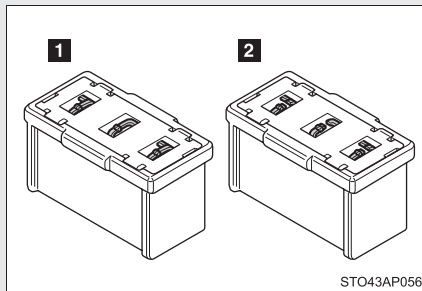

STO43AP056

1 Normal fuse

2 Blown fuse

Replace the blown fuse with a new fuse of an appropriate amperage rating. The amperage rating can be found on the fuse box lid.

Type E

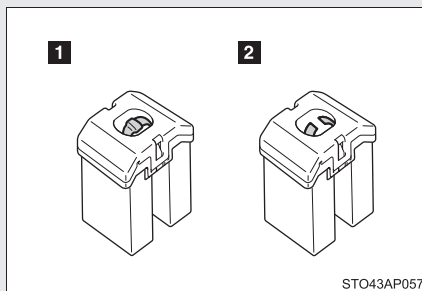

STO43AP057

1 Normal fuse

2 Blown fuse

Replace the blown fuse with a new fuse of an appropriate amperage rating. The amperage rating can be found on the fuse box lid.

Type F

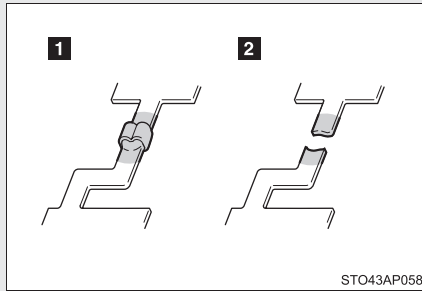

1 Normal fuse

2 Blown fuse

Contact any authorized Toyota dealer or repairer, or another duly qualified and equipped professional.

Fuse layout and amperage ratings

Engine compartment (type A fuse box)

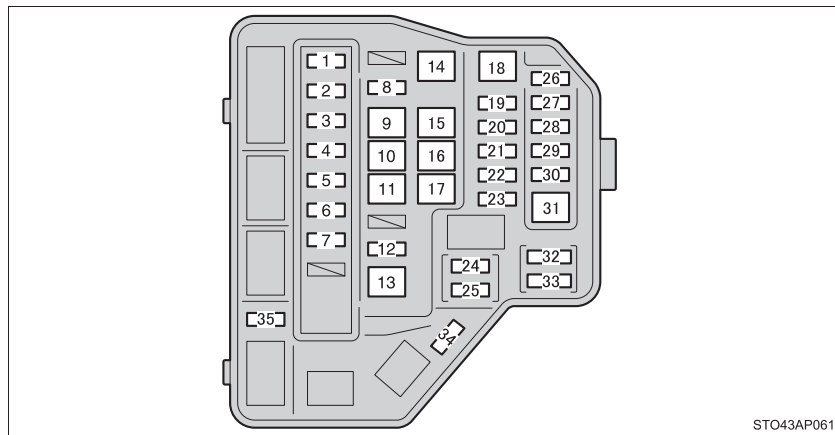

	Fuse	Ampere	Circuit
1	EFI MAIN* ¹	20 A	Multiport fuel injection system/ sequential multiport fuel injection system, EFI NO.2, EFI NO.3
	ECD MAIN* ²	30 A	Multiport fuel injection system/ sequential multiport fuel injection system, EFI NO.2, EFI NO.3
2	EFI NO.3	7.5 A	Multiport fuel injection system/ sequential multiport fuel injection system
3	HORN	10 A	Horn
4	EFI NO.2	10 A	Stop & Start system, multiport fuel injection system/sequential multi- port fuel injection system

Fuse		Ampere	Circuit
5	IG2	10 A	Smart entry & start system, multiport fuel injection system/sequential multiport fuel injection system, multi-mode manual transmission, SRS airbag system, steering lock system, stop lights, Stop & Start system
6	IGN	15 A	Multiport fuel injection system/sequential multiport fuel injection system
7	MET	7.5 A	Gauge and meters, Stop & Start system
8	PWR HTR* ²	25 A	Power heater, multiport fuel injection system/sequential multiport fuel injection system
9	EPS	50 A	Electric power steering
10	ABS NO.2	30 A	ABS, VSC
11	DEF	30 A	Rear window defogger, ID/UP, MIR-HTR
12	SPARE	10 A	Spare fuse
13	PTC	80 A	PTC heater
14	HTR	40 A	Air conditioning system
15	H-LP CLN	30 A	—
16	RDI FAN	30 A	Electric cooling fan
17	ABS NO.1	50 A	ABS, VSC
18	BBC* ³	40 A	Stop & Start system
19	ST	30 A	Starting system
20	AMP	30 A	Audio system
21	D/L NO.2	25 A	Power door lock
22	D.C.C.	30 A	DOME, ECU-B NO.1
23	STR LOCK	20 A	Steering lock system

4-3. Do-it-yourself maintenance

Fuse		Ampere	Circuit
24	ECU-B NO.1	5 A	Main body ECU, smart entry & start system
25	DOME	15 A	Interior lights, audio system, VSC
26	ETCS	10 A	Multiport fuel injection system/ sequential multiport fuel injection system
27	HAZ	10 A	Turn signal lights
28	AM2	7.5 A	Multiport fuel injection system/ sequential multiport fuel injection system, smart entry & start system, stop & start system, starting system, multi-mode manual transmission
29	ECU-B NO.2	5 A	Gauge and meters, power door lock, wireless remote control, Stop & Start system, smart entry & start system, multi-mode manual transmission, air conditioning system
30	ALT-S	7.5 A	—
31	R/I	50 A	EFI MAIN, ECD MAIN, EFI NO.2, EFI NO.3, IG2, IGN, MET, HORN
32	SPARE	20 A	Spare fuse
33	SPARE	30 A	Spare fuse
34	MIR-HTR	10 A	Outside rear view mirror defogger
35	ID/UP	7.5 A	Multiport fuel injection system/ sequential multiport fuel injection system

*1: Gasoline engine

*2: Diesel engine

*3: Vehicles with a 1NR-FE engine equipped with a Stop & Start system

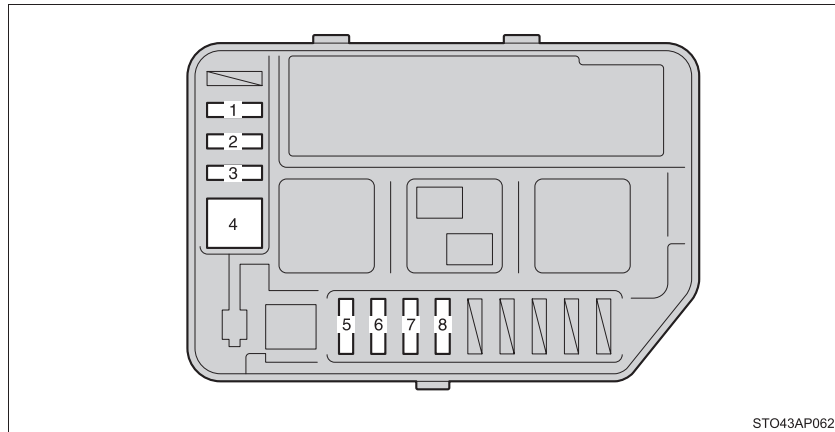
Engine compartment (type B fuse box)

Fuse		Ampere	Circuit
1	EU-DRL	15 A	—
2	S-HORN	10 A	—
3	H-LP MAIN	7.5 A	Headlights
4	MMT	50 A	Multi-mode manual transmission
5	H-LP RH HI	10 A	Right-hand headlight (high beam)
6	H-LP LH HI	10 A	Left-hand headlight (high beam), gauge and meters
7	H-LP RH LO	10 A	Right-hand headlight (low beam)
8	H-LP LH LO	10 A	Left-hand headlight (low beam), manual headlight leveling dial

Engine compartment (gasoline engine type C fuse box)

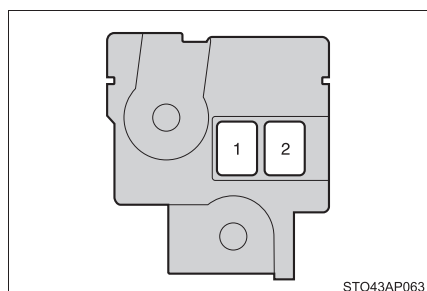

Fuse		Ampere	Circuit
1	ALT	120 A	EPS, ABS NO.2, DEF, PTC, HTR, RDI FAN, ABS NO.1, TAIL NO.2, PANEL, DOOR R/R, DOOR P, ECU-IG NO.1, ECU-IG NO.2, A/C, GAUGE, WASHER, WIPER, WIPER RR, P/W, DOOR R/L, DOOR, CIG, ACC, D/L, OBD, FOG RR, STOP, AM1, FOG FR, D-D/L, SHADE, S-HTR
2	MAIN	80 A	BBC, ST, D/L NO.2, D.C.C., STR LOCK, ETCS, HAZ, AM2, ECU-B NO.2, R/I, H-LP MAIN, H-LP RH HI, H-LP LH HI, H-LP RH LO, H-LP LH LO, AMP

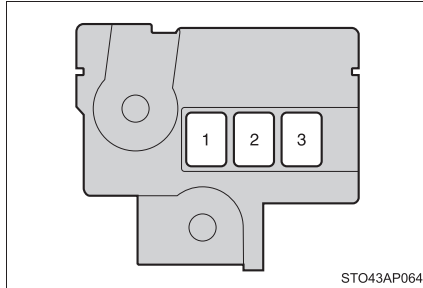
Engine compartment (diesel engine type C fuse box)

Fuse		Ampere	Circuit
1	ALT	120 A	PWR HTR, EPS, ABS NO.2, DEF, PTC, HTR, RDI FAN, ABS NO.1, TAIL NO.2, PANEL, DOOR R/R, DOOR P, ECU-IG NO.1, ECU-IG NO.2, A/C, GAUGE, WASHER, WIPER, WIPER RR, P/W, DOOR R/L, DOOR, CIG, ACC, D/L, OBD, FOG RR, STOP, AM1, FOG FR, D-D/L, SHADE, S-HTR
2	MAIN	80 A	ST, D/L NO.2, D.C.C., STR LOCK, ETCS, HAZ, AM2, ECU-B NO.2, R/I, H-LP MAIN, H-LP RH HI, H-LP LH HI, H-LP RH LO, H-LP LH LO, MMT
3	GLOW DC/DC	80 A	Engine glow system

Under the instrument panel

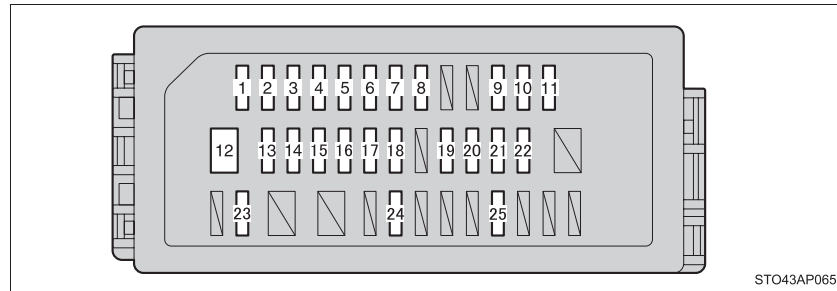

Fuse		Ampere	Circuit
1	TAIL NO.2	10 A	Front position lights, tail lights, license plate lights, front fog lights, rear fog light, multiport fuel injection system/sequential multiport fuel injection system, gauge and meters
2	PANEL	5 A	Gauge and meters, instrument panel lights, switch illumination
3	DOOR R/R	20 A	Power windows
4	DOOR P	20 A	Power windows
5	ECU-IG NO.1	5 A	Electric cooling fan, rear window defogger, electric power steering, main body ECU, windshield wipers, VSC
6	ECU-IG NO.2	5 A	ABS, VSC, Stop & Start system
7	A/C	7.5 A	Air conditioning system, power heater, rear window defogger, outside rear view mirror defoggers
8	GAUGE	10 A	Back-up lights, shift lock control system, rear seat belt reminder lights, auto anti-glare inside rear view mirror, multidrive, audio system, multiport fuel injection system/sequential multiport fuel injection system, rain sensor

Fuse		Ampere	Circuit
9	WASHER	15 A	Windshield washer
10	WIPER	20 A	Windshield wipers
11	WIPER RR	15 A	Rear window wiper
12	P/W	30 A	Power windows
13	DOOR R/L	20 A	Power windows
14	DOOR	20 A	Power windows
15	CIG	15 A	Power outlets
16	ACC	5 A	Main body ECU, outside rear view mirrors, audio system, Stop & Start system, shift lock control system
17	D/L	25 A	Power door lock system
18	OBD	7.5 A	On-board diagnosis system
19	FOG RR	7.5 A	Rear fog light, gauge and meters
20	STOP	7.5 A	Multiport fuel injection system/ sequential multiport fuel injection system, smart entry & start system, ABS, VSC, stop lights, high mounted stoplight, shift lock control system
21	AM1	7.5 A	Starting system
22	FOG FR	15 A	Front fog lights, gauge and meters
23	D-D/L	25 A	D-D/L
24	SHADE	25 A	—
25	S-HTR	15 A	Seat heaters

■ **After a fuse is replaced**

- If the lights do not turn on even after the fuse has been replaced, a bulb may need replacement. (→P. 422)
- If the replaced fuse blows again, have the vehicle inspected by any authorized Toyota dealer or repairer, or another duly qualified and equipped professional.

■ **If there is an overload in a circuit**

The fuses are designed to blow, protecting the wiring harness from damage.

■ **When replacing light bulbs**

Toyota recommends that you use genuine Toyota products designed for this vehicle. Because certain bulbs are connected to circuits designed to prevent overload, non-genuine parts or parts not designed for this vehicle may be unusable.

■ **When reinstalling the cover (type C fuse box cover only)**

Left hand drive vehicles

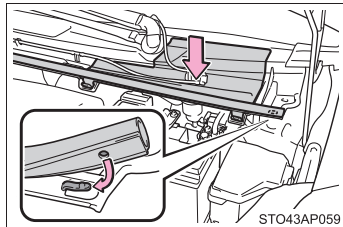

Reinstall the cover, and then hook the rubber strip's groove onto the cover.

Right hand drive vehicles

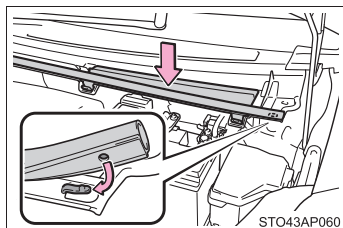

 CAUTION

■ **To prevent system breakdowns and vehicle fire**

Observe the following precautions.

Failure to do so may cause damage, and possibly a fire or injury.

- Never use a fuse of a higher amperage rating than that indicated, or use any other object in place of a fuse.
- Always use a genuine Toyota fuse or equivalent.
Never replace a fuse with a wire, even as a temporary fix.
This can cause extensive damage or even fire.
- Do not modify the fuses or fuse boxes.

 NOTICE

■ **Before replacing fuses**

Have the cause of electrical overload determined and repaired by any authorized Toyota dealer or repairer, or another duly qualified and equipped professional as soon as possible.

4-3. Do-it-yourself maintenance

Light bulbs

You may replace the following bulbs by yourself. The difficulty level of replacement varies depending on the bulb. As there is a danger that components may be damaged, we recommend that replacement is carried out by any authorized Toyota dealer or repairer, or another duly qualified and equipped professional.

For more information about replacing other light bulbs, contact any authorized Toyota dealer or repairer, or another duly qualified and equipped professional.

■ Preparing for light bulb replacement

Check the wattage of the light bulb to be replaced. (→P. 538)

■ Front bulb locations

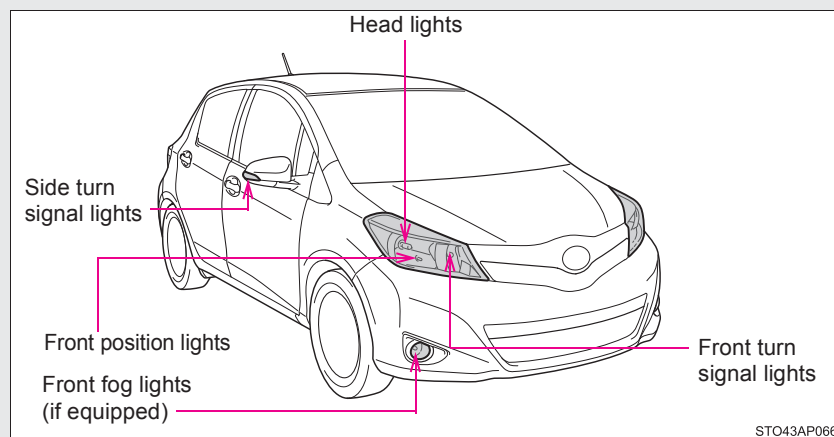

■ Rear bulb locations

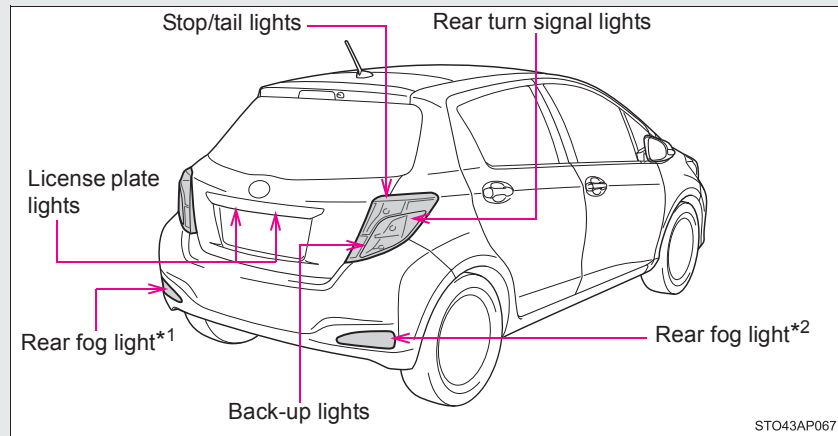

*1: Left-hand drive vehicles
*2: Right-hand drive vehicles

Replacing light bulbs

■ Headlights

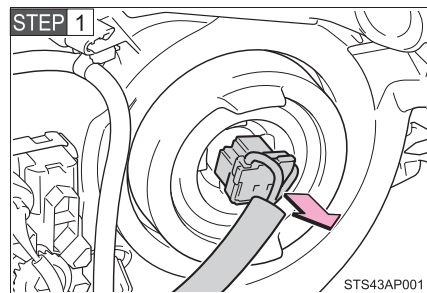

Unplug the connector.

4-3. Do-it-yourself maintenance

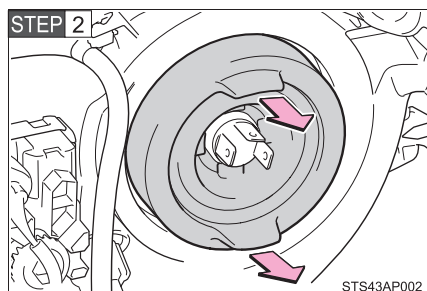

Remove the rubber cover.

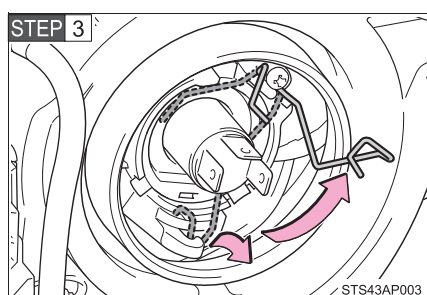

Release the bulb retaining spring.

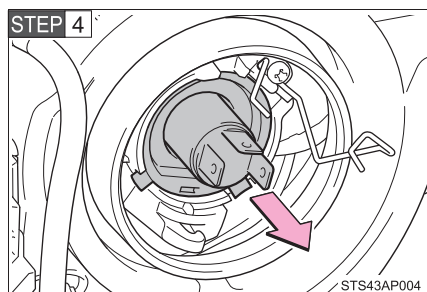

Remove the bulb.

To install a new bulb, align the tabs of the bulb with the cutouts of the mounting hole.

■ Front fog lights (if equipped)

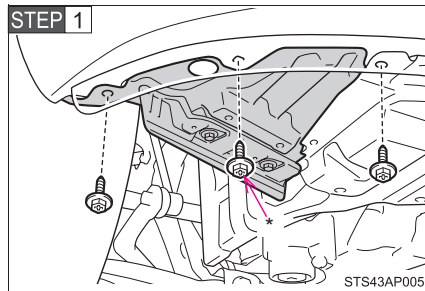

Vehicles without a front spoiler

Remove the 2 screws.

Vehicles with a front spoiler

Remove the 3 screws.

The front spoiler will come off on that side when the screws are removed.

*: Vehicles with a front spoiler only

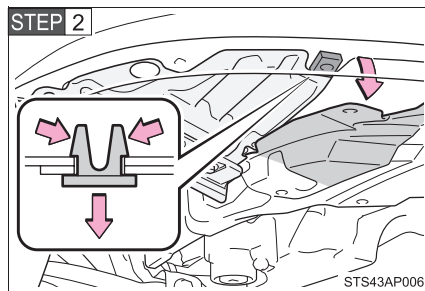

Remove the grommet.

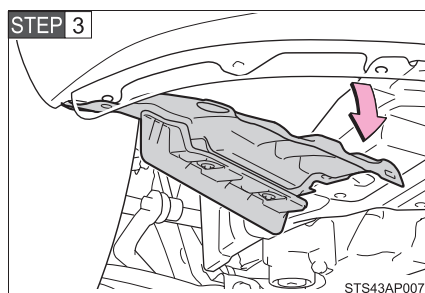

Partly remove the fender liner.

4-3. Do-it-yourself maintenance

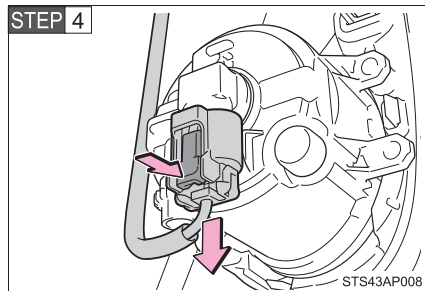

Unplug the connector while depressing the lock release.

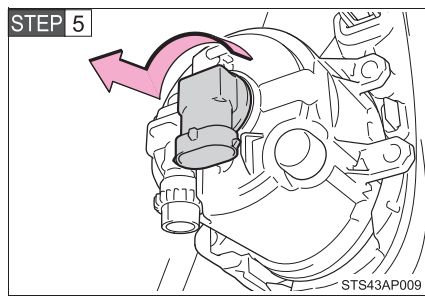

Turn the bulb base counterclockwise.

■ Front position lights

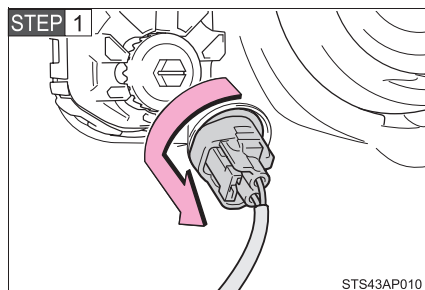

Turn the bulb base counterclockwise.

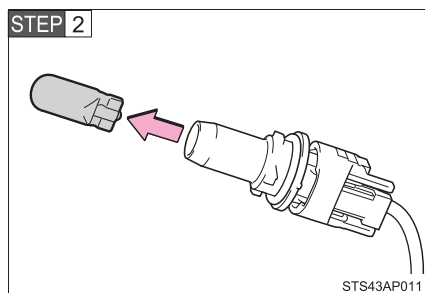

Remove the light bulb.

■ Front turn signal lights

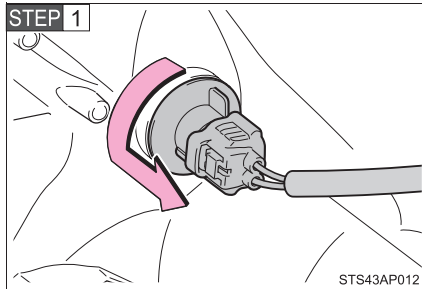

Turn the bulb base counterclockwise.

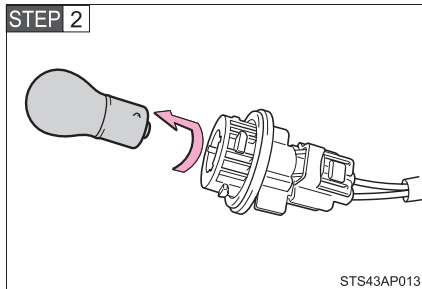

Remove the light bulb.

■ Side turn signal lights

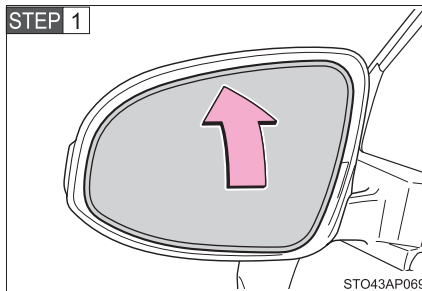

Depress the mirror.

4-3. Do-it-yourself maintenance

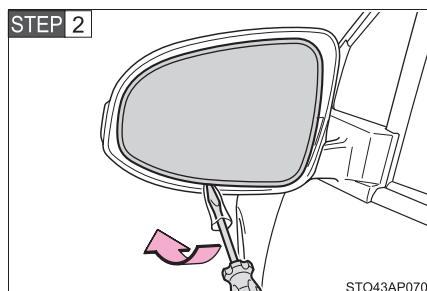

Remove the mirror.

To prevent damaging the vehicle,
wrap the screwdriver with a tape.

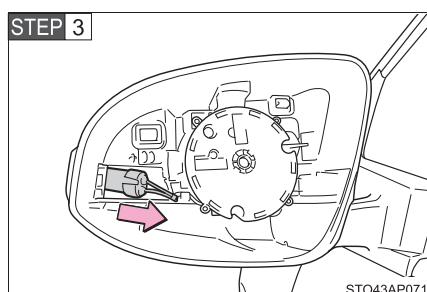

Remove the bulb base.

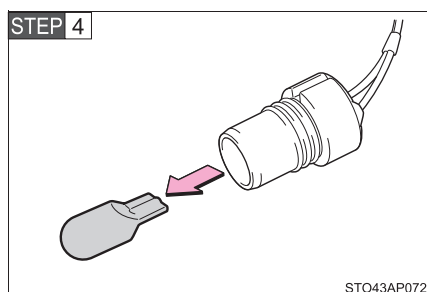

Remove the light bulb.

■ Back-up lights, stop/tail lights and rear turn signal lights

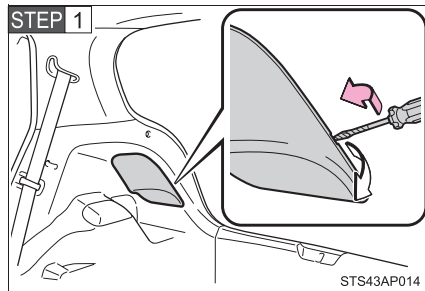

Open the back door and remove the cover.

To prevent damaging the vehicle, wrap the screwdriver with a tape.

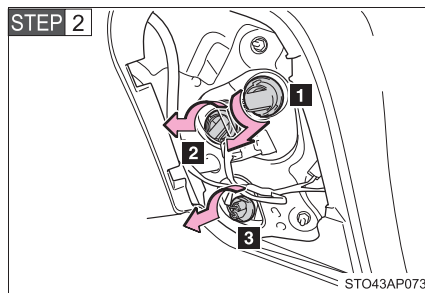

Turn the bulb base counterclockwise.

- 1 Stop/tail light
- 2 Rear turn signal light
- 3 Back-up light

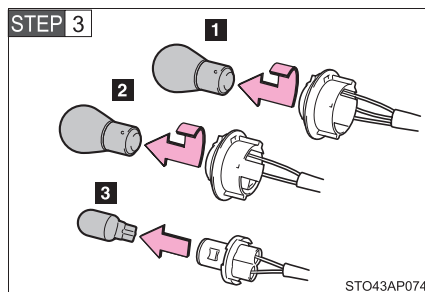

Remove the light bulb.

- 1 Stop/tail light
- 2 Rear turn signal light
- 3 Back-up light

■ Rear fog light

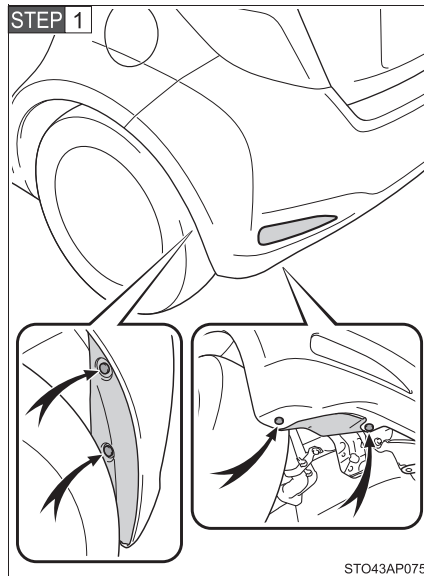

Remove the clips and remove the cover.

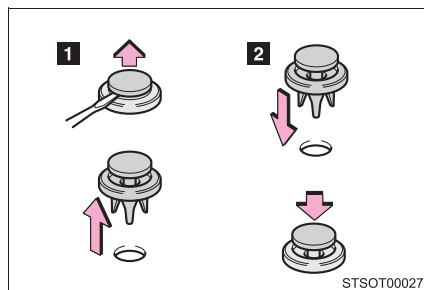

1 Remove the clips.
2 Insert the clips.

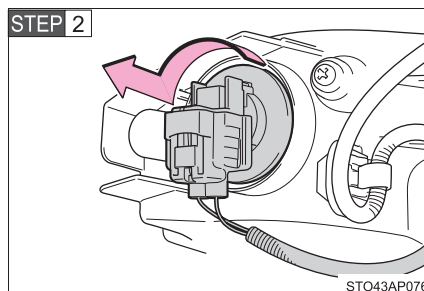

Turn the bulb base counterclockwise.

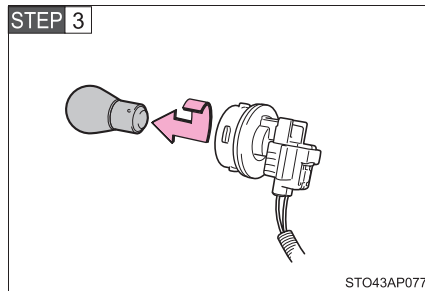

Remove the light bulb.

■ License plate lights

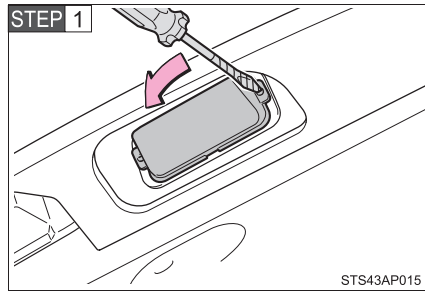

Remove the cover.

Insert a properly sized screwdriver into the hole of the cover, and pry off the cover as shown in the illustration.

To prevent damaging the vehicle, wrap the screwdriver with a tape.

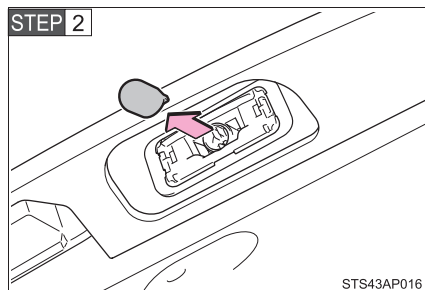

Remove the light bulb.

■ Replacing the following lights

If any of the lights listed below has burnt out, have it replaced by any authorized Toyota dealer or repairer, or another duly qualified and equipped professional.

- High mounted stoplight

■ **LED light bulbs**

The high mounted stoplight consists of a number of LEDs. If any of the LEDs burn out, take your vehicle to any authorized Toyota dealer or repairer, or another duly qualified and equipped professional to have the light replaced.

■ **Condensation build-up on the inside of the lens**

Contact any authorized Toyota dealer or repairer, or another duly qualified and equipped professional for more information in the following situations. Temporary condensation build-up on the inside of the headlight lens does not indicate a malfunction.

- Large drops of water have built up on the inside of the lens.
- Water has built up inside the headlight.

■ **When replacing light bulbs**

→P. 420

 **CAUTION**

■ **Replacing light bulbs**

- Turn off the lights. Do not attempt to replace the bulb immediately after turning off the lights.
The bulbs become very hot and may cause burns.
- Do not touch the glass portion of the light bulb with bare hands. Hold the bulb by the plastic or metal portion.
If the bulb is scratched or dropped, it may blow out or crack.
- Fully install light bulbs and any parts used to secure them. Failure to do so may result in heat damage, fire, or water entering the headlight unit. This may damage the headlights or cause condensation to build up on the lens.

■ **To prevent damage or fire**

Make sure bulbs are fully seated and locked.

When trouble arises

5

5-1. Essential information

Emergency flashers	434
If your vehicle needs to be towed	435
If you think something is wrong	442
Fuel pump shut off system (gasoline engine only)	443

5-2. Steps to take in an emergency

If a warning light turns on or a warning buzzer sounds	444
If you have a flat tire (vehicles with a spare tire)	459
If you have a flat tire (vehicles with an emergency tire puncture repair kit)	471
If the engine will not start	488
If the shift lever cannot be shifted from P (vehicles with a Multidrive)	491
If the shift lever cannot be shifted (vehicles with a multi-mode manual transmission)	492

If you lose your keys	493
If the electronic key does not operate properly (vehicles with a smart entry & start system)	494
If the vehicle battery is discharged	498
If your vehicle overheats ...	505
If you run out of fuel and the engine stalls (diesel engine only)	509
If the vehicle becomes stuck	512
If your vehicle has to be stopped in an emergency	514

5-1. Essential information

Emergency flashers

Use the emergency flashers if the vehicle malfunctions or is involved in an accident.

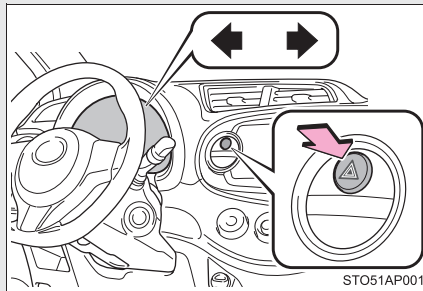

Press the switch to flash all the turn signal lights. To turn them off, press the switch once again.

NOTICE

■ To prevent battery discharge

Do not leave the emergency flashers on longer than necessary when the engine is not running.

5-1. Essential information

If your vehicle needs to be towed

If towing is necessary, we recommend having your vehicle towed by any authorized Toyota dealer or repairer, or another duly qualified and equipped professional, such as a commercial towing service, using a lift-type truck or flatbed truck.

Use a safety chain system for all towing, and abide by all state/provincial and local laws.

Before towing

The following may indicate a problem with your transmission. Contact any authorized Toyota dealer or repairer, or another duly qualified and equipped professional before towing.

- The engine is running but the vehicle will not move.
- The vehicle makes an abnormal sound.

Emergency towing

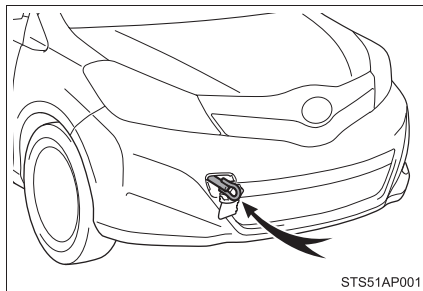

If a tow truck is not available in an emergency, your vehicle may be temporarily towed using a cable or chain secured to the emergency towing eyelet. This should only be attempted on hard surfaced roads for short distances at low speeds.

A driver must be in the vehicle to steer and operate the brakes. The vehicle's wheels, drive train, axles, steering and brakes must be in good condition.

Installing towing eyelet

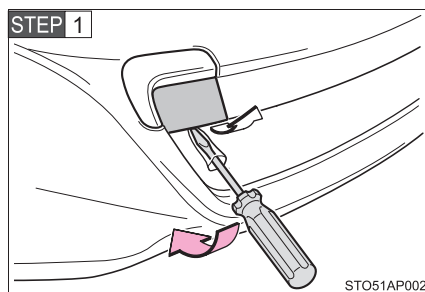

Remove the eyelet cover using a flathead screwdriver.

To protect the bodywork, place a rag between the screwdriver and the vehicle body as shown in the illustration.

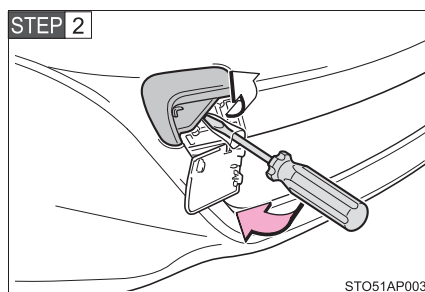

Remove the eyelet cover using a flathead screwdriver.

To protect the bodywork, place a rag between the screwdriver and the vehicle body as shown in the illustration.

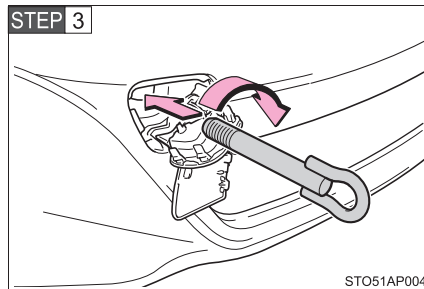

Insert the towing eyelet into the hole and tighten partially by hand.

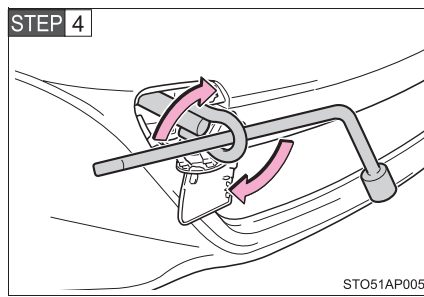

Tighten down the towing eyelet securely using a wheel nut wrench.

Towing with a sling-type truck

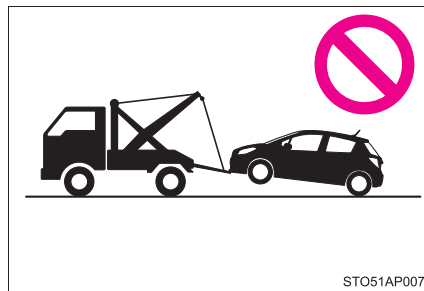

Do not tow with a sling-type truck to prevent body damage.

Towing with a wheel-lift type truck

From the front

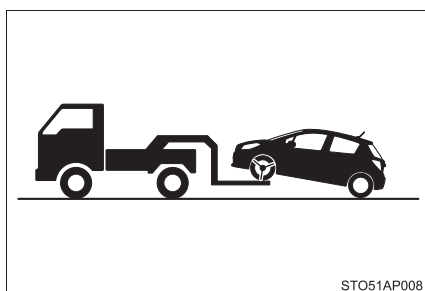

Release the parking brake.

From the rear

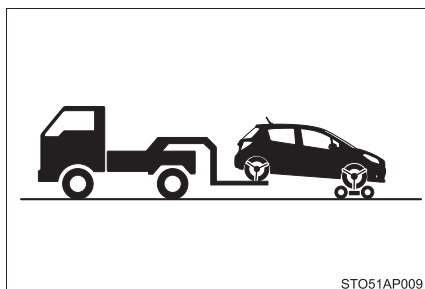

Vehicles with a Multidrive: Use a towing dolly under the front wheels.

Except vehicles with a Multidrive: We recommend using a towing dolly under the front wheels.

Vehicles without a smart entry & start system: When not using a towing dolly, turn the engine switch to the "ON" position (vehicles with a multi-mode manual transmission) or the "ACC" position (vehicles with a manual transmission) and shift the shift lever to N.

Vehicles with a smart entry & start system: When not using a towing dolly, turn the "ENGINE START STOP" switch to IGNITION ON mode (vehicles with a multi-mode manual transmission) or ACCESSORY mode (vehicles with a manual transmission) and shift the shift lever to N.

Using a flatbed truck

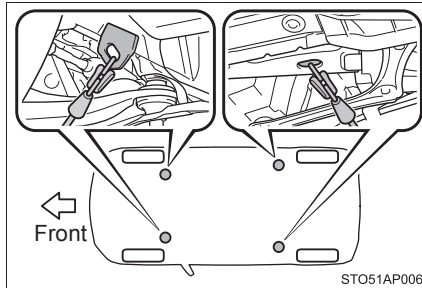

If your Toyota is transported by a flatbed truck, it should be tied down at the locations shown in the illustration.

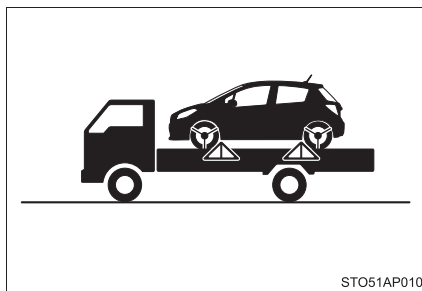

If you use chains or cables to tie down your vehicle, the angles shaded in black must be 45°.

Do not overly tighten the tie downs or the vehicle may be damaged.

■ Before emergency towing

STEP 1 Release the parking brake.

STEP 2 Shift the shift lever to N.

STEP 3 Vehicles without a smart entry & start system: Turn the engine switch to the “ACC” (engine off) or “ON” (engine running) position.

Vehicles with a smart entry & start system: Turn the “ENGINE START STOP” switch to ACCESSORY (engine off) or IGNITION ON (engine running) mode.

■ Emergency towing eyelet location

→P. 459, 471

 CAUTION

■ **Caution while towing**

- Use extreme caution when towing the vehicle.
Avoid sudden starts or erratic driving maneuvers which place excessive stress on the emergency towing eyelet and the cable or chain. Always be cautious of the surroundings and other vehicles while towing.
- Vehicles with a smart entry & start system: Do not turn the “ENGINE START STOP” switch off.
Doing so will lock the steering wheel and prevent operation, possibly causing an accident and resulting in death or serious injury.
- If the engine is not running, the power assist for the brakes and steering will not function, making steering and braking more difficult.

■ **Installing towing eyelet to the vehicle**

Make sure that towing eyelet is installed securely.
If not securely installed, towing eyelet may come loose during towing. This may lead to accidents that cause serious injury or even death.

 NOTICE

■ **To prevent causing serious damage to the transmission when towing using a wheel-lift type truck (vehicles with a Multidrive)**

Never tow this vehicle from the rear with the front wheels on the ground.

■ **To prevent causing serious damage to the Stop & Start system when towing (vehicles with a Stop & Start system)**

Never tow this vehicle with four wheels on the ground. Use a flatbed truck, or lift up front or rear of the vehicle by using a wheel-lift type truck.

■ **To prevent damage to the vehicle when towing using a wheel-lift type truck (vehicles with a Multidrive)**

When raising the vehicle, ensure adequate ground clearance for towing at the opposite end of the raised vehicle. Without adequate clearance, the vehicle could be damaged while being towed.

■ **To prevent damage to the vehicle when towing using a wheel-lift type truck (except vehicles with a Multidrive)**

● Vehicles without a smart entry & start system: Do not tow the vehicle from the rear when the engine switch is in the “LOCK” position or the key is removed. The steering lock mechanism is not strong enough to hold the front wheels straight.

● Vehicles with a smart entry & start system: Do not tow the vehicle from the rear when the “ENGINE START STOP” switch is off. The steering lock mechanism is not strong enough to hold the front wheels straight.

● When raising the vehicle, ensure adequate ground clearance for towing at the opposite end of the raised vehicle. Without adequate clearance, the vehicle could be damaged while being towed.

■ **To prevent body damage when towing with a sling-type truck**

Do not tow with a sling-type truck, either from the front or rear.

5-1. Essential information

If you think something is wrong

If you notice any of the following symptoms, your vehicle probably needs adjustment or repair. Contact any authorized Toyota dealer or repairer, or another duly qualified and equipped professional as soon as possible.

■ Visible symptoms

- Fluid leaks under the vehicle
(Water dripping from the air conditioning after use is normal.)
- Flat-looking tires or uneven tire wear
- High engine coolant temperature warning light flashes or comes on
- Low engine coolant temperature indicator comes on or does not come on continuously

■ Audible symptoms

- Changes in exhaust sound
- Excessive tire squeal when cornering
- Strange noises related to the suspension system
- Pinging or other noises related to the engine

■ Operational symptoms

- Engine missing, stumbling or running roughly
- Appreciable loss of power
- Vehicle pulls heavily to one side when braking
- Vehicle pulls heavily to one side when driving on a level road
- Loss of brake effectiveness, spongy feeling, pedal almost touches the floor

5-1. Essential information

Fuel pump shut off system (gasoline engine only)

To minimize the risk of fuel leakage when the engine stalls or when an airbag inflates upon collision, the fuel pump shut off system stops the supply of fuel to the engine.

Follow the procedure below to restart the engine after the system is activated.

Vehicles without a smart entry & start system

STEP 1 Turn the engine switch to the “ACC” or “LOCK” position.

STEP 2 Restart the engine.

Vehicles with a smart entry & start system

STEP 1 Turn the “ENGINE START STOP” switch to ACCESSORY mode or turn it off.

STEP 2 Restart the engine.

NOTICE

■ Before starting the engine

Inspect the ground under the vehicle.

If you find that fuel has leaked onto the ground, the fuel system has been damaged and is in need of repair. Do not restart the engine.

5-2. Steps to take in an emergency

If a warning light turns on or a warning buzzer sounds...

Calmly perform the following actions if any of the warning lights comes on or flashes. If a light comes on or flashes, but then goes off, this does not necessarily indicate a malfunction in the system. However, if this continues to occur, have the vehicle inspected by any authorized Toyota dealer or repairer, or another duly qualified and equipped professional.

Stop the vehicle immediately. Continuing to drive the vehicle may be dangerous.

The following warning indicates a possible problem in the brake system. Immediately stop the vehicle in a safe place and contact any authorized Toyota dealer or repairer, or another duly qualified and equipped professional.



Warning light	Warning light/Details
	Brake system warning light (warning buzzer)* <ul style="list-style-type: none">• Low brake fluid• Malfunction in the brake system This light also comes on when the parking brake is not released. If the light turns off after the parking brake is fully released the system is operating normally.

*: Parking brake engaged warning buzzer:

The buzzer sounds to indicate that the parking brake is still engaged (with the vehicle having reached a speed of 5 km/h [3 mph]).

Stop the vehicle immediately.

- The following warnings indicate the possibility of damage to the vehicle that may lead to an accident. Immediately stop the vehicle in a safe place and contact any authorized Toyota dealer or repairer, or another duly qualified and equipped professional.

Warning light	Warning light/Details
	Charging system warning light Indicates a malfunction in the vehicle's charging system.
	Low engine oil pressure warning light Indicates that the engine oil pressure is too low.
 (Flashes or comes on)	High engine coolant temperature warning light Indicates that the engine is overheating. (→P. 505) • Flashes: Engine is overheating. Drive carefully. • Comes on: Engine is overheated. Stop the vehicle.

- The following warning indicates the possibility of damage to the vehicle that may lead to an accident. Immediately stop the vehicle in a safe place and take the specified steps to correct the suspected problem.

Warning light	Warning light/Details	Correction procedure
 (Comes on) (if equipped)	Multi-mode manual transmission warning light Indicates a malfunction in the multi-mode manual transmission system.	Have the system checked by any authorized Toyota dealer or repairer, or another duly qualified and equipped professional.
	Multi-mode manual transmission warning light (warning buzzer) Indicates a malfunction in the multi-mode manual transmission system and that the clutch has become hot due to excessive load.	Pull over and shift the shift lever to N. Wait for about 15 minutes for the clutch to cool down. Have the system checked by any authorized Toyota dealer or repairer, or another duly qualified and equipped professional.

5-2. Steps to take in an emergency

- Immediately stop the vehicle in a safe place and take the specified steps to correct the suspected problem.







Warning light	Warning light/Details	Correction procedure
 (Flashes) (if equipped)	Heat clutch warning light (warning buzzer) Indicates that the clutch has become hot, but does not indicate a malfunction in the multi-mode manual transmission system.	Pull over and shift the shift lever to N. Wait for about 15 minutes for the clutch to cool down.

■ To prevent the clutch from overheating



- Do not use the accelerator pedal or starting assist system to hold the vehicle on a hill.
- On an uphill incline, observe the following whenever possible:
 - Maintain a safe distance from the vehicle ahead and avoid unnecessary starting off and stopping.
 - Avoid using E mode on an uphill slope. This will help to avoid unnecessary gear changes.

Have the vehicle inspected immediately.

Failure to investigate the cause of the following warnings may lead to the system operating abnormally and possibly cause an accident. Have the vehicle inspected by any authorized Toyota dealer or repairer, or another duly qualified and equipped professional immediately.





Warning light	Warning light/Details
	Malfunction indicator lamp Indicates a malfunction in: <ul style="list-style-type: none"> • The electronic engine control system; • The electronic throttle control system; • The electronic Multidrive control system (if equipped); • The electronic Multi-mode manual transmission control system (if equipped); • The emission control system; or • The DPF catalytic converter (if equipped).
	SRS warning light Indicates a malfunction in: <ul style="list-style-type: none"> • The SRS airbag system; or • The seat belt pretensioner system.
	ABS warning light Indicates a malfunction in: <ul style="list-style-type: none"> • The ABS; or • The brake assist system.
	Electric power steering warning light (warning buzzer) Indicates a malfunction in the EPS system.
	Slip indicator light (if equipped) Indicates a malfunction in: <ul style="list-style-type: none"> • The VSC system; or • The TRC system.
 (Flashes)	Cruise control indicator light (if equipped) Indicates a malfunction in the cruise control system.

5-2. Steps to take in an emergency

Warning light	Warning light/Details
 (Flashes)	Stop & Start cancel indicator light (if equipped) Indicates a malfunction in the Stop & Start system.
	Fuel filter warning light (diesel engine only) Indicate that the amount of accumulated water in the fuel filter has reached the specified level. (→P. 389)
 (Flashes in yellow for 15 seconds.)	Smart entry & start system indicator light (If equipped) Indicates a malfunction in the smart entry & start system.

Follow the correction procedures.

After taking the specified steps to correct the suspected problem, check that the warning light goes off.

Warning light	Warning light/Details	Correction procedure
	Open door warning light (warning buzzer)*¹ Indicates that a door is not fully closed.	Check that all the doors are closed.
	Low fuel level warning light Gasoline engine: Indicates that remaining fuel is about 5.8 L (1.5 gal., 1.3 Imp. gal.) or less. Diesel engine: Indicates that remaining fuel is about 6.4 L (1.7 gal., 1.4 Imp. gal.) or less.	Refuel the vehicle.
 (On the instrument cluster)	Driver's and front passenger's seat belt reminder light (warning buzzer)*² Warns the driver and front passenger to fasten their seat belts.	Fasten the seat belt.
 (On the center panel)	Rear passengers' seat belt reminder lights (warning buzzer)*² Warns the rear passengers to fasten their seat belts.	Fasten the seat belt.
	Low engine oil level warning light (diesel engine only) Indicates that engine oil level is low.	Check the level of engine oil, and add if necessary.

5-2. Steps to take in an emergency

Warning light	Warning light/Details	Correction procedure
	<p>DPF system warning light (diesel engine with a DPF system warning light)</p> <ul style="list-style-type: none"> • Indicates that the DPF catalytic converter needs to be cleaned due to repeated short trips and/or low-speed driving. • Indicates that the amount of accumulated deposits in the DPF catalytic converter has reached the specified level. 	<p>To clean the DPF catalytic converter, drive the vehicle at a speed of 65 km/h (40 mph) or greater for 20 to 30 minutes as much as possible until the DPF system warning light turns off.*³</p> <p>Do not turn off the engine as much as possible until the DPF system warning light turns off.</p> <p>If it is not possible to drive the vehicle at speeds of 65 km/h (40 mph) or greater, or the DPF system warning light does not turn off even after driving for more than 30 minutes, have the vehicle inspected by any authorized Toyota dealer or repairer, or another duly qualified and equipped professional.</p>

Warning light	Warning light/Details	Correction procedure
<div data-bbox="395 907 491 967" style="border: 1px solid black; padding: 2px; display: inline-block; text-align: center;"> MAINT REQD </div> (Flashes)	<p>Engine oil change reminder light (diesel engine only)</p> <p>Indicates that the engine oil is scheduled to be changed.</p> <ul style="list-style-type: none"> • Vehicles without a DPF system*4: Flashes approximately 35000 km (22000 miles) after the engine oil is changed. (The indicator will not work properly unless the oil maintenance data has been reset). • Vehicles with a DPF system*4: Flashes approximately 14500 km (9000 miles) after the engine oil is changed. (→P. 456) (The indicator will not work properly unless the oil maintenance data has been reset). 	<p>Check the engine oil, and change if necessary. After changing the engine oil, the oil change system should be reset. (→P. 380)</p>

5-2. Steps to take in an emergency

Warning light	Warning light/Details	Correction procedure
 (Comes on)	<p>Engine oil change reminder light (diesel engine only)</p> <p>Indicates that the engine oil should be changed.</p> <ul style="list-style-type: none"> • Vehicles without a DPF system*⁴: Comes on approximately 40000 km (25000 miles) after the engine oil is changed (and the oil maintenance data has been reset). • Vehicles with a DPF system*⁴: Comes on approximately 15000 km (9300 miles) after the engine oil is changed (and the oil maintenance data has been reset). 	<p>Check and change the engine oil and oil filter by any authorized Toyota dealer or repairer, or another duly qualified and equipped professional. After changing the engine oil, the oil change system should be reset. (→P. 380)</p>

*1: Open door warning buzzer:

A buzzer will sound if the vehicle reaches a speed of 5 km/h (3 mph) or more with any door open.

*2: Driver's and passengers seat belt reminders:



The driver's and passengers seat belt buzzer sounds to alert the driver and passengers that their seat belt is not fastened. The buzzer sounds for 30 seconds after the vehicle has reached a speed of at least 20 km/h (12 mph). Then, if the seat belt is still unfastened, the buzzer will sound in a different tone for 90 more seconds.

*3: The DPF system warning light may not turn off when the engine oil change reminder light is on. In this event, have the vehicle inspected by any authorized Toyota dealer or repairer, or another duly qualified and equipped professional.





*4: To determine whether or not your vehicle has a DPF system, contact any authorized Toyota dealer or repairer, or another duly qualified and equipped professional.



Follow the correction procedures. (vehicles with a smart entry & start system)

After taking the specified steps to correct the suspected problem, check that the warning light goes off.

Interior buzzer	Exterior buzzer	Warning light	Warning light/Details	Correction procedure
Continuous	Continuous	 (Flashes in yellow)	Smart entry & start system indicator light (vehicles with a Multidrive) The electronic key was carried outside the vehicle and the driver's door was opened and closed while any shift position other than P was selected without turning off the "ENGINE START STOP" switch.	<ul style="list-style-type: none"> • Change the shift position to P. • Bring the electronic key back into the vehicle.
Once	3 times	 (Flashes in yellow)	Smart entry & start system indicator light Vehicles with a Multidrive: The electronic key was carried outside the vehicle and the driver's door was opened and closed while the shift position P was selected without turning off the "ENGINE START STOP" switch. Except vehicle with a Multidrive: The electronic key was carried outside the vehicle and a door other than the driver's door was opened and closed while the "ENGINE START STOP" switch was in a mode other than off.	Turn the "ENGINE START STOP" switch off or bring the electronic key back into the vehicle.

5-2. Steps to take in an emergency

Interior buzzer	Exterior buzzer	Warning light	Warning light/Details	Correction procedure
Once	3 times	 (Flashes in yellow)	Smart entry & start system indicator light Indicates that a door other than the driver's door has been opened and closed with the "ENGINE START STOP" switch in any mode other than off and the electronic key outside of the detection area.	Confirm the location of the electronic key.
Once	Continuous (10 seconds)	 (Flashes in yellow)	Smart entry & start system indicator light An attempt was made to exit the vehicle with the electronic key and lock the doors without first turning the "ENGINE START STOP" switch off.	Turn the "ENGINE START STOP" switch off and lock the doors again.
Once	—	 (Flashes in yellow for 15 seconds.)	Smart entry & start system indicator light Indicates that the electronic key is not present when attempting to start the engine.	Confirm the location of the electronic key.
9 times	—	 (Flashes in yellow)	Smart entry & start system indicator light An attempt was made to drive when the regular key was not inside the vehicle.	Confirm that the electronic key is inside the vehicle.
Once	—	 (Flashes in yellow for 15 seconds.)	Smart entry & start system indicator light Indicates that the electronic key battery is low.	Replace the battery. (→P. 401)

Interior buzzer	Exterior buzzer	Warning light	Warning light/Details	Correction procedure
Once	—	 (Flashes quickly in green for 15 seconds.)	Smart entry & start system indicator light Indicates that the steering lock has not been released.	Release the steering lock. (→P. 175)
Once	—	 (Flashes in yellow for 30 seconds.)	Smart entry & start system indicator light <ul style="list-style-type: none"> • When the doors were unlocked with the mechanical key and then the “ENGINE START STOP” switch was pressed, the electronic key could not be detected in the vehicle. • The electronic key could not be detected in the vehicle even after the “ENGINE START STOP” switch was pressed two consecutive times. 	Except vehicles with a manual transmission: Touch the electronic key to the “ENGINE START STOP” switch while depressing the brake pedal. Vehicles with a manual transmission: Touch the electronic key to the “ENGINE START STOP” switch while depressing with the clutch pedal.

■ **Passenger detection sensor and passenger seat belt reminder**

- If luggage is placed on a passenger seat, the passenger detection sensor may cause the warning light to flash even if a passenger is not sitting in the seat.
- If a cushion is placed on the seat, the sensor may not detect a passenger, and the warning light may not operate properly.

■ **Electric power steering warning light (warning buzzer)**

The electric power steering warning light may come on and the warning buzzer may sound when the voltage is low or the voltage drops.

■ **If the malfunction indicator lamp comes on while driving**

For some models, the malfunction indicator lamp will come on if the fuel tank becomes completely empty. If the fuel tank is empty, refuel the vehicle immediately. The malfunction indicator lamp will go off after several trips.

If the malfunction indicator lamp does not go off, contact any authorized Toyota dealer or repairer, or another duly qualified and equipped professional, as soon as possible.

■ **If the engine oil change reminder light flashes (diesel engine with a DPF system)**

Repeated short trips and/or low-speed driving may cause the oil to degrade sooner than usual, regardless of the actual distance driven. If this happens, the engine oil change reminder light will flash.

■ **Engine oil change reminder light comes on (diesel engine only)**

Vehicles without a DPF system:

Replace the engine oil and oil filter when the engine oil change reminder light does not come on even if you have driven over 40000 km (25000 miles) after the engine oil was changed.

There is a possibility that the engine oil change reminder light has been illuminated when you have driven less than 40000 km (25000 miles) based on a usage or driving condition.

Vehicles with a DPF system:

Replace the engine oil and oil filter when the engine oil change reminder light does not come on even if you have driven over 15000 km (9300 miles) after the engine oil was changed.

There is a possibility that the engine oil change reminder light has been illuminated when you have driven less than 15000 km (9300 miles) based on a usage or driving condition.

 **CAUTION**

■ **When the electric power steering system warning light comes on**

The steering wheel may become extremely heavy.

If the steering wheel becomes heavier than usual when operating, hold firmly and operate using more force than usual.

■ **When driving to clean the DPF catalytic converter**

When driving, pay sufficient attention to weather, road conditions, terrain and traffic conditions, and be sure to observe traffic laws and/or regulations. Failure to do so may cause an unexpected accident, resulting in death or serious injury.

 NOTICE

■ **If the fuel filter warning light comes on (diesel engine only)**

Never drive the vehicle with the warning light on. Continued driving with water accumulated in the fuel filter will damage the fuel injection pump.

■ **When the DPF system warning light comes on (diesel engine with a DPF system)**

If the DPF system warning light is left on without performing cleaning, after an additional 100 to 300 km (62 to 187 miles), the malfunction indicator lamp may come on. If this happens, have the vehicle inspected by any authorized Toyota dealer or repairer, or another duly qualified and equipped professional immediately.

5-2. Steps to take in an emergency If you have a flat tire (vehicles with a spare tire)

Remove the flat tire and replace it with the spare tire provided.

■ Before jacking up the vehicle

- Stop the vehicle on a hard, flat surface.
- Set the parking brake.
- Vehicles with a Multidrive: Shift the shift lever to P.
- Vehicles with a multi-mode manual transmission: Shift the shift lever to M, E or R.
- Vehicles with a manual transmission: Shift the shift lever to R.
- Stop the engine.
- Turn on the emergency flashers.

■ Location of the spare tire, jack and tools

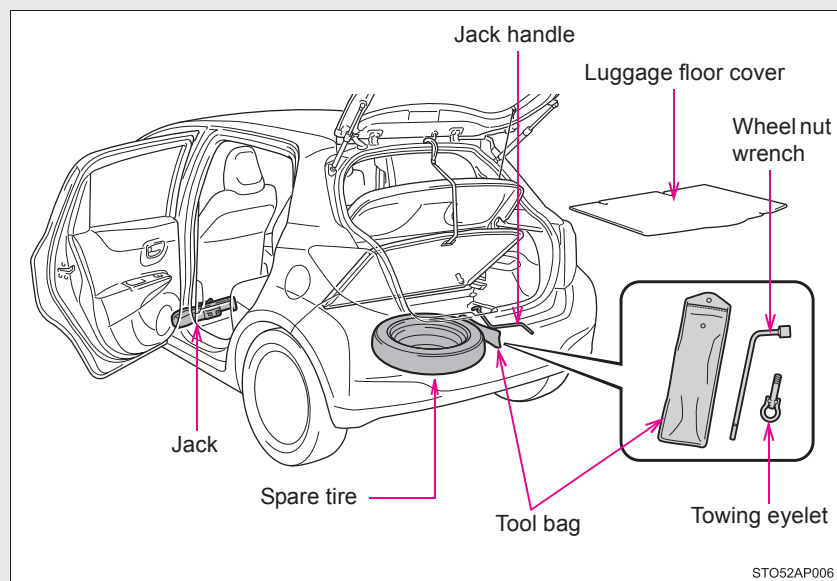

5-2. Steps to take in an emergency

Taking out the jack

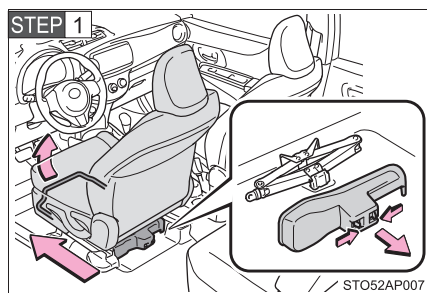

Move the front left seat to the front most position and remove the cover.

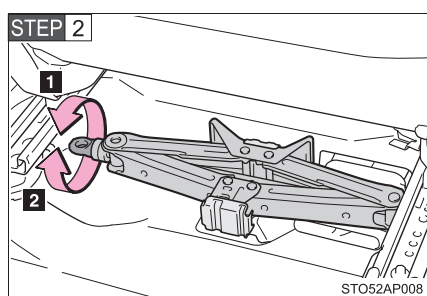

Take out the jack.

- 1** For tightening
- 2** For loosening

Taking out the spare tire

Vehicles with a compact spare tire

STEP 1 Vehicles with a deck board: Lift the deck board and attach the hook. (→P. 350)

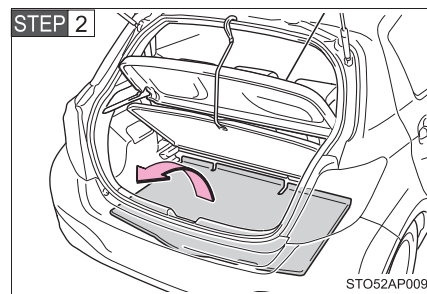

Remove the luggage floor cover.

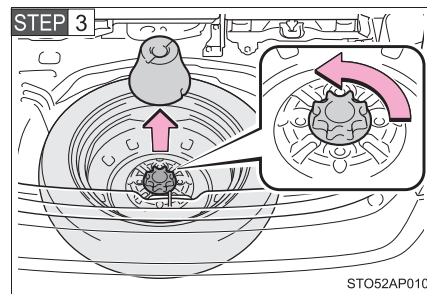

Remove the spare wheel cushion, then loosen the center fastener.

Vehicles with a full-size spare tire

STEP 1 Lift the deck board and attach the hook. (→P. 350)

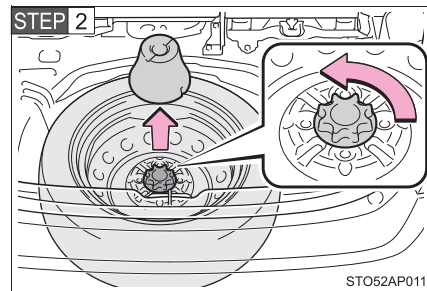

Remove the spare wheel cushion, then loosen the center fastener.

Replacing a flat tire

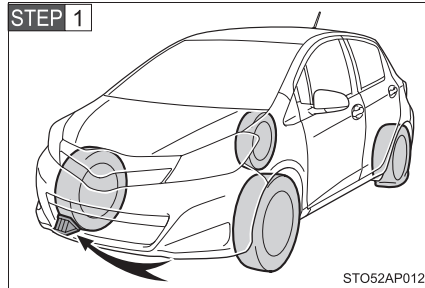

Chock the tires.

Flat tire		Wheel chock positions
Front	Left-hand side	Behind the rear right-hand side tire
	Right-hand side	Behind the rear left-hand side tire
Rear	Left-hand side	In front of the front right-hand side tire
	Right-hand side	In front of the front left-hand side tire

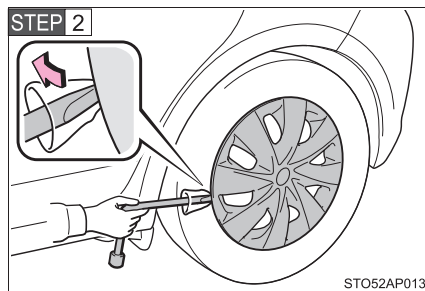

Vehicles with a steel wheel:
Remove the wheel ornament using the wrench.

To protect the wheel ornament, place a rag between the wrench and the wheel ornament, as shown in the illustration.

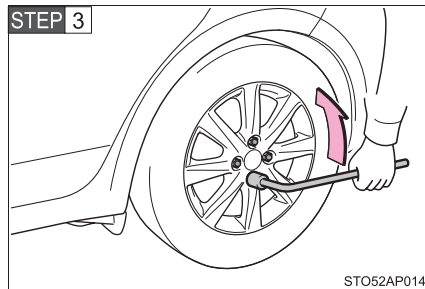

Slightly loosen the wheel nuts (one turn).

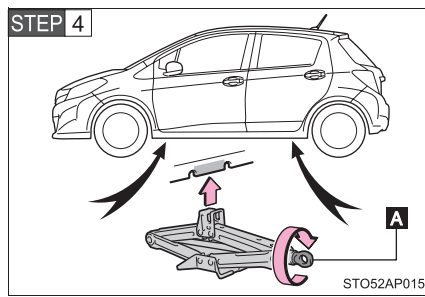

Turn the tire jack portion "A" by hand until the notch of the jack is in contact with the jack point.

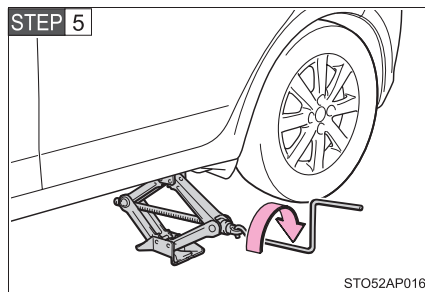

Raise the vehicle until the tire is slightly raised off the ground.

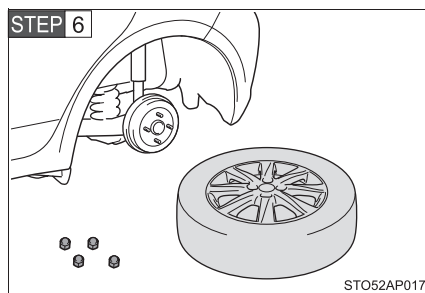

Remove all the wheel nuts and the tire.

When resting the tire on the ground, place the tire so that the wheel design faces up to avoid scratching the wheel surface.

5-2. Steps to take in an emergency

Installing the tire

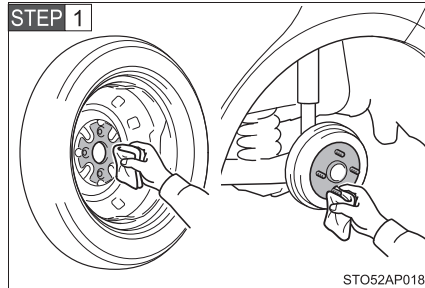

Remove any dirt or foreign matter from the wheel contact surface.

If foreign matter is on the wheel contact surface, the wheel nuts may loosen while the vehicle is in motion, causing the tire to come off.

STEP 2 Install the tire and loosely tighten each wheel nut by hand by approximately the same amount.

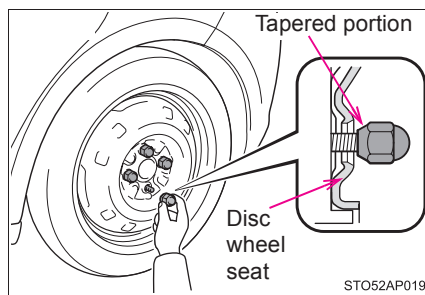

When replacing a steel wheel with a steel wheel (including a compact spare tire), tighten the wheel nuts until the tapered portion comes into loose contact with the disc wheel seat.

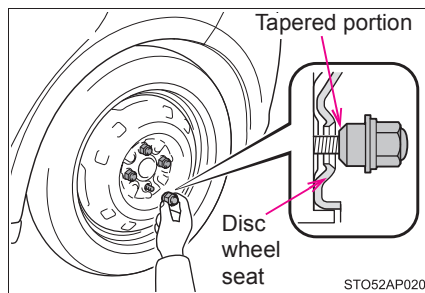

When replacing an aluminum wheel with a compact spare tire, tighten the wheel nuts until the tapered portion comes into loose contact with the disc wheel seat.

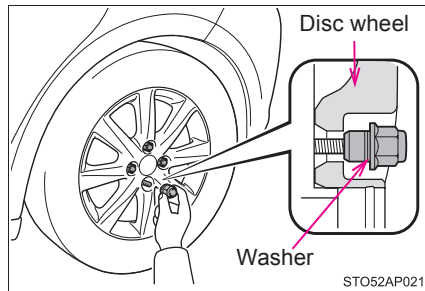

When replacing an aluminum wheel with an aluminum wheel, turn the wheel nuts until the washers come into contact with the disc wheel.

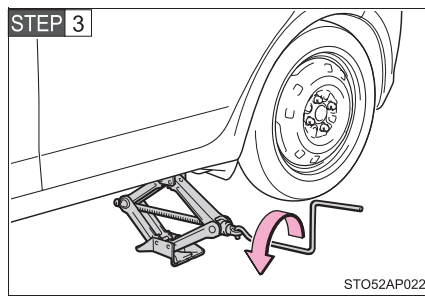

Lower the vehicle.

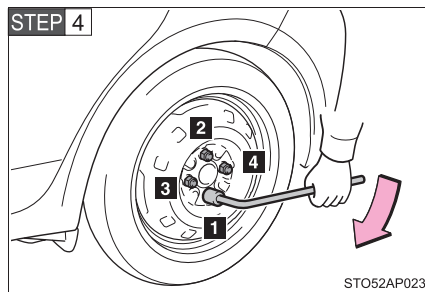

Firmly tighten each wheel nut two or three times in the order shown in the illustration.

Tightening torque:
103 N·m (10.5 kgf·m, 76 ft·lbf)

Do not use other tools or any additional leverage other than your hands, such as a hammer, pipe or your foot.

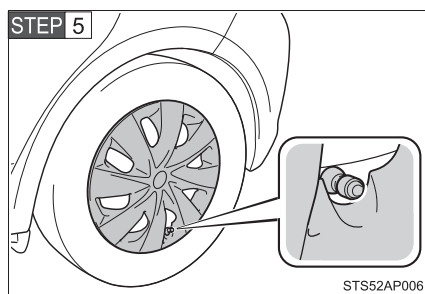

Vehicles with steel wheels (except compact spare tire):
Reinstall the wheel ornament.

Align the cutout of the wheel ornament with the valve stem as shown.

5-2. Steps to take in an emergency

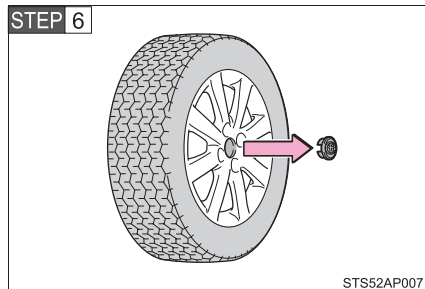

Vehicles with aluminum wheels:
Remove the center wheel ornament by pushing from the reverse side.

Be careful not to lose the wheel ornament.

STEP 7 Stow the flat tire, tire jack and all tools.

■ The compact spare tire

- The compact spare tire is identified by the label “TEMPORARY USE ONLY” on the tire sidewall.
Use the compact spare tire temporarily, and only in an emergency.
- Make sure to check the tire inflation pressure of the compact spare tire.
(→P. 533)

■ If you have a flat front tire on a road covered with snow or ice

Install the compact spare tire on one of the rear wheels of the vehicle. Perform the following steps and fit tire chains to the front tires:

STEP 1 Replace a rear tire with the compact spare tire.

STEP 2 Replace the flat front tire with the tire removed from the rear of the vehicle.

STEP 3 Fit tire chains to the front tires.

■ Certification for the jack



Manufacturer's Declaration of Conformity

Manufacturer:

Kawasaki Industrial Co., Ltd.
4618 Mukaijima Shimada, Shizuoka, Japan

The EU Directives covered by this Declaration

2006/42/EC Machinery Directive

The product covered by this declaration

JACK SUB-ASSY,PANTOGRAPH

model

0.8ton , 1.1ton , 1.35ton , 1.5ton

The basis on which conformity is being declared

The product identified above complies with the requirements of
the Machinery Directive
Directive above by meeting following standards

JIS D 8103

The technical documentation required to demonstrate that the product
meets the requirement the Machinery Directive has been compiled by
the signatory below and is available for inspection by the relevant
enforcement authorities.

A sample of the product has been tested by the manufacturer

Technical File No: KSF-201-00-01

The CE mark was first applied in:2010

Done at Shizuoka, Japan

Signature:

Koji Kawasaki
PRESIDENT ,Kawasaki Industrial Co., Ltd.

Date of Issue: 25 December.2009

5

When trouble arises

 CAUTION

■ **When using the compact spare tire**

- Remember that the compact spare tire provided is specifically designed for use with your vehicle. Do not use your compact spare tire on another vehicle.
- Do not use more than one compact spare tire simultaneously.
- Replace the compact spare tire with a standard tire as soon as possible.
- Avoid sudden acceleration, deceleration and braking, as well as sharp cornering.

■ **When storing the compact spare tire**

Be careful not to catch fingers or other body parts between the compact spare tire and the body of the vehicle.

■ **When the compact spare tire is attached**

The vehicle speed may not be correctly detected, and the following systems may not operate correctly:

- ABS
- Brake assist
- VSC (if equipped)
- TRC (if equipped)
- Cruise control (if equipped)
- Navigation system (if equipped)

■ **Speed limit when using the compact spare tire**

Do not drive at speeds in excess of 80 km/h (50 mph) when a compact spare tire is installed on the vehicle.

The compact spare tire is not designed for driving at high speeds. Failure to observe this precaution may lead to an accident causing death or serious injury.

 CAUTION**■ Using the tire jack**

Improper use of the tire jack may cause the vehicle to suddenly fall off the jack, leading to death or serious injury.

- Do not use the tire jack for any purpose other than replacing tires or installing and removing tire chains.
- Only use the tire jack that comes with this vehicle for replacing a flat tire. Do not use it on other vehicles, and do not use other tire jacks for replacing tires on this vehicle.
- Always check that the tire jack is securely set to the jack point.
- Do not put any part of your body under the vehicle while it is supported by the jack.
- Do not start or run the engine while your vehicle is supported by the jack.
- Do not raise the vehicle while someone is inside.
- When raising the vehicle, do not put an object on or under the jack.
- Do not raise the vehicle to a height greater than that required to replace the tire.
- Use a jack stand if it is necessary to get under the vehicle.

Take particular care when lowering the vehicle to ensure that no one working on or near the vehicle may be injured.

 CAUTION

■ **Replacing a flat tire**

- Do not touch the disc wheels or the area around the brakes immediately after the vehicle has been driven.
After the vehicle has been driven the disc wheels and the area around the brakes will be extremely hot. Touching these areas with hands, feet or other body parts while changing a tire, etc. may result in burns.
- Failure to follow these precautions could cause the wheel nuts to loosen and the tire to fall off, resulting in death or serious injury.
 - Have the wheel nuts tightened with a torque wrench to 103 N·m (10.5 kgf·m, 76 ft·lbf) as soon as possible after changing wheels.
 - When installing a tire, only use wheel nuts that have been specifically designed for that wheel.
 - If there are any cracks or deformations in the bolt screws, nut threads or bolt holes of the wheel, have the vehicle inspected by any authorized Toyota dealer or repairer, or another duly qualified and equipped professional.
 - When installing the wheel nuts, be sure to install them with the tapered ends facing inward. (→P. 397)

 NOTICE

■ **Do not drive the vehicle with a flat tire**

Do not continue driving with a flat tire.
Driving even a short distance with a flat tire can damage the tire and the wheel beyond repair.

■ **Be careful when driving over bumps with the compact spare tire installed on the vehicle**

The vehicle becomes lower when driving with the compact spare tire compared to when driving with standard tires. Be careful when driving over uneven road surfaces.

■ **Driving with tire chains and the compact spare tire**

Do not fit tire chains to the compact spare tire.
Tire chains may damage the vehicle body and adversely affect driving performance.

5-2. Steps to take in an emergency

If you have a flat tire (vehicles with an emergency tire puncture repair kit)

A puncture caused by a nail or screw passing through the tire tread can be repaired temporarily using the emergency tire puncture repair kit. (The kit contains a bottle of sealant. The sealant can be used only once to temporarily repair one tire without removing the nail or screw from the tire.) Depending on the damage, this kit cannot be used to repair the tire. (→P. 474)

After temporarily repairing the tire with the kit, have the tire repaired or replaced by any authorized Toyota dealer or repairer, or another duly qualified and equipped professional. Repairs conducted using the emergency tire puncture repair kit are only a temporary measure. Have the tire repaired and replaced as soon as possible.

■ Before repairing the tire

- Stop the vehicle in a safe place on a hard, flat surface.
- Set the parking brake.
- Vehicles with a Multidrive: Shift the shift lever to P.
- Vehicles with a multi-mode manual transmission and manual transmission: Shift the shift lever to N.
- Stop the engine.
- Turn on the emergency flashers.

5-2. Steps to take in an emergency

■ Location of the emergency tire puncture repair kit

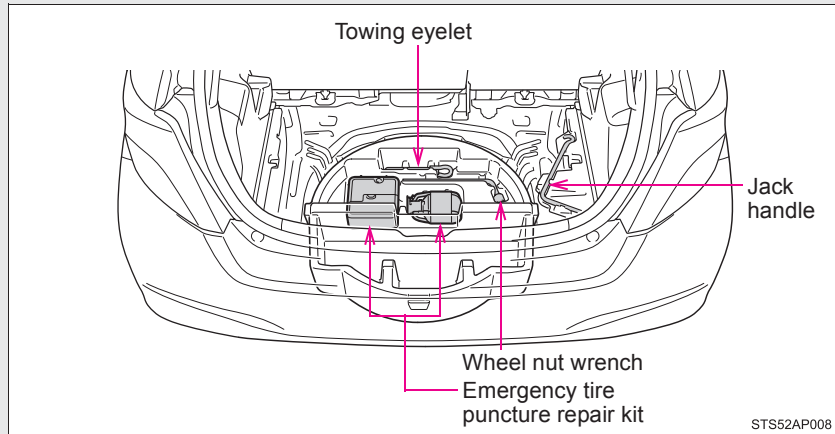

■ Emergency tire puncture repair kit components

Bottle

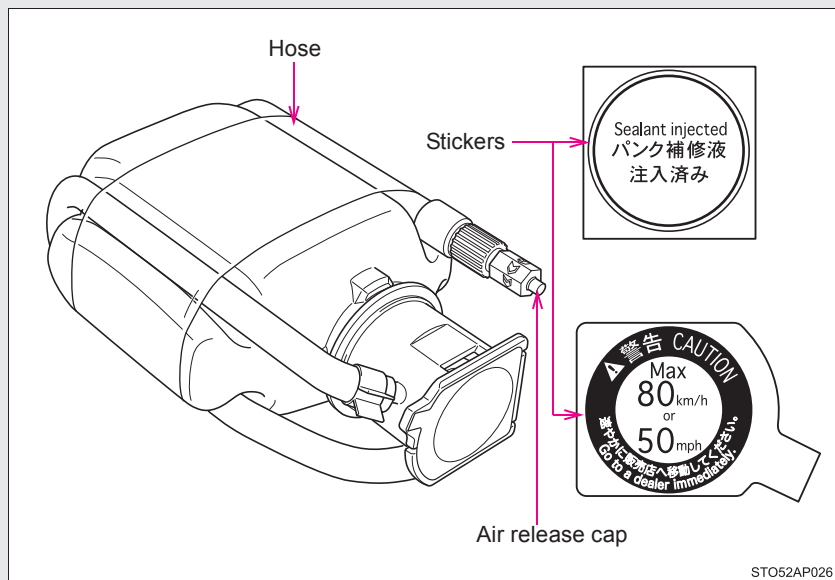

Compressor

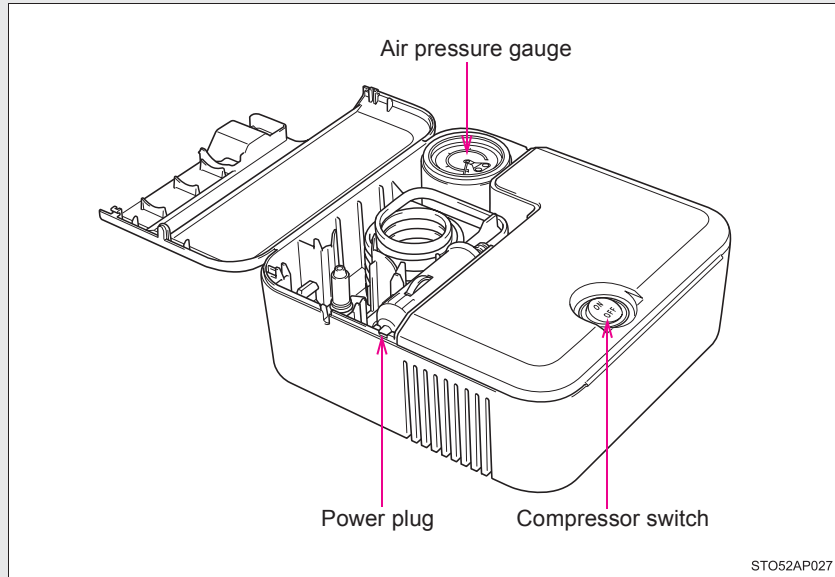

Before performing emergency repair

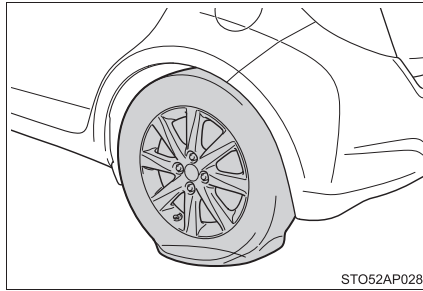

Check the degree of the tire damage.

- Do not remove the nail or screw from the tire. Removing the object may widen the opening and prevent emergency repair with the repair kit.
- To avoid sealant leakage, move the vehicle until the area of the puncture, if known, is positioned at the top of the tire.

■ **In the following cases, the tire cannot be repaired with the emergency tire puncture repair kit. Contact any authorized Toyota dealer or repairer, or another duly qualified and equipped professional.**

- When the tire is damaged due to driving without sufficient air pressure
- When there are any cracks or damage at any location on the tire, such as on the side wall, except the tread
- When the tire is visibly separated from the wheel
- When the cut or damage to the tread is 4 mm (0.16 in.) long or more
- When the wheel is damaged
- When two or more tires have been punctured
- When more than 2 sharp objects such as nails or screws have passed through the tread on a single tire
- When the sealant has expired

Taking out the emergency tire puncture repair kit

Vehicles without a deck board

STEP 1

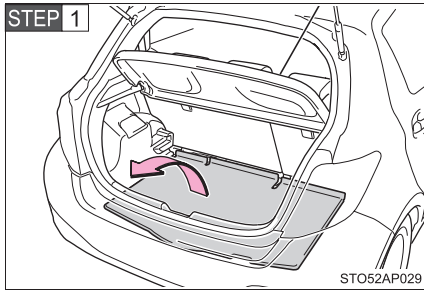

Remove the luggage floor cover.

STEP 2

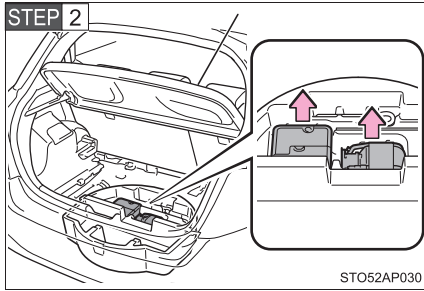

Take out the emergency tire puncture repair kit.

Vehicles with a deck board

STEP 1

Lift the deck board and attach the hook. (→P. 350)

STEP 2

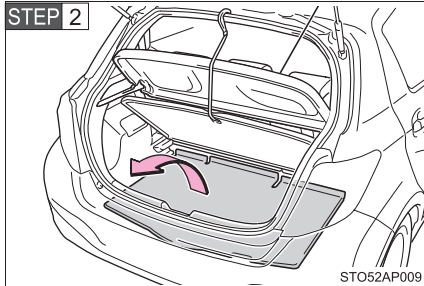

Remove the luggage floor cover.

5-2. Steps to take in an emergency

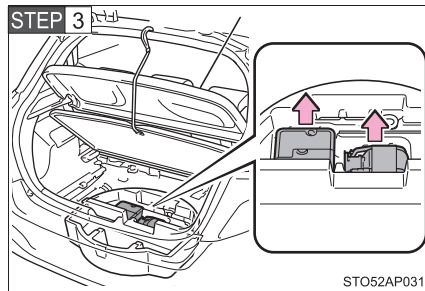

Take out the emergency tire puncture repair kit.

Emergency repair method

STEP 1 Take out the repair kit from the tool box.

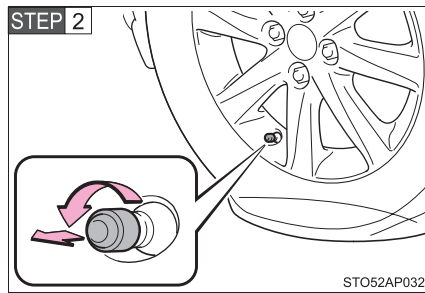

Remove the valve cap from the valve of the punctured tire.

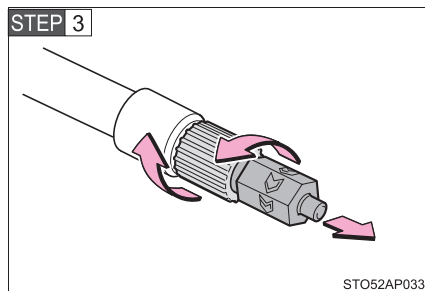

Remove the protective film from the bottle and extend the hose. Remove the air release cap from the hose.

Attach the sticker enclosed with the bottle on the specified locations. (See **STEP 9**.)

You will use the air release cap again. Therefore keep it in a safe place.

5-2. Steps to take in an emergency

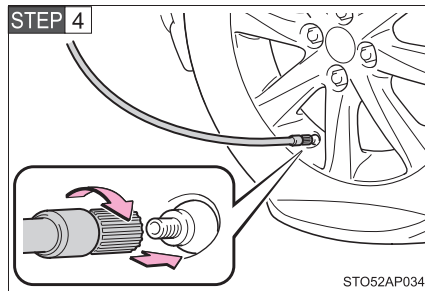

Connect the hose to the valve.

Screw the end of the hose clockwise as far as possible.

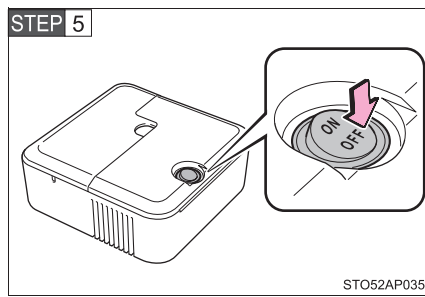

Make sure that the compressor switch is off.

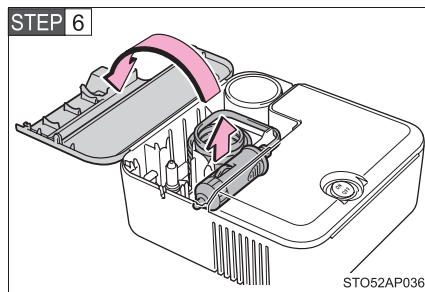

Remove the power plug from the compressor.

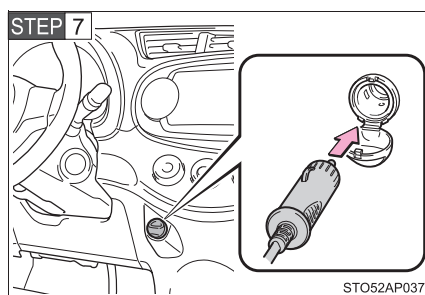

Connect the power plug to the power outlet socket or cigarette lighter socket.

5

When trouble arises

5-2. Steps to take in an emergency

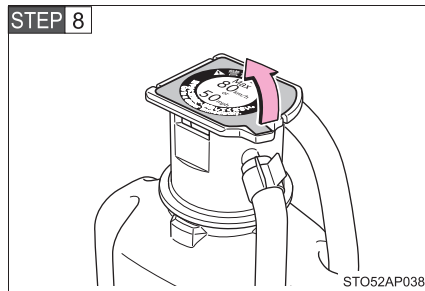

Remove the sticker.

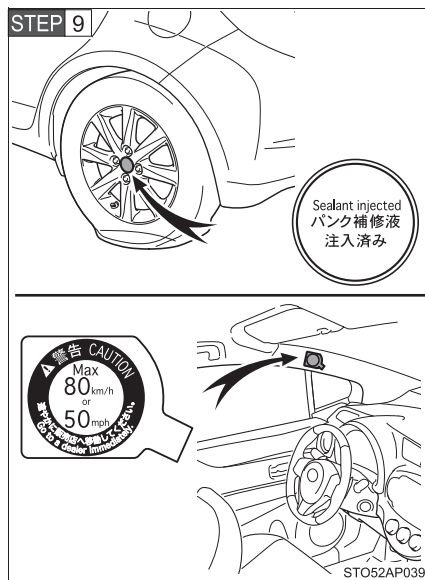

Attach the 2 stickers as shown.

Remove any dirt and moisture from the wheel before attaching the label. If it is impossible to attach the label, make sure to tell any authorized Toyota dealer or repairer, or other duly qualified and equipped professional when you have them repair and replace the tire that sealant is injected.

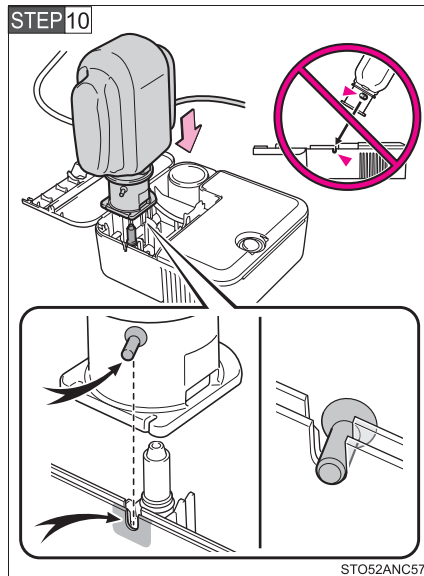

STEP 10 Connect the bottle to the compressor.

As shown in the illustration, insert the bottle vertically into the compressor to connect making sure that the claw on the bottle's neck is hooked onto the cutout of the compressor case.

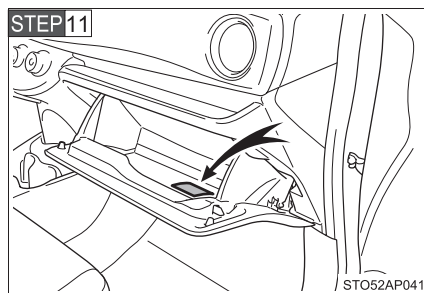

STEP 11 Check the specified tire inflation pressure.

Tire inflation pressure is specified on the label in the glove box. (→P. 533)

STEP 12 Start the vehicle's engine.

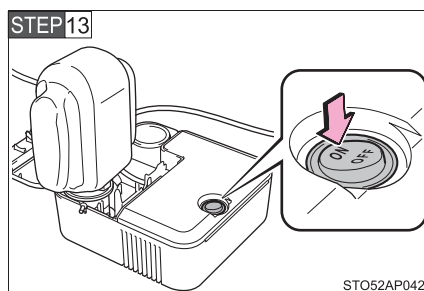

STEP 13 To inject the sealant and inflate the tire, turn the compressor switch on.

5-2. Steps to take in an emergency

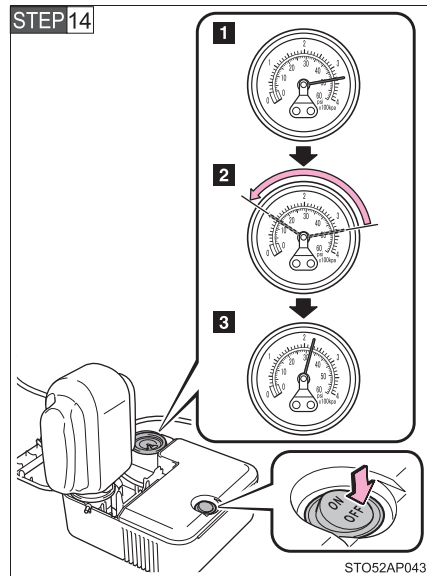

Inflate the tire until the specified air pressure is reached.

- 1** The sealant will be injected and the pressure will surge and then gradually decrease.
- 2** The air pressure gauge will display the actual tire inflation pressure about 1 minute (5 minutes at low temperature) after the switch is turned on.
- 3** Inflate the tire until the specified air pressure.

- Turn the compressor switch off and then check the tire inflation pressure. Being careful not to over inflate, check and repeat the inflation procedure until the specified tire inflation pressure is reached.
- If the tire inflation pressure is still lower than the specified point after inflation for 35 minutes with the switch on, the tire is too damaged to be repaired. Turn the compressor switch off and contact any authorized Toyota dealer or repairer, or another duly qualified and equipped professional.
- If the tire inflation pressure exceeds the specified air pressure, let out some air to adjust the tire inflation pressure.
(→P. 483, 533)

STEP 15 With the compressor switch off, disconnect the hose from the valve on the tire and then pull out the power plug from the power outlet socket.

Some sealant may leak when the hose is removed.

STEP 16 Install the valve cap onto the valve of the emergency repaired tire.

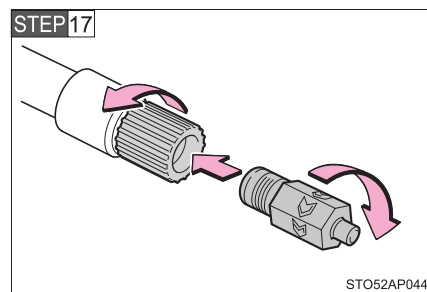

Attach the air release cap to the end of the hose.

If the air release cap is not attached, the sealant may leak and the vehicle may get dirty.

STEP 18 Temporarily store the bottle in the luggage compartment while it is connected to the compressor.

STEP 19 To spread the liquid sealant evenly within the tire, immediately drive safely for about 5 km (3 miles) below 80 km/h (50 mph).

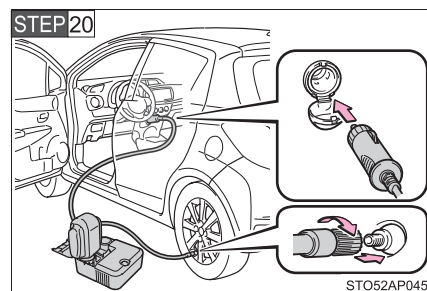

After driving for about 5 km (3 miles), stop your vehicle in a safe place on a hard, flat surface and remove the air release cap from the hose before reconnecting the repair kit.

5-2. Steps to take in an emergency

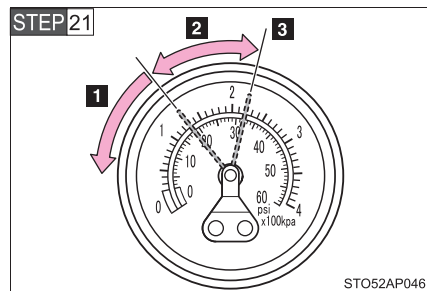

Turn the compressor switch on and wait for an approximately 5 seconds, and then turn it off. Check the tire inflation pressure.

- 1 If the tire inflation pressure is under 130 kPa (1.3 kgf/cm² or bar, 19 psi): The puncture cannot be repaired. Contact any authorized Toyota dealer or repairer, or another duly qualified and equipped professional.
- 2 If the tire inflation pressure is 130 kPa (1.3 kgf/cm² or bar, 19 psi) or higher, but less than the specified air pressure: Proceed to **STEP22**.
- 3 If the tire inflation pressure is the specified air pressure (→P. 533): Proceed to **STEP23**.

STEP22 Turn the compressor switch on to inflate the tire until the specified air pressure is reached. Drive for about 5 km (3 miles) and then perform **STEP20**.

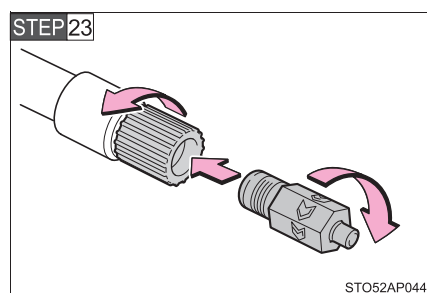

Attach the air release cap to the end of the hose.

If the air release cap is not attached, the sealant may leak and the vehicle may get dirty.

STEP24 Store the bottle in the luggage compartment while it is connected to the compressor.

STEP 25 Taking precautions to avoid sudden braking, sudden acceleration and sharp turns, drive carefully at under 80 km/h (50 mph) to the nearest authorized Toyota dealer or repairer, or another duly qualified and equipped professional for tire repair or replacement.

■ **If the tire is inflated to more than the specified air pressure**

STEP 1 Disconnect the hose from the valve.

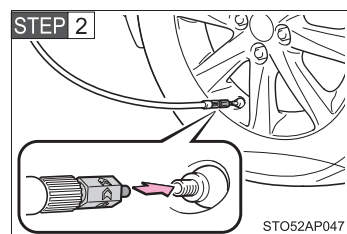

Install the air release cap to the end of the hose and push the protrusion on the air release cap into the tire valve to let some air out.

STEP 3 Disconnect the hose from the valve, remove the air release cap from the hose and then reconnect the hose.

STEP 4 Turn the compressor switch on and wait for several seconds, and then turn it off. Check that the air pressure indicator shows the specified air pressure.

If the air pressure is under the designated pressure, turn the compressor switch on again and repeat the inflation procedure until the specified air pressure is reached.

■ **The valve of a tire that has been repaired**

After a tire is repaired with the emergency tire puncture repair kit, the valve should be replaced.

■ **Note for checking the emergency tire puncture repair kit**

Check the sealant expiry date occasionally.

The expiry date is shown on the bottle. Do not use sealant whose expiry date has already passed. Otherwise, repairs conducted using the emergency tire puncture repair kit may not be performed properly.

5-2. Steps to take in an emergency

■ Emergency tire puncture repair kit

- The sealant stored in the emergency tire puncture repair kit can be used only once to temporarily repair a single tire. If the sealant has been used and needs to be replaced, purchase a new bottle at any authorized Toyota dealer or repairer, or another duly qualified and equipped professional. The compressor is reusable.
- The sealant can be used when the outside temperature is from -30°C (-22°F) to 60°C (140°F).
- The repair kit is exclusively designed for size and type of tires originally installed on your vehicle. Do not use it for tires that a different size than the original ones, or for any other purposes.
- The sealant has a limited lifespan. The expiry date is marked on the bottle. The bottle of sealant should be replaced with a new bottle before the expiry date. Contact any authorized Toyota dealer or repairer, or another duly qualified and equipped professional for replacement.
- If the sealant gets on your clothes, it may stain.
- If the sealant adheres to a wheel or the surface of the vehicle body, the stain may not be removable if it is not cleaned at once. Immediately wipe away the sealant with a wet cloth.
- During operation of the repair kit, a loud operation noise is produced. This does not indicate a malfunction.
- Do not use to check or to adjust the tire pressure.

⚠ CAUTION**■ Do not drive the vehicle with a flat tire**

Do not continue driving with a flat tire.

Driving even a short distance with a flat tire can damage the tire and the wheel beyond repair.

Driving with a flat tire may cause a circumferential groove on the side wall. In such a case, the tire may explode when using a repair kit.

■ Caution while driving

- Store the repair kit in the luggage room.
Injuries may result in the event of an accident or sudden braking.
- The repair kit is exclusively only for your vehicle.
Do not use repair kit on other vehicles, which could lead to an accident causing death or serious injury.
- Do not use repair kit for tires that are different size than the original ones, or for any other purpose. If the tires have not been completely repaired, it could lead to an accident causing death or serious injury.

■ Precautions for use of the sealant

- Ingesting the sealant is hazardous to your health. If you ingest sealant, consume as much water as possible, and then immediately consult a doctor.
- If sealant gets in eyes or adheres to skin, immediately wash it off with water. If discomfort persists, consult a doctor.

■ When fixing the flat tire

- Stop your vehicle in a safe and flat area.
- Do not touch the wheels or the area around the brakes immediately after the vehicle has been driven.
After the vehicle has been driven, the wheels and the area around the brakes may be extremely hot. Touching these areas with hands, feet or other body parts may result in burns.
- Connect the valve and hose securely with the tire installed on the vehicle.
If the hose is not properly connected to the valve, air leakage may occur as sealant may be sprayed out.
- If the hose comes off the valve while inflating the tire, there is a risk that the hose will move abruptly due to air pressure.

 CAUTION

- After inflation of the tire has completed, the sealant may splatter when the hose is disconnected or some air is let out of the tire.
- Follow the operation procedure to repair the tire. If the procedures not followed, the sealant may spray out.
- Keep back from the tire while it is being repaired, as there is a chance of it bursting while the repair operation is being performed. If you notice any cracks or deformation of the tire, turn off the compressor switch and stop the repair operation immediately.
- The repair kit may overheat if operated for a long period of time. Do not operate the repair kit continuously for more than 40 minutes.
- Parts of the repair kit become hot during operation. Be careful when handling the repair kit during and after operation. Do not touch the metal part around the connecting area between the bottle and compressor. It will be extremely hot.
- Do not attach the vehicle speed warning sticker to an area other than the one indicated. If the sticker is attached to an area where an SRS airbag is located, such as the pad of the steering wheel, it may prevent the SRS airbag from operating properly.

■ **Driving to spread the liquid sealant evenly**

Observe the following precautions to reduce the risk of accidents. Failing to do so may result in a loss of vehicle control and cause death or serious injury.

- Drive the vehicle carefully at a low speed. Be especially careful when turning and cornering.
- If the vehicle does not drive straight or you feel a pull through the steering wheel, stop the vehicle and check the following.
 - Tire condition. The tire may have separated from the wheel.
 - Tire inflation pressure. If the tire inflation pressure is 130 kPa (1.3 kgf/cm² or bar, 19 psi) or less, the tire may be severely damaged.

 NOTICE**■ When performing an emergency repair**

- A tire should only be repaired with the emergency tire puncture repair kit if the damage is caused by a sharp object such as nail or screw passing through the tire tread.
Do not remove the sharp object from the tire. Removing the object may widen the opening and disenable emergency repair with the repair kit.
- The repair kit is not waterproof. Make sure that the repair kit is not exposed to water, such as when it is being used in the rain.
- Do not put the repair kit directly onto dusty ground such as sand at the side of the road. If the repair kit vacuums up dust etc., a malfunction may occur.

■ Precautions for the emergency tire puncture repair kit

- The repair kit power source should be 12 V DC suitable for vehicle use. Do not connect the repair kit to any other source.
- If gasoline splatters on the repair kit, the repair kit may deteriorate. Take care not to allow gasoline to contact it.
- Place the repair kit in a storage to prevent it from being exposed to dirt or water.
- Store the repair kit in the luggage room out of reach of children.
- Do not disassemble or modify the repair kit. Do not subject parts such as the air pressure indicator to impacts. This may cause a malfunction.

5-2. Steps to take in an emergency If the engine will not start

If the engine will not start even though correct starting procedures are being followed (→P. 165, 169), consider each of the following points:

■ **The engine will not start even though the starter motor operates normally.**

One of the following may be the cause of the problem:

- There may not be sufficient fuel in the vehicle's tank.
Gasoline engine: Refuel the vehicle.
Diesel engine: (→P. 509)
- The engine may be flooded. (gasoline engine)
Try to restart the engine again following correct starting procedures. (→P. 165, 169)
- There may be a malfunction in the engine immobilizer system.
(→P. 104)

■ **The starter motor turns over slowly, the interior lights and headlights are dim, or the horn does not sound or sounds at a low volume.**

One of the following may be the cause of the problem:

- The battery may be discharged. (→P. 498)
- The battery terminal connections may be loose or corroded.

■ **The starter motor does not turn over. (vehicles with a smart entry & start system)**

The engine starting system may be malfunctioning due to an electrical problem such as an open circuit or a blown fuse. However, an interim measure is available to start the engine.
(→P. 489)

■ **The starter motor does not turn over, the interior lights and headlights do not turn on, or the horn does not sound.**

One of the following may be the cause of the problem:

- One or both of the battery terminals may be disconnected.
- The battery may be discharged. (→P. 498)
- There may be a malfunction in the steering lock system (vehicles with a smart entry & start system).

Contact any authorized Toyota dealer or repairer, or another duly qualified and equipped professional if the problem cannot be repaired, or if repair procedures are unknown.

Emergency start function (vehicles with a smart entry & start system)

When the engine does not start, the following steps can be used as an interim measure to start the engine if the “ENGINE START STOP” switch is functioning normally:

Vehicles with a Multidrive

STEP 1 Set the parking brake.

STEP 2 Shift the shift lever to P.

STEP 3 Turn the “ENGINE START STOP” switch to ACCESSORY mode.

STEP 4 Push and hold the “ENGINE START STOP” switch for about 15 seconds while depressing the brake pedal firmly.

Even if the engine can be started using the above steps, the system may be malfunctioning. Have the vehicle inspected by any authorized Toyota dealer or repairer, or another duly qualified and equipped professional.

Vehicles with a multi-mode manual transmission

STEP 1 Set the parking brake.

STEP 2 Put the shift lever in N.

STEP 3 Turn the “ENGINE START STOP” switch to ACCESSORY mode.

STEP 4 Push and hold the “ENGINE START STOP” switch for about 15 seconds while depressing the brake pedal firmly.

Even if the engine can be started using the above steps, the system may be malfunctioning. Have the vehicle inspected by any authorized Toyota dealer or repairer, or another duty qualified and equipped professional.

Vehicles with a manual transmission

STEP 1 Set the parking brake.

STEP 2 Put the shift lever in N.

STEP 3 Turn the “ENGINE START STOP” switch to ACCESSORY mode.

STEP 4 Push and hold the “ENGINE START STOP” switch for about 15 seconds while depressing the brake pedal and clutch pedal firmly.

Even if the engine can be started using the above steps, the system may be malfunctioning. Have the vehicle inspected by any authorized Toyota dealer or repairer, or another duty qualified and equipped professional.

5-2. Steps to take in an emergency

If the shift lever cannot be shifted from P (vehicles with a Multidrive)

If the shift lever cannot be shifted with your foot on the brake pedal, there may be a problem with the shift lock system (a system to prevent accidental operation of the shift lever). Have the vehicle inspected by any authorized Toyota dealer or repairer, or another duly qualified and equipped professional immediately.

The following steps may be used as an emergency measure to ensure that the shift lever can be shifted:

STEP 1 Set the parking brake.

STEP 2 Vehicles without a smart entry & start system: Turn the engine switch to the “ACC” position.

Vehicles with a smart entry & start system: Turn the “ENGINE START STOP” switch to ACCESSORY mode.

STEP 3 Depress the brake pedal.

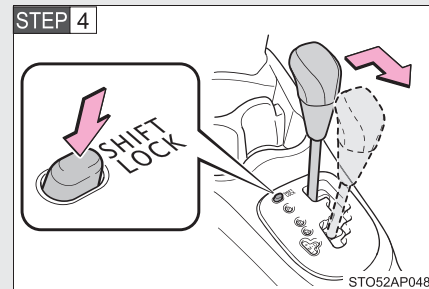

Press the shift lock override button.

The shift lever can be shifted while the button is pressed.

5-2. Steps to take in an emergency

If the shift lever cannot be shifted (vehicles with a multi-mode manual transmission)

If the shift lever cannot be shifted with your foot on the brake pedal, there may be a problem with the shift lock system (a system to prevent accidental operation of the shift lever). Have the vehicle inspected by any authorized Toyota dealer or repairer, or another duly qualified and equipped professional immediately.

The following steps may be used as an emergency measure to ensure that the shift lever can be shifted:

STEP 1 Set the parking brake.

STEP 2 Vehicles without a smart entry & start system: Turn the engine switch to the "ON" position.

Vehicles with a smart entry & start system: Turn the "ENGINE START STOP" switch to IGNITION ON mode.

STEP 3 Depress the brake pedal.

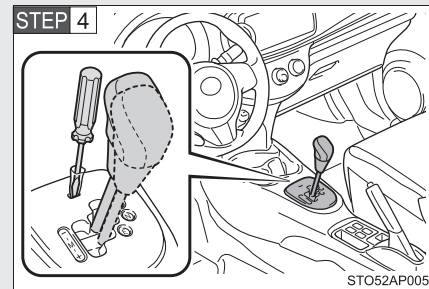

Press the shift lock override button with a flathead screwdriver or equivalent.

The shift lever can be shifted while the button is pressed.

5-2. Steps to take in an emergency If you lose your keys

New genuine Toyota keys can be made by any authorized Toyota dealer or repairer, and another duly qualified and equipped professional using the other key and the key number stamped on your key number plate.

5-2. Steps to take in an emergency

If the electronic key does not operate properly (vehicles with a smart entry & start system)

If communication between the electronic key and vehicle is interrupted (→P. 52) or the electronic key cannot be used because the battery is depleted, the smart entry & start system and wireless remote control cannot be used. In such cases, the doors can be opened and the engine can be started by following the procedure below.

Unlocking and locking the doors

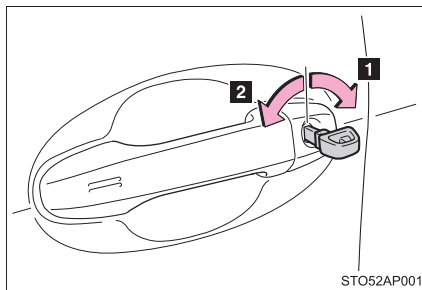

Use the mechanical key (→P. 41) in order to perform the following operations:

- 1 Unlocks all the doors
- 2 Locks all the doors

Starting the engine

Vehicles with a Multidrive

STEP 1 Ensure that the shift lever is in P and firmly depress the brake pedal.

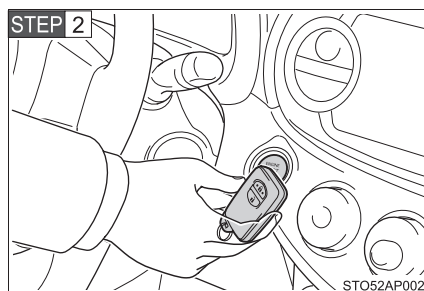

Touch the Toyota emblem side of the electronic key to the “ENGINE START STOP” switch.

The “ENGINE START STOP” switch will turn to IGNITION ON mode.

When the smart entry & start system is deactivated in customization setting, the “ENGINE START STOP” switch will turn to ACCESSORY mode. Modes can be changed by pressing the “ENGINE START STOP” switch with the brake pedal released. (The mode changes each time the switch is pressed.)

STEP 3 Firmly depress the brake pedal and check that the smart entry & start system indicator light (green) turns on.

STEP 4 Press the “ENGINE START STOP” switch.

In the event that the “ENGINE START STOP” switch still cannot be operated, contact any authorized Toyota dealer or repairer, or another duly qualified and equipped professional.

Vehicles with a multi-mode manual transmission

STEP 1 Ensure that the shift lever is in N and firmly depress the brake pedal.

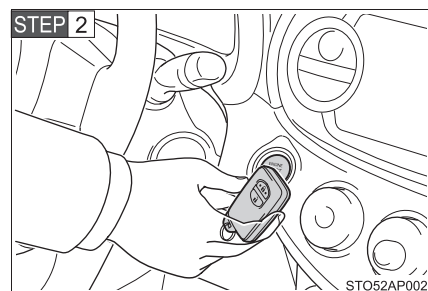

Touch the Toyota emblem side of the electronic key to the “ENGINE START STOP” switch.

The “ENGINE START STOP” switch will turn to IGNITION ON mode.

When the smart entry & start system is deactivated in customization setting, the “ENGINE START STOP” switch will turn to ACCESSORY mode. Modes can be changed by pressing the “ENGINE START STOP” switch with the brake pedal released. (The mode changes each time the switch is pressed.)

STEP 3 Firmly depress the brake pedal and check that the smart entry & start system indicator light (green) turns on.

STEP 4 Press the “ENGINE START STOP” switch.

In the event that the “ENGINE START STOP” switch still cannot be operated, contact any authorized Toyota dealer or repairer, or another duly qualified and equipped professional.

Vehicles with a manual transmission

STEP 1 Ensure that the shift lever is in N and depress the clutch pedal.

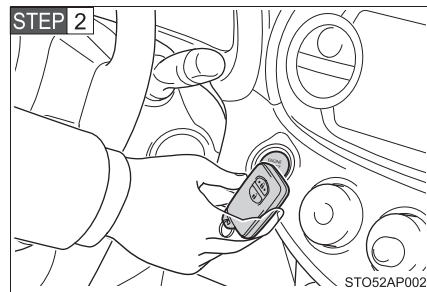

Touch the Toyota emblem side of the electronic key to the “ENGINE START STOP” switch.

The “ENGINE START STOP” switch will turn to IGNITION ON mode.

When the smart entry & start system is deactivated in customization setting, the “ENGINE START STOP” switch will turn to ACCESSORY mode. Modes can be changed by pressing the “ENGINE START STOP” switch with the clutch pedal released. (The mode changes each time the switch is pressed.)

STEP 3 Firmly depress the clutch pedal and check that the smart entry & start system indicator light (green) turns on.

STEP 4 Press the “ENGINE START STOP” switch.

In the event that the “ENGINE START STOP” switch still cannot be operated, contact any authorized Toyota dealer or repairer, or another duly qualified and equipped professional.

■ **Stopping the engine**

Vehicles with a Multidrive: Shift the shift lever to P and press the “ENGINE START STOP” switch as you normally do when stopping the engine.

Except vehicles with a Multidrive: Shift the shift lever to N and press the “ENGINE START STOP” switch as you normally do when stopping the engine.

■ **Replacing the key battery**

As the above procedure is a temporary measure, it is recommended that the electronic key battery be replaced immediately when the battery is depleted. (→P. 401)

■ **If the doors cannot be locked or unlocked by the smart entry & start system**

Lock and unlock the doors by the mechanical key or wireless remote control.

■ **When the electronic key does not work properly**

Make sure that the smart entry & start system has not been deactivated in the customization setting. If it is off, turn the function on. (Customizable features →P. 542)

5-2. Steps to take in an emergency If the vehicle battery is discharged

The following procedures may be used to start the engine if the vehicle's battery is discharged.

You can also call any authorized Toyota dealer or repairer, or another duly qualified and equipped professional.

If you have a set of jumper (or booster) cables and a second vehicle with a 12-volt battery, you can jump start your vehicle by following the steps below.

STEP 1 Open the hood. (→P. 368)

STEP 2 Connect the jumper cables according to the following procedure:

1KR-FE engine

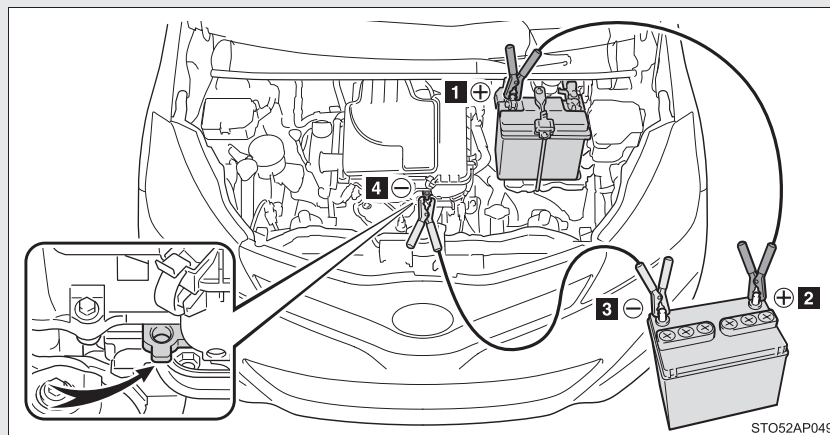

1 Connect a positive jumper cable clamp to the positive (+) battery terminal on your vehicle.

2 Connect the clamp on the other end of the positive cable to the positive (+) battery terminal on the second vehicle.

3 Connect a negative cable clamp to the negative (-) battery terminal on the second vehicle.

4 Connect the clamp at the other end of the negative cable to a solid, stationary, unpainted metallic point away from the battery and any moving parts as shown in the illustration.

1NR-FE engine

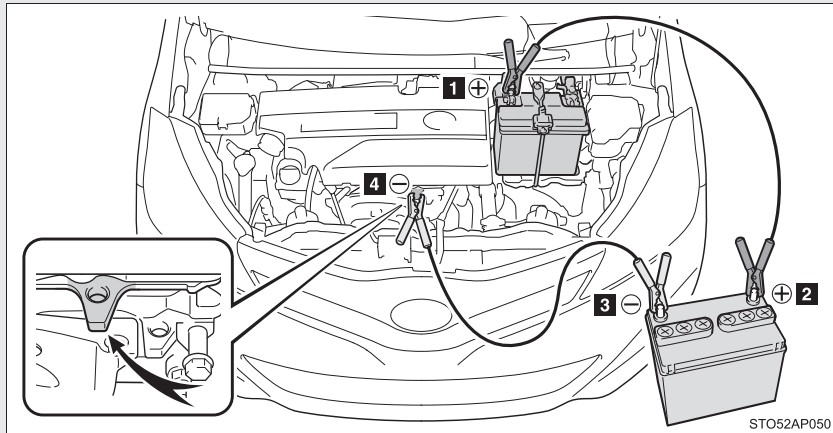

- 1** Connect a positive jumper cable clamp to the positive (+) battery terminal on your vehicle.
- 2** Connect the clamp on the other end of the positive cable to the positive (+) battery terminal on the second vehicle.
- 3** Connect a negative cable clamp to the negative (-) battery terminal on the second vehicle.
- 4** Connect the clamp at the other end of the negative cable to a solid, stationary, unpainted metallic point away from the battery and any moving parts as shown in the illustration.

1ND-TV engine

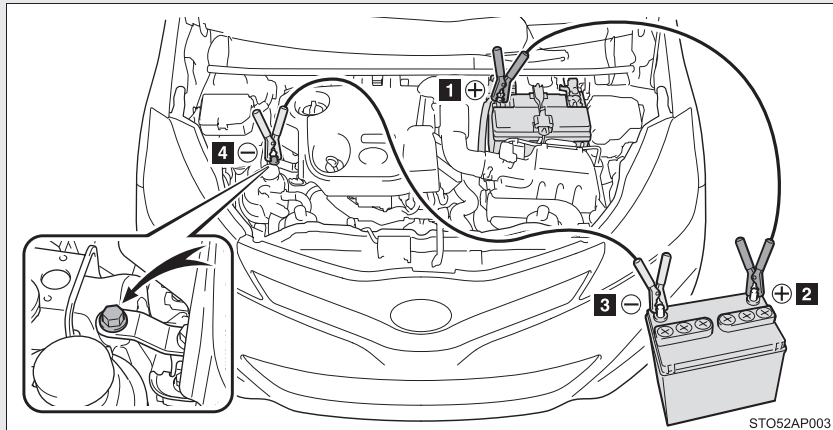

- 1** Connect a positive jumper cable clamp to the positive (+) battery terminal on your vehicle.
 - 2** Connect the clamp on the other end of the positive cable to the positive (+) battery terminal on the second vehicle.
 - 3** Connect a negative cable clamp to the negative (-) battery terminal on the second vehicle.
 - 4** Connect the clamp at the other end of the negative cable to a solid, stationary, unpainted metallic point away from the battery and any moving parts as shown in the illustration.
- STEP 3** Start the engine of the second vehicle. Increase the engine speed slightly and maintain at that level for approximately 5 minutes to recharge the battery of your vehicle.
- STEP 4** Vehicles with a smart entry & start system: Open and close any of the doors with the “ENGINE START STOP” switch turned off.

STEP 5 Vehicles without a smart entry & start system: Maintain the engine speed of the second vehicle and turn the engine switch to the “ON” position, then start the vehicle's engine.

Vehicles with a smart entry & start system: Maintain the engine speed of the second vehicle and turn the “ENGINE START STOP” switch to IGNITION ON mode, then start the vehicle's engine.

STEP 6 Once the vehicle's engine has started, remove the jumper cables in the exact reverse order from which they were connected.

Once the engine starts, have the vehicle inspected at any authorized Toyota dealer or repairer, or another duly qualified and equipped professional, as soon as possible.

■ **Starting the engine when the battery is discharged (vehicles with a Multidrive)**

The engine cannot be started by push-starting.

■ **To prevent battery discharge**

- Turn off the headlights and the audio system while the engine is off.
- Turn off any unnecessary electrical components when the vehicle is running at a low speed for an extended period, such as in heavy traffic.

■ **Charging the battery**

The electricity stored in the battery will discharge gradually even when the vehicle is not in use, due to natural discharge and the draining effects of certain electrical appliances. If the vehicle is left for a long time, the battery may discharge, and the engine may be unable to start. (The battery recharges automatically during driving.)

■ **Precautions when the battery is discharged (vehicles with a smart entry & start system)**

- In some cases, it may not be possible to unlock the doors using the smart entry & start system when the battery is discharged. Use the wireless remote control or the mechanical key to lock or unlock the doors.
- The engine may not start on the first attempt after the battery has recharged but will start normally after the second attempt. This is not a malfunction.
- The “ENGINE START STOP” switch mode is memorized by the vehicle. When the battery is reconnected, the system will return to the mode it was in before the battery was discharged. Before disconnecting the battery, turn the “ENGINE START STOP” switch off.
If you are unsure what mode the “ENGINE START STOP” switch was in before the battery discharged, be especially careful when reconnecting the battery.

 CAUTION**■ Avoiding battery fires or explosions**

Observe the following precautions to prevent accidentally igniting the flammable gas that may be emitted from the battery:

- Make sure each jumper cable is connected to the correct terminal and that it is not unintentionally in contact with any other than the intended terminal.
- Do not allow the + and - clamps of the jumper cables to come into contact with each other.
- Do not smoke, use matches, cigarette lighters or allow open flame near the battery.

■ Battery precautions

The battery contains poisonous and corrosive acidic electrolyte, while related parts contain lead and lead compounds. Observe the following precautions when handling the battery:

- When working with the battery, always wear safety glasses and take care not to allow any battery fluids (acid) to come into contact with skin, clothing or the vehicle body.
- Do not lean over the battery.
- In the event that battery fluid comes into contact with the skin or eyes, immediately wash the affected area with water and seek medical attention. Place a wet sponge or cloth over the affected area until medical attention can be received.
- Always wash your hands after handling the battery support, terminals, and other battery-related parts.
- Do not allow children near the battery.

■ To prevent damage to the vehicle

Do not pull- or push-start the vehicle as the three-way catalytic converter (gasoline-powered vehicles) or catalytic converter (diesel-powered vehicles) may overheat and become a fire hazard.

5-2. Steps to take in an emergency

 NOTICE

■ **When handling jumper cables**

When connecting the jumper cables, ensure that they do not become entangled in the cooling fans or belt.

5-2. Steps to take in an emergency If your vehicle overheats

If your engine overheats:

STEP 1 Stop the vehicle in a safe place and turn off the air conditioning system.

STEP 2 Check to see if steam is coming out from under the hood.

If you see steam:

Stop the engine. Carefully lift the hood after the steam subsides and then restart the engine.

If you do not see steam:

Leave the engine running and carefully lift the hood.

STEP 3 Check to see if the cooling fan is operating.

If the fan is operating:

Wait until the high engine coolant temperature warning light goes off and then stop the engine.

If the fan is not operating:

Stop the engine immediately and call any authorized Toyota dealer or repairer, or another duly qualified and equipped professional.

STEP 4 After the engine has cooled down sufficiently, check the engine coolant level and inspect the radiator core (radiator) for any leaks.

Gasoline engine

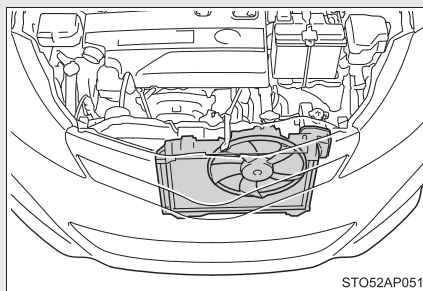

5-2. Steps to take in an emergency

Diesel engine

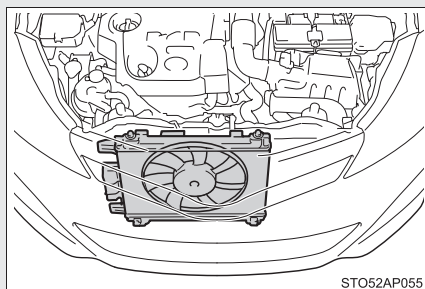

STEP 5 Add engine coolant if necessary.

Water can be used in an emergency if engine coolant is unavailable. (→P. 529)

Gasoline engine

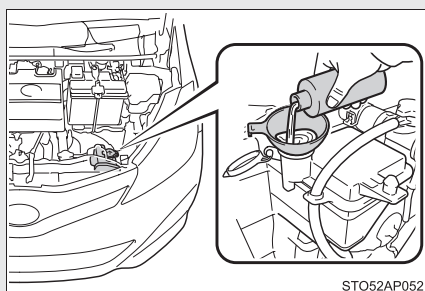

Diesel engine

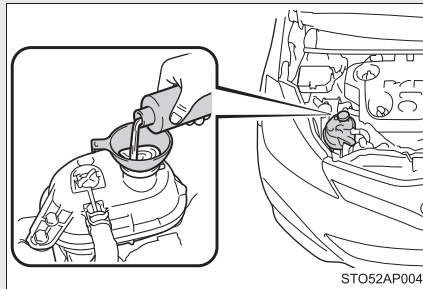

Have the vehicle inspected at the nearest authorized Toyota dealer or repairer, or another duly qualified and equipped professional as soon as possible.

■ Overheating

If you observe the following, your vehicle may be overheating:

- The high engine coolant temperature warning light flashes or comes on or a loss of power is experienced.
- Steam comes out from under the hood.

▲ CAUTION

■ To prevent an accident or injury when inspecting under the hood of your vehicle

- If steam is seen coming from under the hood, do not open the hood until the steam has subsided. The engine compartment may be very hot, causing serious injuries such as burns.
- Keep hands and clothing away from the fans and drive belt while the engine is running.
- Do not loosen the radiator cap, or the coolant reservoir cap while the engine and radiator are hot.
Serious injury, such as burns, may result from hot coolant and steam released under pressure.

5-2. Steps to take in an emergency

NOTICE

■ **When adding engine coolant**

Wait until the engine has cooled down before adding engine coolant. When adding coolant, do so slowly. Adding cool coolant to a hot engine too quickly can cause damage to the engine.

5-2. Steps to take in an emergency If you run out of fuel and the engine stalls (diesel engine only)

If you run out of fuel and the engine stalls:

STEP 1 Refuel your vehicle.

STEP 2 Pull the rubber strip on the edge to unhook it from the cover, and then push the tabs in and lift the cover off.

Left-hand drive vehicles

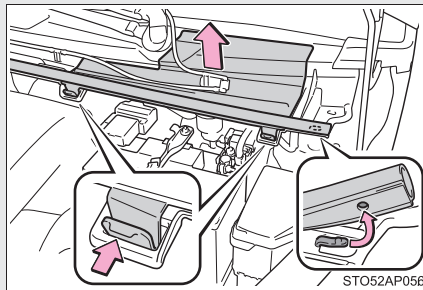

Right-hand drive vehicles

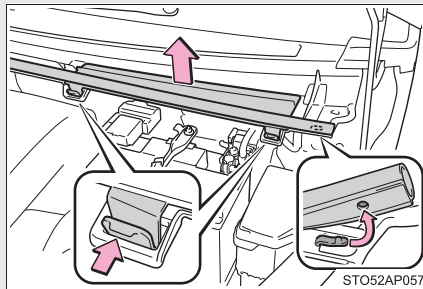

5-2. Steps to take in an emergency

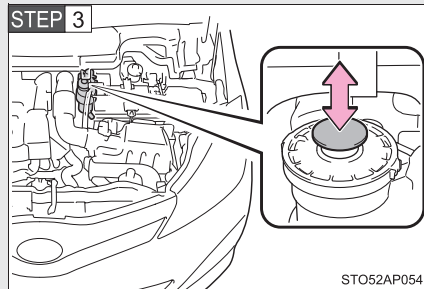

To bleed the fuel system, operate the priming pump until you feel more resistance.

STEP 4 Reinstall the cover, and then hook the rubber strip's groove onto the cover.

Left-hand drive vehicles

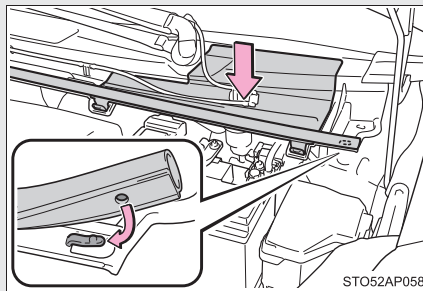

Right-hand drive vehicles

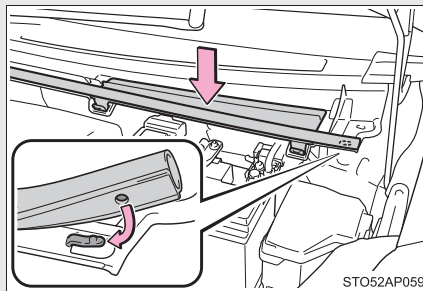

STEP 5 Start the engine. (→P. 165, 169)

If the engine does not start after the above steps have been performed, wait for 10 seconds and then try steps 3 and 5 again. If the engine still does not start, contact any authorized Toyota dealer or repairer, or another duly qualified and equipped professional.

After starting the engine, depress the accelerator pedal lightly until the engine runs smoothly.

 NOTICE

■ **When restarting the engine**

- Do not crank the engine before refueling and operating the priming pump. This may damage the engine and fuel system.
- Vehicles without a smart entry & start system: Do not crank the engine for more than 30 seconds at a time. This may overheat the starter and wiring system.

5-2. Steps to take in an emergency If the vehicle becomes stuck

Carry out the following procedures if the tires spin or the vehicle becomes stuck in mud, dirt or snow:

STEP 1 Vehicles with a Multidrive: Stop the engine. Set the parking brake and shift the shift lever to P.

Except vehicles with a Multidrive: Stop the engine. Set the parking brake and shift the shift lever to N.

STEP 2 Remove the mud, snow or sand from around the stuck tire.

STEP 3 Place wood, stones or some other material under the tires to help provide traction.

STEP 4 Restart the engine.

STEP 5 Vehicles with a Multidrive: Shift the shift lever to the D or R and carefully apply the accelerator to free the vehicle.

Vehicles with a multi-mode manual transmission: Shift the shift lever to E, M or R and carefully apply the accelerator to free the vehicle.

Vehicles with a manual transmission: Shift the shift lever to 1 or R and carefully apply the accelerator to free the vehicle.

Vehicles with VSC/TRC systems: Turn off TRC and VSC if these functions are hampering your attempts to free the vehicle.

(→P. 244)

■ Emergency hooks

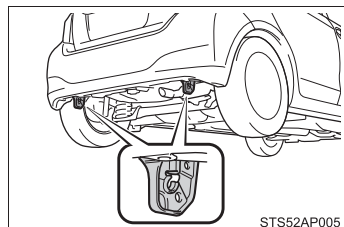

When your vehicle becomes stuck and cannot move, the emergency hooks are used for another vehicle to pull your vehicle out in an emergency.

Your vehicle is not designed to tow another vehicle.

 CAUTION**■ When attempting to free a stuck vehicle**

If you choose to push the vehicle back and forth to free it, make sure the surrounding area is clear to avoid striking other vehicles, objects or people. The vehicle may also lunge forward or lunge back suddenly as it becomes free. Use extreme caution.

■ When shifting the shift lever (except vehicles with a manual transmission)

Be careful not to shift the shift lever with the accelerator pedal depressed. This may lead to unexpected rapid acceleration of the vehicle that may cause an accident resulting in death or serious injury.

 NOTICE**■ To avoid damage to the transmission and other components**

- Avoid spinning the wheels and depressing the accelerator pedal more than necessary.
- If the vehicle remains stuck even after these procedures are performed, the vehicle may require towing to be freed.

5-2. Steps to take in an emergency

If your vehicle has to be stopped in an emergency

Only in an emergency, such as if it becomes impossible to stop the vehicle in the normal way, stop the vehicle using the following procedure:

STEP 1 Steadily step on the brake pedal with both feet and firmly depress it.

Do not pump the brake pedal repeatedly as this will increase the effort required to slow the vehicle.

STEP 2 Shift the shift lever to N.

If the shift lever is shifted to N

STEP 3 After slowing down, stop the vehicle in a safe place by the road.

STEP 4 Stop the engine.

If the shift lever cannot be shifted to N

STEP 3 Keep depressing the brake pedal with both feet to reduce vehicle speed as much as possible.

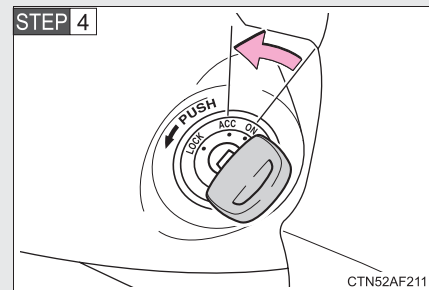

Vehicles without a smart entry & start system: Stop the engine by turning the engine switch to the “ACC” position.

STEP 4

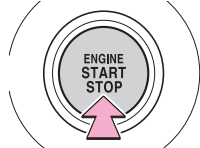

Press and hold for 3 seconds or more,
or press briefly for 3 times or more

CTY52AD212

Vehicles with a smart entry & start system: To stop the engine, press and hold the “ENGINE START STOP” switch for 3 consecutive seconds or more, or press it briefly for 3 times or more in succession.

STEP 5

Stop the vehicle in a safe place by the road.

⚠ CAUTION

■ **If the engine has to be turned off while driving**

- Power assist for the brakes and steering wheel will be lost, making the brake pedal harder to depress and the steering wheel heavier to turn. Decelerate as much as possible before turning off the engine.
- Vehicles without a smart entry & start system: Never attempt to remove the key, as doing so will lock the steering wheel.

5-2. Steps to take in an emergency

516

Vehicle specifications

6

6-1. Specifications

Maintenance data (fuel, oil level, etc.).....	518
Fuel information	539

6-2. Customization

Customizable features	542
-----------------------------	-----

6-1. Specifications

Maintenance data (fuel, oil level, etc.)

Dimensions and weights

Overall length		3885 mm (153.0 in.)
Overall width		1695 mm (66.7 in.)
Overall height* ¹		1515 mm (59.6 in.)
Wheelbase		2510 mm (98.8 in.)
Tread	Front	1485 mm (58.5 in.) ^{*1} 1470 mm (57.9 in.) ^{*2} 1460 mm (57.5 in.) ^{*3}
	Rear	1470 mm (57.9 in.) ^{*1} 1460 mm (57.5 in.) ^{*2} 1450 mm (57.1 in.) ^{*3}
Gross vehicle mass	1KR-FE engine	1430 kg (3153 lb.)
	1NR-FE engine	Vehicles with a Multidrive 1480 kg (3263 lb.) Vehicles with a manual transmission 1470 kg (3241 lb.)
	1ND-TV engine	Vehicles with a multi-mode manual transmission 1530 kg (3373 lb.) Vehicles with a manual transmission 1525 kg (3362 lb.)
Maximum permissible axle capacity	Front	1KR-FE engine 825 kg (1819 lb.) 1NR-FE engine 850 kg (1874 lb.) 1ND-TV engine 895 kg (1973 lb.)
	Rear	825 kg (1819 lb.)
Drawbar load		50 kg (110 lb.)

Towing capacity (except South Africa)	Vehicles with a brake	1KR-FE engine 750 kg (1653 lb.) 1NR-FE engine 900 kg (1984 lb.) 1ND-TV engine 1050 kg (2315 lb.)
	Vehicles without a brake	550 kg (1213 lb.)

*1: 175/65R14, 175/70R14 or 175/65R15 tires

*2: 185/60R15 tires

*3: 195/50R16 tires

Vehicle identification

■ Vehicle identification number

The vehicle identification number (VIN) is the legal identifier for your vehicle. This is the primary identification number for your Toyota. It is used in registering the ownership of your vehicle.

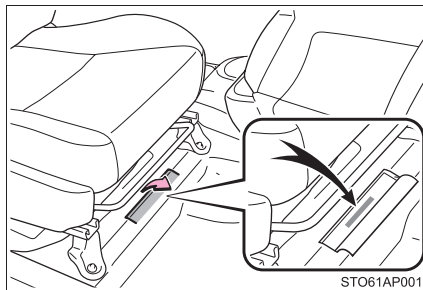

This number is stamped under the right-hand front seat.

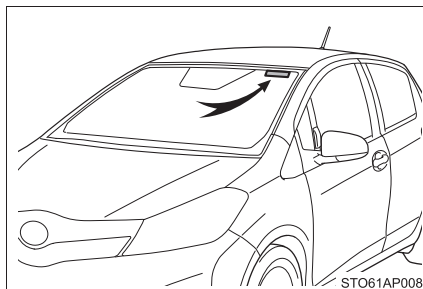

For South Africa: This number is also stamped on the top left of the windshield glass.

6-1. Specifications

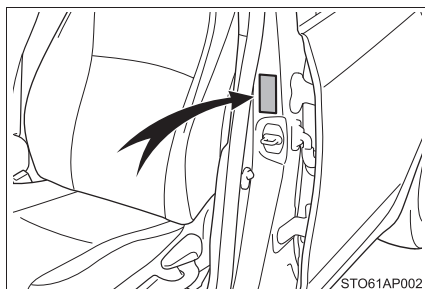

This number is also on the manufacturer's label on the left-hand side center pillar.

■ Engine number

The engine number is stamped on the engine block as shown.

1KR-FE engine

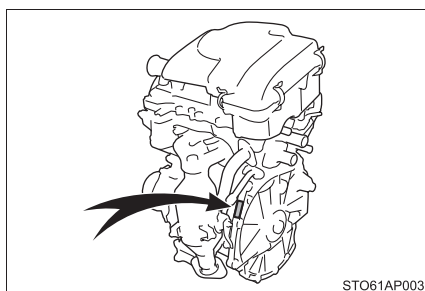

1NR-FE engine

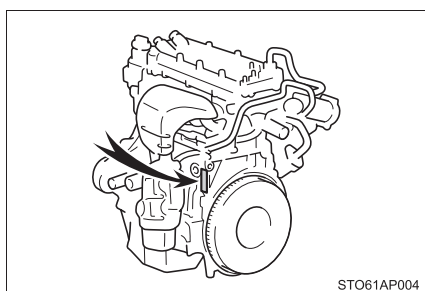

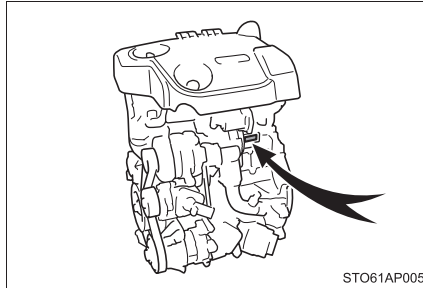
1ND-TV engine**Engine****Gasoline engine**

Model	1KR-FE and 1NR-FE
Type	1KR-FE engine 3-cylinder in line, 4-cycle, gasoline 1NR-FE engine 4-cylinder in line, 4-cycle, gasoline
Bore and stroke	1KR-FE engine 71.0 × 84.0 mm (2.79 × 3.30 in.) 1NR-FE engine 72.5 × 80.5 mm (2.85 × 3.17 in.)
Displacement	1KR-FE engine 998 cm ³ (60.9 cu.in.) 1NR-FE engine 1329 cm ³ (81.1 cu.in.)
Valve clearance (engine cold)	1KR-FE engine Intake: 0.145 — 0.235 mm (0.006 — 0.009 in.) Exhaust: 0.275 — 0.365 mm (0.011 — 0.014 in.) 1NR-FE engine Automatic adjustment

6-1. Specifications

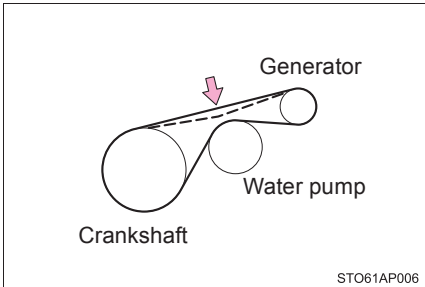
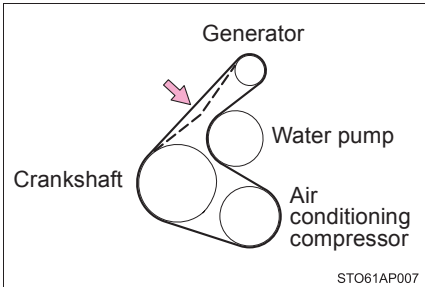
Drive belt tension	<p>1KR-FE engine 9.0 — 11.0 mm (0.35 — 0.43 in.)* Vehicles without an air conditioning system:</p>  <p style="text-align: right; font-size: small;">STO61AP006</p>
	<p>Vehicles with an air conditioning system:</p>  <p style="text-align: right; font-size: small;">STO61AP007</p> <p>1NR-FE engine Automatic adjustment</p>

*: Drive belt deflection with 98 N (10 kgf, 22 lbf) thumb force (used belt)

Diesel engine

Model	1ND-TV
Type	4-cylinder in line, 4-cycle, diesel
Bore and stroke	73.0 × 81.5 mm (2.87 × 3.21 in.)
Displacement	1364 cm ³ (83.2 cu.in.)
Valve clearance (engine cold)	Intake: 0.11 — 0.17 mm (0.004 — 0.007 in.) Exhaust: 0.14 — 0.20 mm (0.006 — 0.008 in.)
Drive belt tension	Automatic adjustment

 NOTICE

■ **Drive belt type (diesel engine)**

The high strength drive belt is used for the generator side drive belt. When replacing the drive belt, use Toyota genuine drive belt or equivalent high strength drive belt. If the high strength drive belt is not used, durability of the belt may become less than expected. The high strength drive belt is a belt with Aramid core which has higher strength compared to usually available belts with PET or PEN core.

Fuel

Gasoline engine

Fuel type	EU area: Unleaded gasoline conforming to European standard EN228 only Except EU area: Unleaded gasoline only
Research octane number	95 or higher
Fuel tank capacity (Reference)	42 L (11.1 gal., 9.2 Imp. gal.)

Diesel engine

Fuel type	EU area: Diesel fuel conforming to European standard EN590 Except EU area: Diesel fuel that contains 50 ppm or less of sulfur
Cetane number	48 or higher
Fuel tank capacity (Reference)	42 L (11.1 gal., 9.2 Imp. gal.)

Lubrication system

Oil capacity (Drain and refill — reference*)	
With filter	1KR-FE engine 3.1 L (3.3 qt., 2.7 Imp. qt.) 1NR-FE engine 3.4 L (3.6 qt., 3.0 Imp. qt.) 1ND-TV engine 3.9 L (4.1 qt., 3.4 Imp. qt.)
Without filter	1KR-FE engine 2.9 L (3.1 qt., 2.6 Imp. qt.) 1NR-FE engine 3.2 L (3.4 qt., 2.8 Imp. qt.) 1ND-TV engine 3.5 L (3.7 qt., 3.1 Imp. qt.)

*: The engine oil capacity is a reference quantity to be used when exchanging. Warm up and turn off the engine, wait more than 5 minutes, and check the oil level on the dipstick.

■ Engine oil selection

“Toyota Genuine Motor Oil” is used in your Toyota vehicle. Toyota recommends the use of approved “Toyota Genuine Motor Oil”. Another motor oil of matching quality can also be used.

Gasoline engines

Oil grade:

0W-20, 5W-20, 5W-30 and 10W-30:

API grade SL “Energy-Conserving”, SM “Energy-Conserving” or ILSAC multigrade engine oil

15W-40 and 20W-50:

API grade SL or SM multigrade engine oil

Recommended viscosity (SAE):

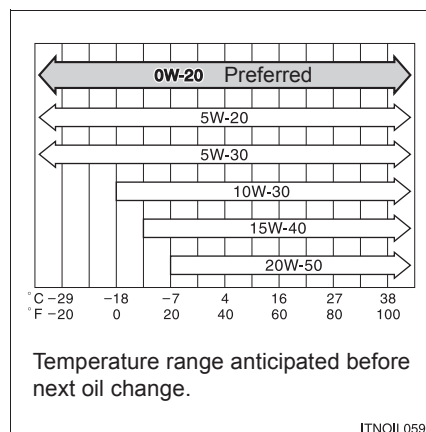

SAE 0W-20 is filled into your Toyota vehicle at manufacturing, and the best choice for good fuel economy and good starting in cold weather.

If SAE 0W-20 oil is not available, SAE 5W-30 oil may be used. However, it should be replaced with SAE 0W-20 at the next oil change.

If you use SAE 10W-30 or a higher viscosity engine oil in extremely low temperatures, the engine may become difficult to start, so SAE 5W-30 or lower viscosity engine oil is recommended.

6-1. Specifications

Oil viscosity (0W-20 is explained here as an example):

- The 0W in 0W-20 indicates the characteristic of the oil which allows cold startability. Oils with a lower value before the W allow for easier starting of the engine in cold weather.
- The 20 in 0W-20 indicates the viscosity characteristic of the oil when the oil is at high temperature. An oil with a higher viscosity (one with a higher value) may be better suited if the vehicle is operated at high speeds, or under extreme load conditions.

How to read oil container labels:

Either or both API registered marks are added to some oil containers to help you select the oil you should use.

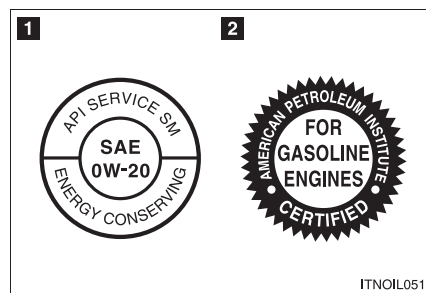

1 API Service Symbol

Top portion: The oil quality designation by API (American Petroleum Institute) (SM)

Center portion: The SAE viscosity grade (SAE 0W-20)

Lower portion: “Energy-Conserving” means that the oil has fuel-saving capabilities.

2 ILSAC Certification Mark

The ILSAC (International Lubricant Standardization and Approval Committee) Certification Mark is displayed on the front of the container.

Diesel engine vehicles without a DPF system*

Oil grade: ACEA C2, B1, API CF-4 or CF
(You may also use API CE or CD.)

Recommended viscosity (SAE):

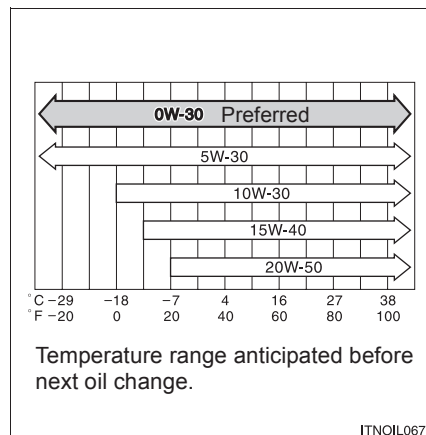

SAE 0W-30 is filled into your Toyota vehicle at manufacturing, and the best choice for good fuel economy and good starting in cold weather.

If you use SAE 10W-30 or a higher viscosity engine oil in extremely low temperatures, the engine may become difficult to start, so SAE 5W-30 or 0W-30 engine oil is recommended.

Oil viscosity (0W-30 is explained here as an example):

- The 0W in 0W-30 indicates the characteristic of the oil which allows cold startability. Oils with a lower value before the W allow for easier starting of the engine in cold weather.
- The 30 in 0W-30 indicates the viscosity characteristic of the oil when the oil is at high temperature. An oil with a higher viscosity (one with a higher value) may be better suited if the vehicle is operated at high speeds, or under extreme load conditions.

*: To determine whether or not your vehicle has a DPF system, contact any authorized Toyota dealer or repairer, or another duly qualified and equipped professional.

Diesel engine vehicles with a DPF system*

Oil grade: ACEA C2

 NOTICE

Using engine oil other than ACEA C2 may damage the catalytic converter.

Recommended viscosity (SAE):

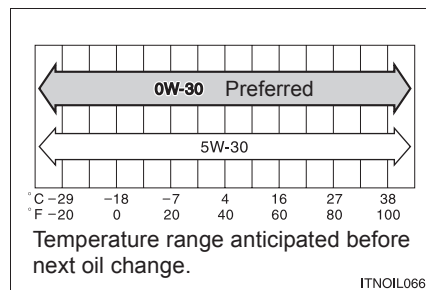

SAE 0W-30 is filled into your Toyota vehicle at manufacturing, and the best choice for good fuel economy and good starting in cold weather.

Oil viscosity (0W-30 is explained here as an example):

- The 0W in 0W-30 indicates the characteristic of the oil which allows cold startability. Oils with a lower value before the W allow for easier starting of the engine in cold weather.
- The 30 in 0W-30 indicates the viscosity characteristic of the oil when the oil is at high temperature. An oil with a higher viscosity (one with a higher value) may be better suited if the vehicle is operated at high speeds, or under extreme load conditions.

*: To determine whether or not your vehicle has a DPF system, contact any authorized Toyota dealer or repairer, or another duly qualified and equipped professional.

Cooling system

Capacity (Reference)	1KR-FE engine	4.5 L (4.8 qt., 4.0 Imp. qt.)
	1NR-FE engine	Vehicles with a Multidrive 4.8 L (5.1 qt., 4.1 Imp. qt.) Vehicles with a manual transmission 4.6 L (4.9 qt., 4.0 Imp. qt.)
	1ND-TV engine	Vehicles without a power heater 4.5 L (4.8 qt., 4.0 Imp. qt.) Vehicles with a power heater 4.9 L (5.2 qt., 4.3 Imp. qt.)
Coolant type		Use either of the following: <ul style="list-style-type: none"> • “Toyota Super Long Life Coolant” • A similar high-quality ethylene glycol-based non-silicate, non-amine, non-nitrite, and non-borate coolant with long-life hybrid organic acid technology Do not use plain water alone.

Ignition system (gasoline engine only)

Spark plug Make	1KR-FE engine DENSO SK16HR11 1NR-FE engine DENSO SC20HR11
Gap	1.1 mm (0.043 in.)

 NOTICE**■ Iridium-tipped spark plugs**

Use only iridium-tipped spark plugs. Do not adjust the spark plug gap.

Electrical system

Battery	12.6 — 12.8 V Fully charged 12.2 — 12.4 V Half charged 11.8 — 12.0 V Discharged (*: Voltage checked 20 minutes after the engine and all the lights turned off)
Open voltage* at 20°C (68°F):	
Charging rates	5 A max.

Multidrive

Fluid capacity*	6.5 L (6.9 qt., 5.7 Imp. qt.)
Fluid type	Toyota Genuine CVT Fluid TC

*: The fluid capacity is the quantity of reference. If replacement is necessary, contact any authorized Toyota dealer or repairer, or another duly qualified and equipped professional.

 NOTICE**■ Multidrive fluid type**

Using Multidrive fluid other than “Toyota Genuine CVT Fluid TC” may cause deterioration in shift quality, locking up of your transmission accompanied by vibration, and ultimately damage the transmission of your vehicle.

Manual transmission

Gear oil capacity (Reference)	1KR-FE engine 1.7 L (1.8 qt., 1.5 Imp. qt.) 1NR-FE and 1ND-TV engines 2.4 L (2.5 qt., 2.1 Imp. qt.)
Gear oil type	Use either of the following: <ul style="list-style-type: none"> • “TOYOTA Genuine Manual Transmission Gear Oil LV” • Other gear oil that meets API GL-4 and SAE 75W specifications

 **NOTICE**
 **Manual transmission gear oil**

Please be aware that depending on the particular characteristics of the gear oil used or the operating conditions, idle sound, shift feeling and/or fuel efficiency may be different or affected. Toyota recommends to use “TOYOTA Genuine Manual Transmission Gear Oil LV” to achieve optimal performance.

Clutch

Pedal free play	5 — 15 mm (0.2 — 0.6 in.)
Fluid type	SAE J1704 or FMVSS No.116 DOT 4

Brakes

Pedal clearance*1	Left-hand drive vehicles	Gasoline engines	Vehicles with a rear drum brake 83 mm (3.27 in.) Min. Vehicles with a rear disc brake 79 mm (3.11 in.) Min.
		Diesel engines	Vehicles with a rear drum brake 81 mm (3.19 in.) Min. Vehicles with a rear disc brake 78 mm (3.07 in.) Min.
	Right-hand drive vehicles	Gasoline engines	Vehicles with a rear drum brake 76 mm (2.99 in.) Min. Vehicles with a rear disc brake 74 mm (2.91 in.) Min.
		Diesel engines	Vehicles with a rear drum brake 75 mm (2.95 in.) Min. Vehicles with a rear disc brake 73 mm (2.87 in.) Min.
Pedal free play			1 — 6 mm (0.04 — 0.24 in.)
Parking brake lever travel *2			Vehicles with a rear drum brake 5 — 7 clicks Vehicles with a rear disc brake 4 — 6 clicks
Fluid type			SAE J1704 or FMVSS No.116 DOT 4

*1: Minimum pedal clearance when depressed with a force of 300 N (31 kgf, 67.4 lbf) while the engine is running

*2: Parking brake lever travel when pulled up with a force of 200 N (20.4 kgf, 45.0 lbf)

Steering

Free play	Less than 30 mm (1.2 in.)
-----------	---------------------------

Tires and wheels**Type A**

Tire size	175/65R14 82T	
Tire inflation pressure (Recommended cold tire inflation pressure)	Front wheel kPa (kgf/cm ² or bar, psi)	Rear wheel kPa (kgf/cm ² or bar, psi)
	220 (2.2, 32)	220 (2.2, 32)
Wheel size	14 × 5J	
Wheel nut torque	103 N·m (10.5 kgf·m, 76 ft·lbf)	

Type B

Tire size	175/65R14 82T, T125/70D15 95M (compact spare)	
Tire inflation pressure (Recommended cold tire inflation pressure)	Front wheel kPa (kgf/cm ² or bar, psi)	Rear wheel kPa (kgf/cm ² or bar, psi)
	220 (2.2, 32)	220 (2.2, 32)
Tire inflation pressure (compact spare) (Recommended cold tire inflation pressure)	420 kPa (4.2 kgf/cm ² or bar, 60 psi)	
Wheel size	14 × 5J, 15 × 4B (compact spare)	
Wheel nut torque	103 N·m (10.5 kgf·m, 76 ft·lbf)	

6-1. Specifications

Type C

Tire size	175/70R14 84S, T125/70D16 96M (compact spare)*1	
Tire inflation pressure (Recommended cold tire inflation pressure)	Front wheel kPa (kgf/cm ² or bar, psi)	Rear wheel kPa (kgf/cm ² or bar, psi)
	250 (2.5, 36)	240 (2.4, 35)
Tire inflation pressure (compact spare) (Recommended cold tire inflation pressure)	420 kPa (4.2 kgf/cm ² or bar, 60 psi)	
Wheel size	14 × 5J, 16 × 4T (compact spare)*1	
Wheel nut torque	103 N·m (10.5 kgf·m, 76 ft·lbf)	

*1: Vehicles without an emergency tire puncture repair kit.

Type D

Tire size	175/65R15 84H, T125/70D16 96M (compact spare)*1	
Tire inflation pressure (Recommended cold tire inflation pressure)	Front wheel kPa (kgf/cm ² or bar, psi)	Rear wheel kPa (kgf/cm ² or bar, psi)
	Standard tire pressure: 230 (2.3, 33) ECO tire pressure*2: 250 (2.5, 36)	Standard tire pressure: 220 (2.2, 32) ECO tire pressure*2: 240 (2.4, 35)
Tire inflation pressure (compact spare) (Recommended cold tire inflation pressure)	420 kPa (4.2 kgf/cm ² or bar, 60 psi)	
Wheel size	15 × 5J, 16 × 4T (compact spare)*1	
Wheel nut torque	103 N·m (10.5 kgf·m, 76 ft·lbf)	

*1: Vehicles without an emergency tire puncture repair kit.

*2: Eco tire pressure is shown on the tire pressure label. (→P. 479)
“For optimizing fuel economy, ECO tire pressure is recommended.
Tire pressure affects traveling comfort, road noise and steering characteristics.”

6-1. Specifications

Type E

Tire size	185/60R15 84H		
Tire inflation pressure (Recommended cold tire inflation pressure)	Vehicle speed	Front wheel kPa (kgf/cm ² or bar, psi)	Rear wheel kPa (kgf/cm ² or bar, psi)
	160 km/h (99 mph) or less	220 (2.2, 32)	220 (2.2, 32)
	More than 160 km/h (99 mph)	240 (2.4, 35)	220 (2.2, 32)
Wheel size	15 × 5 1/2J		
Wheel nut torque	103 N·m (10.5 kgf·m, 76 ft·lbf)		

Type F

Tire size	185/60R15 84H, T125/70D15 95M (compact spare)		
Tire inflation pressure (Recommended cold tire inflation pressure)	Vehicle speed	Front wheel kPa (kgf/cm ² or bar, psi)	Rear wheel kPa (kgf/cm ² or bar, psi)
	160 km/h (99 mph) or less	220 (2.2, 32)	220 (2.2, 32)
	More than 160 km/h (99 mph)	240 (2.4, 35)	220 (2.2, 32)
Tire inflation pressure (compact spare) (Recommended cold tire inflation pressure)	420 kPa (4.2 kgf/cm ² or bar, 60 psi)		
Wheel size	15 × 5 1/2J, 15 × 4B (compact spare)		
Wheel nut torque	103 N·m (10.5 kgf·m, 76 ft·lbf)		

Type G

Tire size	195/50R16 84V, T125/70D16 96M (compact spare)		
Tire inflation pressure (Recommended cold tire inflation pressure)	Vehicle speed	Front wheel kPa (kgf/cm ² or bar, psi)	Rear wheel kPa (kgf/cm ² or bar, psi)
	160 km/h (99 mph) or less	220 (2.2, 32)	200 (2.0, 29)
	More than 160 km/h (99 mph)	240 (2.4, 35)	210 (2.1, 30)
Tire inflation pressure (compact spare) (Recommended cold tire inflation pressure)	420 kPa (4.2 kgf/cm ² or bar, 60 psi)		
Wheel size	16 × 6J, 16 × 4T (compact spare)		
Wheel nut torque	103 N·m (10.5 kgf·m, 76 ft·lbf)		

6-1. Specifications

Light bulbs

	Light Bulbs	W	Type
Exterior	Headlights	60/55	A
	Front fog lights (if equipped)		
	Type A*	55	B
	Type B*	19	H
	Front position lights	5	C
	Front turn signal lights	21	F
	Side turn signal light	5	D
	Back-up lights	16	C
	Rear fog light	21	G
	Stop/tail lights	21/5	G
Interior	License plate lights	5	C
	Rear turn signal lights	21	F
	Vanity lights (if equipped)	5	E
	Personal lights/interior light	5	C
	Luggage compartment light	5	E

A: H4 halogen bulbs

B: H11 halogen bulbs

C: Wedge base bulbs (clear)

D: Wedge base bulbs (amber)

E: Double end bulbs

F: Single end bulbs (amber)

G: Single end bulbs (clear)

H: H16 halogen bulbs

*: Replace the bulb with one of the same bulb as the original.

6-1. Specifications

Fuel information

Gasoline engine

EU area:

Your vehicle must use only unleaded gasoline conforming to European standard EN228.

For optimum engine performance, select unleaded gasoline with a Research Octane Number of 95 or higher.

Except EU area:

Your vehicle must use only unleaded gasoline.

For optimum engine performance, select unleaded gasoline with a Research Octane Number of 95 or higher.

Diesel engine

EU area:

Your vehicle must use only diesel fuel conforming to European standard EN590.

Except EU area:

Your vehicle must use only diesel fuel that contains 50 ppm or less of sulfur and has a cetane number of 48 or higher.

■ Fuel tank opening for unleaded gasoline

To help prevent incorrect fueling, your vehicle has a fuel tank opening that only accommodates the special nozzle on unleaded fuel pumps.

■ If you plan to drive in foreign countries

Low sulfur diesel fuel may not be available, so please check the availability with your distributor.

■ If your engine knocks

- Consult any authorized Toyota dealer or repairer, or another duly qualified and equipped professional.
- You may occasionally notice light knocking for a short time while accelerating or driving uphill. This is normal and there is no need for concern.

 NOTICE

■ **Notice on fuel quality (gasoline engine)**

- Do not use improper fuels. If improper fuels are used, the engine will be damaged.
- Do not use leaded gasoline.
Leaded gasoline will cause the three-way catalytic converter to lose its effectiveness and the emission control system to function improperly.
- EU area: Bioethanol fuel sold under names such as “E50” or “E85” and fuel containing a large amount of ethanol should not be used. The use of these fuels will damage the vehicle's fuel system. In case of any doubt, ask any authorized Toyota dealer or repairer, or another duly qualified and equipped professional.
- Except EU area: Bioethanol fuel sold under names such as “E50” or “E85” and fuel containing a large amount of ethanol should not be used. Your vehicle can use gasoline mixed with 10% max ethanol. The use of fuel with more than 10% ethanol content (E10) will damage the vehicle's fuel system. You must ensure that refueling is carried out only from a source where fuel specification and quality can be guaranteed. In case of any doubt, ask any authorized Toyota dealer or repairer, or another duly qualified and equipped professional.

 NOTICE**■ Notice on fuel quality (diesel engine)**

- Do not use improper fuels. If improper fuels are used, the engine will be damaged.
- Do not use a fuel that contains more than 50 ppm of sulfur. Use of such a high sulfur fuel may damage the engine.
- EU area: FAME (Fatty Acid Methyl Ester) fuel sold under names such as “B30” or “B100” and fuel containing a large amount of FAME should not be used. The use of these fuels will damage the vehicle's fuel system. In case of any doubt, ask any authorized Toyota dealer or repairer, or another duly qualified and equipped professional.
- Except EU area: FAME (Fatty Acid Methyl Ester) fuel sold under names such as “B30” or “B100” and fuel containing a large amount of FAME should not be used. Your vehicle can use diesel mixed with 5% max biodiesel FAME (B5). The use of fuel with more than 5% FAME content (B5) will damage the vehicle's fuel system. You must ensure that refueling is carried out only from a source where fuel specification and quality can be guaranteed. In case of any doubt, ask any authorized Toyota dealer or repairer, or another duly qualified and equipped professional.

6-2. Customization

Customizable features

Your vehicle includes a variety of electronic features that can be personalized to suit your preferences. Programming these preferences requires specialized equipment and may be performed by any authorized Toyota dealer or repairer, or another duly qualified and equipped professional.

Some function settings are changed simultaneously with other functions being customized. Contact any authorized Toyota dealer or repairer, or another duly qualified and equipped professional for further details.

Customizable Features

1 Vehicles with “touch screen”: Settings that can be changed using the “touch screen”

(For further information on customizing settings using the “touch screen”, refer to the ““touch screen” Owner’s Manual”.)

2 Settings that can be changed by any authorized Toyota dealer or repairer, or another duly qualified and equipped professional for further details

Definition of symbols: O = Available, — = Not available

Item	Function	Default setting	Customized setting	1	2
Smart entry & start system (→P. 44)	Smart entry & start system	ON	OFF	—	O
	Operation signal (Emergency flashers)	ON	OFF	—	O
	Time elapsed before automatic door lock function is activated if door is not opened after being unlocked	30 seconds	60 seconds	—	O
			120 seconds	—	O

Item	Function	Default setting	Customized setting	1	2
Smart entry & start system (→P. 44)	Open door warning function (when locking the vehicle)	ON	OFF	—	O
Wireless remote control (→P. 61)	Time elapsed before automatic door lock function is activated if door is not opened after being unlocked	30 seconds	60 seconds	—	O
			120 seconds	—	O
	Operation signal (Emergency flashers)	ON	OFF	—	O
Automatic light control system (→P. 214)	Light sensor sensitivity	Level 3	Level 1 to 5	O	O
Lights (→P. 214)	Daytime running light system (if equipped)	ON	OFF	O	O
	Time that the low beam headlights are on when the vehicle is parked	30 seconds	60 seconds	—	O
			90 seconds		
120 seconds					

6-2. Customization

Item	Function	Default setting	Customized setting	1	2
Illumination (→P. 328)	Time elapsed before the interior lights turn off	15 seconds	7.5 seconds	—	○
			30 seconds	—	○
	Operation when the doors are unlocked	ON	OFF	—	○
	Operation after the engine switch is turned OFF	ON	OFF	—	○
	Operation when you approach the vehicle with the electronic key on your person*	ON	OFF	—	○
	Footwell lighting	ON	OFF	—	○

*: Vehicles with smart entry & start system

Index

Abbreviation list 546

Alphabetical index..... 547

What to do if... 555

Abbreviation list**Abbreviation/Acronym list**

ABBREVIATIONS	MEANING
A/C	Air Conditioning
ABS	Anti-lock Brake System
ACC	Accessory
CRS	Child Restraint System
DPF	Diesel Particulate Filter system
ECU	Electronic Control Unit
ELR	Emergency Locking Retractor
EPS	Electric Power Steering
GVM	Gross Vehicle Mass
LED	Light Emitting Diode
MPAC	Maximum Permissible Axle Capacity
PEN	Polyethylene Naphthalate
PET	Polyethylene Terephthalate
PTC	Positive Temperature Coefficient
SRS	Supplemental Restraint System
TRC	Traction Control
VIN	Vehicle Identification Number
VSC	Vehicle Stability Control

Alphabetical index

Alphabetical index

A	A/C	268, 275
	ABS	243
	Air conditioning filter	398
	Air conditioning system	
	Air conditioning filter.....	398
	Automatic air conditioning system	275
	Manual air conditioning system	268
	Airbags	
	Airbag manual on-off system	122
	Airbag operating conditions	113
	Airbag precautions for your child	117
	Airbag warning light	447
	Curtain shield airbag operating conditions	113
	Curtain shield airbag precautions	117
	General airbag precautions...	117
	Locations of airbags.....	111
	Modification and disposal of airbags.....	121
	Proper driving posture... 109, 117	
	Side airbag operating conditions	113
	Side airbag precautions	117
	SRS airbags.....	111
	Antenna	295
	Anti-lock brake system	243
	Armrest	345
	Ashtray	340
	Audio input	324

Audio system	
Antenna	295
Audio input.....	324
AUX port.....	324
CD player.....	296
iPod.....	307
MP3/WMA disc	301
Optimal use.....	322
Portable music player	324
Radio	292
Steering wheel audio switch	325
Type.....	287
USB memory	315
Automatic air conditioning system	275
Automatic light control system	214
AUX port	324
Auxiliary box	349
B	
Back door	71
Back-up lights	
Replacing light bulbs.....	422
Wattage	538
Battery	
Checking.....	384
If the vehicle has a discharged battery.....	498
Preparing and checking before winter.....	252
Bluetooth® audio*	
Bluetooth® phone*	
Bottle holders	334
Brake	
Fluid	532
Parking brake.....	195
Brake assist	243
Break-in tips	153

*. Refer to “touch screen” Owner’s Manual”.

	Brightness control				
	Instrument panel light control.....	212			
C	Care				
	Exterior.....	354			
	Interior.....	359			
	Seat belts.....	360			
	CD player.....	296			
	Chains.....	252			
	Child-protectors.....	69			
	Child restraint system				
	Baby seats, definition.....	125			
	Baby seats, installation.....	134			
	Child seats, definition.....	125			
	Child seats, installation.....	134			
	Installing CRS with ISOFIX rigid anchors.....	138			
	Installing CRS with seat belts.....	135			
	Installing CRS with top straps.....	139			
	Junior seats, definition.....	125			
	Junior seats, installation.....	134			
	Child safety				
	Airbag precautions.....	117			
	Battery precautions.....	386, 503			
	Child-protectors.....	69			
	Child restraint system.....	125			
	How your child should wear the seat belt.....	88			
	Installing child restraints.....	134			
	Power window lock switch.....	97			
	Power window precautions.....	99			
	Removed key battery precautions.....	404			
	Seat belt precautions.....	89			
	Seat heater precautions.....	344			
	Cigarette lighter.....	341			
	Cleaning				
	Exterior.....	354			
	Interior.....	359			
	Seat belts.....	360			
	Clock.....	338			
	Condenser.....	384			
	Cooling system				
	Engine overheating.....	505			
	Cruise control				
	Cruise control.....	228			
	Indicator.....	228			
	Cup holders.....	333			
	Curtain shield airbags.....	111			
	Customizable features.....	542			
D	Daytime running light system.....	217			
	Deck board.....	349			
	Defogger				
	Rear window.....	285			
	Side mirror.....	285			
	Dimension.....	518			
	Display				
	Trip information.....	208			
	Do-it-yourself maintenance	365			
	Doors				
	Back door.....	71			
	Door glasses.....	97			
	Door lock.....	44, 61, 67			
	Double locking system.....	107			
	Side doors.....	67			
	Side mirrors.....	94			
	DPF				
	Diesel Particulate Filter system.....	248			
	Warning light.....	447			

Driver's seat belt reminder light	449
Driving	
Break-in tips	153
Correct posture	109
Procedures.....	148
Winter driving tips	252
E Electric power steering	243
Electronic key	
If the electronic key does not operate properly	494
Replacing the battery	401
Emergency flashers	
Switch	434
Emergency, in case of	
If the electronic key does not operate properly	494
If the engine will not start	488
If the shift lever cannot be shifted	492
If the shift lever cannot be shifted from P	491
If the vehicle has a discharged battery	498
If the warning buzzer sounds	444
If the warning light turns on.....	444
If you have a flat tire	459, 471
If you lose your keys	493
If you run out of fuel and the engine stalls.....	509
If you think something is wrong.....	442
If your vehicle becomes stuck	512

If your vehicle has to be stopped in an emergency.....	514
If your vehicle needs to be towed.....	435
If your vehicle overheats.....	505
Emergency tire puncture repair kit	471
Engine	
Compartment	373
Engine switch.....	165, 169
Hood	368
How to start the engine.....	165, 169
Identification number	519
If the engine will not start.....	488
If you run out of fuel and the engine stalls	509
Ignition switch	165, 169
Overheating	505
Engine coolant	
Capacity	529
Checking.....	382
Preparing and checking before winter.....	252
Engine immobilizer system	104
Engine oil	
Capacity	524
Checking.....	376
Preparing and checking before winter.....	252
"ENGINE START STOP" switch light	328
EPS	243

F	Floor mat 347	G	Gas station information 560
	Fluid		Gauges 197
	Washer..... 387		Gear Shift Indicator 192
	Fog lights		Glove box 332
	Replacing light bulbs..... 422	H	Hazard lights
	Switch 220		Switch 434
	Wattage..... 538		Head restraints
	Front fog lights		Adjusting 82
	Replacing light bulbs..... 422		Headlights
	Switch 220		Replacing light bulbs..... 422
	Wattage..... 538		Switch 214
	Front passenger's seat belt		Wattage 538
	reminder light 449		Heaters
	Front position lights		Seat heaters 343
	Replacing light bulbs..... 422		Side mirror 285
	Switch 214		Hill-start assist control 243
	Wattage..... 538		Hood 368
	Front seats		Horn 196
	Adjustment 76	I	Identification
	Front turn signal lights		Engine..... 519
	Replacing light bulbs..... 422		Vehicle 519
	Switch 194		Ignition switch 165, 169
	Wattage..... 538		Illuminated entry system 328
	Fuel		Indicator lights 201
	Capacity 523		Inside rear view mirror 92
	Fuel gauge 197		Intercooler 384
	Fuel pump shut off system..... 443		Interior light
	Gas station information 560		Interior light..... 328
	If you run out of fuel and		Switch 328
	the engine stalls..... 509		Wattage 538
	Information 539	J	Jack
	Refueling..... 100		Positioning a floor jack..... 370
	Type 523		Vehicle-equipped
	Fuel door 100		jack 459
	Fuel filler door 100		Jack handle 459
	Fuel filter 389		
	Fuel pump shut off system 443		
	Fuses 405		

- K** **Keyless entry** 44, 61
- Keys**
- Electronic key 40
 - Engine switch 165, 169
 - If the electronic key does not operate properly 494
 - If you lose your keys 493
 - Ignition switch 165, 169
 - Key number 40
 - Keyless entry 44, 61
 - Keys 40
 - Mechanical key 40
 - Wireless remote control key... 61
- L** **License plate lights**
- Replacing light bulbs 422
 - Wattage 538
- Light bulbs**
- Replacing 422
 - Wattage 538
- Lights**
- Emergency flasher switch 434
 - Fog light switch 220
 - Hazard light switch 434
 - Headlight switch 214
 - Interior light switch 329
 - Luggage compartment light 72
 - Personal light switch 329
 - Replacing light bulbs 422
 - Turn signal lever 194
 - Vanity lights 337
 - Wattage 538
- Lock steering column** 167, 175
- Luggage cover** 351
- M** **Maintenance**
- Do-it-yourself maintenance ... 365
 - Maintenance data 518
 - Maintenance requirements ... 362
- Manual air conditioning system** 268
- Manual headlight leveling dial** 215
- Manual transmission**
- Gear Shift Indicator 192
 - Manual transmission 190
- Meter**
- Instrument panel light control 212
 - Meters 197
- Mirrors**
- Inside rear view mirror 92
 - Side mirror heater 285
 - Side mirrors 94
 - Vanity mirrors 337
- MP3 disc** 301
- Multidrive**
- If the shift lever cannot be shifted from P 491
 - Multidrive 179
- Multi-information display** 208
- Multi-mode manual transmission**
- Easy (E) mode 187
 - Easy sports (Es) mode 186
 - If the shift lever cannot be shifted 492
 - Manual (M) mode 186
 - Multi-mode manual transmission 185
- O** **Odometer** 197
- Oil**
- Engine oil 376
- Opener**
- Back door 71
 - Fuel filler door 100
 - Hood 368

	Outside rear view mirrors			
	Adjusting and folding.....	94		
	Outside temperature display	339		
	Overheating, Engine	505		
P	Panoramic roof shade	346		
	Parking brake	195		
	Personal lights			
	Personal lights	328		
	Switch	329		
	Wattage.....	538		
	Portable ashtray	340		
	Power heater	283		
	Power outlet	342		
	Power windows	97		
R	Radiator	384		
	Radio	292		
	RDS (Radio Data System)	293		
	Rear fog light			
	Replacing light bulbs.....	422		
	Switch	220		
	Wattage.....	538		
	Rear seat			
	Adjustment	79		
	Folding down.....	79		
	Rear turn signal lights			
	Replacing light bulbs.....	422		
	Wattage.....	538		
	Rear view monitor system*			
	Rear window defogger	285		
	Rear window wiper	226		
	Replacing			
	Electronic key battery.....	401		
	Fuses	405		
	Key battery	401		
	Light bulbs.....	422		
	Tires	459		
	Wireless remote control battery	401		
S	Seat belts			
	Adjusting the seat belt	84		
	Child restraint system installation	134		
	Cleaning and maintaining the seat belts.....	360		
	Emergency Locking Retractor (ELR)	87		
	How to wear your seat belt	84		
	How your child should wear the seat belt.....	88		
	Pregnant women, proper seat belt use.....	87		
	Reminder light.....	449		
	Seat belt pretensioners.....	87		
	Seat heaters	343		
	Seats			
	Adjustment.....	76, 79		
	Adjustment precautions	78		
	Child seats/child restraint system installation	134		
	Cleaning.....	359		
	Head restraint	82		
	Properly sitting in the seat	109		
	Seat heaters	343		
	Service reminder indicators	201		
	Shift lever			
	If the shift lever cannot be shifted.....	492		
	If the shift lever cannot be shifted from P	491		
	Manual transmission	190		
	Multidrive	179		
	Multi-mode manual transmission	185		
	Shift lock system	491, 492		

Side airbags 111

Side mirrors
 Adjusting and folding..... 94

Side turn signal lights
 Replacing light bulbs..... 422
 Wattage..... 538

Smart entry & start system
 Antenna location 47
 Entry function 44
 Starting the engine..... 169

Spare tire
 Inflation pressure 533
 Storage location..... 459

Spark plug 529

Specifications 518

Speed limiter 232

Speedometer..... 197

Steering
 Column lock release 167, 175

Steering wheel
 Adjustment 91
 Audio switches 325

Stop & Start cancel switch..... 236

Stop & Start system..... 235

Stop & Start system
 operation time..... 210

Stop & Start system total
 operation time..... 211

Stop lights
 Replacing light bulbs..... 422
 Wattage..... 538

Storage feature 331

Storage precautions 250

Stuck
 If your vehicle becomes
 stuck 512

Sun visors 336

Sunshade
 Panoramic roof..... 346

Switch
 Airbag manual on-off
 switch 122
 Emergency flasher switch..... 434
 Engine switch..... 165, 169
 “Es” switch 186
 Fog light switch 220
 Hazard light switch..... 434
 Ignition switch 165, 169
 Light switches 214
 Power door lock switch 68
 Power window switch..... 97
 “SPORT” switch 180
 Stop & Start cancel switch 236
 Window lock switch..... 97
 Wiper and washer..... 222, 226

T **Tachometer** 197

Tail lights
 Replacing light bulbs..... 422
 Switch 214
 Wattage 538

Telephone switch*

Theft deterrent system
 Double locking system..... 107
 Engine immobilizer system ... 104

Tire inflation pressure 394

Tires
 Chains..... 252
 Checking..... 390
 If you have a flat tire 459, 471
 Inflation pressure 394, 533
 Replacing..... 459
 Rotating tires..... 390
 Size..... 533
 Snow tires 252
 Spare tire 459

Tools 459, 471

Total load capacity 518

*. Refer to “touch screen” Owner’s Manual”.

Towing
 Emergency towing 436
 Trailer towing 256
Traction control **243**
Transmission shift switches **186, 187**
TRC **243**
Trip information **208**
Trip meter **197**
Turn signal lights
 Replacing light bulbs 422
 Switch 194
 Wattage 538

V
Vanity lights
 Vanity lights 337
 Wattage 538
Vanity mirrors **337**
Vehicle identification number **519**
Vehicle stability control **243**
VSC **243**

W
Warning buzzers
 Brake system 444
 Clutch 445
 Electric power steering system 447
 Multi-mode manual transmission 445
 Seat belt reminder 449
Warning lights
 Anti-lock brake system 447
 Brake assist system 447
 Brake system 444
 Charging system 445
 Clutch 445
 Cruise control indicator light 447
 DPF system 447
 Electric power steering 447

Electronic engine control system 447
 Engine oil maintenance 449
 Fuel filter 447
 High engine coolant temperature 445
 Low engine oil level 449
 Low engine oil pressure 445
 Low fuel level 449
 Malfunction indicator lamp 447
 Multi-mode manual transmission 445
 Open door 449
 Pretensioners 447
 Seat belt reminder light 449
 Slip indicator light 447
 Smart entry & start system 447, 453
 Speed limiter system 232
 SRS airbags 447
 Stop & Start indicator light 447
Washer
 Checking 387
 Preparing and checking before winter 252
 Switch 222, 226
Washing and waxing **354**
Weight **518**
Wheels **396**
Window glasses **97**
Window lock switch **97**
Windows
 Power windows 97
 Rear window defogger 285
 Washer 222, 226
Windshield wiper **222, 226**
Wireless remote control key
 Locking/Unlocking 61
 Replacing the battery 401
 Wireless remote control 61
WMA disc **301**

What to do if... What to do if...

A tire punctures	P. 459 P. 471	If you have a flat tire
The engine does not start	P. 488	If the engine will not start
	P. 509	If you run out of fuel and the engine stalls
	P. 104	Engine immobilizer system
	P. 498	If the vehicle battery is discharged
The shift lever cannot be moved out	P. 494	If the electronic key does not operate properly
	P. 491	If the shift lever cannot be shifted from P
	P. 492	If the shift lever cannot be shifted
The high engine coolant temperature warning light flashes or comes on	P. 505	If your vehicle overheats
Steam can be seen coming from under the hood		
The key is lost	P. 493	If you lose your keys
The battery runs out	P. 498	If the vehicle battery is discharged
The doors cannot be locked	P. 67	Side doors
	P. 71	Back door
	P. 494	If the electronic key does not operate properly
	P. 44	Smart entry & start system
The vehicle is stuck in mud or sand	P. 512	If the vehicle becomes stuck

What to do if...

A warning light or indicator light comes on

P. 444

If a warning light turns on or a warning buzzer sounds...

■ Instrument cluster

Vehicles without a tachometer (type A)

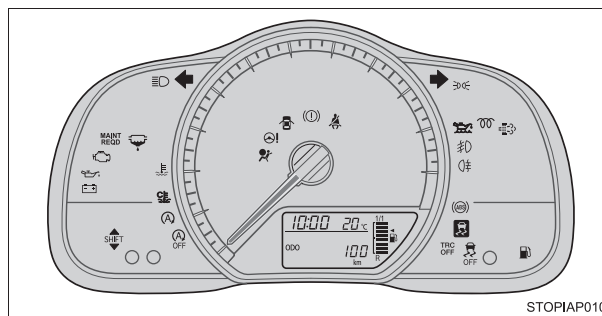

Vehicles without a tachometer (type B)

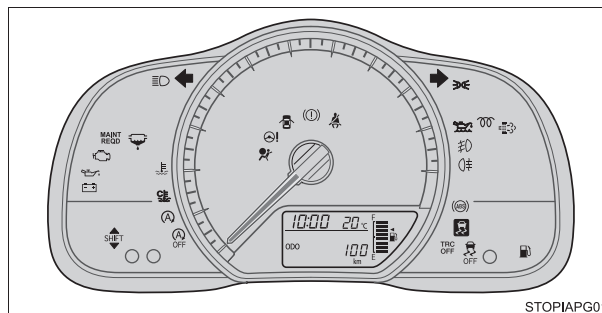

Vehicles with a tachometer (type A)

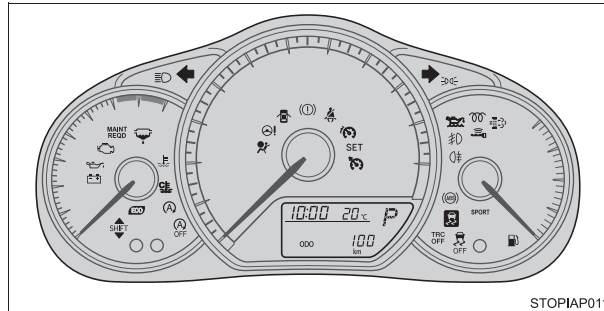

Vehicles with a tachometer (type B)

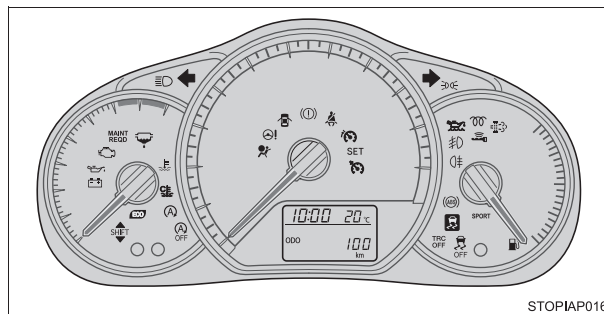

What to do if...

■ Center panel



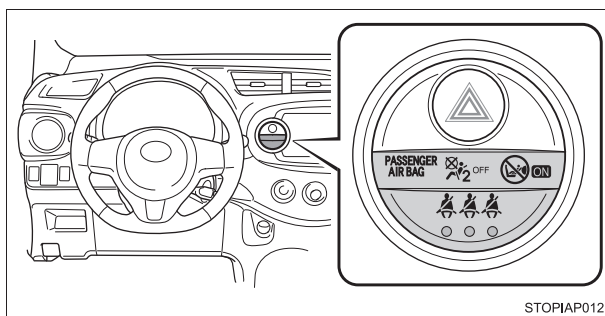

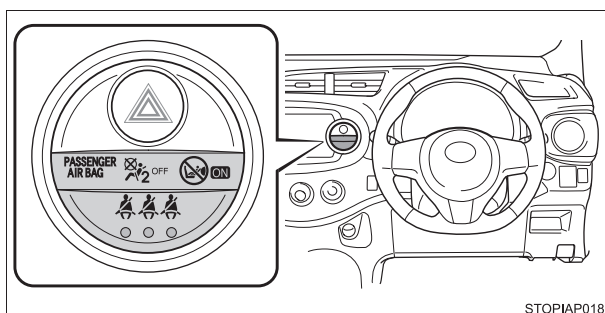

Left-hand drive vehicles



Right-hand drive vehicles



■ Warning lights

	Brake system warning light P. 444		Stop & Start cancel indicator light P. 448
	Charging system warning light P. 445		Fuel filter warning light P. 448
	Low engine oil pressure warning light P. 445		Smart entry & start system indicator light P. 448, 453
	High engine coolant temperature warning light P. 445		Open door warning light P. 449
	Multi-mode manual transmission warning light P. 445		Low fuel level warning light P. 449
	Malfunction indicator lamp P. 447		Driver's and front passenger's seat belt reminder light P. 449
	SRS warning light P. 447		Rear passengers' seat belt reminder lights P. 449
	ABS warning light P. 447		Low engine oil level warning light P. 449
	Electric power steering warning light P. 447		DPF system warning light P. 450
	Slip indicator light P. 447		Engine oil change reminder light P. 451
	Cruise control indicator light* P. 447	*: The light flashes to indicate a malfunction.	

GAS STATION INFORMATION

Auxiliary catch lever
P. 368

Fuel filler door
P. 100

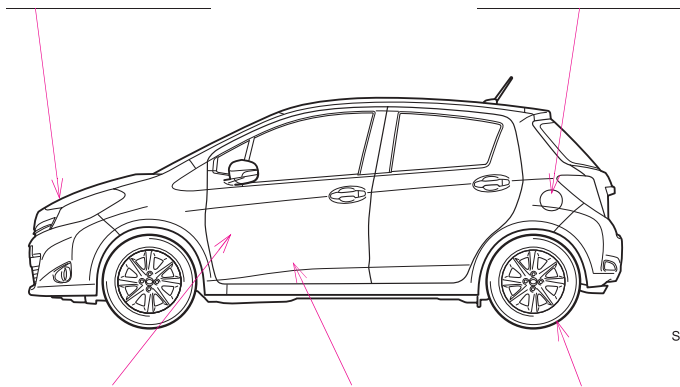

STOPIAP013

Hood lock release lever
P. 368

Fuel filler door opener
P. 100

Tire inflation pressure
P. 533

Fuel tank capacity (Reference)	42 L (11.1 gal., 9.2 Imp. gal.)
Fuel type	P. 523
Cold tire inflation pressure	P. 533
Engine oil capacity (Drain and refill — reference)	P. 524
Engine oil type	P. 525