

	Pictorial Index	Search by illustration
1	For safety and security	Make sure to read through them
2	Instrument cluster	How to read the gauges and meters, the variety of warning lights and indicators, etc.
3	Operation of each component	Opening and closing the doors and windows, adjustment before driving, etc.
4	Driving	Operations and advices which are necessary for driving
5	Audio system	Operating the audio system
6	Interior features	Usage of the interior features, etc.
7	Maintenance and care	Caring for your vehicle and maintenance procedures
8	When trouble arises	What to do in case of malfunction or emergency
9	Vehicle specifications	Vehicle specifications, customizable features, etc.
	Index	Search by symptom
		Search alphabetically

For your information	6
Reading this manual.....	8
How to search	9
Pictorial index.....	10

1 For safety and security

1-1. For safe use	
Before driving.....	26
For safety drive	28
Seat belts.....	30
SRS airbags.....	37
Airbag manual on-off system	49
Safety information for children	52
Child restraint systems	53
Installing child restraints	63
Exhaust gas precautions	73
1-2. Theft deterrent system	
Engine immobilizer system ..	74
Double locking system.....	79

2 Instrument cluster

2. Instrument cluster	
Warning lights and indica-	
tors.....	82
Gauges and meters	88
Multi-information display	90
Fuel consumption informa-	
tion.....	96

3 Operation of each component

3-1. Key information	
Keys	102
3-2. Opening, closing and locking the doors	
Side doors	114
Back door	121
Smart entry & start system	127
3-3. Adjusting the seats	
Front seats	138
Rear seats.....	141
Head restraints.....	144
3-4. Adjusting the steering wheel and mirrors	
Steering wheel	146
Inside rear view mirror.....	148
Outside rear view mirrors ..	151
3-5. Opening and closing the windows	
Power windows	154

4 Driving

4-1. Before driving

- Driving the vehicle 160
- Cargo and luggage 171
- Trailer towing 173

4-2. Driving procedures

- Engine (ignition) switch (vehicles without a smart entry & start system) 182
- Engine (ignition) switch (vehicles with a smart entry & start system) 185
- Multidrive 191
- Manual transmission 196
- Turn signal lever 200
- Parking brake 201

4-3. Operating the lights and wipers

- Headlight switch 202
- Fog light switch 208
- Windshield wiper and washer 210
- Rear window wiper and washer 214

4-4. Refueling

- Opening the fuel tank cap.. 216

4-5. Using the driving support systems

- Cruise control 220
- Speed limiter 224
- Stop & start system 228
- Driving assist systems 235
- Diesel particulate filter system 240

4-6. Driving tips

- Winter driving tips 242

5 Audio system

5-1. Basic Operations

- Audio system types 246
- Steering wheel audio switches 248
- USB port 249

5-2. Using the audio system

- Optimal use of the audio system 250

5-3. Using the radio

- Radio operation 252

5-4. Playing audio CDs and MP3/WMA discs

- CD player operation 257

5-5. Using an external device

- Listening to an iPod 266
- Listening to a USB memory device 273

6 Interior features

- 6-1. Using the air conditioning system and defogger**
 Manual air conditioning system..... 280
 Automatic air conditioning system.....287
 Power heater295
 Seat heaters297
- 6-2. Using the interior lights**
 Interior lights list.....299
 • Interior light.....299
 • Personal lights300
- 6-3. Using the storage features**
 List of storage features301
 • Glove box302
 • Cup holders303
 • Bottle holders304
 • Auxiliary box305
 Luggage compartment features.....306
- 6-4. Other interior features**
 Other interior features.....309
 • Sun visors.....309
 • Vanity mirrors309
 • Portable ashtray310
 • Cigarette lighter311
 • Power outlet312
 • Armrest.....313
 • Panoramic roof shade ...313
 • Assist grips314

7 Maintenance and care

- 7-1. Maintenance and care**
 Cleaning and protecting the vehicle exterior..... 316
 Cleaning and protecting the vehicle interior..... 319
- 7-2. Maintenance**
 Maintenance requirements.322
- 7-3. Do-it-yourself maintenance**
 Do-it-yourself service precautions 325
 Hood..... 328
 Positioning a floor jack 330
 Engine compartment..... 332
 Tires 347
 Tire inflation pressure..... 360
 Wheels 362
 Air conditioning filter..... 365
 Wireless remote control/electronic key battery..... 367
 Checking and replacing fuses..... 370
 Light bulbs..... 376

8 When trouble arises

8-1. Essential information

- Emergency flashers394
- If your vehicle has to be stopped in an emergency395

8-2. Steps to take in an emergency

- If your vehicle needs to be towed397
- If you think something is wrong.....403
- Fuel pump shut off system (gasoline engine only)404
- If a warning light turns on or a warning buzzer sounds....405
- If you have a flat tire (vehicles with a spare tire)418
- If you have a flat tire (vehicles with an emergency tire puncture repair kit)433
- If the engine will not start ...448
- If the shift lever cannot be shifted from P (vehicles with a Multidrive)450
- If the electronic key does not operate properly (vehicles with a smart entry & start system).....451
- If the vehicle battery is discharged.....453
- If your vehicle overheats458

- If you run out of fuel and the engine stalls (diesel engine only) 462
- If the vehicle becomes stuck.....464

9 Vehicle specifications

9-1. Specifications

- Maintenance data (fuel, oil level, etc.) 468
- Fuel information 487

9-2. Customization

- Customizable features 489

9-3. Items to initialize

- Items to initialize..... 493

Index

- What to do if... (Troubleshooting)..... 496
- Alphabetical index..... 500

For your information

Main Owner's Manual

Please note that this manual applies to all models and explains all equipment, including options. Therefore, you may find some explanations for equipment not installed on your vehicle.

All specifications provided in this manual are current at the time of printing. However, because of the Toyota policy of continual product improvement, we reserve the right to make changes at any time without notice.

Depending on specifications, the vehicle shown in the illustrations may differ from your vehicle in terms of equipment.

Accessories, spare parts and modification of your Toyota

Both genuine Toyota and a wide variety of other spare parts and accessories for Toyota vehicles are currently available in the market. Should it be determined that any of the genuine Toyota parts or accessories supplied with the vehicle need to be replaced, Toyota recommends that genuine Toyota parts or accessories, be used to replace them. Other parts or accessories of matching quality can also be used. Toyota cannot accept any liability or guarantee spare parts and accessories which are not genuine Toyota products, nor for replacement or installation involving such parts. In addition, damage or performance problems resulting from the use of non-genuine Toyota spare parts or accessories may not be covered under warranty.

Installation of an RF-transmitter system

The installation of an RF-transmitter system in your vehicle could affect electronic systems such as:

- Multiport fuel injection system/sequential multiport fuel injection system
- Cruise control system (if equipped)
- Anti-lock brake system
- SRS airbag system
- Seat belt pretensioner system

Be sure to check with any authorized Toyota dealer or repairer, or another duly qualified and equipped professional for precautionary measures or special instructions regarding installation of an RF-transmitter system.

Further information regarding frequency bands, power levels, antenna positions and installation provisions for the installation of RF-transmitters, is available on request at any authorized Toyota dealer or repairer, or another duly qualified and equipped professional.

Scraping of your Toyota

The SRS airbag and seat belt pretensioner devices in your Toyota contain explosive chemicals. If the vehicle is scrapped with the airbags and seat belt pretensioners left as they are, this may cause an accident such as fire. Be sure to have the systems of the SRS airbag and seat belt pretensioner removed and disposed of by a qualified service shop or by any authorized Toyota dealer or repairer, or another duly qualified and equipped professional, before you scrap your vehicle.



Your vehicle contains batteries and/or accumulators. Do not discard them into the environment but cooperate with separate collection (Directive 2006/66/EC).

WARNING

■ General precautions while driving

Driving under the influence: Never drive your vehicle when under the influence of alcohol or drugs that have impaired your ability to operate your vehicle. Alcohol and certain drugs delay reaction time, impair judgment and reduce coordination, which could lead to an accident that could result in death or serious injury.

Defensive driving: Always drive defensively. Anticipate mistakes that other drivers or pedestrians might make and be ready to avoid accidents.

Driver distraction: Always give your full attention to driving. Anything that distracts the driver, such as adjusting controls, talking on a cellular phone or reading can result in a collision with resulting death or serious injury to you, your occupants or others.

■ General precaution regarding children's safety

Never leave children unattended in the vehicle, and never allow children to have or use the key.

Children may be able to start the vehicle or shift the vehicle into neutral. There is also a danger that children may injure themselves by playing with the cigarette lighter, the windows, the panoramic roof shade, or other features of the vehicle. In addition, heat build-up or extremely cold temperatures inside the vehicle can be fatal to children.

Reading this manual



WARNING:

Explains something that, if not obeyed, could cause death or serious injury to people.



NOTICE:

Explains something that, if not obeyed, could cause damage to or a malfunction in the vehicle or its equipment.



1 2 3 ... Indicates operating or working procedures. Follow the steps in numerical order.



Indicates the action (pushing, turning, etc.) used to operate switches and other devices.



Indicates the outcome of an operation (e.g. a lid opens).

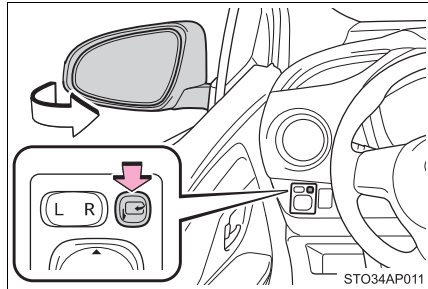

Indicates the component or position being explained.



Means "Do not", "Do not do this", or "Do not let this happen".

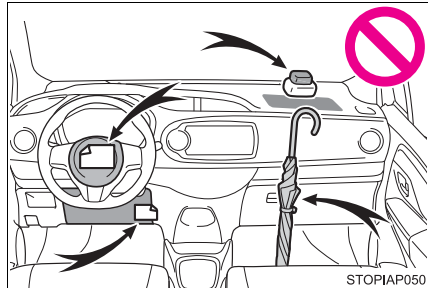

How to search

■ Searching by name

- Alphabetical index P. 500

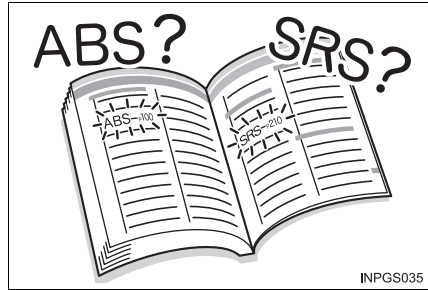

■ Searching by installation position

- Pictorial index P. 10



■ Searching by symptom or sound

- What to do if...
(Troubleshooting) P. 496



■ Searching by title

- Table of contents P. 2

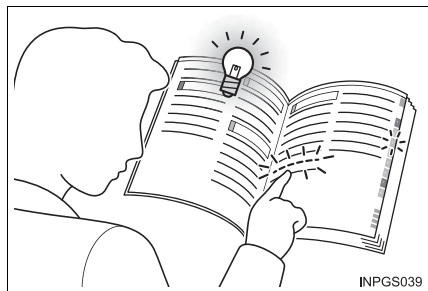

Pictorial index

■ Exterior

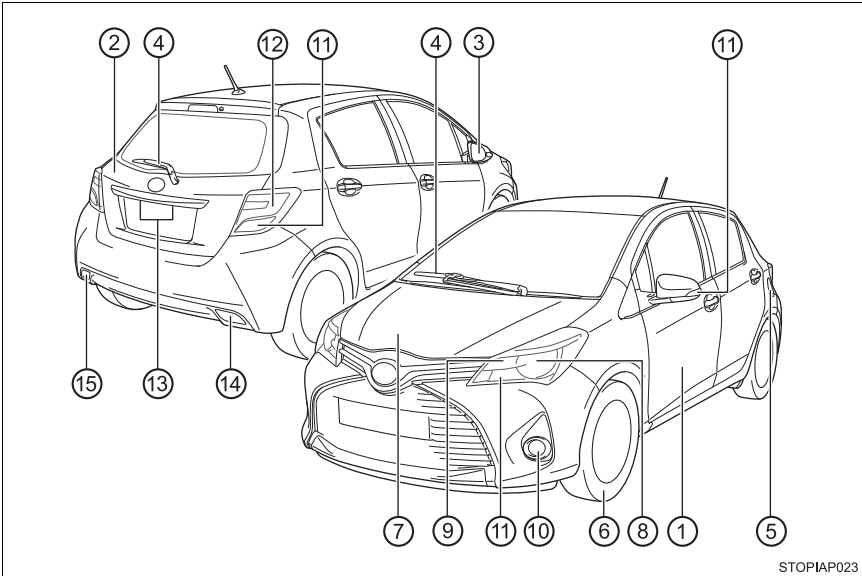

The illustration represents the 5-door models and may differ from the body shape of the 3-door models.

- | | | |
|---|---|---------------|
| ① | Side doors | P. 114 |
| | Locking/unlocking | P. 114 |
| | Opening/closing the side windows | P. 154 |
| | Locking/unlocking by using the mechanical key* ¹ | P. 451 |
| | Warning lights | P. 407 |
| ② | Back door | P. 121 |
| | Locking/unlocking | P. 121 |
| | Warning lights | P. 407 |
| ③ | Outside rear view mirrors | P. 151 |
| | Adjusting the mirror angle | P. 151 |
| | Folding the mirrors | P. 152 |
| | Defogging the mirrors* ² | P. 283, 291 |

- ④ **Wipers** **P. 210, 214**
 - Precautions against winter season P. 242
 - Precautions against car wash P. 317
- ⑤ **Fuel filler door** **P. 216**
 - Refueling method P. 216
 - Fuel type/fuel tank capacity P. 473
- ⑥ **Tires** **P. 347**
 - Tire size/inflation pressure P. 483
 - Winter tires/tire chain P. 243
 - Checking/rotation P. 347
 - Coping with flat tires P. 418
- ⑦ **Hood** **P. 328**
 - Opening P. 328
 - Engine oil P. 474
 - Coping with overheat P. 458

Light bulbs of the exterior lights for driving

(Replacing method: P. 376, Watts: P. 486)

- ⑧ **Halogen headlights** **P. 202**
- ⑨ **Front position lights/daytime running lights** **P. 202**
- ⑩ **Front fog lights*²** **P. 208**
- ⑪ **Turn signal lights** **P. 200**
- ⑫ **Stop/tail lights** **P. 202**
- ⑬ **License plate lights** **P. 202**
- ⑭ **Rear fog light** **P. 208**
 - Back-up light**
 - Shifting the shift lever to R. P. 191, 196
- ⑮ **Rear fog light** **P. 208**
 - Back-up light**
 - Shifting the shift lever to R. P. 191, 196

*1: Vehicles with a smart entry & start system
*2: If equipped

■ Instrument panel (Left-hand drive vehicles)

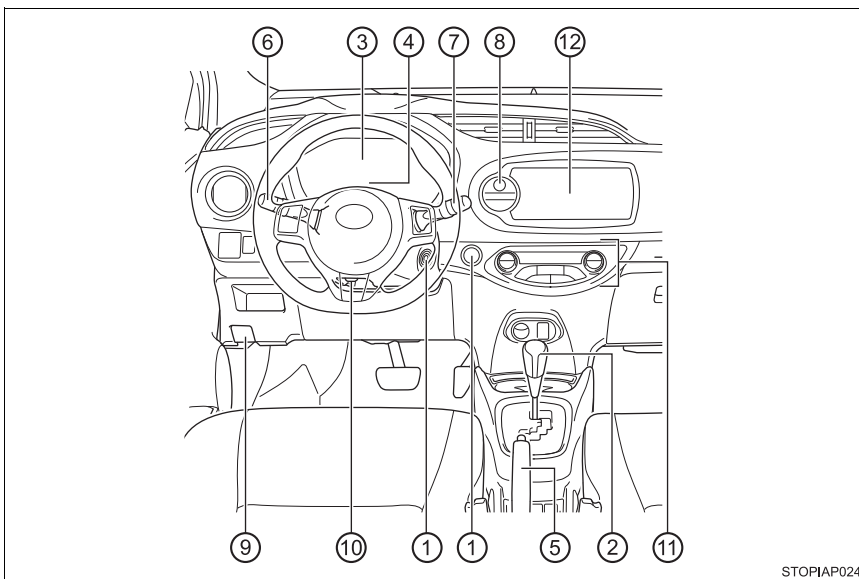

STOPIAP024

- ① **Engine switch** **P. 182, 185**
 Starting the engine. P. 182, 185
 Changing engine switch positions/modes P. 183, 186
 Emergency stop of the engine. P. 395
 When the engine will not start P. 448
 Warning lights^{*1} P. 415
- ② **Shift lever** **P. 191, 196**
 Changing the shift position P. 191, 196
 Precautions against towing P. 397
 When the shift lever does not move^{*2}. P. 450
- ③ **Meters** **P. 88**
 Reading the meters P. 88
 Warning lights/indicator lights P. 82
 When the warning lights come on P. 405

- ④ **Multi-information display** **P. 90**
- ⑤ **Parking brake** **P. 201**
 - Applying/releasing P. 201
 - Precautions against winter season P. 243
 - Warning buzzer P. 405
- ⑥ **Turn signal lever** **P. 200**
 - Headlight switch** **P. 202**
 - Headlights/front position lights/tail lights P. 202
 - Front fog lights^{*3}/rear fog light P. 208
- ⑦ **Wiper and washer switch** **P. 210, 214**
 - Usage (front) P. 210
 - Usage (rear) P. 214
 - Adding washer fluid P. 345
- ⑧ **Emergency flasher switch** **P. 394**
- ⑨ **Hood lock release lever** **P. 328**
- ⑩ **Tilt and telescopic steering lock release lever** **P. 146**
- ⑪ **Air conditioning system** **P. 280, 287**
 - Usage (manual air conditioning system) P. 280
 - Usage (automatic air conditioning system) P. 287
 - Rear window defogger P. 283, 291
- ⑫ **Audio system^{*3}** **P. 246**
Navigation/Multimedia system^{*3, 4}

*1: Vehicles with a smart entry & start system

*2: Except manual transmission

*3: If equipped

*4: Refer to "Navigation and multimedia system Owner's manual".

■ Switches (Left-hand drive vehicles)

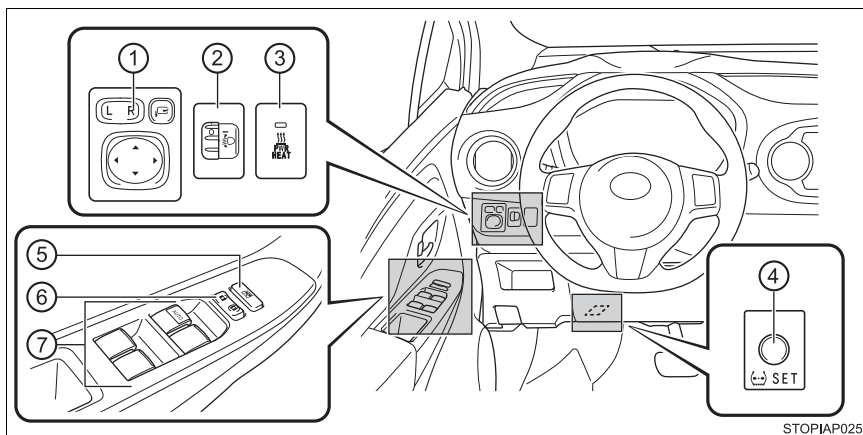

①	Outside rear view mirror switches	P. 151
②	Manual headlight leveling dial	P. 204
③	Power heater switch *1	P. 295
④	Tire pressure warning reset switch *1	P. 349
⑤	Window lock switch	P. 154
⑥	Door lock switch	P. 118
⑦	Power window switches	P. 154

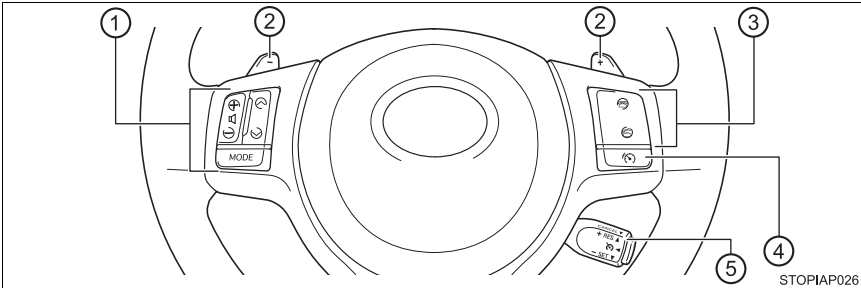

- ① Audio remote control switches*1 P. 248
- ② Paddle shift switches*1 P. 193
- ③ Telephone switch *2
- ④ Speed limiter switch*1 P. 224
- ⑤ Cruise control switch*1 P. 220

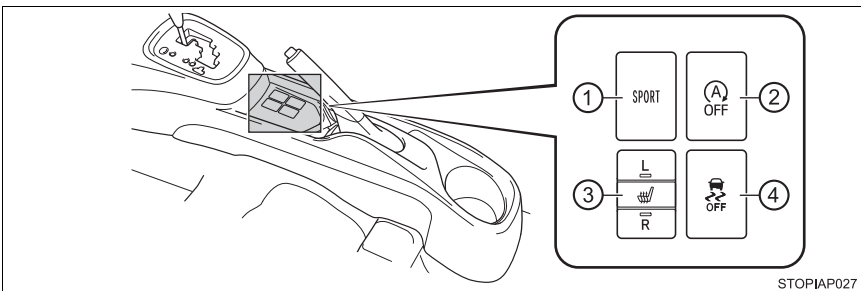

- ① "SPORT" switch*1 P. 192
- ② Stop & Start cancel switch*1 P. 229
- ③ Seat heater switch*1 P. 297
- ④ VSC OFF switch*1 P. 236

*1: If equipped

*2: Refer to "Navigation and multimedia system Owner's manual".

■ Interior (Left-hand drive vehicles)

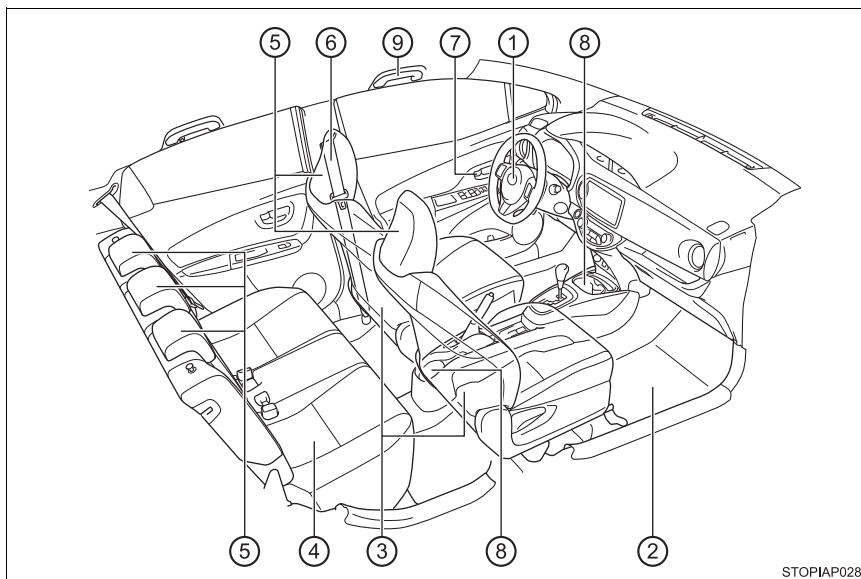

- | | | |
|---|----------------------------------|---------------|
| ① | SRS airbags | P. 37 |
| ② | Floor mats | P. 26 |
| ③ | Front seats | P. 138 |
| ④ | Rear seats *2 | P. 141 |
| ⑤ | Head restraints | P. 144 |
| ⑥ | Seat belts | P. 30 |
| ⑦ | Inside lock buttons | P. 118 |
| ⑧ | Cup holders | P. 303 |
| ⑨ | Assist grips | P. 314 |

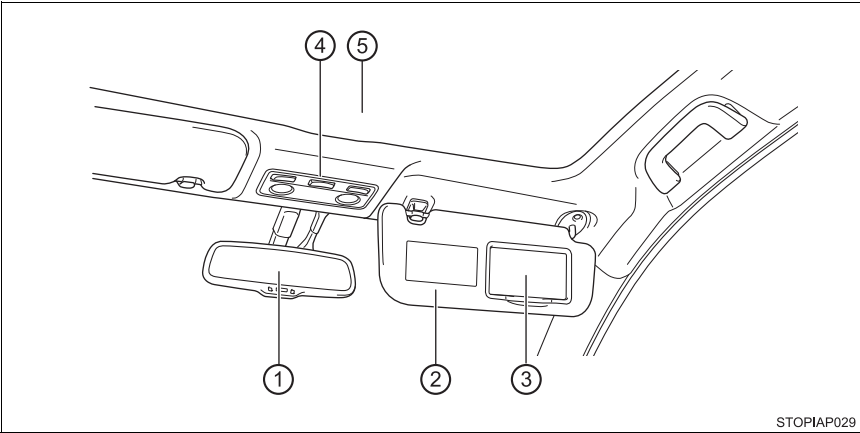

STOPIAP029

- ① Inside rear view mirror P. 148
- ② Sun visors*1 P. 309
- ③ Vanity mirrors P. 309
- ④ Interior light/personal lights P. 299
- ⑤ Panoramic roof shade*2 P. 313

*1: NEVER use a rearward facing child restraint on a seat protected by an ACTIVE AIRBAG in front of it, DEATH or SERIOUS INJURY to the CHILD can occur. (→P. 70)

*2: If equipped



■ Instrument panel (Right-hand drive vehicles)

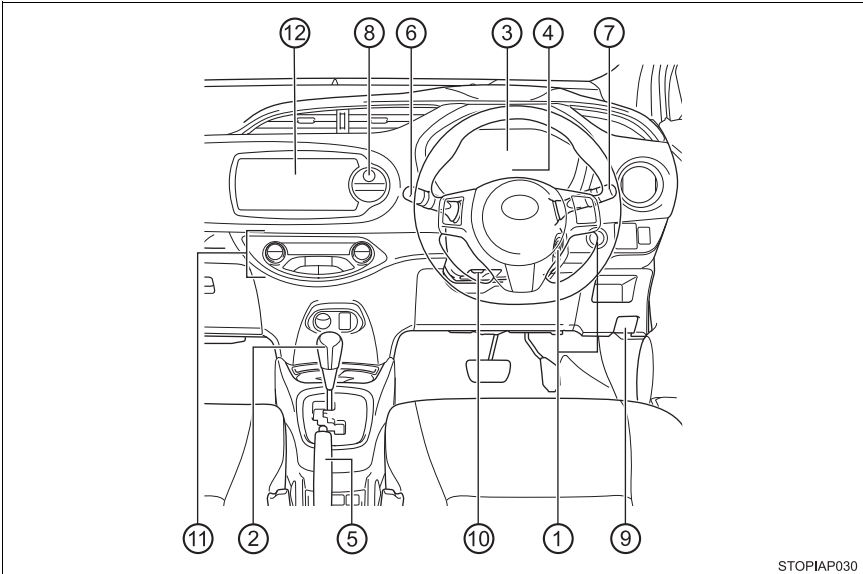

STOPIAP030

- ① **Engine switch** **P. 182, 185**
 Starting the engine. P. 182, 185
 Changing engine switch positions/modes P. 183, 186
 Emergency stop of the engine. P. 395
 When the engine will not start P. 448
 Warning lights*¹ P. 415
- ② **Shift lever** **P. 191, 196**
 Changing the shift position P. 191, 196
 Precautions against towing P. 397
 When the shift lever does not move*². P. 450
- ③ **Meters** **P. 88**
 Reading the meters P. 88
 Warning lights/indicator lights P. 82
 When the warning lights come on P. 405

- ④ **Multi-information display** **P. 90**
- ⑤ **Parking brake** **P. 201**
 - Applying/releasing P. 201
 - Precautions against winter season P. 243
 - Warning buzzer P. 405
- ⑥ **Turn signal lever** **P. 200**
 - Headlight switch** **P. 202**
 - Headlights/front position lights/tail lights P. 202
 - Front fog lights^{*3}/rear fog light P. 208
- ⑦ **Wiper and washer switch** **P. 210, 214**
 - Usage (front) P. 210
 - Usage (rear) P. 214
 - Adding washer fluid P. 345
- ⑧ **Emergency flasher switch** **P. 394**
- ⑨ **Hood lock release lever** **P. 328**
- ⑩ **Tilt and telescopic steering lock release lever** **P. 146**
- ⑪ **Air conditioning system** **P. 280, 287**
 - Usage (manual air conditioning system) P. 280
 - Usage (automatic air conditioning system) P. 287
 - Rear window defogger P. 283, 291
- ⑫ **Audio system^{*3}** **P. 246**
 - Navigation/Multimedia system^{*3, 4}**

*1: Vehicles with a smart entry & start system

*2: Except manual transmission

*3: If equipped

*4: Refer to "Navigation and multimedia system Owner's manual".

■ Switches (Right-hand drive vehicles)

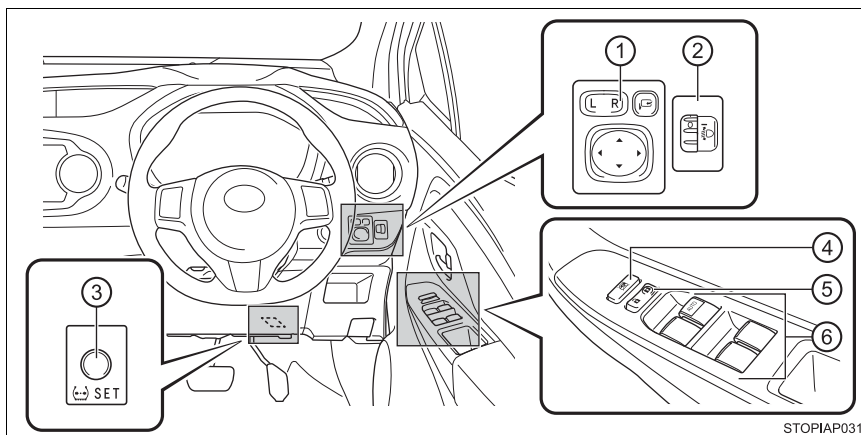

- ① Outside rear view mirror switches*1 P. 151
- ② Manual headlight leveling dial P. 204
- ③ Tire pressure warning reset switch*1 P. 349
- ④ Window lock switch P. 154
- ⑤ Door lock switch P. 118
- ⑥ Power window switches P. 154

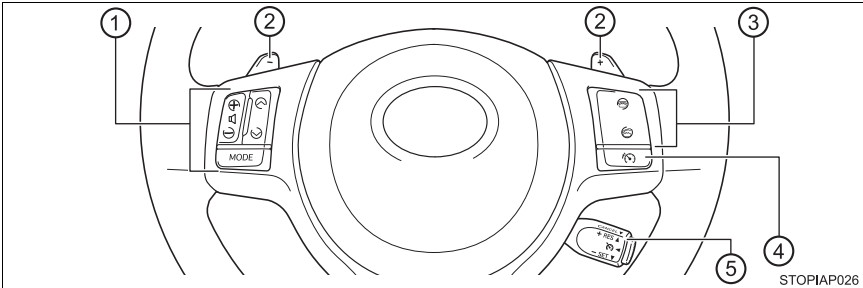

- ① Audio remote control switches*1 P. 248
- ② Paddle shift switches*1 P. 193
- ③ Telephone switch *2
- ④ Speed limiter switch*1 P. 224
- ⑤ Cruise control switch*1 P. 220

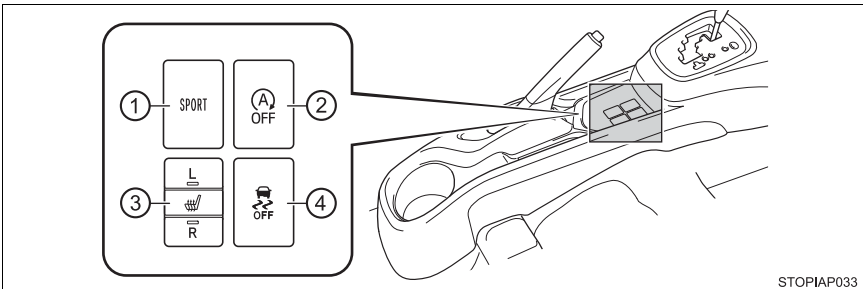

- ① “SPORT” switch*1 P. 192
- ② Stop & Start cancel switch*1 P. 229
- ③ Seat heater switch*1 P. 297
- ④ VSC OFF switch*1 P. 236

*1: If equipped

*2: Refer to “Navigation and multimedia system Owner’s manual”.

■ Interior (Right-hand drive vehicles)

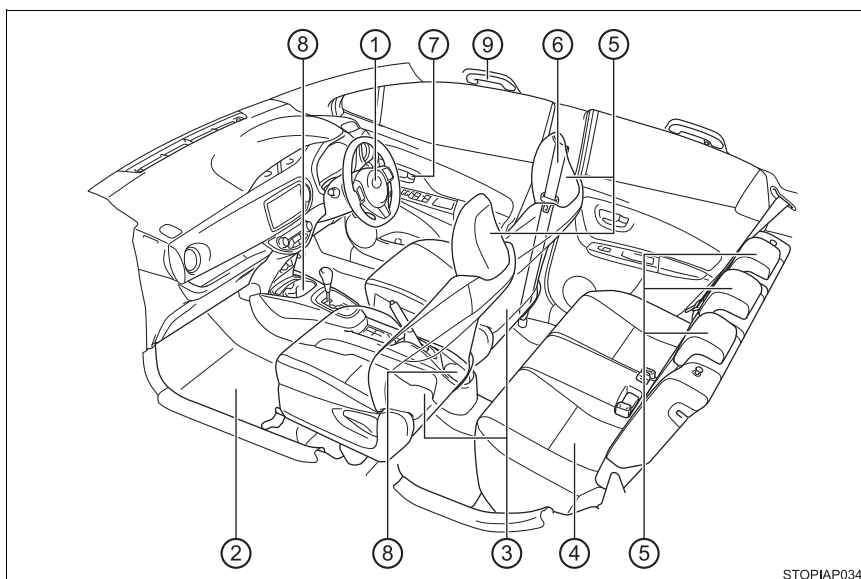

STOPIAP034

- | | | |
|---|----------------------------------|---------------|
| ① | SRS airbags | P. 37 |
| ② | Floor mats | P. 26 |
| ③ | Front seats | P. 138 |
| ④ | Rear seats *2 | P. 141 |
| ⑤ | Head restraints | P. 144 |
| ⑥ | Seat belts | P. 30 |
| ⑦ | Inside lock buttons | P. 118 |
| ⑧ | Cup holders | P. 303 |
| ⑨ | Assist grips | P. 314 |

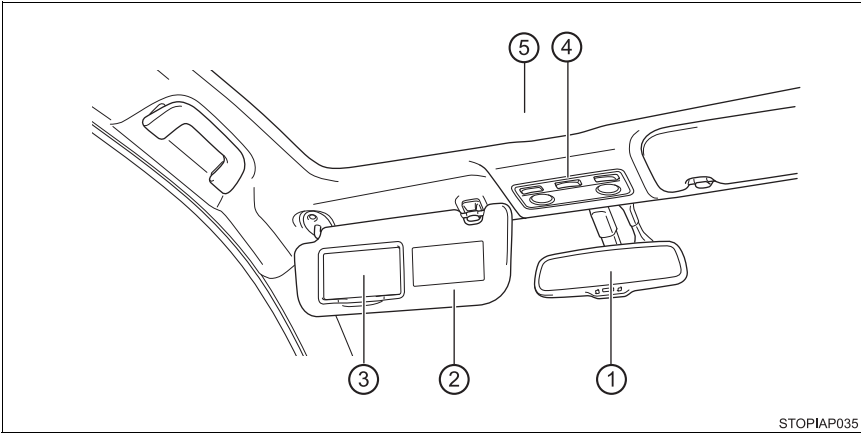

STOPIAP035

- ① **Inside rear view mirror** P. 148
- ② **Sun visors*1** P. 309
- ③ **Vanity mirrors** P. 309
- ④ **Interior light/personal lights** P. 299
- ⑤ **Panoramic roof shade*2** P. 313

*1: NEVER use a rearward facing child restraint on a seat protected by an ACTIVE AIRBAG in front of it, DEATH or SERIOUS INJURY to the CHILD can occur. (→P. 70)

*2: If equipped



For safety and security

1

1-1. For safe use	
Before driving.....	26
For safety drive	28
Seat belts.....	30
SRS airbags.....	37
Airbag manual on-off system	49
Safety information for children.....	52
Child restraint systems	53
Installing child restraints	63
Exhaust gas precautions	73
1-2. Theft deterrent system	
Engine immobilizer system	74
Double locking system.....	79

Before driving

Floor mat

Use only floor mats designed specifically for vehicles of the same model and model year as your vehicle. Fix them securely in place onto the carpet.

- 1 Insert the retaining hooks (clips) into the floor mat eyelets.

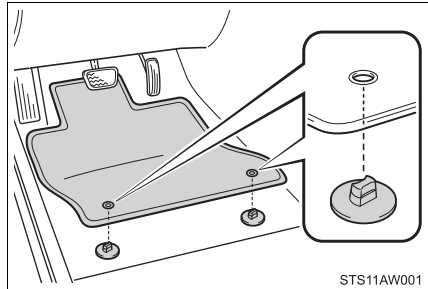

- 2 Turn the upper knob of each retaining hook (clip) to secure the floor mats in place.

*: Always align the \triangle marks.

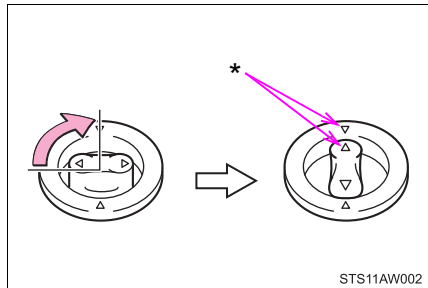

The shape of the retaining hooks (clips) may differ from that shown in the illustration.

⚠ WARNING

Observe the following precautions.

Failure to do so may cause the driver's floor mat to slip, possibly interfering with the pedals while driving. An unexpectedly high speed may result or it may become difficult to stop the vehicle, leading to an accident, or leading to death or a serious injury.

■ When installing the driver's floor mat

- Do not use floor mats designed for other models or different model year vehicles, even if they are Toyota Genuine floor mats.
- Only use floor mats designed for the driver's seat.
- Always install the floor mat securely using the retaining hooks (clips) provided.
- Do not use two or more floor mats on top of each other.
- Do not place the floor mat bottom-side up or upside-down.

■ Before driving

- Check that the floor mat is securely fixed in the correct place with all the provided retaining hooks (clips). Be especially careful to perform this check after cleaning the floor.
- With the engine stopped and the shift lever in P (Multidrive) or N (manual transmission), fully depress each pedal to the floor to make sure it does not interfere with the floor mat.

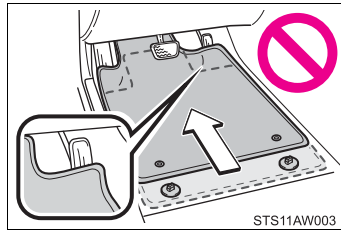

For safety drive

For safe driving, adjust the seat and mirror to an appropriate position before driving.

Correct driving posture

- ① Adjust the angle of the seat-back so that you are sitting straight up and so that you do not have to lean forward to steer. (→P. 138)
- ② Adjust the seat so that you can depress the pedals fully and so that your arms bend slightly at the elbow when gripping the steering wheel. (→P. 138, 146)

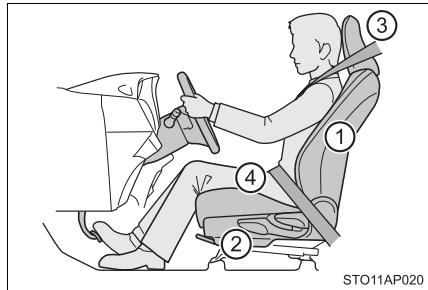

- ③ Lock the head restraint in place with the center of the head restraint closest to the top of your ears. (→P. 144)
- ④ Wear the seat belt correctly. (→P. 30)

Correct use of the seat belts

Make sure that all occupants are wearing their seat belts before driving the vehicle. (→P. 30)

Use a child restraint system appropriate for the child until the child becomes large enough to properly wear the vehicle's seat belt. (→P. 53)

Adjusting the mirrors

Make sure that you can see the rear of the vehicle clearly, by adjusting the inside and outside rear view mirrors properly. (→P. 148, 151)

WARNING

Observe the following precautions.

Failure to do so may result in death or serious injury.

- Do not adjust the position of the driver's seat while driving.
Doing so could cause the driver to lose control of the vehicle.
- Do not place a cushion between the driver or passenger and the seatback.
A cushion may prevent correct posture from being achieved, and reduce the effectiveness of the seat belt and head restraint.
- Do not place anything under the front seats.
Objects placed under the front seats may become jammed in the seat tracks and stop the seat from locking in place. This may lead to an accident and the adjustment mechanism may also be damaged.
- When driving over long distances, take regular breaks before you start to feel tired.
Also, if you feel tired or sleepy while driving, do not force yourself to continue driving and take a break immediately.

Seat belts

Make sure that all occupants are wearing their seat belts before driving the vehicle.

Correct use of the seat belts

- Extend the shoulder belt so that it comes fully over the shoulder, but does not come into contact with the neck or slide off the shoulder.
- Position the lap belt as low as possible over the hips.
- Adjust the position of the seat-back. Sit up straight and well back in the seat.
- Do not twist the seat belt.

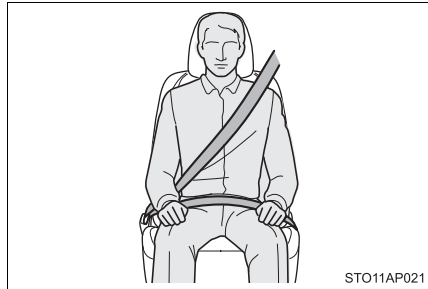

Fastening and releasing the seat belt

- ① To fasten the seat belt, push the plate into the buckle until a click sound is heard.
- ② To release the seat belt, press the release button.

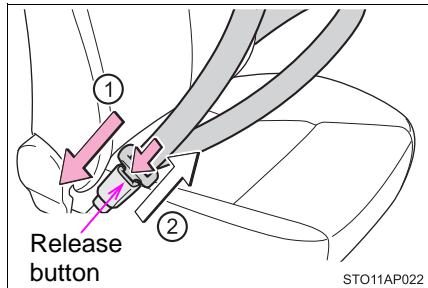

Fastening the rear center seat belt

- 1 Take out the plate, and then pull the seat belt.



- 2 Push the plate into the buckle in the order of plate "A" and plate "B" until a clicking sound is heard.

- ① Plate "A", buckle "A"
- ② Plate "B", buckle "B"

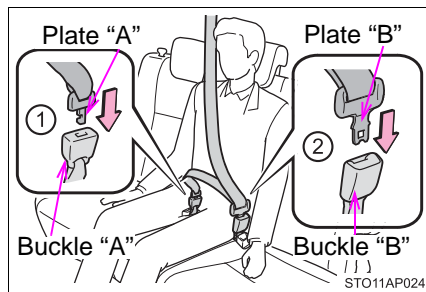

Releasing and stowing the rear center seat belt

- 1 To release the hooked plate "B", push the buckle release button.

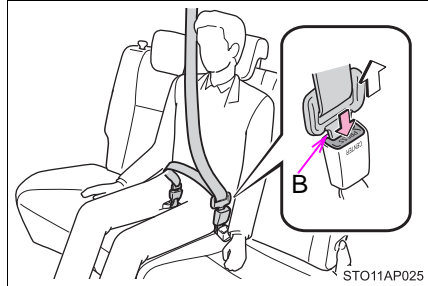

- 2 To release the hooked plate "A", insert the plate "B" or the key or the mechanical key (→P. 104) into the hole on the buckle.

When releasing the seat belt, retract it slowly.

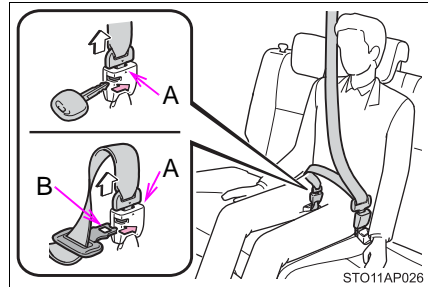

- 3 Stow the plates as shown in the illustration.

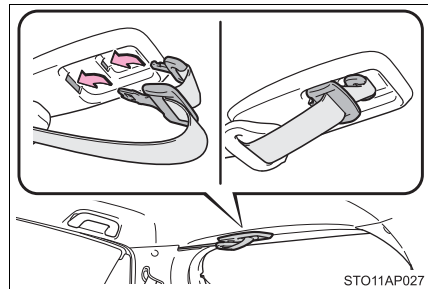

Seat belt pretensioners (front seat)

The pretensioners help the seat belts to quickly restrain the occupants by retracting the seat belts when the vehicle is subjected to certain types of severe frontal collision.

The pretensioners do not activate in the event of a minor frontal impact, a side impact, a rear impact or a vehicle rollover.

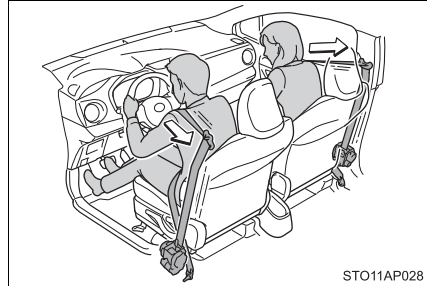

■ Emergency locking retractor (ELR)

The retractor will lock the belt during a sudden stop or on impact. It may also lock if you lean forward too quickly. A slow, easy motion will allow the belt to extend so that you can move around fully.

■ Child seat belt usage

The seat belts of your vehicle were principally designed for persons of adult size.

- Use a child restraint system appropriate for the child, until the child becomes large enough to properly wear the vehicle's seat belt. (→P. 53)
- When the child becomes large enough to properly wear the vehicle's seat belt, follow the instructions regarding seat belt usage. (→P. 30)

■ Having the belt replaced after the pretensioner has been activated

If the vehicle is involved in multiple collisions, the pretensioner will activate for the first collision, but will not activate for the second or subsequent collisions.

■ Seat belt regulations

If seat belt regulations exist in the country where you reside, please contact any authorized Toyota dealer or repairer, or another duly qualified and equipped professional for seat belt replacement or installation.

⚠ WARNING

Observe the following precautions to reduce the risk of injury in the event of sudden braking, sudden swerving or an accident.
Failure to do so may cause death or serious injury.

■ Wearing a seat belt

- Ensure that all passengers wear a seat belt.
- Always wear a seat belt properly.
- Each seat belt should be used by one person only. Do not use a seat belt for more than one person at once, including children.
- Toyota recommends that children be seated in the rear seat and always use a seat belt and/or an appropriate child restraint system.
- To achieve a proper seating position, do not recline the seat more than necessary. The seat belt is most effective when the occupants are sitting up straight and well back in the seats.
- Do not wear the shoulder belt under your arm.
- Always wear your seat belt low and snug across your hips.

■ Pregnant women

Obtain medical advice and wear the seat belt in the proper way. (→P. 30)

Women who are pregnant should position the lap belt as low as possible over the hips in the same manner as other occupants, extending the shoulder belt completely over the shoulder and avoiding belt contact with the rounding of the abdominal area.

If the seat belt is not worn properly, not only the pregnant woman, but also the fetus could suffer death or serious injury as a result of sudden braking or a collision.

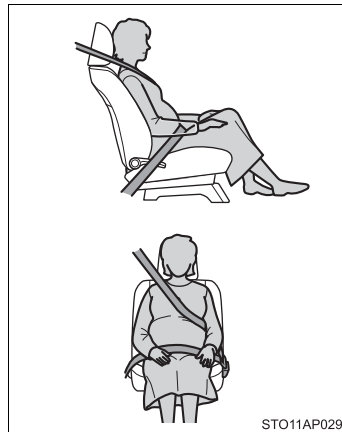

 **WARNING****■ People suffering illness**

Obtain medical advice and wear the seat belt in the proper way. (→P. 30)

■ When children are in the vehicle

- Do not allow children to play with the seat belt. If the seat belt becomes twisted around a child's neck, it may lead to choking or other serious injuries that could result in death.
If this occurs and the buckle cannot be unfastened, scissors should be used to cut the belt.

■ Seat belt pretensioners

- Do not place anything, such as a cushion, on the front passenger's seat. The seat belt pretensioner for the front passenger's seat may not activate in the event of a collision.
- If the pretensioner has activated, the SRS warning light will come on. In that case, the seat belt cannot be used again and must be replaced at any authorized Toyota dealer or repairer, or another duly qualified and equipped professional.

■ Seat belt damage and wear

- Do not damage the seat belts by allowing the belt, plate, or buckle to be jammed in the door.
- Inspect the seat belt system periodically. Check for cuts, fraying, and loose parts. Do not use a damaged seat belt until it is replaced. Damaged seat belts cannot protect an occupant from death or serious injury.
- Ensure that the belt and plate are locked and the belt is not twisted. If the seat belt does not function correctly, immediately contact any authorized Toyota dealer or repairer, or another duly qualified and equipped professional.
- Replace the seat assembly, including the belts, if your vehicle has been involved in a serious accident, even if there is no obvious damage.
- Do not attempt to install, remove, modify, disassemble or dispose of the seat belts. Have any necessary repairs carried out by any authorized Toyota dealer or repairer, or another duly qualified and equipped professional. Inappropriate handling may lead to incorrect operation.

⚠ WARNING**■ When using the rear center seat belt**

- Do not use the rear center seat belt with either buckle released.

Fastening only one of the buckles may result in death or serious injury in case of sudden braking or a collision.



- Do not allow anyone sit on the rear center seat if the rear right seat is folded down, as the seat belt buckle for the rear center seat belt is then concealed under the folded seat and cannot be used.

SRS airbags

The SRS airbags inflate when the vehicle is subjected to certain types of severe impacts that may cause significant injury to the occupants. They work together with the seat belts to help reduce the risk of death or serious injury.

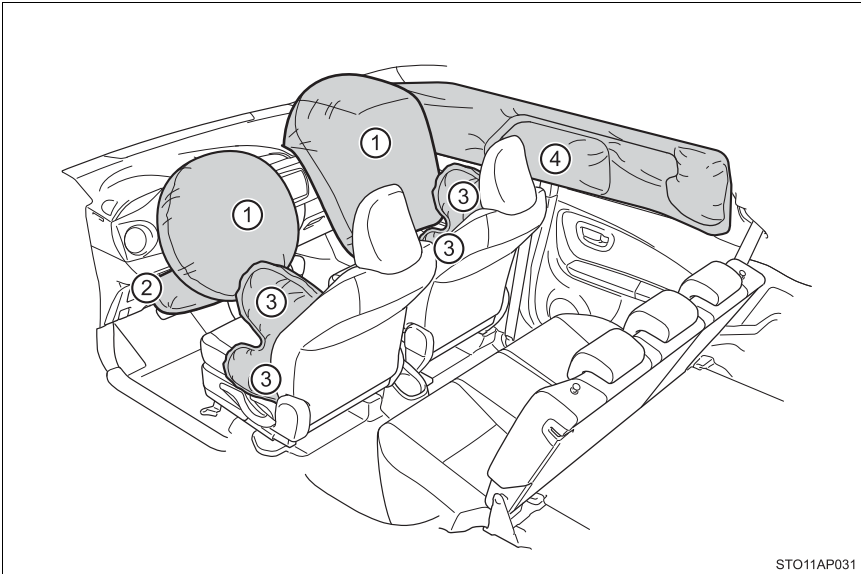

◆ SRS front airbags

- ① SRS driver airbag/front passenger airbag
Can help protect the head and chest of the driver and front passenger from impact with interior components
- ② SRS driver knee airbag (if equipped)
Can help provide driver protection

◆ SRS side and curtain shield airbags

- ③ SRS side airbags
Can help protect the torso of the front seat occupants
- ④ SRS curtain shield airbags (if equipped)
Can help protect primarily the head of occupants in the outer seats

SRS airbag system components

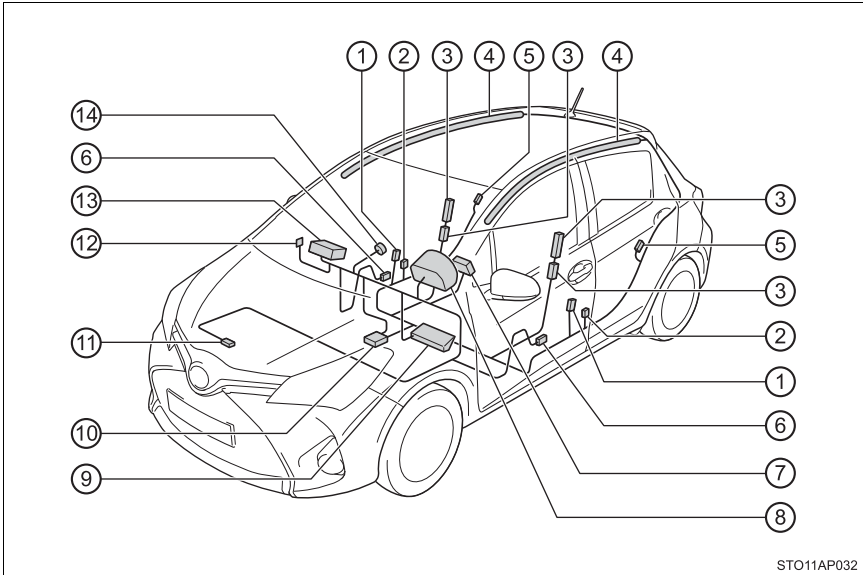

- | | |
|--|------------------------------------|
| ① Seat belt pretensioners and force limiters | ⑧ SRS warning light |
| ② Side impact sensors (front) ^{*1} | ⑨ Driver knee airbag ^{*3} |
| ③ Side airbags | ⑩ Airbag sensor assembly |
| ④ Curtain shield airbags ^{*3} | ⑪ Front impact sensor |
| ⑤ Side impact sensors (rear) ^{*3} | ⑫ Airbag manual on-off switch |
| ⑥ Side impact sensors (front door) ^{*2} | ⑬ Front passenger airbag |
| ⑦ Driver airbag | ⑭ "PASSENGER AIR BAG" indicator |

*1: 5-door models

*2: 3-door models

*3: If equipped

The main SRS airbag system components are shown above. The SRS airbag system is controlled by the airbag sensor assembly. As the airbags deploy, a chemical reaction in the inflators quickly fills the airbags with non-toxic gas to help restrain the motion of the occupants.

 **WARNING**

■ **SRS airbag precautions**

Observe the following precautions regarding the SRS airbags. Failure to do so may cause death or serious injury.

- The driver and all passengers in the vehicle must wear their seat belts properly.

The SRS airbags are supplemental devices to be used with the seat belts.

- The SRS driver airbag deploys with considerable force, and can cause death or serious injury especially if the driver is very close to the airbag.

Since the risk zone for the driver's airbag is the first 50 - 75 mm (2 - 3 in.) of inflation, placing yourself 250 mm (10 in.) from your driver airbag provides you with a clear margin of safety. This distance is measured from the center of the steering wheel to your breastbone. If you sit less than 250 mm (10 in.) away now, you can change your driving position in several ways:

- Move your seat to the rear as far as you can while still reaching the pedals comfortably.
- Slightly recline the back of the seat. Although vehicle designs vary, many drivers can achieve the 250 mm (10 in.) distance, even with the driver seat all the way forward, simply by reclining the back of the seat somewhat. If reclining the back of your seat makes it hard to see the road, raise yourself by using a firm, non-slippery cushion, or raise the seat if your vehicle has that feature.
- If your steering wheel is adjustable, tilt it downward. This points the airbag toward your chest instead of your head and neck.

The seat should be adjusted as recommended above, while still maintaining control of the foot pedals, steering wheel, and your view of the instrument panel controls.

⚠ WARNING

■ **SRS airbag precautions**

- The SRS front passenger airbag also deploys with considerable force, and can cause death or serious injury especially if the front passenger is very close to the airbag. The front passenger seat should be as far from the airbag as possible with the seatback adjusted, so the front passenger sits upright.
- Improperly seated and/or restrained infants and children can be killed or seriously injured by a deploying airbag. An infant or child who is too small to use a seat belt should be properly secured using a child restraint system. Toyota strongly recommends that all infants and children be placed in the rear seats of the vehicle and properly restrained. The rear seats are safer for infants and children than the front passenger seat. (→P. 53)
- Do not sit on the edge of the seat or lean against the dashboard.

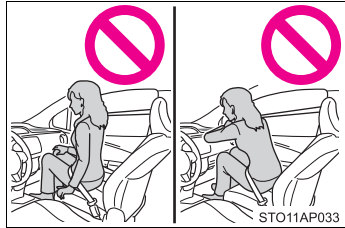

- Do not allow a child to stand in front of the SRS front passenger airbag unit or sit on the knees of a front passenger.
- Do not allow the front seat occupants to hold items on their knees.

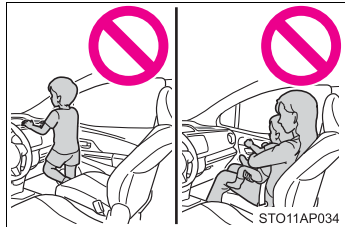

! WARNING

■ SRS airbag precautions

- Vehicles without SRS curtain shield airbags: Do not lean against the front door.
- Vehicles with SRS curtain shield airbags: Do not lean against the door, the roof side rail or the front, side and rear pillars.



- Do not allow anyone to kneel on the passenger seat toward the door or put their head or hands outside the vehicle.

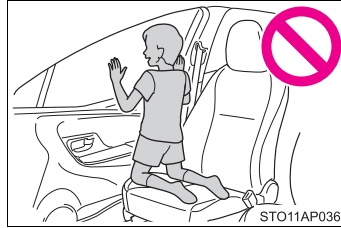

- Vehicles without an SRS driver knee airbag: Do not attach anything to or lean anything against areas such as the dashboard or steering wheel pad. These items can become projectiles when the SRS driver and front passenger airbags deploy.

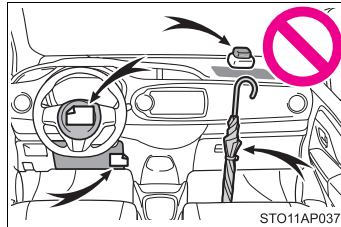

- Vehicles with an SRS driver knee airbag: Do not attach anything to or lean anything against areas such as the dashboard, steering wheel pad and lower portion of the instrument panel. These items can become projectiles when the SRS driver, front passenger and driver knee airbags deploy.

! WARNING

■ SRS airbag precautions

- Vehicles without SRS curtain shield airbags: Do not attach anything to areas such as a door, windshield glass and side door glass.
- Vehicles with SRS curtain shield airbags: Do not attach anything to areas such as a door, windshield glass, side door glass, front or rear pillar, roof side rail and assist grip. (Except for the speed limit label →P. 439)

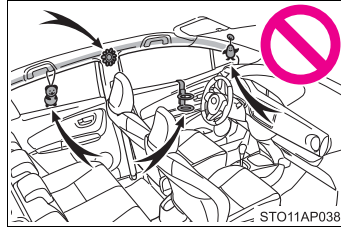

- Vehicles with an SRS driver knee airbag, but do not use a smart entry & start system: Do not attach any heavy, sharp or hard objects such as keys and accessories to the key. The objects may restrict the SRS driver knee airbag inflation or be thrust into the driver's seat area by the force of the deploying airbag, thus causing a danger.

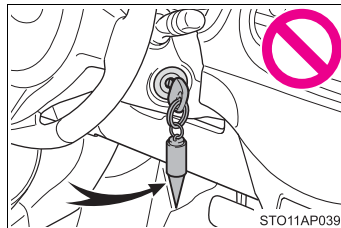

- Vehicles with SRS curtain shield airbags: Do not hang coat hangers or other hard objects on the coat hooks. All of these items could become projectiles and may cause death or serious injury, should the SRS curtain shield airbags deploy.
- Vehicles with an SRS driver knee airbag: If a vinyl cover is put on the area where the SRS driver knee airbag will deploy, be sure to remove it.
- Do not use seat accessories which cover the parts where the SRS side airbags inflate as they may interfere with inflation of the SRS airbags. Such accessories may prevent the side airbags from activating correctly, disable the system or cause the side airbags to inflate accidentally, resulting in death or serious injury.

 **WARNING****■ SRS airbag precautions**

- Do not strike or apply significant levels of force to the area of the SRS airbag components.
Doing so can cause the SRS airbags to malfunction.
- Do not touch any of the component parts immediately after the SRS airbags have deployed (inflated) as they may be hot.
- If breathing becomes difficult after the SRS airbags have deployed, open a door or window to allow fresh air in, or leave the vehicle if it is safe to do so. Wash off any residue as soon as possible to prevent skin irritation.
- Vehicles without SRS curtain shield airbags: If the areas where the SRS airbags are stored, such as the steering wheel pad, are damaged or cracked, have them replaced by any authorized Toyota dealer or repairer, or another duly qualified and equipped professional.
- Vehicles with SRS curtain shield airbags: If the areas where the SRS airbags are stored, such as the steering wheel pad and front and rear pillar garnishes, are damaged or cracked, have them replaced by any authorized Toyota dealer or repairer, or another duly qualified and equipped professional.

■ Modification and disposal of SRS airbag system components

Do not dispose of your vehicle or perform any of the following modifications without consulting any authorized Toyota dealer or repairer, or another duly qualified and equipped professional. The SRS airbags may malfunction or deploy (inflate) accidentally, causing death or serious injury.

- Installation, removal, disassembly and repair of the SRS airbags
- Repairs, modifications, removal or replacement of the steering wheel, instrument panel, dashboard, seats or seat upholstery, front, side and rear pillars or roof side rails
- Repairs or modifications of the front fender, front bumper, or side of the occupant compartment
- Installation of a grille guard (bull bars, kangaroo bar, etc.), snow plows, winches
- Modifications to the vehicle's suspension system
- Installation of electronic devices such as mobile two-way radios (RF-transmitter) and CD players

■ If the SRS airbags deploy (inflate)

- Bruising and slight abrasions may result from contact with a deploying (inflating) SRS airbag.
- A loud noise and white powder will be emitted.
- Vehicles without SRS curtain shield airbags: Parts of the airbag module (steering wheel hub, airbag cover and inflator) as well as the front seats may be hot for several minutes. The airbag itself may also be hot.
- Vehicles with SRS curtain shield airbags: Parts of the airbag module (steering wheel hub, airbag cover and inflator) as well as the front seats, parts of the front and rear pillars, and roof side rails, may be hot for several minutes. The airbag itself may also be hot.
- The windshield may crack.

■ SRS airbag deployment conditions (SRS front airbags)

- The SRS front airbags will deploy in the event of an impact that exceeds the set threshold level (the level of force corresponding to an approximately 20 - 30 km/h [12 - 18 mph] frontal collision with a fixed wall that does not move or deform).

However, this threshold velocity will be considerably higher in the following situations:

- If the vehicle strikes an object, such as a parked vehicle or sign pole, which can move or deform on impact
- If the vehicle is involved in an underride collision, such as a collision in which the front of the vehicle “underrides”, or goes under, the bed of a truck
- Depending on the type of collision, it is possible that only the seat belt pretensioners will activate.

■ SRS airbag deployment conditions (SRS side airbags and SRS curtain shield airbags [if equipped])

The SRS side and curtain shield airbags will deploy in the event of an impact that exceeds the set threshold level (the level of force corresponding to the impact force produced by an approximately 1500 kg [3300 lb.] vehicle colliding with the vehicle cabin from a direction perpendicular to the vehicle orientation at an approximate speed of 20 - 30 km/h [12 - 18 mph]).

■ Conditions under which the SRS airbags may deploy (inflate), other than a collision

The SRS front airbags may also deploy if a serious impact occurs to the underside of your vehicle. Some examples are shown in the illustration.

- Hitting a curb, edge of pavement or hard surface
- Falling into or jumping over a deep hole
- Landing hard or falling

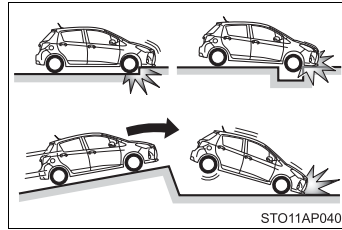

■ Types of collisions that may not deploy the SRS airbags (SRS front airbags)

The SRS front airbags do not generally inflate if the vehicle is involved in a side or rear collision, if it rolls over, or if it is involved in a low-speed frontal collision. But, whenever a collision of any type causes sufficient forward deceleration of the vehicle, deployment of the SRS front airbags may occur.

- Collision from the side
- Collision from the rear
- Vehicle rollover

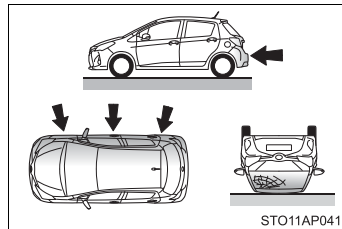

■ Types of collisions that may not deploy the SRS airbags (SRS side airbags and SRS curtain shield airbags [if equipped])

The SRS side and curtain shield airbags may not activate if the vehicle is subjected to a collision from the side at certain angles, or a collision to the side of the vehicle body other than the passenger compartment.

- Collision from the side to the vehicle body other than the passenger compartment
- Collision from the side at an angle

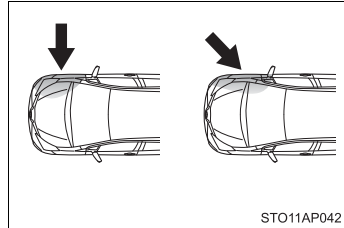

The SRS side and curtain shield airbags do not generally inflate if the vehicle is involved in a frontal or rear collision, if it rolls over, or if it is involved in a low-speed side collision.

- Collision from the front
- Collision from the rear
- Vehicle rollover

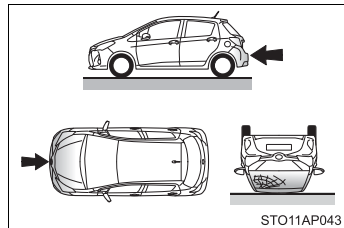

■ **When to contact any authorized Toyota dealer or repairer, or another duly qualified and equipped professional**

In the following cases, the vehicle will require inspection and/or repair. Contact any authorized Toyota dealer or repairer, or another duly qualified and equipped professional as soon as possible.

- Any of the SRS airbags have been inflated.
- The front of the vehicle is damaged or deformed, or was involved in an accident that was not severe enough to cause the SRS front airbags to inflate.

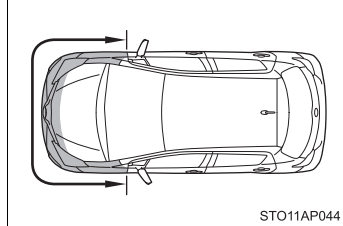

- A portion of a door is damaged or deformed, or the vehicle was involved in an accident that was not severe enough to cause the SRS side airbags and SRS curtain shield airbags (if equipped) to inflate.

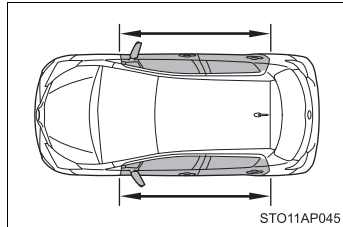

- Vehicles without an SRS driver knee airbag: The pad section of the steering wheel or dashboard near the front passenger airbag is scratched, cracked, or otherwise damaged.
- Vehicles with an SRS driver knee airbag: The pad section of the steering wheel, dashboard near the front passenger airbag or lower portion of the instrument panel is scratched, cracked, or otherwise damaged.

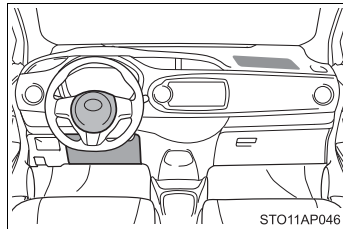

- The surface of the seats with the side airbag is scratched, cracked, or otherwise damaged.

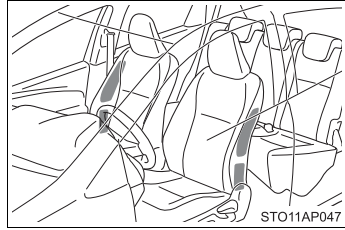

- Vehicles with SRS curtain shield airbags: The portion of the front pillars, rear pillars or roof side rail garnishes (padding) containing the curtain shield airbags is inside scratched, cracked, or otherwise damaged.

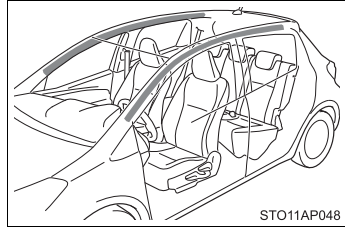

Airbag manual on-off system

**This system deactivates the front passenger airbag.
Only deactivate the airbags when using a child restraint system
on the front passenger seat.**

① “PASSENGER AIR BAG” indicator

- ▶ Vehicles without a smart entry & start system

This indicator light turns on when the airbag system is on (only when the engine switch is in the “ON” position).

- ▶ Vehicles with a smart entry & start system

This indicator light turns on when the airbag system is on (only when the engine switch is in IGNITION ON mode).

② Airbag manual on-off switch

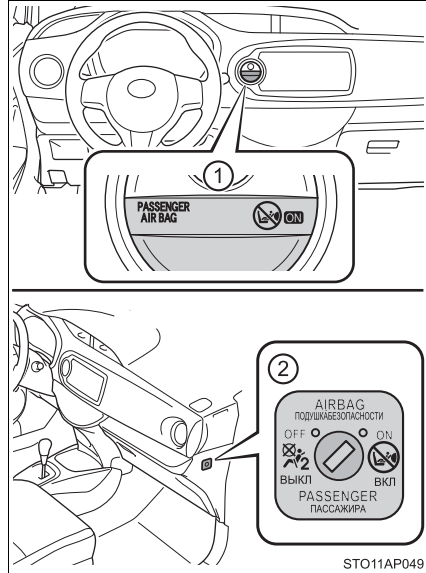

Deactivating the front seat passenger airbag

- ▶ Vehicles without a smart entry & start system

Insert the key into the cylinder and turn to the “OFF” position.

The “OFF” indicator light turns on (only when the engine switch is in the “ON” position).

- ▶ Vehicles with a smart entry & start system

Insert the mechanical key into the cylinder and turn to the “OFF” position.

The “OFF” indicator light turns on (only when the engine switch is in IGNITION ON mode).

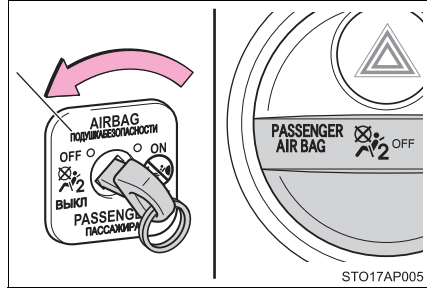

■ “PASSENGER AIR BAG” indicator information

If any of the following problems occur, it is possible that there is a malfunction in the system. Have the vehicle inspected by any authorized Toyota dealer or repairer, or another duly qualified and equipped professional.

- Neither “ON” nor “OFF” comes on.
- The indicator light does not change when the airbag manual on-off switch is switched to “ON” or “OFF”.

**WARNING****■ When installing a child restraint system**

For safety reasons, always install a child restraint system in a rear seat. In the event that the rear seat cannot be used, the front seat be used as long as the airbag manual on-off system is set to “OFF”.

If the airbag manual on-off system is left “ON”, the strong impact of the airbag deployment (inflation) may cause serious injury or even death.

■ When a child restraint system is not installed on the front passenger seat

Ensure that the airbag manual on-off system is set to “ON”.

If it is left “OFF”, the airbag may not deploy in the event of an accident, which may result in serious injury or even death.

Safety information for children

Observe the following precautions when children are in the vehicle.

Use a child restraint system appropriate for the child, until the child becomes large enough to properly wear the vehicle's seat belt.

- It is recommended that children sit in the rear seats to avoid accidental contact with the shift lever, wiper switch etc.
- Use the rear door child-protector lock or the window lock switch to avoid children opening the door while driving or operating the power window accidentally.
- Do not let small children operate equipment which may catch or pinch body parts, such as the power window, hood, back door, seats etc.



WARNING

Never leave children unattended in the vehicle, and never allow children to have or use the key.

Children may be able to start the vehicle or shift the vehicle into neutral. There is also a danger that children may injure themselves by playing with the windows or other features of the vehicle. In addition, heat build-up or extremely cold temperatures inside the vehicle can be fatal to children.

Child restraint systems

Toyota strongly urges the use of child restraint systems.

Points to remember

Studies have shown that installing a child restraint on a rear seat is much safer than installing one on the front passenger seat.

- Choose a child restraint system that suits your vehicle and is appropriate to the age and size of the child.
- For installation details, follow the instructions provided with the child restraint system.

General installation instructions are provided in this manual.

(→P. 63)

- If child restraint system regulations exist in the country where you reside, please contact any authorized Toyota dealer or repairer, or another duly qualified and equipped professional for the child restraint system installation.
- Toyota recommends that you use a child restraint system which conforms to the regulation ECE No.44.

Types of child restraints

Child restraint systems are classified into the following 5 groups according to the regulation ECE No.44:

Group 0: Up to 10 kg (22 lb.) (0 - 9 months)

Group 0⁺: Up to 13 kg (28 lb.) (0 - 2 years)

Group I: 9 to 18 kg (20 to 39 lb.) (9 months - 4 years)

Group II: 15 to 25 kg (34 to 55 lb.) (4 years - 7 years)

Group III: 22 to 36 kg (49 to 79 lb.) (6 years - 12 years)

In this owner's manual, the following 3 types of popular child restraint systems that can be secured with the seat belts are explained:

► Baby seat

Equal to Group 0 and 0⁺ of ECE No.44

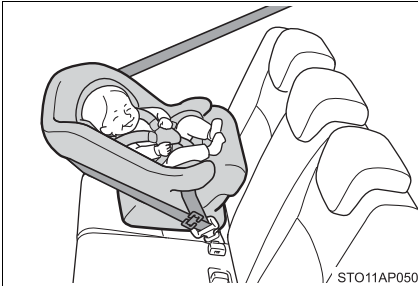

► Child seat

Equal to Group 0⁺ and I of ECE No.44



► Junior seat

Equal to Group II and III of ECE No.44



Child restraint system suitability for various seating positions

Information provided in the table shows your child restraint system suitability for various seating positions.

► Front passenger seat

Seating positions Mass groups	Front passenger seat		Recommended child restraint systems
	Airbag manual on-off switch		
	ON	OFF	
0 Up to 10 kg (22 lb.) (0 - 9 months)	X Never put	L	“TOYOTA G 0+, BABYSAFE” “TOYOTA G 0+, BABYSAFE PLUS” “TOYOTA G 0+, BABYSAFE PLUS with SEAT BELT FIXATION, BASE PLATFORM”
0+ Up to 13 kg (28 lb.) (0 - 2 years)	X Never put	L	“TOYOTA G 0+, BABYSAFE” “TOYOTA G 0+, BABYSAFE PLUS” “TOYOTA G 0+, BABYSAFE PLUS with SEAT BELT FIXATION, BASE PLATFORM”
I 9 to 18 kg (20 to 39 lb.) (9 months - 4 years)	Rear-facing — X Never put	UF*1	“TOYOTA DUO+”
	Forward-facing — UF*1		
II, III 15 to 36 kg (34 to 79 lb.) (4 - 12 years)	UF*1	UF*1	“TOYOTA KID” “TOYOTA KIDFIX”

NOTE:

Vehicles with a vertical height adjustment lever, must have the seat cushion adjusted to the highest position.

► Rear outer seats

Seating positions Mass groups	Right-hand	Left-hand	Recommended child restraint systems
0 Up to 10 kg (22 lb.) (0 - 9 months)	U	U	“TOYOTA G 0+, BABYSAFE” “TOYOTA G 0+, BABYSAFE PLUS” “TOYOTA G 0+, BABYSAFE PLUS with SEAT BELT FIXATION, BASE PLATFORM”
0 ⁺ Up to 13 kg (28 lb.) (0 - 2 years)	U	U	“TOYOTA G 0+, BABYSAFE” “TOYOTA G 0+, BABYSAFE PLUS” “TOYOTA G 0+, BABYSAFE PLUS with SEAT BELT FIXATION, BASE PLATFORM”
I 9 to 18 kg (20 to 39 lb.) (9 months - 4 years)	U	U	“TOYOTA DUO+”
II, III 15 to 36 kg (34 to 79 lb.) (4 - 12 years)	U	U	“TOYOTA KID” “TOYOTA KIDFIX”

► Rear center seat

Seating positions Mass groups	Center	Recommended child restraint systems
0 Up to 10 kg (22 lb.) (0 - 9 months)	L	"TOYOTA G 0+, BABYSAFE" "TOYOTA G 0+, BABYSAFE PLUS"
0+ Up to 13 kg (28 lb.) (0 - 2 years)	L	"TOYOTA G 0+, BABYSAFE" "TOYOTA G 0+, BABYSAFE PLUS"
I 9 to 18 kg (20 to 39 lb.) (9 months - 4 years)	L*2	"TOYOTA DUO+"
II, III 15 to 36 kg (34 to 79 lb.) (4 - 12 years)	L*2	"TOYOTA KID" "TOYOTA KIDFIX"

Key of letters inserted in the above table:

- U: Suitable for "universal" category child restraint system approved for the use in this mass group.
- UF: Suitable for forward-facing "universal" category child restraint system approved for the use in this mass group.
- L: Suitable for specific child seats. These child seats may be intended for use in a special car model, limited or semi-universal categories.
- X: Not suitable seat position for children in this mass group.
- *1: Adjust the front seat back to the most upright position. Move the front seat cushion to the fully rearward.
- *2: When you use a child restraint system in this position, remove the head restraint.

The child restraint systems mentioned in the table may not be available outside of the EU area. Other child restraint systems which are different from the systems mentioned in the table can be used, but the suitability of the systems must be carefully checked with the child restraint system manufacturer concerned and the seller of those seats.

Child restraint system suitability for various seating positions (with ISOFIX rigid anchors)

Information provided in the table shows your child restraint system suitability for various seating positions.

Mass groups	Size class	Fixture	Vehicle ISOFIX positions		Recommended child restraint systems
			Right-hand	Left-hand	
Carrycot	F	ISO/L1	X	X	—
	G	ISO/L2	X	X	—
		(1)	X	X	—
Group 0 Up to 10 kg (22 lb.)	E	ISO/R1	IL*1	IL*1	“TOYOTA G 0+, BABYSAFE PLUS with ISO-FIX FIXATION, BASE PLATFORM”
		(1)	X	X	—
Group 0+ Up to 13 kg (28 lb.)	E	ISO/R1	IL*1	IL*1	“TOYOTA G 0+, BABYSAFE PLUS with ISO-FIX FIXATION, BASE PLATFORM”
	D	ISO/R2	X	X	—
	C	ISO/R3	X	X	—
		(1)	X	X	—
Group I 9 to 18 kg (20 to 39 lb.)	D	ISO/R2	X	X	—
	C	ISO/R3	X	X	—
	B	ISO/F2	IUF*2	IUF*2	“TOYOTA DUO+”
	B1	ISO/F2X	IUF*2	IUF*2	
	A	ISO/F3	IUF*2	IUF*2	
		(1)	X	X	—
Group II 15 to 25 kg (34 to 55 lb.)		(1)	X	X	—
Group III 22 to 36 kg (49 to 79 lb.)		(1)	X	X	—

- (1) For the CRS which do not carry the ISO/XX size class identification (A to G), for the applicable mass group, the car manufacturer shall indicate the vehicle specific ISOFIX child restraint system(s) recommended for each position.

Key of letters inserted in the above table:

IUF: Suitable for ISOFIX forward-facing child restraint systems of universal category approved for the use in this mass group.

IL: Suitable for ISOFIX child restraint systems of the categories for “specific vehicles”, “restricted”, or “semiuniversal”, approved for this type of vehicle.

X: ISOFIX position not suitable for ISOFIX child restraint systems in this mass group and/or this size class.

*1: If the child seat is installed behind a front seat equipped with height adjuster and the front seat is adjusted below middle height position, then adjust the front seat head restraint to the highest position.

*2: When you use a child restraint system in this position, remove the head restraint.

The child restraint systems mentioned in the table may not be available outside of the EU area. Other child restraint systems different from the systems mentioned in the table can be used, but the suitability of the systems must be carefully checked with the child restraint system manufacturer and retailer.

■ When installing a child restraint system on the front passenger seat

When you have to use a child restraint system on the front passenger seat, adjust the following:

- The seatback to the most upright position
- The seat as far back as possible
- The seat cushion to the highest position (if equipped)

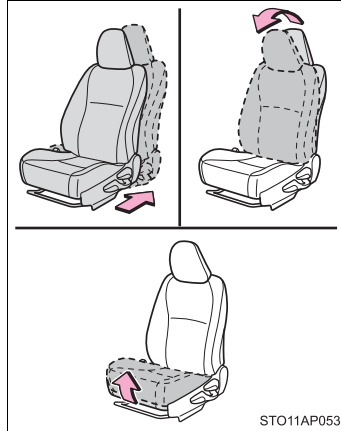

■ Selecting an appropriate child restraint system

- Use a child restraint system appropriate for the child until the child becomes large enough to properly wear the vehicle's seat belt.
- If the child is too large for a child restraint system, sit the child on a rear seat and use the vehicle's seat belt. (→P. 30)

⚠ WARNING

■ Using a child restraint system

The use of a child restraint system not suitable for the vehicle may not properly secure the infant or child. It may result in death or serious injury (in the event of sudden braking or an accident).

■ Child restraint precautions

- For effective protection in automobile accidents and sudden stops, a child must be properly restrained, using a seat belt or child restraint system depending on the age and size of the child. Holding a child in your arms is not a substitute for a child restraint system. In an accident, the child can be crushed against the windshield, or between you and the vehicle's interior.
- Toyota strongly urges the use of a proper child restraint system that conforms to the size of the child, installed on the rear seat. According to accident statistics, the child is safer when properly restrained in the rear seat than in the front seat.

 **WARNING****■ Child restraint precautions**

- Never use a rear-facing child restraint system on the front passenger seat when the airbag manual on-off switch is on. (→P. 49)
In the event of an accident, the force of the rapid inflation of the front passenger airbag can cause death or serious injury to the child.
- A forward-facing child restraint system may be installed on the front passenger seat only when it is unavoidable. A child restraint system that requires a top strap should not be used in the front passenger seat since there is no top strap anchor for the front passenger seat. Adjust the seat-back as upright as possible and always move the seat as far back as possible because the front passenger airbag could inflate with considerable speed and force. Otherwise, the child may be killed or seriously injured.
- Vehicles without SRS curtain shield airbags: Do not allow the child to lean his/her head or any part of his/her body against the door or the area of the seat from which the SRS side airbags deploy even if the child is seated in the child restraint system. It is dangerous if the SRS side airbags inflate, and the impact could cause death or serious injury to the child.
- Vehicles with SRS curtain shield airbags: Do not allow the child to lean his/her head or any part of his/her body against the door or the area of the seat, front and rear pillars or roof side rails from which the SRS side airbags or SRS curtain shield airbags deploy even if the child is seated in the child restraint system. It is dangerous if the SRS side airbags and curtain shield airbags inflate, and the impact could cause death or serious injury to the child.
- Make sure you have complied with all installation instructions provided by the child restraint manufacturer and that the system is properly secured. If it is not secured properly, it may cause death or serious injury to the child in the event of a sudden stop, sudden swerve or an accident.

**WARNING****■ When children are in the vehicle**

Do not allow children to play with the seat belt. If the seat belt becomes twisted around a child's neck, it may lead to choking or other serious injuries that could result in death.

If this occurs and the buckle cannot be unfastened, scissors should be used to cut the belt.

■ When the child restraint system is not in use

- Keep the child restraint system properly secured on the seat even if it is not in use. Do not store the child restraint system unsecured in the passenger compartment.
- If it is necessary to detach the child restraint system, remove it from the vehicle or store it securely in the luggage compartment. This will prevent it from injuring passengers in the event of a sudden stop, sudden swerve or an accident.

Installing child restraints

Follow the child restraint system manufacturer's instructions. Firmly secure child restraints to the seats using a seat belt or ISOFIX rigid anchors. Attach the top strap when installing a child restraint.

Seat belts (An ELR belt requires a locking clip)

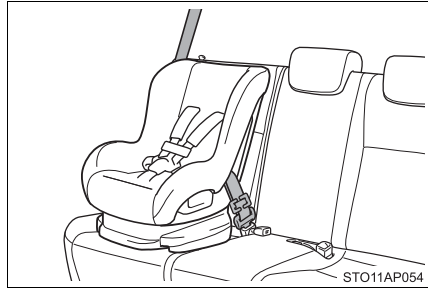

ISOFIX rigid anchors (ISOFIX child restraint system) (vehicles with rear seats)

Lower anchors are provided for the rear outer seats. (Tags displaying the location of the anchors are attached to the seats.)

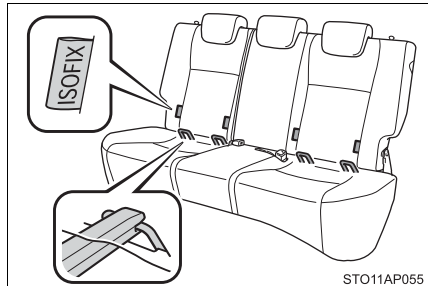

Anchor brackets (for top strap) (vehicles with rear seats)

An anchor bracket is provided for the rear outer seats.

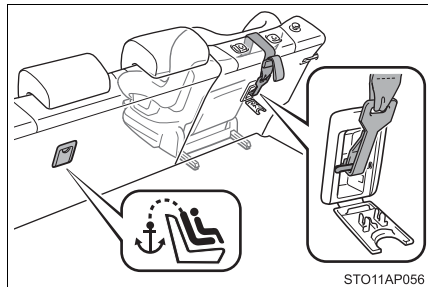

Installing child restraints using a seat belt

■ Rear-facing — Baby seat/child seat

- 1 Place the child restraint system on the rear seat facing the rear of the vehicle.

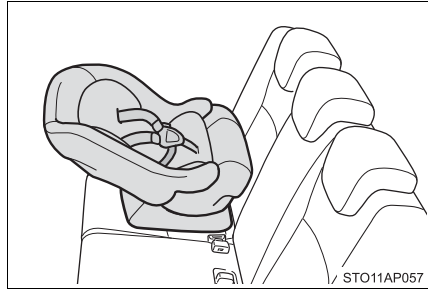

- 2 Run the seat belt through the child restraint system and insert the plate into the buckle. Make sure that the belt is not twisted.

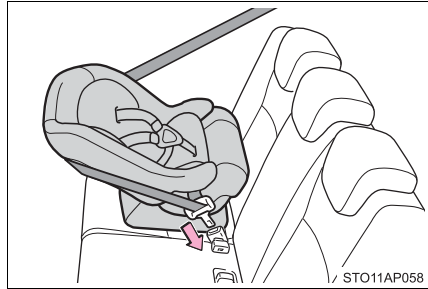

- 3 Install a locking clip near the tab of the lap and shoulder belt by inserting the lap and shoulder webbing through the recesses of the locking clip. Buckle the belt again. If the belt has any slack, release the buckle and reinstall the locking clip.

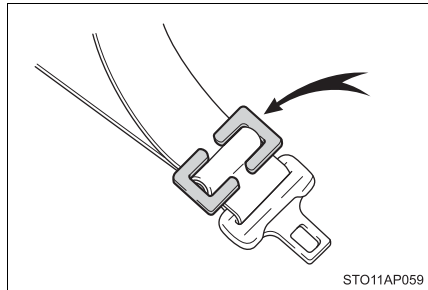

■ Forward-facing — Child seat

1 Remove the head restraint. (→P. 144)

2 Place the child restraint system on the seat facing the front of the vehicle.

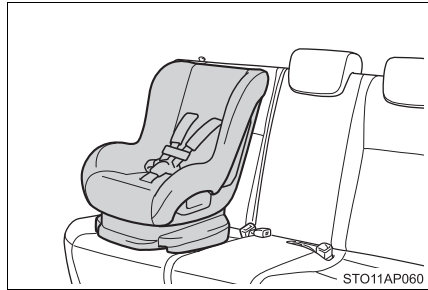

3 Run the seat belt through the child restraint system and insert the plate into the buckle. Make sure that the belt is not twisted.

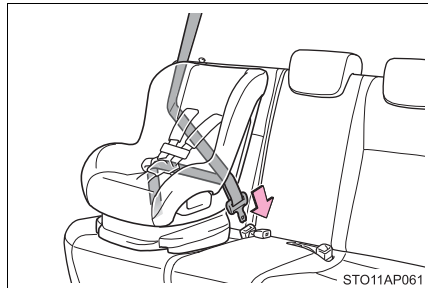

4 Install a locking clip near the tab of the lap and shoulder belt by inserting the lap and shoulder webbing through the recesses of the locking clip. Buckle the belt again. If the belt has any slack, release the buckle and reinstall the locking clip.

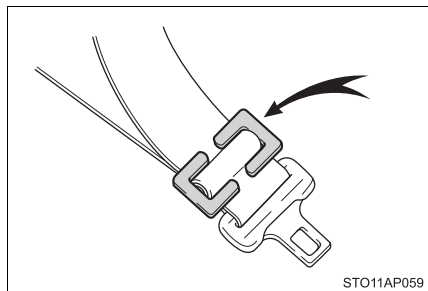

■ Junior seat

- 1 Place the child restraint system on the seat facing the front of the vehicle.

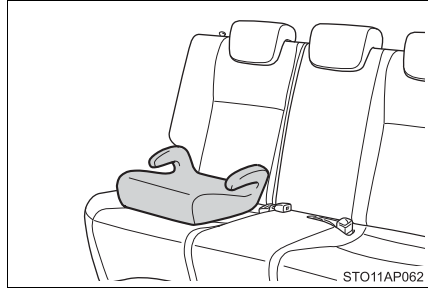

- 2 Sit the child in the child restraint system. Fit the seat belt to the child restraint system according to the manufacturer's instructions and insert the plate into the buckle. Make sure that the belt is not twisted.



Check that the shoulder belt is correctly positioned over the child's shoulder and that the lap belt is as low as possible. (→P. 30)

Removing a child restraint installed with a seat belt

Push the buckle release button and fully retract the seat belt.

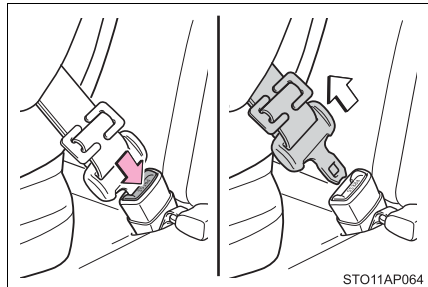

Installation with ISOFIX rigid anchors (ISOFIX child restraint system) (vehicles with rear seats)

- 1 Remove the head restraint. (→P. 144)
- 2 Widen the gap between the seat cushion and seatback slightly.
- 3 Latch the buckles onto the anchors.

If the child restraint has a top strap, the top strap should be latched onto the anchor bracket.

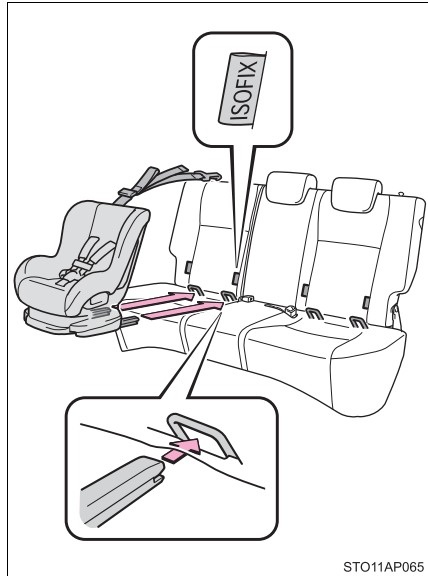

STO11AP065

Child restraint systems with a top strap (vehicles with rear seats)

- 1 Vehicles with a luggage cover: Remove the luggage cover.
(→P. 306)
- 2 Remove the head restraint. (→P. 144)
- 3 Secure the child restraint system using the seat belt or ISO-FIX rigid anchors.

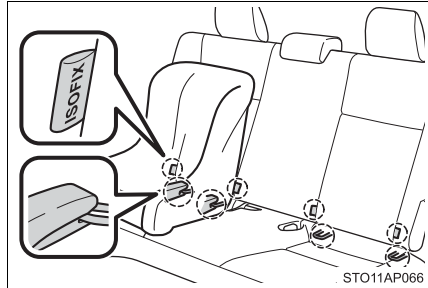

- 4 Open the anchor bracket cover, latch the hook onto the anchor bracket and tighten the top strap.

Make sure the top strap is securely latched.

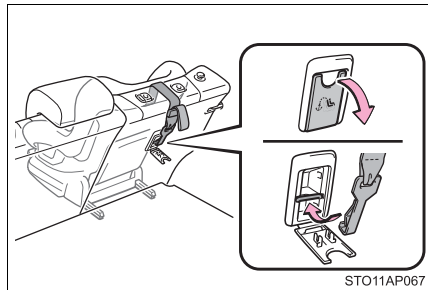

- 5 Vehicles with a luggage cover: Reinstall the luggage cover.

■ When installing a child restraint system using a seat belt

You need a locking clip to install the child restraint system using a seat belt. Follow the instructions provided by the manufacturer of the system. If your child restraint system does not provide a locking clip, you can purchase the following item from any authorized Toyota dealer or repairer, or another duly qualified and equipped professional:

Locking clip for child restraint system
(Part No. 73119-22010)

⚠ WARNING**■ When installing a child restraint system**

Follow the directions given in the child restraint system installation manual and fix the child restraint system securely in place.

If the child restraint system is not correctly fixed in place, the child or other passengers may be seriously injured or even killed in the event of a sudden braking, sudden swerving or an accident.

- If the driver's seat interferes with the child restraint system and prevents it from being attached correctly, attach the child restraint system to the rear right seat (left-hand drive vehicles) or the rear left seat (right-hand drive vehicles).
- Adjust the front passenger seat so that it does not interfere with the child restraint system.
- When installing a forward-facing child restraint system on the front passenger seat, move the seat as far back as possible.
Failure to do so may result in death or serious injury if the airbags deploy (inflate).

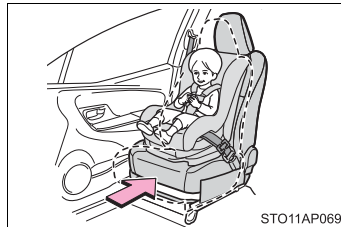
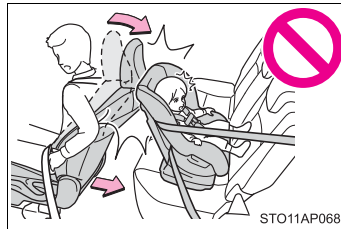

⚠ WARNING

■ **When installing a child restraint system**

- Never use a rear-facing child restraint system on the front passenger seat when the airbag manual on-off switch is on. (→P. 49)
The force of the rapid inflation of the front passenger airbag can cause death or serious injury to children in the event of an accident.

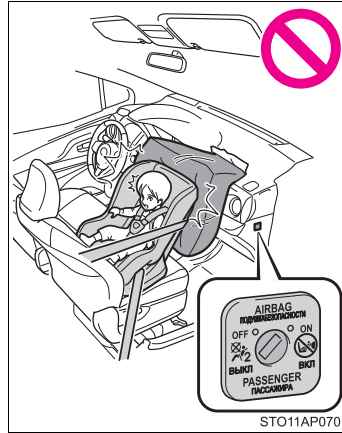

- There is a label(s) on the passenger side sun visor, indicating it is forbidden to attach a rear-facing child restraint system to the front passenger seat.
Details of the label(s) are shown in the illustration below.

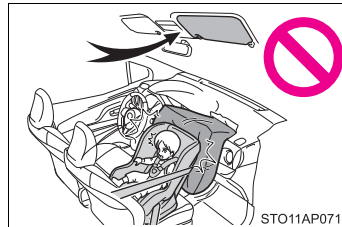

STS18AP001

 **WARNING****■ When installing a child restraint system**

- If child restraint system regulations exist in the country where you reside, please contact any authorized Toyota dealer or repairer, or another duly qualified and equipped professional for the child restraint system installation.
- When a junior seat is installed, always ensure that the shoulder belt is positioned across the center of the child's shoulder. The belt should be kept away from the child's neck, but not so that it could fall off the child's shoulder. Failure to do so may result in death or serious injury in the event of a sudden braking, sudden swerving or an accident.
- Ensure that the belt and plate are securely locked and the seat belt is not twisted.
- Shake the child restraint system left and right, and forward and backward to ensure that it has been securely installed.
- After securing a child restraint system, never adjust the seat.
- Follow all installation instructions provided by the child restraint system manufacturer.
- When a child restraint system with a top strap is installed, do not install the head restraint. The head restraint may interfere with the top strap preventing secure installation of the child restraint system.
- Make sure to properly store the removed head restraint in a secure place when you use the child restraint system on the rear seat.

⚠ WARNING**■ When installing a child restraint system**

- When using the rear right seat for the child restraint system, do not sit in the rear center seat. Seat belt function may be impaired, such as being positioned overly high or loose-fitting, which may result in death or serious injury in the event of sudden braking or an accident.

**■ To correctly attach a child restraint system to the anchors**

When using the lower anchors, be sure that there are no foreign objects around the anchors and that the seat belt is not caught behind the child restraint system. Make sure the child restraint system is securely attached, or it may cause death or serious injury to the child or other passengers in the event of a sudden braking, sudden swerve or an accident.

Exhaust gas precautions

Harmful substances to the human body are included in exhaust gases if inhaled.

WARNING

Exhaust gases contain harmful carbon monoxide (CO), which is colorless and odorless. Observe the following precautions.

Failure to do so may cause exhaust gases enter the vehicle and may lead to an accident caused by light-headedness, or may lead to death or a serious health hazard.

■ Important points while driving

- Keep the back door closed.
- If you smell exhaust gases in the vehicle even when the back door is closed, open the windows and have the vehicle inspected at any authorized Toyota dealer or repairer, or another duly qualified and equipped professional as soon as possible.

■ When parking

- If the vehicle is in a poorly ventilated area or a closed area, such as a garage, stop the engine.
- Do not leave the vehicle with the engine running for a long time. If such a situation cannot be avoided, park the vehicle in an open space and ensure that exhaust fumes do not enter the vehicle interior.
- Do not leave the engine running in an area with snow build-up, or where it is snowing. If snowbanks build up around the vehicle while the engine is running, exhaust gases may collect and enter the vehicle.

■ Exhaust pipe

The exhaust system needs to be checked periodically. If there is a hole or crack caused by corrosion, damage to a joint or abnormal exhaust noise, be sure to have the vehicle inspected and repaired by any authorized Toyota dealer or repairer, or another duly qualified and equipped professional.

Engine immobilizer system

The vehicle's keys have built-in transponder chips that prevent the engine from starting if a key has not been previously registered in the vehicle's on-board computer.

Never leave the keys inside the vehicle when you leave the vehicle.

This system is designed to help prevent vehicle theft but does not guarantee absolute security against all vehicle thefts.

▶ **Vehicles without a smart entry & start system**

The system begins operating after the key has been removed from the engine switch. The system is canceled after the registered key has been inserted into the engine switch.

▶ **Vehicles with a smart entry & start system**

The system begins operating after the engine switch has been turned off. The system is canceled after the engine switch has been turned to ACCESSORY or IGNITION ON mode.

■ **System maintenance**

The vehicle has a maintenance-free type engine immobilizer system.

■ **Conditions that may cause the system to malfunction**

- If the grip portion of the key is in contact with a metallic object
- If the key is in close proximity to or touching a key to the security system (key with a built-in transponder chip) of another vehicle

■ **Certifications for the engine immobilizer system (vehicles with a smart entry & start system)**

TOYOTA

TOYOTA MOTOR CORPORATION

1, TOYOTA-CHO, TOYOTA, AICHI, 471-8571, JAPAN TEL: +81-565-28-2121

R&TTE Declaration of Conformity

We,

Manufacturer's Name: TOYOTA MOTOR CORPORATION

Manufacturer's Address: 1, Toyota -cho, Toyota, Aichi, 471-8572, Japan

hereby declare under our sole responsibility that the product:

Product Name: Immobilizer

Product Model: TMIMB-3

to which this declaration relates is in conformity with the essential requirements and other relevant requirements of the R&TTE Directive (1999/5/EC). The product is compliant with the following standards and/or other normative documents:

-Health & safety requirements:	EN 60950-1
-EMC requirements	EN 301 489-01 & EN 301 489-03
-Effective uses of radio spectrum:	EN 300 330-2

Supplementary information:

* CE mark	
* Member states intended for use	EU and EFTA

Date: February 25, 2013

Signature:

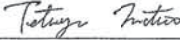
Tetsuya Matsuo

Hereby, Toyota Motor Corporation, declares that this TMIMB-3 is in compliance with the essential requirements and other relevant provisions of Directive 1999/5/EC.
Toyota Motor Corporation vakuuttaa täten että TMIMB-3 tyyppinen laite on direktiivin 1999/5/EY oleellisten vaatimusten ja sitä koskevien direktiivin muiden ehtojen mukainen.
Hierbij verklaart Toyota Motor Corporation dat het toestel TMIMB-3 in overeenstemming is met de essentiële eisen en de andere relevante bepalingen van richtlijn 1999/5/EG.
Par la présente Toyota Motor Corporation déclare que l'appareil TMIMB-3 est conforme aux exigences essentielles et aux autres dispositions pertinentes de la directive 1999/5/CE.
Härmed intygar Toyota Motor Corporation att denna TMIMB-3 står i överensstämmelse med de väsentliga egenskapskrav och övriga relevanta bestämmelser som framgår av direktiv 1999/5/EG.
Undertegnede Toyota Motor Corporation erklærer herved, at følgende udstyr TMIMB-3 overholder de væsentlige krav og øvrige relevante krav i direktiv 1999/5/EF.
Hiermit erklärt Toyota Motor Corporation, dass sich das Gerät TMIMB-3 in Übereinstimmung mit den grundlegenden Anforderungen und den übrigen einschlägigen Bestimmungen der Richtlinie 1999/5/EG befindet.
ΜΕ ΤΗΝ ΠΑΡΟΥΣΑ Toyota Motor Corporation ΔΗΛΩΝΕΙ ΟΤΙ ΤΜΙΜΒ-3 ΣΥΜΜΟΡΦΟΝΕΤΑΙ ΠΡΟΣ ΤΙΣ ΟΥΣΙΩΔΕΙΣ ΑΠΑΙΤΗΣΕΙΣ ΚΑΙ ΤΙΣ ΛΟΙΠΕΣ ΣΧΕΤΙΚΕΣ ΔΙΑΤΑΞΕΙΣ ΤΗΣ ΟΔΗΓΙΑΣ 1999/5/ΕΚ.
Con la presente Toyota Motor Corporation dichiara che questo TMIMB-3 è conforme ai requisiti essenziali ed alle altre disposizioni pertinenti stabilite dalla direttiva 1999/5/CE.
Por medio de la presente Toyota Motor Corporation declara que el TMIMB-3 cumple con los requisitos esenciales y cualesquiera otras disposiciones aplicables o exigibles de la Directiva 1999/5/CE.
Toyota Motor Corporation declara que este TMIMB-3 está conforme com os requisitos essenciais e outras disposições da Directiva 1999/5/CE.
Hawnhekk, Toyota Motor Corporation, jiddikjara li dan TMIMB-3 jikkonforma mal-hiġġijiet essenzjali u ma provvedimenti oħrajn relevanti ii hemm fid-Dirrettiva 1999/5/EC.
Käesolevaga kinnitab Toyota Motor Corporation seadme TMIMB-3 vastavust direktiivi 1999/5/EÜ põhinõuetele ja nimetatud direktiivist tulenevatele teistele asjakohastele sätetele.
Alulirovit, Toyota Motor Corporation nyilatkozom, hogy a TMIMB-3 megfelel a vonatkozó alapvető követelményeknek és az 1999/5/EC irányelv egyéb előírásainak.
Toyota Motor Corporation tímto vyhlásuje, že TMIMB-3 splňa základné požiadavky a všetky príslušné ustanovenia Smernice 1999/5/ES.
Toyota Motor Corporation tímto prohlašuje, že tento TMIMB-3 je ve shodě se základními požadavky a dalšími příslušnými ustanoveními směrnice 1999/5/ES.
Toyota Motor Corporation izjavlja, da je ta TMIMB-3 v skladu z bistvenimi zahtevami in ostalimi relevantnimi določili direktive 1999/5/ES.
Šiuo Toyota Motor Corporation deklaruoja, kad šis TMIMB-3 atitinka esminius reikalavimus ir kitas 1999/5/EB Direktyvos nuostatas.
Ar šo Toyota Motor Corporation deklarē, ka TMIMB-3 atbilst Direktīvas 1999/5/EK būtiskajām prasībām un citiem ar to saistītajiem noteikumiem.
Niniejszym Toyota Motor Corporation oświadcza, że TMIMB-3 jest zgodny z zasadniczymi wymogami oraz pozostałymi stosownymi postanowieniami Dyrektywy 1999/5/EC.
Hér með lýsir Toyota Motor Corporation yfir því að TMIMB-3 er í samræmi við grunnkröfur og aðrar kröfur, sem gerðar eru í tilskipun 1999/5/EC.
Toyota Motor Corporation erklærer herved at udstyret TMIMB-3 er i samsvar med de grundlæggende krav og øvrige relevante krav i direktiv 1999/5/EF.
С настоящего, Toyota Motor Corporation, декларира, че TMIMB-3 е в съответствие със съществените изисквания и другите приложими разпоредби на Директива 1999/5/EC.
Prin prezenta, Toyota Motor Corporation, declară că aparatul TMIMB-3 este în conformitate cu cerințele esențiale și cu alte prevederi pertinente ale Directivei 1999/5/CE.
Ovim, Toyota Motor Corporation, izjavljuje da ovaj TMIMB-3 je usklađen sa bitnim zahtjevima i drugim relevantnim odredbama Direktive 1999/5/EC.
Nepermijet kesaj, Toyota Motor Corporation, deklarjor qe ky TMIMB-3 eshte ne pajtim me kerkesat thelbesore dhe dispozitat e tjera perkatese te Direktives 1999/5/EC.
Ovim Toyota Motor Corporation, izjavljuje da je TMIMB-3 u skladu s bitnim zahtjevima i drugim relevantnim odredbama Direktive 1999/5/EC i Pravilnika o RITT opremi (NN 25/2012).
Ovim, Toyota Motor Corporation, deklarirše da je TMIMB-3 u skladu sa osnovnim zahtjevima i ostalim relevantnim odredbama Direktive 1999/5/EC.

■ Certifications for the engine immobilizer system (vehicles without a smart entry & start system)



The DECLARATION of CONFORMITY (DoC) is available at the following address:

<http://www.tokai-rika.co.jp/pc/>

Hereby, TRCZ s.r.o., declares that this RI-43BTY is in compliance with the essential requirements and other relevant provisions of Directive 1999/5/EC.
TRCZ s.r.o. vakuuttaa täten että RI-43BTY tyypinen laite on direktiivin 1999/5/EY oleellisten vaatimusten ja sitä koskevien direktiivin muiden ehtojen mukainen.
Hierbij verklaart TRCZ s.r.o. dat het toestel RI-43BTY in overeenstemming is met de essentiële eisen en de andere relevante bepalingen van richtlijn 1999/5/EG.
Par la présente TRCZ s.r.o. déclare que l'appareil RI-43BTY est conforme aux exigences essentielles et aux autres dispositions pertinentes de la directive 1999/5/CE.
Härmed intygar TRCZ s.r.o. att denna RI-43BTY står i överensstämmelse med de väsentliga egenskapskrav och övriga relevanta bestämmelser som framgår av direktiv 1999/5/EG.
Undertegnede TRCZ s.r.o. erklærer herved, at følgende udstyr RI-43BTY overholder de væsentlige krav og øvrige relevante krav i direktiv 1999/5/EF.
Hiermit erklart TRCZ s.r.o., dass sich das Gerät RI-43BTY in Übereinstimmung mit den grundlegenden Anforderungen und den übrigen einschlägigen Bestimmungen der Richtlinie 1999/5/EG befindet.
ME THN ΠΑΡΟΥΣΑ TRCZ s.r.o. ΔΗΛΩΝΕΙ ΟΤΙ RI-43BTY ΣΥΜΜΟΡΦΩΝΕΤΑΙ ΠΡΟΣ ΤΙΣ ΟΥΣΙΩΔΕΙΣ ΑΠΑΙΤΗΣΕΙΣ ΚΑΙ ΤΙΣ ΛΟΙΠΕΣ ΣΧΕΤΙΚΕΣ ΔΙΑΤΑΞΕΙΣ ΤΗΣ ΟΔΗΓΙΑΣ 1999/5/ΕΚ.
Con la presente TRCZ s.r.o. dichiara che questo RI-43BTY è conforme ai requisiti essenziali ed alle altre disposizioni pertinenti stabilite dalla direttiva 1999/5/CE.
Por medio de la presente TRCZ s.r.o. declara que el RI-43BTY cumple con los requisitos esenciales y cualesquiera otras disposiciones aplicables o exigibles de la Directiva 1999/5/CE.
TRCZ s.r.o. declara que este RI-43BTY está conforme con os requisitos essenciais e outras disposições da Directiva 1999/5/CE.
Havnhækk, TRCZ s.r.o., jidkijara li dan RI-43BTY jikkonforma mal-hitigjiet essenzjali u ma provvedimenti oħrajn relevanti li hemm fid-Direttiva 1999/5/EC.
Käesolevaga kinnitab TRCZ s.r.o. seadme RI-43BTY vastavust direktiivi 1999/5/EU põhinõuetele ja nimetatud direktiivist tulenevatele teistele asjakohastele sätetele.
Alulriiul, TRCZ s.r.o. nyilatkozom, hogy a RI-43BTY megfelel a vonatkozó alapvető követelményeknek és az 1999/5/EC irányelv egyéb előírásainak.
TRCZ s.r.o. týmto vyhlasuje, že RI-43BTY spĺňa základné požiadavky a všetky príslušné ustanovenia Smernice 1999/5/ES.
TRCZ s.r.o. tímto prohlašuje, že tento RI-43BTY je ve shodě se základními požadavky a dalšími příslušnými ustanoveními směrnice 1999/5/ES.
TRCZ s.r.o. izjavlja, da je ta RI-43BTY v skladu z bistvenimi zahtevami in ostalimi relevantnimi določili direktive 1999/5/ES.
Šiuo TRCZ s.r.o. deklaruoja, kad šis RI-43BTY atitinka esminius reikalavimus ir kitas 1999/5/EB Direktyvos nuostatas.
Ar šo TRCZ s.r.o. deklarē, ka RI-43BTY atbilst Direktīvas 1999/5/EK būtiskajām prasībām un citiem ar to saistītajiem noteikumiem.
Niniejszym TRCZ s.r.o. oświadcza, że RI-43BTY jest zgodny z zasadniczymi wymogami oraz pozostalymi stosownymi postanowieniami Dyrektywy 1999/5/EC.
Hér með lýsir TRCZ s.r.o. yfir því að RI-43BTY er í samræmi við grunnkröfur og aðrar kröfur, sem gerðar eru í tilskipun 1999/5/EC.
TRCZ s.r.o. erklærer herved at udstyret RI-43BTY er i samsvar med de grunnleggende krav og øvrige relevante krav i direktiv 1999/5/EF.
С настоящето, TRCZ s.r.o., декларира, че RI-43BTY е в съответствие със съществениите изисквания и другите приложими разпоредби на Директива 1999/5/EC.
Prin prezenta, TRCZ s.r.o., declară că aparatul RI-43BTY este în conformitate cu cerințele esențiale și cu alte prevederi pertinente ale Directivei 1999/5/CE.
Ovim, TRCZ s.r.o., izjavljuje da ovaj RI-43BTY je usklađen sa bitnim zahtjevima i drugim relevantnim odredbama Direktive 1999/5/EC.
Nepermetj kesaj, TRCZ s.r.o., deklaroj qe ky RI-43BTY eshte ne pajtim me kerkesat thelbese dhe dispozitat e tjera perkatese te Direktives 1999/5/EC.
Ovim TRCZ s.r.o., izjavljuje da je RI-43BTY u sklau s bitnim zahtjevima i drugim relevantnim odredbama Direktive 1999/5/EC i Pravinika o RITT opremi (NN 25/2012).
Ovim, TRCZ s.r.o., deklarirše da je RI-43BTY u skladu sa osnovnim zahtjevima i ostalim relevantnim odredbama Direktive 1999/5/EC.

**NOTICE****■ To ensure the system operates correctly**

Do not modify or remove the system. If modified or removed, the proper operation of the system cannot be guaranteed.

Double locking system*

Unauthorized access to the vehicle is prevented by disabling the door unlocking function from both the interior and exterior of the vehicle.

Vehicles employing this system have labels on the window glass of both front doors.

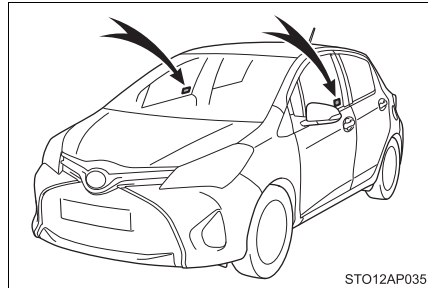

Setting the double locking system

Turn the engine switch to the “LOCK” position (vehicles without a smart entry & start system) or off (vehicles with a smart entry & start system), have all the passengers exit the vehicle and ensure that all the doors are closed.

Using the entry function (vehicles with a smart entry & start system):
Touch the sensor area on the outside door handle twice within 5 seconds.

Using the wireless remote control:
Press  twice within 5 seconds.

*: If equipped

Canceling the double locking system

Using the entry function (vehicles with a smart entry & start system):
Hold either front outside door handle or push up the back door opener switch.

Using the wireless remote control:

Press .

WARNING

■ Double locking system precaution

Never activate the double locking system when there are people in the vehicle because all the doors cannot be opened from inside the vehicle.

Instrument cluster

2

2. Instrument cluster

Warning lights and indicators	82
Gauges and meters	88
Multi-information display	90
Fuel consumption information	96

Warning lights and indicators

The warning lights and indicators on the instrument cluster and center panel inform the driver of the status of the vehicle's various systems.



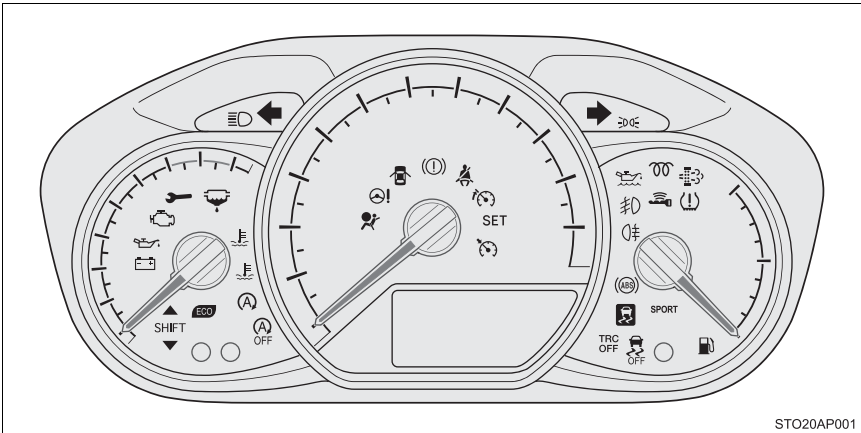















For the purpose of explanation, the following illustration displays all warning lights and indicators illuminated.



This illustration represents a meter with a tachometer and may differ from the look of the meter without a tachometer.

Warning lights

Warning lights inform the driver of malfunctions in the indicated vehicle's systems.

*1 	Brake system warning light (→P. 405)	*2 	Cruise control indicator light (→P. 407) (Yellow)
*1 	Charging system warning light (→P. 405)	*2 	Speed limiter indicator (→P. 407) (Yellow)
*1 	Low engine oil pressure warning light (→P. 405)	*1, 2, 5 	Stop & Start cancel indicator light (→P. 407)
*1 	High engine coolant temperature warning light (→P. 406) (Red)	*1, 6 	Fuel filter warning light (→P. 407)
*1 	Malfunction indicator lamp (→P. 406)	*2, 8 	DPF system warning light (→P. 409)
*1 	SRS warning light (→P. 406)	*2, 3 	Smart entry & start system indicator light (→P. 407) (Yellow)
*1 	ABS warning light (→P. 406)		Open door warning light (→P. 407)
*1 	Electric power steering system warning light (→P. 406)		Low fuel level warning light (→P. 408)
*1, 2, 4 	Slip indicator light (→P. 407)		Driver's and front passenger's seat belt reminder light (→P. 408)



Rear passengers' seat
belt reminder lights
(→P. 408)



Low engine oil level
warning light (→P. 409)



Tire pressure warning
light (→P. 408)



Engine oil change
reminder light (→P. 410)

- *1: These lights turn on when the engine switch is turned to the “ON” position (vehicles without a smart entry & start system) or IGNITION ON mode (vehicles with a smart entry & start system) to indicate that a system check is being performed. They will turn off after the engine is started, or after a few seconds. There may be a malfunction in a system if a light does not come on, or if the lights do not turn off. Have the vehicle inspected by any authorized Toyota dealer or repairer, or another duly qualified and equipped professional.
- *2: If equipped
- *3: The light flashes in yellow to indicate a malfunction. The light flashes quickly in green to indicate that the steering lock has not been released.
- *4: The light turns on to indicate a malfunction.
- *5: The light flashes to indicate a malfunction.
- *6: Diesel engine
- *7: The light illuminate on the center panel.
- *8: These lights turn on when the engine switch is turned to the “ON” position (vehicles without a smart entry & start system) or IGNITION ON mode (vehicles with a smart entry & start system) to indicate that a system check is being performed. They will turn off after the engine is started, or after a few seconds.

Indicators

The indicators inform the driver of the operating state of the vehicle's various systems.



Turn signal indicator
(→P. 200)



Headlight high beam indicator (→P. 203)



Tail light indicator
(→P. 202)



^{*2}
Front fog light indicator
(→P. 208)



Rear fog light indicator
(→P. 208)



(Green)

^{*2}
Smart entry & start system indicator light
(→P. 185)



(Blue)

^{*3}
Low engine coolant temperature indicator



^{*4}
Engine preheating indicator (→P. 182, 185)



^{*1, 5, 6}
Eco Driving Indicator Light (→P. 164)



^{*5}
"SPORT" indicator
(→P. 192)



^{*1, 7}
Gear Shift Indicator
(→P. 198)



(Green)

^{*2}
Cruise control indicator
(→P. 220)



^{*2}
"SET" indicator
(→P. 220)



(Green)

^{*2}
Speed limiter indicator
(→P. 224)



^{*1, 2}
Stop & Start indicator
(→P. 228)



^{*1, 2}
Stop & Start cancel indicator (→P. 229)



^{*1, 2, 8}
Slip indicator (→P. 236)



^{*1, 2}
"TRC OFF" indicator
(→P. 236)

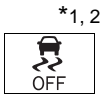

VSC OFF indicator
(→P. 237)



“PASSENGER AIR BAG” indicator
(→P. 49)

*1: Vehicles without a smart entry & start system:

These lights turn on when the engine switch is turned to the “ON” position to indicate that a system check is being performed. They will turn off after the engine is started, or after a few seconds. There may be a malfunction in a system if a light does not come on, or if the lights do not turn off. Have the vehicle inspected by any authorized Toyota dealer or repairer, or another duly qualified and equipped professional.

Vehicles with a smart entry & start system:

These lights turn on when the engine switch is turned to IGNITION ON mode to indicate that a system check is being performed. They will turn off after the engine is started, or after a few seconds. There may be a malfunction in a system if a light does not come on, or if the lights do not turn off. Have the vehicle inspected by any authorized Toyota dealer or repairer, or another duly qualified and equipped professional.

*2: If equipped

*3: This indicator turns on in blue when the engine coolant temperature is low.

*4: Diesel engine

*5: Vehicles with a Multidrive

*6: The light does not turn on when the system is disable.

*7: Vehicles with a manual transmission

*8: The light flashes to indicate that the system is operating.

*9: This light illuminates on the center panel.

 **WARNING****■ If a safety system warning light does not come on**

Should a safety system light such as the ABS and SRS warning light not come on when you start the engine, this could mean that these systems are not available to help protect you in an accident, which could result in death or serious injury. Have the vehicle inspected by any authorized Toyota dealer or repairer, or another duly qualified and equipped professional immediately if this occurs.

 **NOTICE****■ To prevent damage to the engine and its components**

The engine may be overheating if the high engine coolant temperature warning light flashes or turns on. In this case, immediately stop the vehicle in a safe place, and check the engine after it has cooled completely. (→P. 458)

Gauges and meters

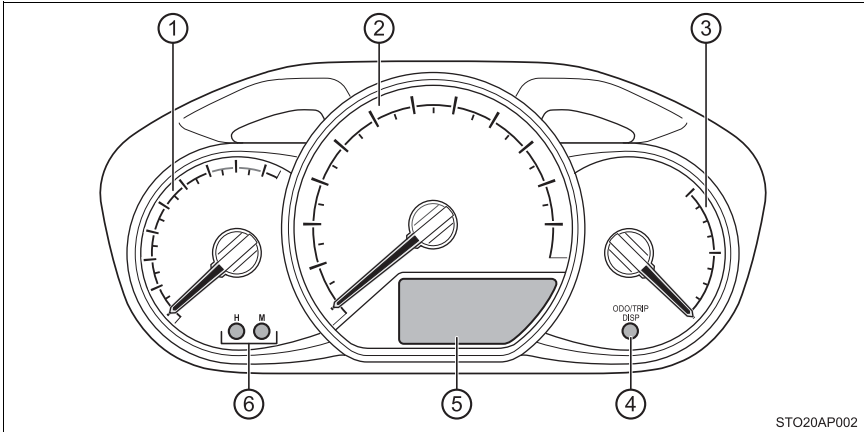

STO20AP002

- ① **Tachometer (if equipped)**
Displays the engine speed in revolutions per minute.
- ② **Speedometer**
Displays the vehicle speed.
- ③ **Fuel gauge (if equipped)**
Displays the quantity of fuel remaining in the tank.
- ④ **Display change button**
→P. 91
- ⑤ **Multi-information display**
Presents the driver with a variety of driving-related data. (→P. 90)
- ⑥ **Clock adjusting buttons**
→P. 93

Instrument panel light control

The brightness of the instrument panel lights (when the headlight switch is on) can be adjusted.

Display the instrument panel light control by pressing the display change button. (→P. 91)

Then, press and hold the button. Adjust the brightness to the desired level by pressing the button.

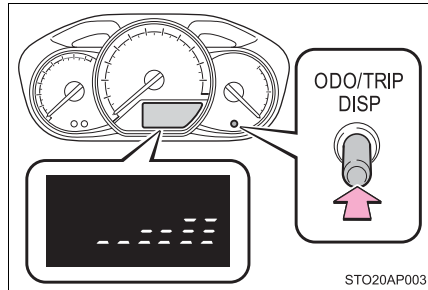

■ The meters and display illuminate when

- ▶ Vehicles without a smart entry & start system

The engine switch is in the "ON" position.

- ▶ Vehicles with a smart entry & start system

The engine switch is in IGNITION ON mode.



NOTICE

■ To prevent damage to the engine and its components

Vehicles with a tachometer: Do not let the indicator needle of the tachometer enter the red zone, which indicates the maximum engine speed.

Multi-information display

The multi-information display presents the driver with a variety of driving-related data including the clock.

Display contents

► Type A

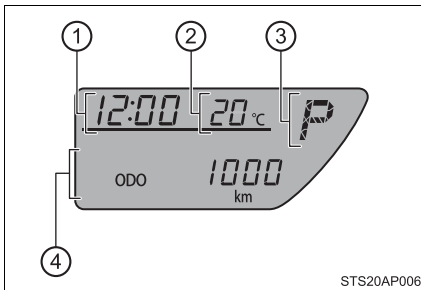

► Type B

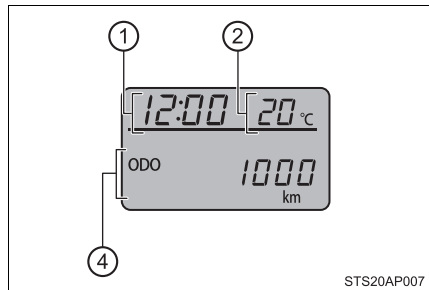

► Type C

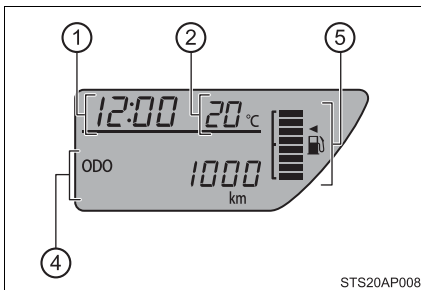

- ① Clock (→P. 93)
- ② Outside temperature display (→P. 94)
- ③ Shift position and gear step position indicator (→P. 191)
- ④ Drive information (→P. 91)
- ⑤ Fuel gauge

Changing the display

Items displayed can be switched by pressing the display change button.

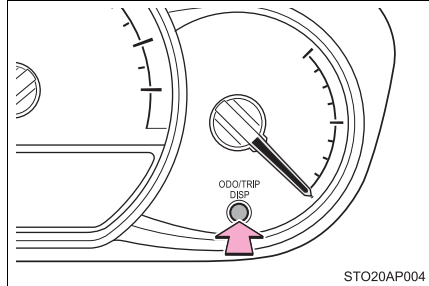

STO20AP004

Drive information

■ Odometer

Displays the total distance the vehicle has been driven.

■ Trip meter

Displays the distance the vehicle has been driven since the meter was last reset. Trip meters A and B can be used to record and display different distances independently.

Press and hold the button for longer than 1 second to reset. Pressing and holding the button while the trip meter is displayed will reset the trip meter to "0".

■ Driving range

Displays the estimated maximum distance that can be driven with the quantity of fuel remaining.

- This distance is computed based on your average fuel consumption. As a result, the actual distance that can be driven may differ from that displayed.
- When only a small amount of fuel is added to the tank, the display may not be updated.

When refueling, turn the engine switch to the "LOCK" position (vehicles without a smart entry & start system) or off (vehicles with a smart entry & start system). If the vehicle is refueled without turning the engine switch to the "LOCK" position or off, the display may not be updated.

■ Average fuel consumption

Displays the average rate of fuel consumption.

- The function can be reset by pressing the button for longer than 1 second when the average fuel consumption is displayed.
- Use the displayed average fuel consumption as a reference.

■ Instantaneous fuel consumption

Displays the instantaneous of fuel consumption.

Use the displayed instantaneous fuel consumption as a reference.

■ Average vehicle speed

Displays the average vehicle speed since the engine was last started.

■ Stop & Start system operation time (if equipped)

Displays the amount of time the engine was stopped due to operation of the Stop & Start system during the current trip.

Vehicles without a smart entry & start system:

From the engine switch in the "ON" position to the engine switch in the "LOCK" position.

Vehicles with a smart entry & start system:

From the engine switch in IGNITION ON mode to the engine switch off.

■ Stop & Start system total operation time (if equipped)

Displays the total amount of time that the engine has been stopped due to operation of the Stop & Start system since the system was last reset.

Press and hold the button to reset.

Eco Driving Indicator Light customization (if equipped)

Eco Driving Indicator Light can be activated or deactivated by pressing the display change button when the Eco Driving Indicator Light customization display is displayed.

To change the Eco Driving Indicator Light customization display, display the odometer and press and hold the display change button until the display changes.

After customization, press the display change button for more than 2 seconds to return to the odometer.

Clock

The clock can be adjusted by pressing the buttons.

- ① Adjust the hours
- ② Adjust the minutes

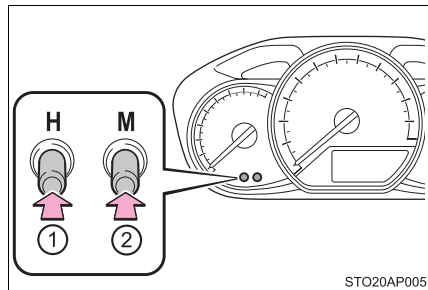

Outside temperature display

The temperature display shows temperatures within the range of -40°C (-40°F) and 50°C (122°F).

■ Display

In the following situations, the correct outside temperature may not be displayed, or the display may take longer than normal to change:

- When the vehicle is stopped, or moving at low speeds (less than 25 km/h [16 mph])
- When the outside temperature has changed suddenly (at the entrance/exit of a garage, tunnel, etc.)

■ When “-” or “E” is displayed

The system may be malfunctioning. Take your vehicle to any authorized Toyota dealer or repairer, or another duly qualified and equipped professional.

■ When disconnecting and reconnecting battery terminals

The following information data will be reset:

- Driving range
- Average fuel consumption
- Stop & Start system total operation time (if equipped)
- Average vehicle speed
- Clock data

■ Liquid crystal display

Small spots or light spots may appear on the display. This phenomenon is characteristic of liquid crystal display, and there is no problem continuing to use the display.

 **WARNING****■ Cautions during setting up the display**

As the engine needs to be running during setting up the display, ensure that the vehicle is parked in a place with adequate ventilation. In a closed area such as a garage, exhaust gases including harmful carbon monoxide (CO) may collect and enter the vehicle. This may lead to death or a serious health hazard.

 **NOTICE****■ The multi-information display at low temperatures**

Allow the interior of the vehicle to warm up before using the liquid crystal information display. At extremely low temperatures, the display monitor may respond slowly, and display changes may be delayed.

Fuel consumption information*

Fuel consumption information can be displayed on the navigation/multimedia system.

Navigation/multimedia system

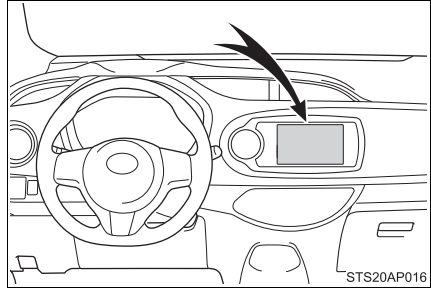

Trip information (navigation/multimedia system)

- 1 Press the  button on the navigation/multimedia system.

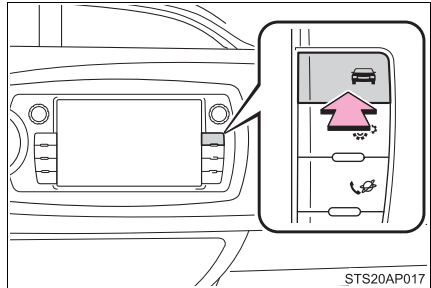

*: If equipped

- 2 Select "Trip information".
 - ① Average vehicle speed since the engine was started.
 - ② Cruising range (→P. 99)
 - ③ Fuel consumption in the past 15 minutes
 - ④ Elapsed time since the engine was started.
 - ⑤ Resetting the consumption data



Vehicles without a smart entry & start system:

Average fuel consumption for the past 15 minutes is divided by color into past averages and averages attained since the engine switch was last turned to the "ON" position. Use the displayed average fuel consumption as a reference.

Vehicles with a smart entry & start system:

Average fuel consumption for the past 15 minutes is divided by color into past averages and averages attained since the engine switch was last turned to IGNITION ON mode. Use the displayed average fuel consumption as a reference.

This image is an example only.

Past record (navigation/multimedia system)

- 1 Press the  button on the navigation/multimedia system.

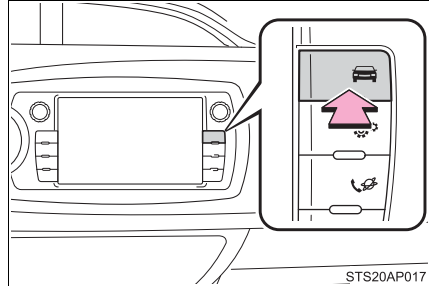

- 2 Select "Past record".
 - 1 Best recorded fuel consumption
 - 2 Previous fuel consumption record
 - 3 Average fuel consumption
 - 4 Updating the average fuel consumption data
 - 5 Resetting the past record data

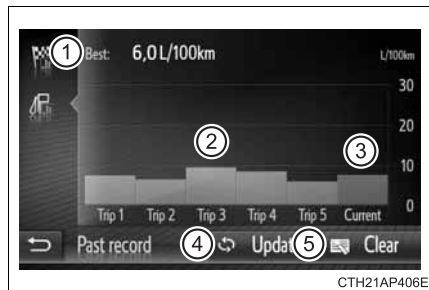

The average fuel consumption history is divided by color into past averages and the average fuel consumption since the last updated. Use the displayed average fuel consumption as a reference.

This image is an example only.

■ Updating the past record data

Update the average fuel consumption by selecting “Update” to measure the current fuel consumption again.

■ Resetting the data

The fuel consumption data can be deleted by selecting “Clear”.

■ Cruising range

Displays the estimated maximum distance that can be driven with the quantity of fuel remaining.

This distance is computed based on your average fuel consumption.

As a result, the actual distance that can be driven may differ from that displayed.

Operation of each component

3

- 3-1. Key information**
 - Keys..... 102
- 3-2. Opening, closing
and locking the doors**
 - Side doors..... 114
 - Back door..... 121
 - Smart entry &
start system 127
- 3-3. Adjusting the seats**
 - Front seats..... 138
 - Rear seats 141
 - Head restraints 144
- 3-4. Adjusting the steering
wheel and mirrors**
 - Steering wheel 146
 - Inside rear view mirror 148
 - Outside rear view mirrors... 151
- 3-5. Opening and closing
the windows**
 - Power windows..... 154

Keys

The keys

The following keys are provided with the vehicle.

▶ Vehicles without a smart entry & start system (type A)

- ① Keys
- ② Key number plate

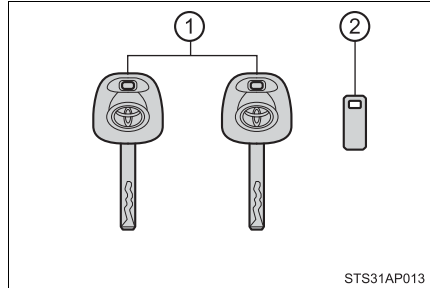

▶ Vehicles without a smart entry & start system (type B)

- ① Key (with a wireless remote control function)
Operating the wireless remote control function (→P. 115)
- ② Key (without a wireless remote control function)
- ③ Key number plate

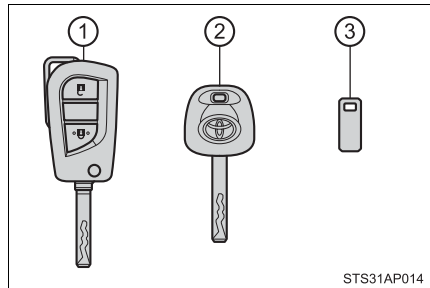

▶ Vehicles without a smart entry & start system (type C)

- ① Keys
Operating the wireless remote control function (→P. 115)
- ② Key number plate

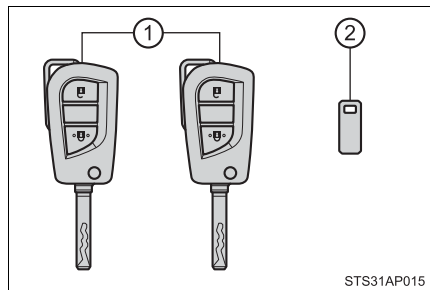

▶ Vehicles with a smart entry & start system

- ① Electronic keys
 - Operating the smart entry & start system (→P. 127)
 - Operating the wireless remote control function (→P. 115)
- ② Mechanical keys
- ③ Key number plate

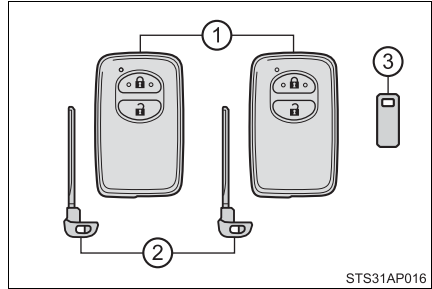

Wireless remote control

▶ Vehicles without a smart entry & start system

- ① Locks all the doors (→P. 115)
- ② Unlocks all the doors (→P. 115)

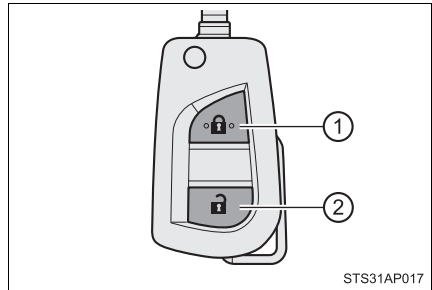

▶ Vehicles with a smart entry & start system

- ① Locks all the doors (→P. 115)
- ② Unlocks all the doors (→P. 115)

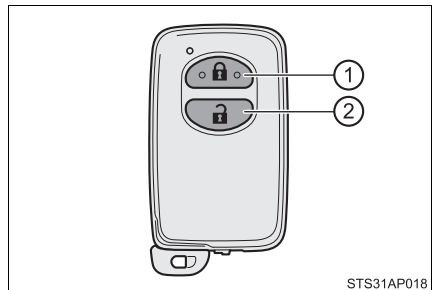

Using the master key (vehicles without a smart entry & start system)

Press the button to open the key.

To stow, press the button then fold the key.

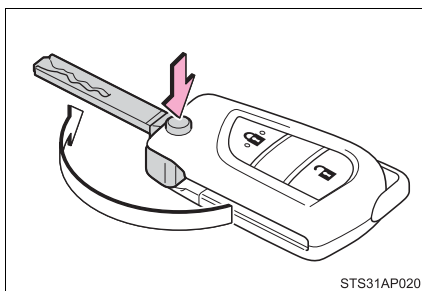

Using the mechanical key (vehicles with a smart entry & start system)

To take out the mechanical key, slide the release knob and take the key out.

After using the mechanical key, store it in the electronic key. Carry the mechanical key together with the electronic key. If the electronic key battery is depleted or the entry function does not operate properly, you will need the mechanical key. (→P. 451)

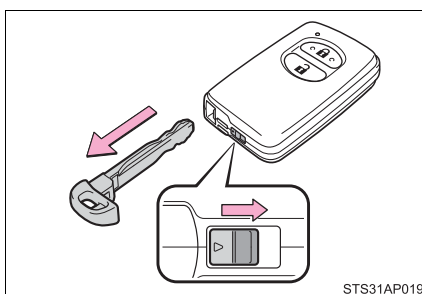

■ If you lose your keys

New genuine keys can be made by any authorized Toyota dealer or repairer, or another duly qualified and equipped professional using the other key and the key number stamped on your key number plate. Keep the plate in a safe place such as your wallet, not in the vehicle.

■ When riding in an aircraft

When bringing a key with wireless remote control function onto an aircraft, make sure you do not press any buttons on the key while inside the aircraft cabin. If you are carrying a key in your bag etc., ensure that the buttons are not likely to be pressed accidentally. Pressing a button may cause the key to emit radio waves that could interfere with the operation of the aircraft.

■ Conditions affecting operation (wireless remote control)

The wireless remote control function may not operate normally in the following situations:

- When the wireless key battery is depleted
- Near a TV tower, electric power plant, gas station, radio station, large display, airport or other facility that generates strong radio waves or electrical noise
- When carrying a portable radio, cellular phone or other wireless communication devices
- When the wireless key is in contact with, or is covered by a metallic object
- When other wireless keys (that emit radio waves) are being used nearby
- If window tint with a metallic content or metallic objects are attached to the rear window

■ Key battery depletion

If the wireless remote control function does not operate, the battery may be depleted. Replace the battery when necessary.

■ Electronic key battery depletion (vehicles with a smart entry & start system)

- The standard battery life is 1 to 2 years.
- If the battery becomes low, an alarm will sound in the cabin when the engine stops. (→P. 417)
- As the electronic key always receives radio waves, the battery will become depleted even if the electronic key is not used. The following symptoms indicate that the electronic key battery may be depleted. Replace the battery when necessary. (→P. 367)
 - The smart entry & start system or the wireless remote control does not operate.
 - The detection area becomes smaller.
 - The LED indicator on the key surface does not turn on.
- To avoid serious deterioration, do not leave the electronic key within 1 m (3 ft.) of the following electrical appliances that produce a magnetic field:
 - TVs
 - Personal computers
 - Cellular phones, cordless phones and battery chargers
 - Recharging cellular phones or cordless phones
 - Induction cookers
 - Table lamps

■ Replacing the battery

→P. 367

■ Confirmation of the registered key number (vehicles with a smart entry & start system)

The number of keys already registered to the vehicle can be confirmed. Ask any authorized Toyota dealer or repairer, or another duly qualified and equipped professional for details.

■ If a wrong key is used

On some models, the key cylinder rotates freely to isolate inside mechanism.

■ Customization

Settings (e.g. wireless remote control system) can be changed.
(Customizable features: →P. 490)

■ Certification for the wireless remote control (vehicles without a smart entry & start system)

 <p>Valeo Sécurité Habitacle Product Group Interior Electronics Business Group Comfort & Driving Assistance Systems</p>	<p>Comfort and Driving Assistance Systems</p>
<h3>Declaration of Conformity</h3> <p>in accordance with 1999/5/EC (R&TTE Directive)</p>	
<p>We,</p>	
<p>Manufacturer: Valeo Sécurité Habitacle - Product Group Interior Electronics</p>	
<p>Address: 76, rue Auguste Perret F-94046 Créteil - Cedex France</p>	
<p>hereby declare under our sole responsibility that the product:</p>	
<p>Product name: RF Receiver</p>	
<p>Model No.: A03RAA</p>	
<p>to which this declaration relates, complies with the essential protection requirements of R&TTE Directive (1999/5/ EC). The product is compliant with the following standards and/or normative documents:</p>	
<ul style="list-style-type: none"> - Efficient use of radio spectrum: - Electromagnetic compatibility: - Electrical Safety: 	<p>EN 300 220-1 V2.3.1 (2010-02), EN 300 220-2 V2.3.1 (2010-02) ETSI EN 301 489-1 V1.8.1 (2008-04) , EN 301 489-3 V1.4.1 (2002-08) IEC 60950-1: 2005 (2nd Edition)/A1:2009 and EN 60950-1:2006/A11:2009/A1:2010/A12: 2011</p>
<p>CE marking: </p>	
<p>Créteil, Nov.14, 2013</p>	
	
<p>Jérôme Hugot Certification & Regulation Engineer Valeo Sécurité Habitacle PG Interior Electronics BG Comfort & Driving Assistance Systems</p>	

Valeo Sécurité Habitable tímto prohlašuje, že tento A03RAA je ve shodě se základními požadavky a dalšími příslušnými ustanoveními směrnice 1999/5/ES.
Ovime, Valeo Sécurité Habitable izjavljuje da je model A03RAA je u skladu sa osnovnim zahtjevima i drugim relevantnim odredbama Direktive 1999/5/EC.
Undertegnede Valeo Sécurité Habitable erklærer herved, at følgende udstyr A03RAA overholder de væsentlige krav og øvrige relevante krav i direktiv 1999/5/EF.
Hiermit erklärt Valeo Sécurité Habitable, dass sich das Model A03RAA in Übereinstimmung mit den grundlegenden Anforderungen und den übrigen einschlägigen Bestimmungen der Richtlinie 1999/5/EG befindet.
Käesolevaga kinnitab Valeo Sécurité Habitable seadme A03RAA vastavust direktiivi 1999/5/EÜ põhinõuetele ja nimetatud direktiivist tulenevatele teistele asjakohastele sätetele.
Hereby, Valeo Sécurité Habitable declares that the model A03RAA is in compliance with the essential requirements and other relevant provisions of Directive 1999/5/EC.
Por medio de la presente Valeo Sécurité Habitable declara que A03RAA cumple con los requisitos esenciales y cualesquiera otras disposiciones aplicables o exigibles de la Directiva 1999/5/CE.
Με την παρούσα Valeo Sécurité Habitable δηλώνει ότι A03RAA συμμορφώνεται προς τις ουσιαστικές απαιτήσεις και τις λοιπές σχετικές διατάξεις της οδηγίας 1999/5/EK.
Par la présente Valeo Sécurité Habitable déclare que les appareils modèle A03RAA sont conformes aux exigences essentielles et aux autres dispositions pertinentes de la directive 1999/5/CE.
Con la presente Valeo Sécurité Habitable dichiara che questo A03RAA è conforme ai requisiti essenziali ed alle altre disposizioni pertinenti stabilite dalla direttiva 1999/5/CE.
Ar šo Valeo Sécurité Habitable deklarē, ka A03RAA atbilst Direktīvas 1999/5/EK būtiskajām prasībām un citiem ar to saistītajiem noteikumiem.
Šiuo Valeo Sécurité Habitable deklaruoja, kad šis A03RAA atitinka esminius reikalavimus ir kitas 1999/5/EB Direktyvos nuostatas.
Hierbij verklaart Valeo Sécurité Habitable dat het toestel A03RAA in overeenstemming is met de essentiële eisen en de andere relevante bepalingen van richtlijn 1999/5/EG.

Hawnhekk, Valeo Sécurité Habitacle , jiddikjara li dan A03RAA jikkonforma mal-htigijiet essenzjali u ma provvedimenti oħrajn relevanti li hemm fid-Dirrettiva 1999/5/EC.
Alulírott, Valeo Sécurité Habitacle nyilatkozom, hogy a A03RAA megfelel a vonatkozó alapvető követelményeknek és az 1999/5/EC irányelv egyéb előírásainak.
Niniejszym Valeo Sécurité Habitacle oświadcza, że A03RAA jest zgodny z zasadniczymi wymogami oraz pozostałymi stosownymi postanowieniami Dyrektywy 1999/5/EC.
Valeo Sécurité Habitacle declara que este A03RAA está conforme com os requisitos essenciais e outras disposições da Directiva 1999/5/CE.
Valeo Sécurité Habitacle izjavlja, da je ta A03RAA v skladu z bistvenimi zahtevami in ostalimi relevantnimi določili direktive 1999/5/ES.
Valeo Sécurité Habitacle týmto vyhlasuje, že A03RAA spĺňa základné požiadavky a všetky príslušné ustanovenia Smernice 1999/5/ES.
Valeo Sécurité Habitacle vakuuttaa täten että A03RAA tyyppinen laite on direktiivin 1999/5/EY oleellisten vaatimusten ja sitä koskevien direktiivin muiden ehtojen mukainen.
Härmed intygar Valeo Sécurité Habitacle att denna A03RAA står i överensstämmelse med de väsentliga egenskapskrav och övriga relevanta bestämmelser som framgår av direktiv 1999/5/EG.
Hér með lýsir Valeo Sécurité Habitacle yfir því að A03RAA er í samræmi við grunnkröfur og aðrar kröfur, sem gerðar eru í tilskipun 1999/5/EC.
Valeo Sécurité Habitacle erklærer herved at udstyret A03RAA er i samsvar med de grundlæggende krav og øvrige relevante krav i direktiv 1999/5/EF.
Ovime, Valeo Sécurité Habitacle izjavlja da je model A03RAA je u skladu sa osnovnim zahtjevima i drugim relevantnim odredbama Direktive 1999/5/EC.
Ovime, Valeo Sécurité Habitacle izjavlja da je model A03RAA je u skladu sa osnovnim zahtjevima i drugim relevantnim odredbama Direktive 1999/5/EC.
Овиме, Valeo Sécurité Habitacle изјављује да је А03РАА модел је у складу са основним захтевима и другим релевантним одредбама Директиве 1999/5/ЕЦ.



Comfort and Driving Assistance Systems

Valeo Sécurité Habitacle
Product Group Interior Electronics
Business Group Comfort & Driving Assistance Systems

Declaration of Conformity

in accordance with 1999/5/EC (R&TTE Directive)

We,

Manufacturer: Valeo Sécurité Habitacle - Product Group Interior Electronics

Address: 76, rue Auguste Perret
F-94046 Créteil - Cedex
France

hereby declare under our sole responsibility that the product:

Product name: RF Transmitter

Model No.: **A03TAA**

to which this declaration relates, complies with the essential protection requirements of R&TTE Directive (1999/5/ EC).
The product is compliant with the following standards and/or normative documents:

- Efficient use of radio spectrum: EN 300 220-1 V2.3.1 (2010-02), EN 300 220-2 V2.3.1 (2010-02)
- Electromagnetic compatibility: ETSI EN 301 489-1 V1.8.1 (2008-04) , EN 301 489-3 V1.4.1 (2002-08)
- Electrical Safety: IEC 60950-1: 2005 (2nd Edition)/A1:2009 and
EN 60950-1:2006/A11:2009/A1:2010

CE marking:

Créteil, Nov. 14, 2013

Jérôme Hugot
Certification & Regulation Engineer
Valeo Sécurité Habitacle
PG Interior Electronics
BG Comfort & Driving Assistance Systems

Valeo Sécurité Habitable tímto prohlašuje, že tento A03TAA je ve shodě se základními požadavky a dalšími příslušnými ustanoveními směrnice 1999/5/ES.
Ovime, Valeo Sécurité Habitable izjavljuje da je model A03TAA je u skladu sa osnovnim zahtjevima i drugim relevantnim odredbama Direktive 1999/5/EC.
Undertegnede Valeo Sécurité Habitable erklærer herved, at følgende udstyr A03TAA overholder de væsentlige krav og øvrige relevante krav i direktiv 1999/5/EF.
Hiermit erklärt Valeo Sécurité Habitable, dass sich das Model A03TAA in Übereinstimmung mit den grundlegenden Anforderungen und den übrigen einschlägigen Bestimmungen der Richtlinie 1999/5/EG befindet.
Käesolevaga kinnitab Valeo Sécurité Habitable seadme A03TAA vastavust direktiivi 1999/5/EÜ põhinõuetele ja nimetatud direktiivist tulenevatele teistele asjakohastele sätetele.
Hereby, Valeo Sécurité Habitable declares that the model A03TAA is in compliance with the essential requirements and other relevant provisions of Directive 1999/5/EC.
Por medio de la presente Valeo Sécurité Habitable declara que A03TAA cumple con los requisitos esenciales y cualesquiera otras disposiciones aplicables o exigibles de la Directiva 1999/5/CE.
Με την παρουσία Valeo Sécurité Habitable δηλώνει ότι A03TAA συμμορφώνεται προς τις ουσιαστικές απαιτήσεις και τις λοιπές σχετικές διατάξεις της οδηγίας 1999/5/EK.
Par la présente Valeo Sécurité Habitable déclare que les appareils modèle A03TAA sont conformes aux exigences essentielles et aux autres dispositions pertinentes de la directive 1999/5/CE.
Con la presente Valeo Sécurité Habitable dichiara che questo A03TAA è conforme ai requisiti essenziali ed alle altre disposizioni pertinenti stabilite dalla direttiva 1999/5/CE.
Ar šo Valeo Sécurité Habitable deklarē, ka A03TAA atbilst Direktīvas 1999/5/EK būtiskajām prasībām un citiem ar to saistītajiem noteikumiem.
Šiuo Valeo Sécurité Habitable deklaruoja, kad šis A03TAA atitinka esminius reikalavimus ir kitas 1999/5/EB Direktyvos nuostatas.
Hierbij verklaart Valeo Sécurité Habitable dat het toestel A03TAA in overeenstemming is met de essentiële eisen en de andere relevante bepalingen van richtlijn 1999/5/EG.

Hawnekk, Valeo Sécurité Habitable , jiddikjara li dan A03TAA jikkonforma mal-ftigijiet essenzjali u ma provvedimenti oħrajn relevanti li hemm fid-Dirrettiva 1999/5/EC.
Alulírótt, Valeo Sécurité Habitable nyilatkozom, hogy a A03TAA megfelel a vonatkozó alapvető követelményeknek és az 1999/5/EC irányelv egyéb előírásainak.
Niniejszym Valeo Sécurité Habitable oświadcza, że A03TAA jest zgodny z zasadniczymi wymogami oraz pozostałymi stosownymi postanowieniami Dyrektywy 1999/5/EC.
Valeo Sécurité Habitable declara que este A03TAA está conforme com os requisitos essenciais e outras disposições da Directiva 1999/5/CE.
Valeo Sécurité Habitable izjavlja, da je ta A03TAA v skladu z bistvenimi zahtevami in ostalimi relevantnimi določili direktive 1999/5/ES.
Valeo Sécurité Habitable týmto vyhlasuje, že A03TAA spĺňa základné požiadavky a všetky príslušné ustanovenia Smernice 1999/5/ES.
Valeo Sécurité Habitable vakuuttaa täten että A03TAA tyyppinen laite on direktiivin 1999/5/EY oleellisten vaatimusten ja sitä koskevien direktiivin muiden ehtojen mukainen.
Härmed intygar Valeo Sécurité Habitable att denna A03TAA står i överensstämmelse med de väsentliga egenskapskrav och övriga relevanta bestämmelser som framgår av direktiv 1999/5/EG.
Hér með lýsir Valeo Sécurité Habitable yfir því að A03TAA er í samræmi við grunnkröfur og aðrar kröfur, sem gerðar eru í tilskipun 1999/5/EC.
Valeo Sécurité Habitable erklærer herved at utstyret A03TAA er i samsvar med de grunnleggende krav og øvrige relevante krav i direktiv 1999/5/EF
Ovime, Valeo Sécurité Habitable izjavlja da je model A03TAA je u skladu sa osnovnim zahtjevima i drugim relevantnim odredbama Direktive 1999/5/EC.
Ovime, Valeo Sécurité Habitable izjavlja da je model A03TAA je u skladu sa osnovnim zahtjevima i drugim relevantnim odredbama Direktive 1999/5/EC.
Овиме, Valeo Sécurité Habitable изјављује да је А03ТАА модел је у складу са основним захтевима и другим релевантним одредбама Директиве 1999/5/ЕЦ.

 NOTICE**■ To prevent key damage**

- Do not drop the keys, subject them to strong shocks or bend them.
- Do not expose the keys to high temperatures for a long periods of time.
- Do not get the keys wet or wash them in an ultrasonic washer, etc.
- Do not attach metallic or magnetic materials to the keys or place the keys close to such materials.
- Do not disassemble the keys.
- Do not attach a sticker or anything else to the surface of the key.
- Vehicles with a smart entry & start system: Do not place the keys near objects that produce magnetic fields, such as TVs, audio systems, induction cookers, or medical electrical equipment, such as low-frequency therapy equipment.

■ Carrying the electronic key on your person (vehicles with a smart entry & start system)

Carry the electronic key 10 cm (3.9 in.) or more away from electric appliances that are turned on. Radio waves emitted from electric appliances within 10 cm (3.9 in.) of the electronic key may interfere with the key, causing the key to not function properly.

■ In case of a smart entry & start system malfunction or other key-related problems (vehicles with a smart entry & start system)

Take your vehicle with all the electronic keys provided with your vehicle to any authorized Toyota dealer or repairer, or another duly qualified and equipped professional.

■ When an electronic key is lost (vehicles with a smart entry & start system)

If the electronic key remains lost, the risk of vehicle theft increases significantly. Visit any authorized Toyota dealer or repairer, or another duly qualified and equipped professional immediately with all remaining electronic keys that were provided with your vehicle.

Side doors

Unlocking and locking the doors from the outside

The vehicle can be locked and unlocked using the entry function, wireless remote control, key or door lock switches.

◆ Entry function (vehicles with a smart entry & start system)

Carry the electronic key to enable this function.

- ① Grip the handle to unlock the doors.

Make sure to touch the sensor on the back of the handle.
The doors cannot be unlocked for 3 seconds after the doors are locked.

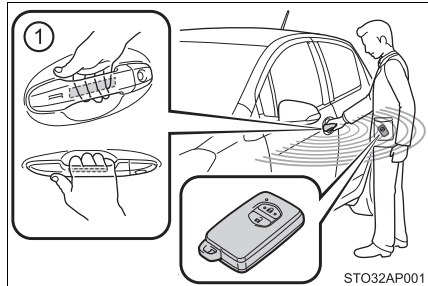

- ② Touch the lock sensor (the indentation on the side of the door handle) to lock the doors.

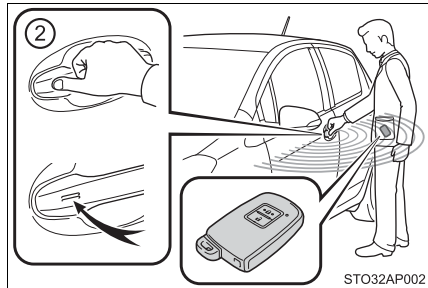

◆ Wireless remote control (if equipped)

▶ Vehicles without a smart entry & start system

- ① Locks all the doors
- ② Unlocks all the doors

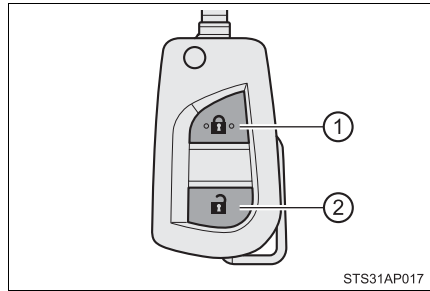

▶ Vehicles with a smart entry & start system

- ① Locks all the doors
- ② Unlocks all the doors

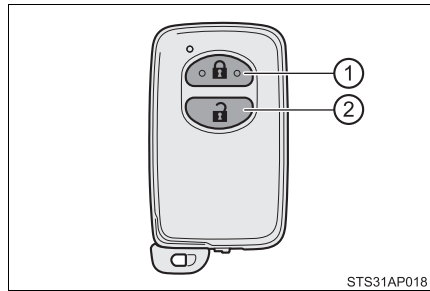

◆ Keys (vehicles without a smart entry & start system)

Turning the key operates the doors as follows:

■ Driver's door

- ① Locks all the doors
- ② Unlocks all the doors

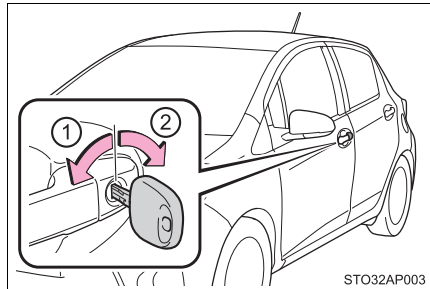

■ Front passenger's door (vehicles with a key cylinder)

- ① Locks the door
- ② Unlocks the door

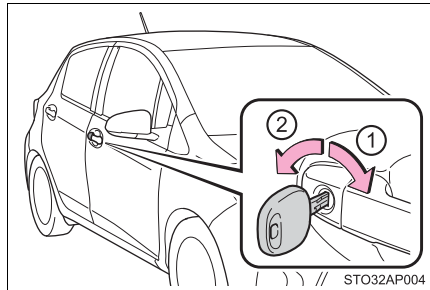

■ Operation signals (vehicles with an entry function or wireless remote control)

The emergency flashers flash to indicate that the doors have been locked/unlocked. (Locked: once; Unlocked: twice)

■ Security feature

▶ Vehicles without a smart entry & start system

If a door is not opened within approximately 30 seconds after the vehicle is unlocked, the security feature automatically locks the vehicle again.

▶ Vehicles with a smart entry & start system

If a door is not opened within approximately 30 seconds after the vehicle is unlocked, the security feature automatically locks the vehicle again. (However, depending on the location of the electronic key, the key may be detected as being in the vehicle. In this case, vehicle may be unlocked.)

■ When the door cannot be locked by the lock sensor (vehicles with a smart entry & start system)

Use your thumb to push lock sensor.

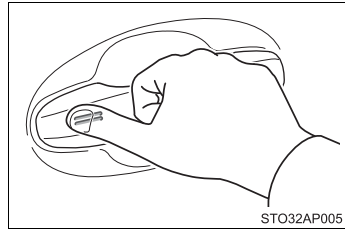

■ Door lock buzzer (vehicles with a smart entry & start system)

If an attempt to lock the doors is made when a door is not fully closed, a buzzer sounds continuously. Fully close the door to stop the buzzer, and lock the vehicle once more.

■ If the entry function (vehicles with a smart entry & start system) or the wireless remote control (if equipped) does not operate properly

- Vehicles without a smart entry & start system: Use the key to lock and unlock the doors. (→P. 116)
- Vehicles with a smart entry & start system: Use the mechanical key to lock and unlock the doors. (→P. 451)
- Replace the key battery with a new one if it is depleted. (→P. 367)

Unlocking and locking the doors from the inside

◆ Door lock switch

- ① Unlocks all the doors
- ② Locks all the doors

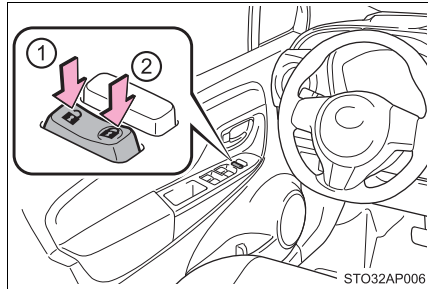

◆ Inside door lock buttons

- ① Locks the doors
- ② Unlocks the doors

The front doors can be opened by pulling the inside handle even if the inside door lock button is in the lock position.

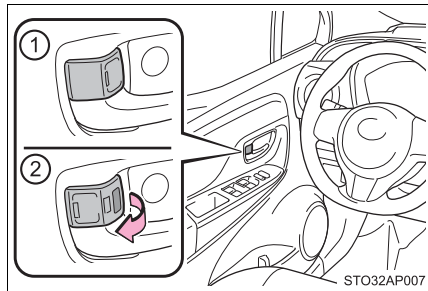

Locking the front doors from the outside without a key

- 1 Move the inside door lock button to the lock position.
- 2 Close the door while pulling the door handle.
 - ▶ Vehicles without a smart entry & start system

The door cannot be locked if the key is in the engine switch.

- ▶ Vehicles with a smart entry & start system

The door cannot be locked if the engine switch is in ACCESSORY or IGNITION ON mode, or the electronic key is left inside the vehicle. However, the key may not be detected correctly and the door may be locked.

Rear door child-protector lock (5-door models only)

The door cannot be opened from inside the vehicle when the lock is set.

- 1 Unlock
- 2 Lock

These locks can be set to prevent children from opening the rear doors. Push down on each rear door switch to lock both rear doors.



STO32AP008

■ Impact detection door lock release system

In the event that the vehicle is subject to a strong impact, all the doors are unlocked. Depending on the force of the impact or the type of accident, however, the system may not operate.

■ Using the mechanical key (vehicles with a smart entry & start system)

The doors can also be locked and unlocked with the mechanical key.
(→P. 451)

■ Conditions affecting the operation of the wireless remote control or smart entry & start system

→P. 105, 130

■ If the smart entry & start system has been deactivated in a customized setting (vehicles with a smart entry & start system)

Use the wireless remote control or mechanical key. (→P. 115, 451)

**WARNING****■ To prevent an accident**

Observe the following precautions while driving the vehicle.

Failure to do so may result in a door opening and an occupant falling out, resulting in death or serious injury.

- Always use a seat belt.

- Ensure that all the doors are properly closed.

- Do not pull the inside handle of the doors while driving.

The doors may be opened and the passengers are thrown out of the vehicle and it may result in serious injury or death.

Be especially careful for the front doors, as the doors may be opened even if the inside lock buttons are in locked position.

- Set the rear door child-protector locks when children are seated in the rear seats.

Back door

The back door can be locked/unlocked and opened by the following procedures.

Unlocking and locking the back door

◆ Door lock switch

→P. 118

◆ Entry function (vehicles with a smart entry & start system)

Carry the electronic key to enable this function.

- ① Press the button to unlock the door.

The door cannot be unlocked for 3 seconds after the door is locked.

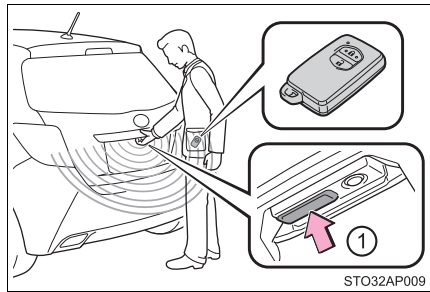

- ② Press the button to lock the door.

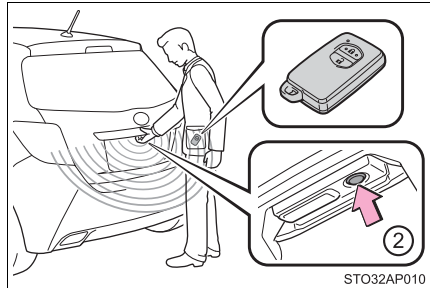

◆ Wireless remote control (if equipped)

→P. 115

◆ Keys

From the back door (vehicles with a back door key cylinder):

- ① Unlocks all the doors
- ② Locks all the doors

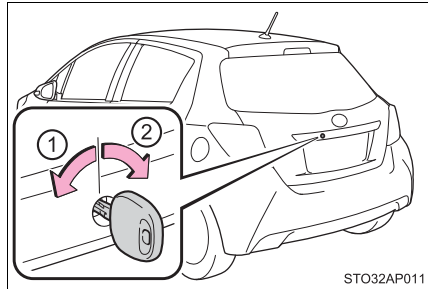

From the driver's door: →P. 116

Opening the back door from the outside the vehicle (vehicles with a smart entry & start system)

Raise the back door while pushing up the back door opener switch.

The back door cannot be closed immediately after the back door opener switch is pushed.

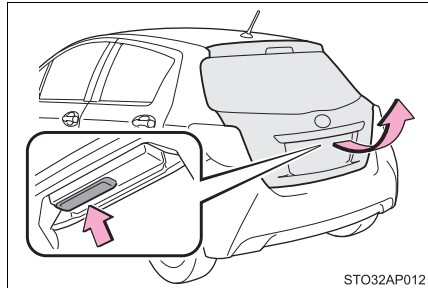

When closing the back door

Lower the back door using the back door handle, and make sure to push the back door down from the outside to close it.

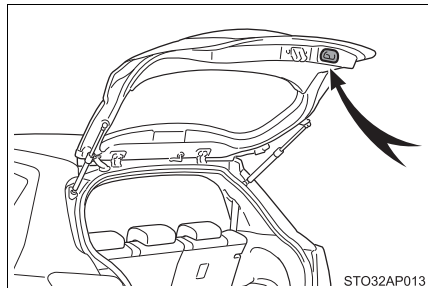

- **Operation signals (vehicles with an entry function or wireless remote control)**
→P. 116
- **Security feature**
→P. 117
- **Door lock buzzer (vehicles with a smart entry & start system)**
→P. 117
- **Luggage compartment light**
The luggage compartment lights turn on when the back door is opened.
- **If the smart entry & start system has been deactivated in a customized setting (vehicles with a smart entry & start system)**
Use the wireless remote control or mechanical key. (→P. 115, 451)
- **If the entry function (vehicles with a smart entry & start system) or the wireless remote control (if equipped) does not operate properly**
 - Vehicles without a smart entry & start system: Use the key to lock and unlock the back door. (→P. 116)
 - Vehicles with a smart entry & start system: Use the mechanical key to unlock the back door. (→P. 451)
 - Replace the key battery with a new one if it is depleted. (→P. 367)

 **WARNING**

Observe the following precautions.

Failure to do so may result in death or serious injury.

■ **Before driving**

- Make sure that the back door is fully closed. If the back door is not fully closed, it may open unexpectedly while driving and hit near-by objects or luggage in the luggage compartment may be thrown out, causing an accident.
- Do not allow children to play in the luggage compartment.
If a child is accidentally locked in the luggage compartment, they could have heat exhaustion or other injuries.
- Do not allow a child to open or close the back door.
Doing so may cause the back door to open unexpectedly, or cause the child's hands, head, or neck to be caught by the closing back door.

■ **Important points while driving**

- Keep the back door closed while driving.
If the back door is left open, it may hit near-by objects or luggage in the luggage compartment may be thrown out, causing an accident.
- Never let anyone sit in the luggage compartment. In the event of sudden braking or a collision, they are susceptible to death or serious injury.

■ **Operating the back door**

Observe the following precautions.

Failure to do so may cause parts of the body to be caught, resulting in death or serious injury.

- Remove any heavy loads, such as snow and ice, from the back door before opening it. Failure to do so may cause the back door to suddenly shut again after it is opened.
- When opening or closing the back door, thoroughly check to make sure the surrounding area is safe.

⚠ WARNING

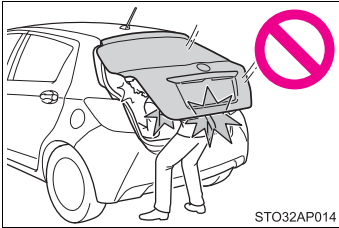
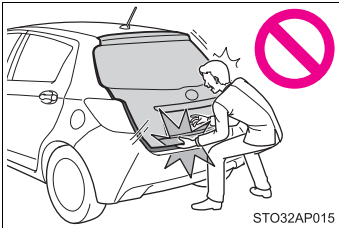
- If anyone is in the vicinity, make sure they are safe and let them know that the back door is about to open or close.
- Use caution when opening or closing the back door in windy weather as it may move abruptly in strong wind.
- The back door may suddenly shut if it is not opened fully. It is more difficult to open or close the back door on an incline than on a level surface, so beware of the back door unexpectedly opening or closing by itself. Make sure that the back door is fully open and secure before using the luggage compartment.
 
- When closing the back door, take extra care to prevent your fingers, etc., from being caught.
- When closing the back door, make sure to press it lightly on its outer surface. If the back door handle is used to fully close the back door, it may result in hands or arms being caught.
 
- Do not pull on the back door damper stay to close the back door, and do not hang on the back door damper stay. Doing so may cause hands to be caught or the back door damper stay to break, causing an accident.
- If a bicycle carrier or similar heavy object is attached to the back door, it may suddenly shut again after being opened, causing someone's hands, head or neck to be caught and injured. When installing an accessory part to the back door, using a genuine Toyota part is recommended.

 NOTICE**■ Back door damper stays**

The back door is equipped with damper stays that hold the back door in place.

Observe the following precautions.

Failure to do so may cause damage to the back door damper stay, resulting in malfunction.

- Do not attach any foreign objects, such as stickers, plastic sheets, or adhesives to the damper stay rod.
- Do not touch the damper stay rod with gloves or other fabric items.
- Do not attach any accessories other than genuine Toyota parts to the back door.
- Do not place your hand on the damper stay or apply lateral forces to it.

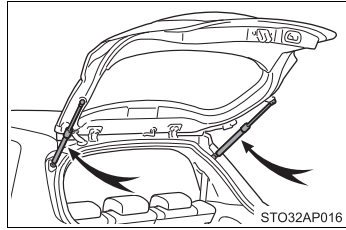

Smart entry & start system*

The following operations can be performed simply by carrying the electronic key on your person, for example in your pocket. (The driver should always carry the electronic key.)

- Locks and unlocks the side doors (→P. 114)
- Locks and unlocks the back door (→P. 121)
- Starts and stops the engine (→P. 185)

■ Antenna location

- ① Antennas outside the cabin
- ② Antennas inside the cabin
- ③ Antenna outside the luggage compartment

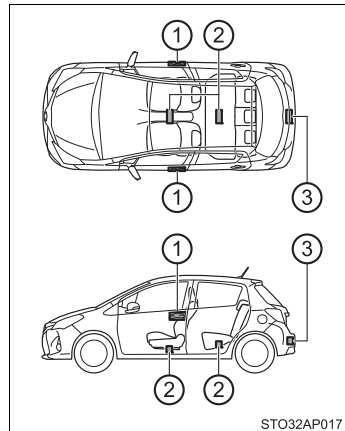

■ Effective range (areas within which the electronic key is detected)

- When locking or unlocking the doors

The system can be operated when the electronic key is within about 0.7 m (2.3 ft.) either of the outside front door handles and back door. (Only the doors detecting the key can be operated.)

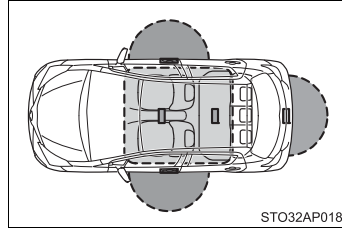

- When starting the engine or changing engine switch modes

The system can be operated when the electronic key is inside the vehicle.

■ Alarms and warning indicators

A combination of exterior and interior alarms as well as warning lights are used to prevent theft of the vehicle and unforeseeable accidents resulting from erroneous operation. Take appropriate measures for the warning light that comes on. (→P. 415)

The following table describes circumstances and correction procedures when only alarms are sounded.

Alarm	Situation/Actions
Exterior alarm sounds once for 5 seconds	<ul style="list-style-type: none"> • An attempt was made to lock the doors using the smart entry & start system while the electronic key was still inside the vehicle. →Retrieve the electronic key from the vehicle and lock the doors again. • An attempt was made to lock the vehicle while a door was open. →Close all of the doors and lock the doors again.
Interior alarm pings once and exterior alarm sounds once for 5 seconds	<p>An attempt was made to lock either front door by opening a door and putting the inside lock button into the lock position, then closing the door by pulling on the outside door handle with the electronic key still inside the vehicle. →Retrieve the electronic key from the vehicle and lock the doors again.</p>

Alarm	Situation/Actions
Interior alarm pings once and exterior alarm sounds once for 5 seconds (on some models)	An attempt was made to lock the doors other than using the smart entry & start system while the electronic key was still inside the vehicle. → Retrieve the electronic key from the vehicle and lock the doors again.
Interior alarm sounds continuously	The engine switch was turned to ACCESSORY mode while the driver's door was open (or the driver's door was opened while the engine switch was in ACCESSORY mode). → Turn the engine switch off and close the driver's door.
Interior alarm sounds continuously*	The driver's door was opened while any shift position other than P was selected without turning off the engine switch. → Shift the shift lever to P.

*: Vehicles with a Multidrive only

■ Battery-saving function

The battery-saving function will be activated in order to prevent the electronic key battery and the vehicle battery from being discharged while the vehicle is not in operation for a long time.

- In the following situations, the smart entry & start system may take some time to unlock the doors.
 - The electronic key has been left in an area of approximately 2 m (6 ft.) of the outside of the vehicle for 10 minutes or longer.
 - The smart entry & start system has not been used for 5 days or longer.
- If the smart entry & start system has not been used for 14 days or longer, the doors cannot be unlocked at any doors except the driver's door. In this case, take hold of the driver's door handle, or use the wireless remote control or the mechanical key, to unlock the doors.

■ Conditions affecting operation

The smart entry & start system uses weak radio waves. In the following situations, the communication between the electronic key and the vehicle may be affected, preventing the smart entry & start system, wireless remote control and engine immobilizer system from operating properly.

(Ways of coping: →P. 451)

- When the electronic key battery is depleted
- Near a TV tower, electric power plant, gas station, radio station, large display, airport or other facility that generates strong radio waves or electrical noise
- When the electronic key is in contact with, or is covered by the following metallic objects
 - Cards to which aluminum foil is attached
 - Cigarette boxes that have aluminum foil inside
 - Metallic wallets or bags
 - Coins
 - Hand warmers made of metal
 - Media such as CDs and DVDs
- When other wireless keys (that emit radio waves) are being used nearby
- When carrying the electronic key together with the following devices that emit radio waves
 - Portable radio, cellular phone, cordless phone or other wireless communication device
 - Another vehicle's electronic key or a wireless key that emits radio waves
 - Personal computers or personal digital assistants (PDAs)
 - Digital audio players
 - Portable game systems
- If window tint with a metallic content or metallic objects are attached to the rear window
- When the electronic key is placed near a battery charger or electronic devices

■ Notes for the entry function

- Even when the electronic key is within the effective range (detection areas), the system may not operate properly in the following cases:
 - The electronic key is too close to the window or outside door handle, near the ground, or in a high place when the doors are locked or unlocked.
 - The electronic key is on the instrument panel, luggage cover (if equipped) or floor, or in the door pockets, glove box, accessory box of the instrument panel, or in/near the front cup holder when the engine is started or engine switch modes are changed.
- Do not leave the electronic key on top of the instrument panel or near the door pockets when exiting the vehicle. Depending on the radio wave reception conditions, it may be detected by the antenna outside the cabin and the door will become lockable from the outside, possibly trapping the electronic key inside the vehicle.
- As long as the electronic key is within the effective range, the doors may be locked or unlocked by anyone.
- Even if the electronic key is not inside the vehicle, it may be possible to start the engine if the electronic key is near the window.
- The doors may unlock if a large amount of water splashes on the door handle, such as in the rain or in a car wash when the electronic key is within the effective range. (The door will automatically be locked after approximately 30 seconds if the doors are not opened and closed.)
- Gripping the door handle when wearing a glove may not unlock the door.
- If the wireless remote control is used to lock the doors when the electronic key is near the vehicle, there is a possibility that the door may not be unlocked by the entry function. (Use the wireless remote control to unlock the doors.)
- A sudden approach to the effective range or door handle may prevent the doors from being unlocked. In this case, return the door handle to the original position and check that the doors unlock before pulling the door handle again.

■ Notes for locking the doors

- Touching the door lock sensor while wearing gloves may delay or prevent lock operation. Remove the gloves and touch the lock sensor again.
- If the door handle becomes wet while the electronic key is within the effective range, the door may lock and unlock repeatedly. Place the key in a position 2 m (6 ft.) or more separate from the vehicle while the vehicle is being washed. (Take care to ensure that the key is not stolen.)
- If the electronic key is inside the vehicle and a door handle becomes wet during a car wash, a buzzer will sound outside the vehicle. To turn off the alarm, lock all the doors.
- The lock sensor may not work properly if it comes into contact with ice, snow, mud, etc. Clean the lock sensor and attempt to operate it again.

■ Notes for the unlocking function

- A sudden approach to the effective range of door handle may prevent the doors from being unlocked. In this case, return the door handle to the original position and check that the doors unlock before pulling the door handle again.
- Gripping the door handle when wearing a glove may not unlock the door. Remove the gloves and touch the sensor on the back of the handle again.
- If the door handle becomes wet while the electronic key is within the effective range, the door may lock and unlock repeatedly. Place the key in a position 2 m (6 ft.) or more separate from the vehicle while the vehicle is being washed. (Take care to ensure that the key is not stolen.)
- If there is another electronic key in the detection area, it may take slightly longer to unlock the doors after the door handle is gripped.

■ When the vehicle is not driven for extended periods

- To prevent theft of the vehicle, do not leave the electronic key within 2 m (6 ft.) of the vehicle.
- The smart entry & start system can be deactivated in advance. (→P. 489)

■ To operate the system properly

Make sure to carry the electronic key when operating the system. Do not get the electronic key too close to the vehicle when operating the system from the outside of the vehicle.

Depending on the position and holding condition of the electronic key, the key may not be detected correctly and the system may not operate properly. (The alarm may go off accidentally, or the door lock prevention function may not operate.)

■ If the smart entry & start system does not operate properly

- Locking and unlocking the doors: Use the mechanical key. (→P. 451)
- Starting the engine: →P. 451

■ Customization

Settings (e. g. smart entry & start system) can be changed.
(Customizable features: →P. 489)

■ If the smart entry & start system has been deactivated in a customized setting

- Locking and unlocking the doors:
Use the wireless remote control or mechanical key. (→P. 115, 451)
- Starting the engine and changing engine switch modes: →P. 451
- Stopping the engine: →P. 186

■ Certification for the smart entry & start system



The DECLARATION of CONFORMITY (DoC) is available at the following address:

<http://www.tokai-rika.co.jp/pc/>

<p>Hereby, TRCZ s.r.o., declares that this BA7EQ is in compliance with the essential requirements and other relevant provisions of Directive 1999/5/EC.</p>
<p>TRCZ s.r.o. vakuuttaa läten että BA7EQ tyypinen laite on direktiivin 1999/5/EY oleellisten vaatimusten ja siltä koskevien direktiivin muiden ehtojen mukainen.</p>
<p>Hierbij verklaart TRCZ s.r.o. dat het toestel BA7EQ in overeenstemming is met de essentiële eisen en de andere relevante bepalingen van richtlijn 1999/5/EG.</p>
<p>Par la présente TRCZ s.r.o. déclare que l'appareil BA7EQ est conforme aux exigences essentielles et aux autres dispositions pertinentes de la directive 1999/5/CE.</p>
<p>Härmed intygar TRCZ s.r.o. att denna BA7EQ står i överensstämmelse med de väsentliga egenskapskrav och övriga relevanta bestämmelser som framgår av direktiv 1999/5/EG.</p>
<p>Undertegnede TRCZ s.r.o. erklærer herved, at følgende udstyr BA7EQ overholder de væsentlige krav og øvrige relevante krav i direktiv 1999/5/EF.</p>
<p>Hiermit erklärt TRCZ s.r.o., dass sich das Gerät BA7EQ in Übereinstimmung mit den grundlegenden Anforderungen und den übrigen einschlägigen Bestimmungen der Richtlinie 1999/5/EG befindet.</p>
<p>ΜΕ ΤΗΝ ΠΑΡΟΥΣΙΑ ΤΡCΖ S.R.O. ΔΗΛΩΝΕΙ ΟΤΙ ΒΑ7ΕQ ΣΥΜΜΟΡΦΩΝΕΤΑΙ ΠΡΟΣ ΤΙΣ ΟΥΣΙΩΔΕΙΣ ΑΠΑΙΤΗΣΕΙΣ ΚΑΙ ΤΙΣ ΛΟΙΠΕΣ ΣΧΕΤΙΚΕΣ ΔΙΑΤΑΞΕΙΣ ΤΗΣ ΟΔΗΓΙΑΣ 1999/5/ΕΚ.</p>
<p>Con la presente TRCZ s.r.o. dichiara che questo BA7EQ è conforme ai requisiti essenziali ed alle altre disposizioni pertinenti stabilite dalla direttiva 1999/5/CE.</p>
<p>Por medio de la presente TRCZ s.r.o. declara que el BA7EQ cumple con los requisitos esenciales y cualesquiera otras disposiciones aplicables o exigibles de la Directiva 1999/5/CE.</p>
<p>TRCZ s.r.o. declara que este BA7EQ está conforme com os requisitos essenciais e outras disposições da Directiva 1999/5/CE.</p>
<p>Hawnhekk, TRCZ s.r.o., jiddikjara li dan BA7EQ jikkonforma mal-htigijiet essenzjali u ma provvedimenti oħrajn relevanti li hemm fid-Direttiva 1999/5/EC.</p>
<p>Käesolevaga kinnitab TRCZ s.r.o. seadme BA7EQ vastavust direktiivi 1999/5/EÜ põhinõuetele ja nimetatud direktiivist tulenevatele teistele asjakohastele sätetele.</p>
<p>Alulroolt, TRCZ s.r.o. nyilatkozum, hogy a BA7EQ megfelel a vonatkozó alapvető követelményeknek és az 1999/5/EC irányelv egyéb előírásainak.</p>
<p>TRCZ s.r.o. tímto vyhlasuje, že BA7EQ splňa základné požiadavky a všetky príslušné ustanovenia Smernice 1999/5/ES.</p>
<p>TRCZ s.r.o. tímto prohlašuje, že tento BA7EQ je ve shodě se základními požadavky a dalšími příslušnými ustanoveními směrnice 1999/5/ES.</p>
<p>TRCZ s.r.o. izjavlja, da je ta BA7EQ v skladu z bistvenimi zahtevami in ostalimi relevantnimi določili direktive 1999/5/ES.</p>
<p>Šiuo TRCZ s.r.o. deklaruoja, kad šis BA7EQ atitinka esminius reikalavimus ir kitas 1999/5/EB Direktivos nuostatas.</p>
<p>Ar šo TRCZ s.r.o. deklarē, ka BA7EQ atbilst Direktīvas 1999/5/EK būtiskajām prasībām un citiem ar to saistītajiem noteikumiem.</p>
<p>Niniejszym TRCZ s.r.o. oświadcza, że BA7EQ jest zgodny z zasadniczymi wymogami oraz pozostałymi stosownymi postanowieniami Dyrektywy 1999/5/EC.</p>
<p>Hér með lýsir TRCZ s.r.o. yfir því að BA7EQ er í samræmi við grunnkröfur og aðrar kröfur, sem gerðar eru í tilskipun 1999/5/EC.</p>
<p>TRCZ s.r.o. erklærer herved at udstyret BA7EQ er i samsvar med de grunnleggende krav og øvrige relevante krav i direktiv 1999/5/EF.</p>
<p>С настоящето, TRCZ s.r.o., декларира, че BA7EQ е в съответствие със съществените изисквания и другите приложими разпоредби на Директива 1999/5/EC.</p>
<p>Prin prezenta, TRCZ s.r.o., declară că aparatul BA7EQ este în conformitate cu cerințele esențiale și cu alte prevederi pertinente ale Directivei 1999/5/CE.</p>
<p>Ovim, TRCZ s.r.o., izjavljuje da ovaj BA7EQ je usklađen sa bitnim zahtjevima i drugim relevantnim odredbama Direktive 1999/5/EC.</p>
<p>Nepermjet kesaj, TRCZ s.r.o., deklaruj qe ky BA7EQ eshte ne pajtim me kerkesat thelbeseore dhe dispozitat e tjera perkatese te Direktives 1999/5/EC.</p>
<p>Ovim TRCZ s.r.o., izjavljuje da je BA7EQ u skladu s bitnim zahtjevima i drugim relevantnim odredbama Direktive 1999/5/EC i Pravilnika o RITT opremi (NN 25/2012).</p>
<p>Ovim, TRCZ s.r.o., deklariše da je BA7EQ u skladu sa osnovnim zahtjevima i ostalim relevantnim odredbama Direktive 1999/5/EC.</p>

<p>Hereby, TRCZ s.r.o., declares that this B94UM is in compliance with the essential requirements and other relevant provisions of Directive 1999/5/EC.</p>
<p>TRCZ s.r.o. vakuuttaa läten että B94UM tyyppinen laite on direktiivin 1999/5/EY oleellisten vaatimusten ja sitä koskevien direktiivin muiden ehtojen mukainen.</p>
<p>Hierbij verklaart TRCZ s.r.o. dat het toestel B94UM in overeenstemming is met de essentiële eisen en de andere relevante bepalingen van richtlijn 1999/5/EG.</p>
<p>Par la présente TRCZ s.r.o. déclare que l'appareil B94UM est conforme aux exigences essentielles et aux autres dispositions pertinentes de la directive 1999/5/CE.</p>
<p>Härmed intygar TRCZ s.r.o. att denna B94UM står i överensstämmelse med de väsentliga egenskapskrav och övriga relevanta bestämmelser som framgår av direktiv 1999/5/EG.</p>
<p>Undertegnede TRCZ s.r.o. erklærer herved, at følgende udstyr B94UM overholder de væsentlige krav og øvrige relevante krav i direktiv 1999/5/EF.</p>
<p>Hiermit erklärt TRCZ s.r.o., dass sich das Gerät B94UM in Übereinstimmung mit den grundlegenden Anforderungen und den übrigen einschlägigen Bestimmungen der Richtlinie 1999/5/EG befindet.</p>
<p>ΜΕ ΤΗΝ ΠΑΡΟΥΣΑ TRCZ s.r.o. ΔΗΛΩΝΕΙ ΟΤΙ Β94UM ΣΥΜΜΟΡΦΩΝΕΤΑΙ ΠΡΟΣ ΤΙΣ ΟΥΣΙΩΔΕΙΣ ΑΠΑΙΤΗΣΕΙΣ ΚΑΙ ΤΙΣ ΛΟΙΠΕΣ ΣΧΕΤΙΚΕΣ ΔΙΑΤΑΞΕΙΣ ΤΗΣ ΟΔΗΓΙΑΣ 1999/5/ΕΚ.</p>
<p>Con la presente TRCZ s.r.o. dichiara che questo B94UM è conforme ai requisiti essenziali ed alle altre disposizioni pertinenti stabilite dalla direttiva 1999/5/CE.</p>
<p>Por medio de la presente TRCZ s.r.o. declara que el B94UM cumple con los requisitos esenciales y cualesquiera otras disposiciones aplicables o exigibles de la Directiva 1999/5/CE.</p>
<p>TRCZ s.r.o. declara que este B94UM está conforme com os requisitos essenciais e outras disposições da Directiva 1999/5/CE.</p>
<p>Häwnhekk, TRCZ s.r.o., jiddikjara li dan B94UM jikkonforma mal-htigijiet essenzjali u ma provvedimenti oħrajn relevanti li hemm fid-Direttiva 1999/5/EC.</p>
<p>Käesolevaga kinnitab TRCZ s.r.o. seadme B94UM vastavust direktiivi 1999/5/EU põhinõuetele ja mis tahes muudele direktiivis tulenevatele teistele asjakohastele sätetele.</p>
<p>Álluliroit, TRCZ s.r.o. nyilatkozom, hogy a B94UM megfelel a vonatkozó alapvető követelményeknek és az 1999/5/EC irányelv egyéb előírásainak.</p>
<p>TRCZ s.r.o. týmto vyhlasuje, že B94UM spĺňa základné požiadavky a všetky príslušné ustanovenia Smernice 1999/5/ES.</p>
<p>TRCZ s.r.o. tímto prohlašuje, že tento B94UM je ve shodě se základními požadavky a dalšími příslušnými ustanoveními směrnice 1999/5/ES.</p>
<p>TRCZ s.r.o. izjavlja, da je ta B94UM v skladu z bistvenimi zahtevami in ostalimi relevantnimi določili direktive 1999/5/ES.</p>
<p>Šio TRCZ s.r.o. deklaruoja, kad šis B94UM atitinka esminius reikalavimus ir kitas 1999/5/EB Direktyvos nuostatas.</p>
<p>Ar šo TRCZ s.r.o. deklarē, ka B94UM atbilst Direktīvas 1999/5/EK būtiskajām prasībām un citiem ar to saistītajiem noteikumiem.</p>
<p>Niniejszym TRCZ s.r.o. oświadcza, że B94UM jest zgodny z zasadniczymi wymogami oraz pozostałymi stosownymi postanowieniami Dyrektywy 1999/5/EC.</p>
<p>Hér með lýsir TRCZ s.r.o. yfir því að B94UM er í samræmi við grunnkröfur og aðrar kröfur, sem gerðar eru í tilskipun 1999/5/EC.</p>
<p>TRCZ s.r.o. erklærer herved at udstyret B94UM er i samsvar med de grunnleggende krav og øvrige relevante krav i direktiv 1999/5/EF.</p>
<p>С настоящето, TRCZ s.r.o., декларира, че B94UM е в съответствие със съществените изисквания и другите приложими разпоредби на Директива 1999/5/EC.</p>
<p>Prin prezenta, TRCZ s.r.o., declară că aparatul B94UM este în conformitate cu cerințele esențiale și cu alte prevederi pertinente ale Directivei 1999/5/CE.</p>
<p>Ovim, TRCZ s.r.o., izjavjuje da ovaj B94UM je usklađen sa bitnim zahtjevima i drugim relevantnim odredbama Direktive 1999/5/EC.</p>
<p>Nepermjet kesaj, TRCZ s.r.o., deklaruj qe ky B94UM eshte ne pajtim me kerkesat thelbësore dhe dispozitat e tjera perkatese te Direktives 1999/5/EC.</p>
<p>Ovim TRCZ s.r.o., izjavjuje da je B94UM u skladu sa bitnim zahtjevima i drugim relevantnim odredbama Direktive 1999/5/EC i Pravilnika o RITT opremi (NN 25/2012).</p>
<p>Ovim, TRCZ s.r.o., deklarirše da je B94UM u skladu sa osnovnim zahtjevima i ostalim relevantnim odredbama Direktive 1999/5/EC.</p>

TOYOTA**TOYOTA MOTOR CORPORATION**

1, TOYOTA-CHO, TOYOTA, AICHI, 471-8571, JAPAN TEL: +81-565-28-2121

R&TTE Declaration of Conformity

We,

Manufacturer's Name: TOYOTA MOTOR CORPORATION

Manufacturer's Address: 1, Toyota -cho, Toyotz, Aichi, 471-8572, Japan

hereby declare under our sole responsibility that the product:

Product Name: LF Oscillator

Product Model: TMLF10-16

to which this declaration relates is in conformity with the essential requirements and other relevant requirements of the R&TTE Directive (1999/5/EC). The product is compliant with the following standards and/or other normative documents:

-Health & safety requirements:	EN 50950-1
-EMC requirements	EN 301 489-01 & EN 301 489-03
-Effective uses of radio spectrum:	EN 300 330-2

Supplementary information:

* CE mark	
* Member states Intended for use	EU and EFTA

Date: February 25, 2013

Signature: 
Tetsuya Matsuo

Hereby, Toyota Motor Corporation, declares that this TMLF10-16 is in compliance with the essential requirements and other relevant provisions of Directive 1999/5/EC.
Toyota Motor Corporation vakuuttaa läten että TMLF10-16 tyyppilinen laite on direktiivin 1999/5/EY oleellisten vaatimusten ja sitä koskevien direktiivin muiden ehtojen mukainen.
Hierbij verklaart Toyota Motor Corporation dat het toestel TMLF10-16 in overeenstemming is met de essentiële eisen en de andere relevante bepalingen van richtlijn 1999/5/EG.
Par la présente Toyota Motor Corporation déclare que l'appareil TMLF10-16 est conforme aux exigences essentielles et aux autres dispositions pertinentes de la directive 1999/5/CE.
Härmed intygar Toyota Motor Corporation att denna TMLF10-16 står i överensstämmelse med de väsentliga egenskapskrav och övriga relevanta bestämmelser som framgår av direktiv 1999/5/EG.
Undertegnede Toyota Motor Corporation erklærer herved, at følgende udstyr TMLF10-16 overholder de væsentlige krav og øvrige relevante krav i direktiv 1999/5/EF.
Hiermit erklart Toyota Motor Corporation, dass sich das Gerät TMLF10-16 in Übereinstimmung mit den grundlegenden Anforderungen und den übrigen einschlägigen Bestimmungen der Richtlinie 1999/5/EG befindet.
ΜΕ ΤΗΝ ΠΑΡΟΥΣΙΑ Toyota Motor Corporation ΔΗΛΩΝΕΙ ΟΤΙ ΤΜΛF10-16 ΣΥΜΜΟΡΦΩΝΕΤΑΙ ΠΡΟΣ ΤΙΣ ΟΥΣΙΩΔΕΙΣ ΑΠΑΙΤΗΣΕΙΣ ΚΑΙ ΤΙΣ ΛΟΙΠΕΣ ΣΧΕΤΙΚΕΣ ΔΙΑΤΑΞΕΙΣ ΤΗΣ ΟΔΗΓΙΑΣ 1999/5/ΕΚ.
Con la presente Toyota Motor Corporation dichiara che questo TMLF10-16 è conforme ai requisiti essenziali ed alle altre disposizioni pertinenti stabilite dalla direttiva 1999/5/CE.
Por medio de la presente Toyota Motor Corporation declara que el TMLF10-16 cumple con los requisitos esenciales y cualesquiera otras disposiciones aplicables o exigibles de la Directiva 1999/5/CE.
Toyota Motor Corporation declara que este TMLF10-16 está conforme com os requisitos essenciais e outras disposições da Directiva 1999/5/CE.
Hawnhekk, Toyota Motor Corporation, jiddikjara li dan TMLF10-16 jikkonforma mal-htigijiet essenzjali u ma provvedimenti oħrajn relevanti li hemm fid-Direttiva 1999/5/EC.
Käesolevaga kinnitab Toyota Motor Corporation seadme TMLF10-16 vastavust direktiivi 1999/5/EÜ põhinõuetele ja nimetatud direktiivist tulenevatele teistele asjakohastele sätetele.
Aluliltoit, Toyota Motor Corporation nyilatkozom, hogy a TMLF10-16 megfelel a vonatkozó alapvető követelményeknek és az 1999/5/EC irányelv egyéb előírásainak.
Toyota Motor Corporation týmto vyhlasuje, že TMLF10-16 spĺňa základné požiadavky a všetky príslušné ustanovenia Smernice 1999/5/ES.
Toyota Motor Corporation tímto prohlašuje, že tento TMLF10-16 je ve shodě se základními požadavky a dalšími příslušnými ustanoveními směrnice 1999/5/ES.
Toyota Motor Corporation izjavja, da je ta TMLF10-16 v skladu z bistvenimi zahtevami in ostalimi relevantnimi določili direktive 1999/5/ES.
Šiuo Toyota Motor Corporation deklaruoja, kad šis TMLF10-16 atitinka esminius reikalavimus ir kitas 1999/5/EB Direktyvos nuostatas.
Ar šo Toyota Motor Corporation deklarē, ka TMLF10-16 atbilst Direktīvas 1999/5/EK būtiskajām prasībām un citiem ar to saistītajiem noteikumiem.
Niniejszym Toyota Motor Corporation oświadcza, że TMLF10-16 jest zgodny z zasadniczymi wymogami oraz pozostałymi stosownymi postanowieniami Dyrektywy 1999/5/EC.
Hér með lýsir Toyota Motor Corporation yfir því að TMLF10-16 er í samræmi við grunnkröfur og aðrar kröfur, sem gerðar eru í tilskipun 1999/5/EC.
Toyota Motor Corporation erklærer herved at udstyret TMLF10-16 er i samsvær med de grunnleggende krav og øvrige relevante krav i direktiv 1999/5/EF.
С настоящим, Toyota Motor Corporation, декларира, че TMLF10-16 е в съответствие със съществените изисквания и другите приложими разпоредби на Директива 1999/5/EC.
Prin prezenta, Toyota Motor Corporation, declară că aparatul TMLF10-16 este în conformitate cu cerințele esențiale și cu alte prevederi pertinente ale Directivei 1999/5/CE.
Ovim, Toyota Motor Corporation, izjavljuje da ovaj TMLF10-16 je usklađen sa bitnim zahtjevima i drugim relevantnim odredbama Direktive 1999/5/EC.
Þessumtílið kesaj, Toyota Motor Corporation, deklaroj qe ky TMLF10-16 eshte ne pajtim me kerkesat thelbessore dhe dispozitat e tjera perkatese te Direktives 1999/5/EC.
Ovim Toyota Motor Corporation, izjavljuje da je TMLF10-16 u skladu s bitnim zahtjevima i drugim relevantnim odredbama Direktive 1999/5/EC i Pravilnika o RITD opremi (NN 25/2012).
Ovim, Toyota Motor Corporation, deklarirše da je TMLF10-16 u skladu sa osnovnim zahtjevima i ostalim relevantnim odredbama Direktive 1999/5/EC.

 **WARNING****■ Caution regarding interference with electronic devices**

- People with implantable cardiac pacemakers, cardiac resynchronization therapy-pacemakers or implantable cardioverter defibrillators should maintain a reasonable distance between themselves and the smart entry & start system antennas. (→P. 127)

The radio waves may affect the operation of such devices. If necessary, the entry function can be disabled. Ask any authorized Toyota dealer or repairer, or another duly qualified and equipped professional for details, such as the frequency of radio waves and timing of the emitted radio waves. Then, consult your doctor to see if you should disable the entry function.

- Users of any electrical medical device other than implantable cardiac pacemakers, cardiac resynchronization therapy-pacemakers or implantable cardioverter defibrillators should consult the manufacturer of the device for information about its operation under the influence of radio waves.

Radio waves could have unexpected effects on the operation of such medical devices.

Ask any authorized Toyota dealer or repairer, or another duly qualified and equipped professional for details on disabling the entry function.

Front seats

Adjustment procedure

- ① Seat position adjustment lever
- ② Seatback angle adjustment lever
- ③ Vertical height adjustment lever (if equipped)
- ④ Seatback lock release lever (3-door models only)

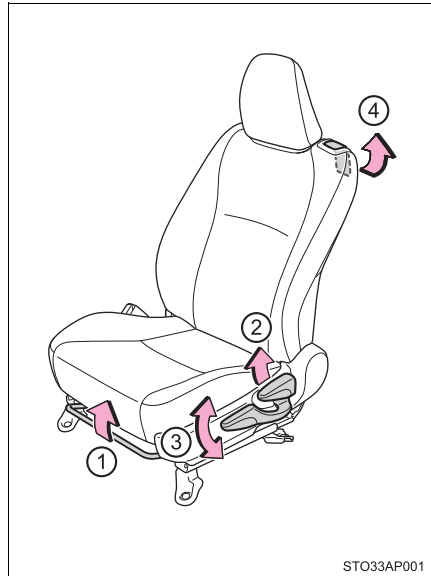

Moving front passenger's seat for rear seat entry (3-door models only)

■ Getting in the vehicle

For easy access to the rear seat, use the seatback lock release lever. When the seatback lock release lever is used, the seat's original slide position is memorized, so the seat may be returned to that original position. However, if the seatback angle adjustment lever is used, the seat will not return to its original position.

Lift the seatback lock release lever.

The seatback will fold forward, and the seat's slide lock will be released.

Move the seat all the way forward.

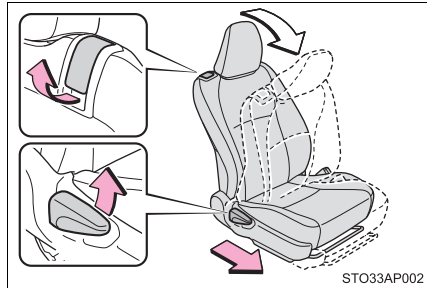

■ Getting out of the vehicle

Lift the seatback lock release lever or seatback angle adjustment lever.

The seatback will fold forward, and the seat's slide lock will be released.

Move the seat all the way forward.

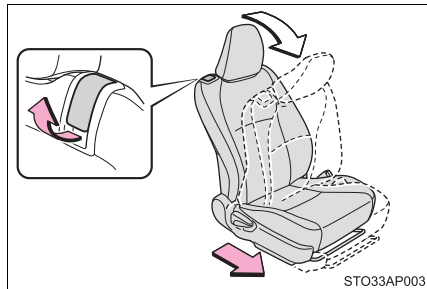

■ After passengers have entered the vehicle (3-door models only)

Slide the seat backward and then lift the seatback. The seat will be set and locked to its previous position automatically. If the seat cannot be slid back to the previous position due to the rear passenger or luggage, the seat will be locked in that position, disabling the seat position memory system.

To recall the previous position, lift the seatback lock release lever after removing the luggage, or after having the passenger get out or sit properly so that the seat can be slid back to the previous position. However, if you slide the seat further backwards than previous position using the seat position adjustment lever, the memory of previous position will be overwritten.

**WARNING****■ When adjusting the seat position**

- Take care when adjusting the seat position to ensure that other passengers are not injured by the moving seat.
- Do not put your hands under the seat or near the moving parts to avoid injury.
Fingers or hands may become jammed in the seat mechanism.

■ Seat adjustment

- Be careful that the seat does not hit passengers or luggage.
- To reduce the risk of sliding under the lap belt during a collision, do not recline the seat more than necessary.
If the seat is too reclined, the lap belt may slide past the hips and apply restraint forces directly to the abdomen, or your neck may contact the shoulder belt, increasing the risk of death or serious injury in the event of an accident.
Adjustments should not be made while driving as the seat may unexpectedly move and cause the driver to lose control of the vehicle.
- After adjusting the seat, make sure that the seat is locked in position.
- Never allow anyone to touch seatback lock release levers while the vehicle is moving.
- If anyone is in the vicinity, make sure they are clear of the seat back path and let them know that the seat is about to move.

■ After returning the seatback to the upright position

Make sure the seatback is securely locked by pushing it forward and rearward. Failure to do so may result in death or serious injury.

Rear seats*

The seatbacks of the rear seats can be folded down.

Folding down the rear seatbacks

- 1 Stow the rear seat belt buckles as shown.

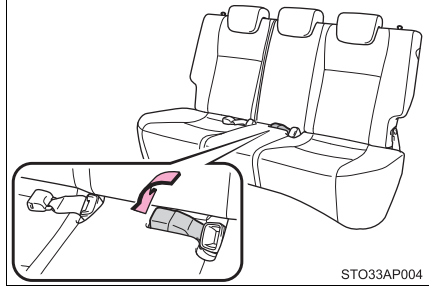

- 2 Stow the seat belts.

Center: →P. 32

Outside: Use the seat belt hangers to prevent the belts from being tangled.

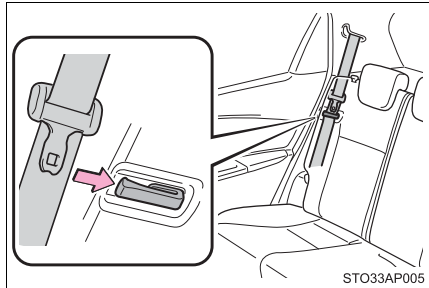

- 3 Lower the head restraints to the lowest position.

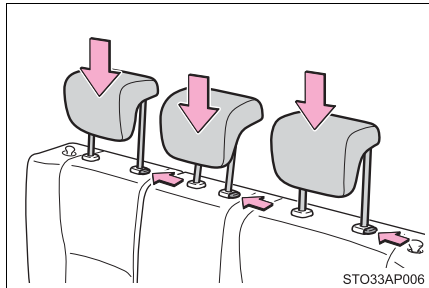

- 4 Pull the seatback lock release knob and fold the seatback down.

Each seatback may be folded separately.

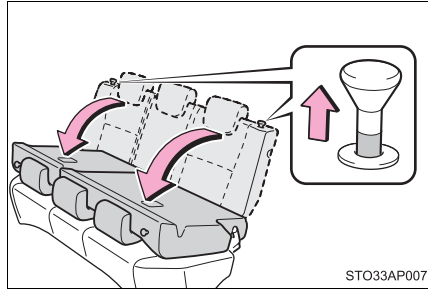

STO33AP007

WARNING

■ When folding the rear seatbacks down

Observe the following precautions. Failure to do so may result in death or serious injury.

- Do not fold the seatbacks down while driving.
- Stop the vehicle on level ground, set the parking brake and shift the shift lever to P (Multidrive) or N (manual transmission).
- Do not allow anyone to sit on a folded seatback or in the luggage compartment while driving.
- Do not allow children to enter the luggage compartment.
- Do not allow anyone to sit on the rear center seat if the rear right seat is folded down, as the seat belt buckle for the rear center seat belt is then concealed under the folded seat and cannot be used.
- Be careful not to catch your hand when folding the rear seatbacks.
- Depending on the position of the front seat, it may interfere when trying to fold down the rear seatbacks. If this happens, adjust the position of the front seat.

⚠ WARNING**■ After returning the rear seatback to the upright position**

Observe the following precautions. Failure to do so may result in death or serious injury.

- Make sure that the seatback is securely locked in position by lightly pushing it back and forth.
If the seatback is not securely locked, the red marking will be visible on the seatback lock release knob. Make sure that the red marking is not visible.

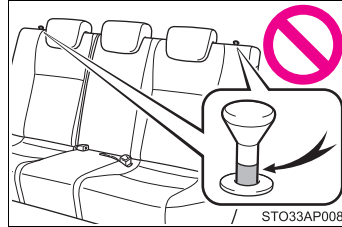

- Check that the seat belts are not twisted or caught in the seatback.

⚠ NOTICE**■ Stowing the seat belts**

The seat belts and the buckles must be stowed before you fold down the rear seatbacks.

Head restraints

Head restraints are provided for all seats.

Adjusting the head restraints

① Up

Pull the head restraints up.

② Down

Push the head restraint down while pressing the lock release button.

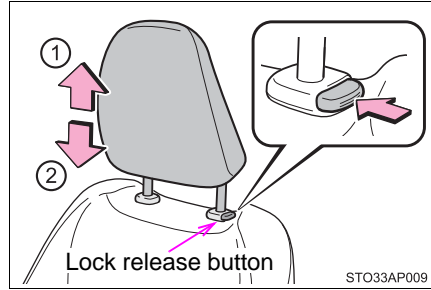

■ Removing the front seats and rear center seat head restraints

Pull the head restraint up while pressing the lock release button.

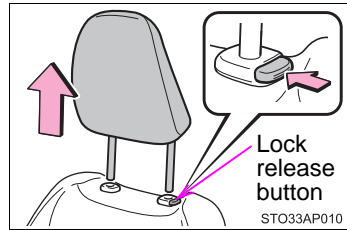

■ Removing the rear center seats head restraints

- 1 Pull the lock release knob and fold down the seatback until it reaches the position where the head restraints can be removed.

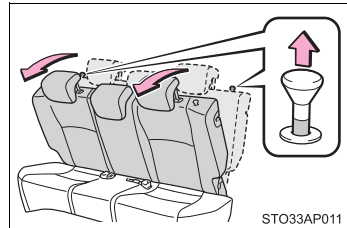

- 2 Pull the head restraint up while pushing the lock release button.

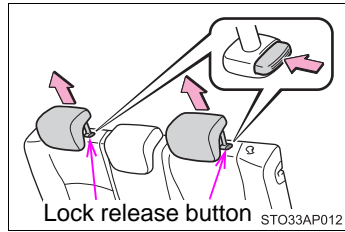

■ Adjusting the height of the head restraints

Make sure that the head restraints are adjusted so that the center of the head restraint is closest to the top of your ears.

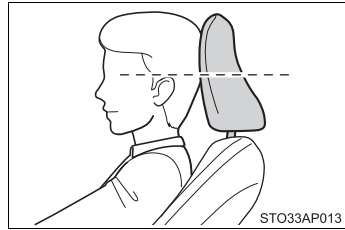

■ Adjusting the rear seat head restraints

Always raise the head restraint one level from the stowed position when in use.

⚠ WARNING

■ Head restraint precautions

Observe the following precautions regarding the head restraints. Failure to do so may result in death or serious injury.

- Use the head restraints designed for each respective seat.
- Adjust the head restraints to the correct position at all times.
- After adjusting the head restraints, push down on them and make sure they are locked in position.
- Do not drive with the head restraints removed.

Steering wheel

Adjustment procedure

- 1 Hold the steering wheel and push the lever down.

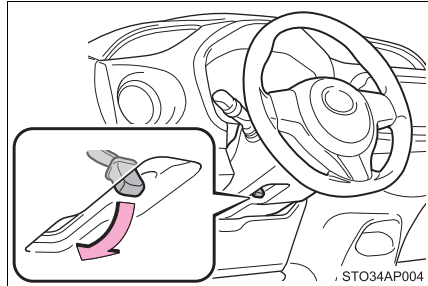

- 2 Adjust to the ideal position by moving the steering wheel horizontally and vertically.

After adjustment, pull the lever up to secure the steering wheel.

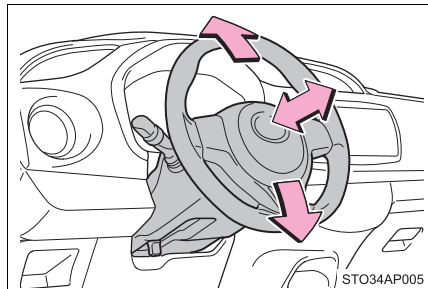

Horn

To sound the horn, press on or close to the  mark.

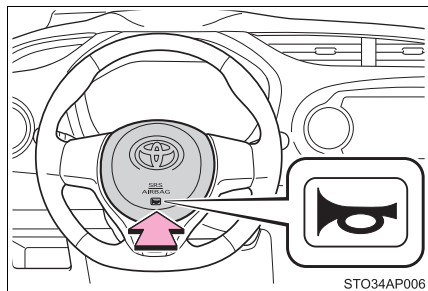

 **WARNING****■ Caution while driving**

Do not adjust the steering wheel while driving.

Doing so may cause the driver to mishandle the vehicle and cause an accident, resulting in death or serious injury.

■ After adjusting the steering wheel

Make sure that the steering wheel is securely locked.

Otherwise, the steering wheel may move suddenly, possibly causing an accident and resulting in death or serious injury.

Inside rear view mirror

The rear view mirror's position can be adjusted to enable sufficient confirmation of the rear view.

Adjusting the height of rear view mirror (vehicles with an auto anti-glare inside rear view mirror)

The height of the rear view mirror can be adjusted to suit your driving posture.

Adjust the height of the rear view mirror by moving it up and down.

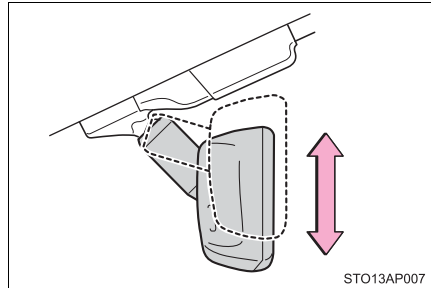

Anti-glare function

- ▶ Vehicles with a manual anti-glare inside rear view mirror

Reflected light from the headlamps of vehicles behind can be reduced by operating the lever.

- ① Normal position
- ② Anti-glare position

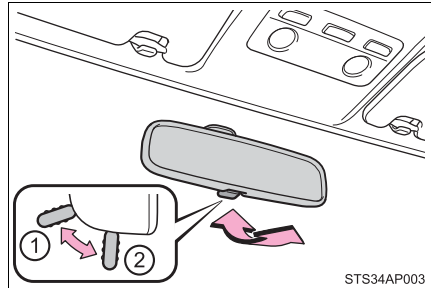

- ▶ Vehicles with an auto anti-glare inside rear view mirror

Responding to the level of brightness of the headlights of vehicles behind, the reflected light is automatically reduced.

Changing automatic anti-glare function mode

ON/OFF

When the automatic anti-glare function is in ON mode, the indicator illuminates.

Vehicles without a smart entry & start system:

The function will set to ON mode each time the engine switch is turned to the "ON" position. Pressing the button turns the function to OFF mode. (The indicator also turns off.)

Vehicles with a smart entry & start system:

The function will set to ON mode each time the engine switch is turned to IGNITION ON mode. Pressing the button turns the function to OFF mode. (The indicator also turns off.)

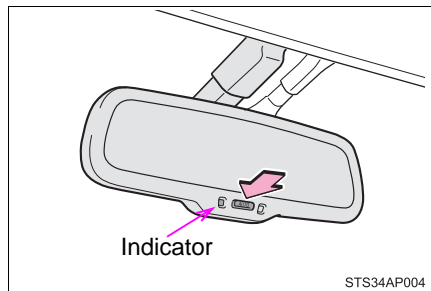

■ **To prevent sensor error (vehicles with an auto anti-glare inside rear view mirror)**

To ensure that the sensors operate properly, do not touch or cover them.

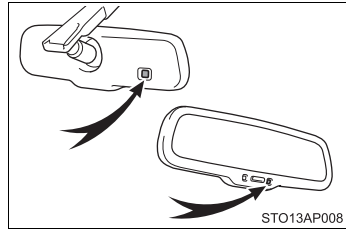

⚠ WARNING

■ **Caution while driving**

Do not adjust the position of the mirror while driving. Doing so may lead to mishandling of the vehicle and cause an accident, resulting in death or serious injury.

Outside rear view mirrors

Adjustment procedure

► Manually-adjustable type

Adjust the mirror up, down, in or out by pushing the mirror surface.

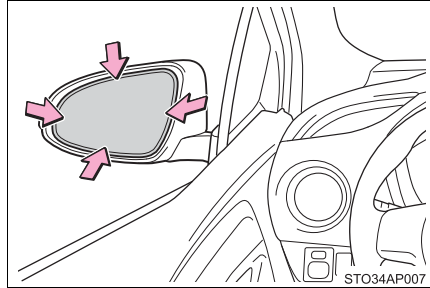

► Power-adjustable type

- 1 To select a mirror to adjust, press the switch.

- ① Left
- ② Right

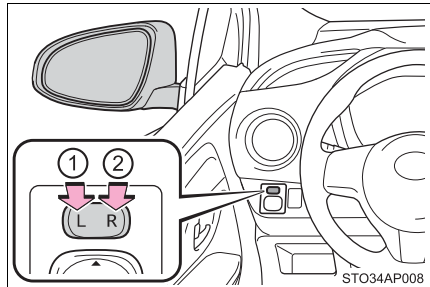

- 2 To adjust the mirror, press the switch.

- ① Up
- ② Right
- ③ Down
- ④ Left

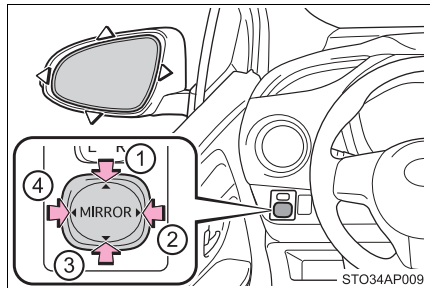

Folding the mirrors

▶ Manual type

Push the mirror back in the direction of the vehicle's rear.

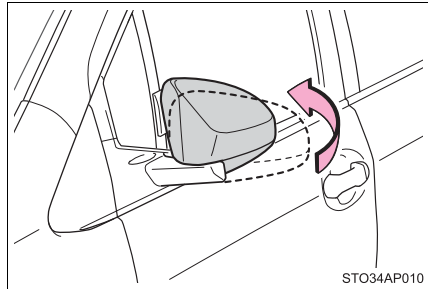

▶ Power type

Press the button to fold back the mirrors

Push once more to return to the original position.

The outside rear view mirrors will be folded or extended automatically, linked with the door locking or unlocking operations.

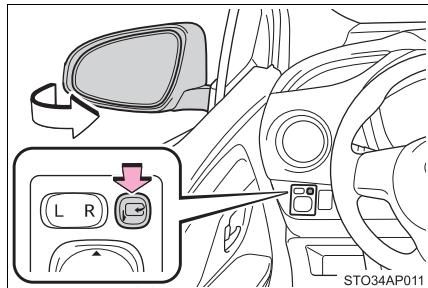

■ Mirror angle can be adjusted when (power-adjustable type)

▶ Vehicles without a smart entry & start system

The engine switch is in the "ACC" or "ON" position.

▶ Vehicles with a smart entry & start system

The engine switch is in ACCESSORY or IGNITION ON mode.

■ When the mirrors are fogged up (vehicles with outside rear view mirror defoggers)

The outside rear view mirrors can be cleared using the mirror defoggers. Turn on the rear window defogger to turn on the outside rear view mirror defoggers. (→P. 283, 291)

 **WARNING****■ Important points while driving**

Observe the following precautions while driving.

Failure to do so may result in loss of control of the vehicle and cause an accident, resulting in death or serious injury.

- Do not adjust the mirrors while driving.
- Do not drive with the mirrors folded.
- Both the driver and passenger side mirrors must be extended and properly adjusted before driving.

■ When a mirror is moving (power-adjustable type)

To avoid personal injury and mirror malfunction, be careful not to get your hand caught by the moving mirror.

■ When the mirror defoggers are operating (vehicles with outside rear view mirror defoggers)

Do not touch the rear view mirror surfaces, as they can become very hot and burn you.

Power windows

Opening and closing procedures

The power windows can be opened and closed using the switches.

Operating the switch moves the windows as follows:

- ① Closing
- ② One-touch closing (driver's window only)*
- ③ Opening
- ④ One-touch opening (driver's window only)*

*: To stop the window partway, operate the switch in the opposite direction.

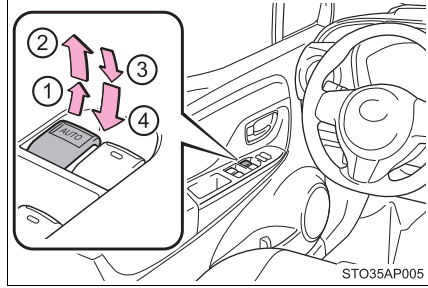

Window lock switch

Press the switch down to lock the passenger window switches.

Use this switch to prevent children from accidentally opening or closing a passenger window.

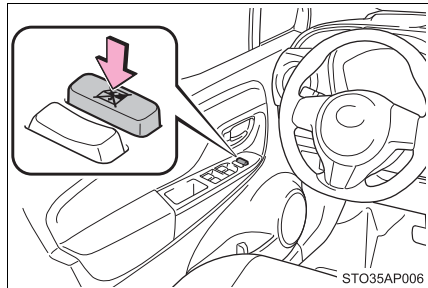

■ The power windows can be operated when

- ▶ Vehicles without a smart entry & start system

The engine switch is in the "ON" position.

- ▶ Vehicles with a smart entry & start system

The engine switch is in IGNITION ON mode.

■ Operating the power windows after turning the engine off

- ▶ Vehicles without a smart entry & start system

The power windows can be operated for approximately 45 seconds even after the engine switch is turned to the "ACC" or "LOCK" position. They cannot, however, be operated once either front door is opened.

- ▶ Vehicles with a smart entry & start system

The power windows can be operated for approximately 45 seconds even after the engine switch is turned to ACCESSORY mode or turned off. They cannot, however, be operated once either front door is opened.

■ Jam protection function (driver's window only)

If an object becomes caught between the window and the window frame, window travel is stopped and the window is opened slightly.

■ When the power window does not close normally

If the jam protection function is operating abnormally and a window cannot be closed, perform the following operations using the power window switch on the driver's door.

- After stopping the vehicle, the window can be closed by holding the power window switch in the one-touch closing position while the engine switch is turned to the "ON" position (vehicles without a smart entry & start system) or IGNITION ON mode (vehicles with a smart entry & start system).
- If the window still cannot be closed even by carrying out the operation as explained above, initialize the function by performing the following procedure.
 - 1 Hold the power window switch in the one-touch closing position. Continue holding the switch for a further 6 seconds after the window has closed.
 - 2 Hold the power window switch in the one-touch opening position. Continue holding the switch for a further 2 seconds after the window has opened completely.
 - 3 Hold the power window switch in the one-touch closing position once again. Continue holding the switch for a further 2 seconds after the window has closed.

If you release the switch while the window is moving, start again from the beginning.

If the window continues to close but then re-open slightly even after performing the above procedure correctly, have the vehicle inspected by any authorized Toyota dealer or repairer, or another duly qualified and equipped professional.

 **WARNING**

Observe the following precautions.
Failure to do so may result in death or serious injury.

■ Closing the windows

- The driver is responsible for all the power window operations, including the operation for the passengers. In order to prevent accidental operation, especially by a child, do not let a child operate the power windows. It is possible for children and other passengers to have body parts caught in the power window. Also, when riding with a child, it is recommended to use the window lock switch. (→P. 154)
- Check to make sure that all passengers do not have any part of their body in a position where it could be caught when a window is being operated.
- When exiting the vehicle, turn the engine switch off, carry the key and exit the vehicle along with the child. There may be accidental operation, due to mischief, etc., that may possibly lead to an accident.

■ Jam protection function (driver's window only)

- Never use any part of your body to intentionally activate the jam protection function.
- The jam protection function may not work if something gets caught just before the window fully closes.

Driving **4**

- 4-1. Before driving**
 - Driving the vehicle 160
 - Cargo and luggage 171
 - Trailer towing 173
- 4-2. Driving procedures**
 - Engine (ignition) switch
(vehicles without
a smart entry &
start system) 182
 - Engine (ignition) switch
(vehicles with
a smart entry &
start system) 185
 - Multidrive 191
 - Manual transmission 196
 - Turn signal lever 200
 - Parking brake 201
- 4-3. Operating the lights
and wipers**
 - Headlight switch 202
 - Fog light switch 208
 - Windshield wiper and
washer 210
 - Rear window wiper and
washer 214
- 4-4. Refueling**
 - Opening the fuel tank
cap 216
- 4-5. Using the driving support
systems**
 - Cruise control 220
 - Speed limiter 224
 - Stop & start system 228
 - Driving assist systems 235
 - Diesel particulate filter
system 240
- 4-6. Driving tips**
 - Winter driving tips 242

Driving the vehicle

The following procedures should be observed to ensure safe driving:

Starting the engine

→P. 182, 185

Driving

▶ Vehicles with a Multidrive

- 1 With the brake pedal depressed, shift the shift lever to D.
(→P. 191)
- 2 Release the parking brake. (→P. 201)
- 3 Gradually release the brake pedal and gently depress the accelerator pedal to accelerate the vehicle.

▶ Vehicles with a manual transmission

- 1 While depressing the clutch pedal, shift the shift lever to 1.
(→P. 196)
- 2 Release the parking brake. (→P. 201)
- 3 Gradually release the clutch pedal. At the same time, gently depress the accelerator pedal to accelerate the vehicle.

Stopping

► Vehicles with a Multidrive

- 1 With the shift lever in D, depress the brake pedal.

Vehicles with a Stop & Start system: If the Stop & Start system is enabled, depressing the brake pedal will stop the engine. (→P. 228)

- 2 If necessary, set the parking brake.

If the vehicle is to be stopped for an extended period of time, shift the shift lever to P. (→P. 191)

► Vehicles with a manual transmission

- 1 While depressing the clutch pedal, depress the brake pedal.

- 2 If necessary, set the parking brake.

If the vehicle is to be stopped for an extended period of time, shift the shift lever to N. (→P. 196)

Vehicles with a Stop & Start system: If the Stop & Start system is enabled, shifting the shift lever to N and releasing the clutch pedal will stop the engine. (→P. 228)

Parking the vehicle

► Vehicles with a Multidrive

- 1 With the shift lever in D, depress the brake pedal.

- 2 Set the parking brake. (→P. 201)

- 3 Shift the shift lever to P. (→P. 191)

If parking on a hill, block the wheels as needed.

- 4 Vehicles without a smart entry & start system: Turn the engine switch to the "LOCK" position to stop the engine.

Vehicles with a smart entry & start system: Press the engine switch to stop the engine.

- 5 Lock the door, making sure that you have the electronic key on your person.

► Vehicles with a manual transmission

- 1 While depressing the clutch pedal, depress the brake pedal.
- 2 Set the parking brake. (→P. 201)
- 3 Shift the shift lever to N. (→P. 196)

If parking on a hill, shift the shift lever to 1 or R and block the wheels as needed.

- 4 Vehicles without a smart entry & start system: Turn the engine switch to the "LOCK" position to stop the engine.

Vehicles with a smart entry & start system: Press the engine switch to stop the engine.

- 5 Lock the door, making sure that you have the key on your person.

Starting off on a steep uphill

► Vehicles with a Multidrive

- 1 Firmly set the parking brake with the brake pedal depressed, and then shift the shift lever to D.
- 2 Release the brake pedal and gently depress the accelerator pedal.
- 3 Release the parking brake.

► Vehicles with a manual transmission

- 1 With the parking brake firmly set and the clutch pedal fully depressed, shift the shift lever to 1.
- 2 Lightly depress the accelerator pedal at the same time as gradually releasing the clutch pedal.
- 3 Release the parking brake.

■ Driving in the rain

- Drive carefully when it is raining, because visibility will be reduced, the windows may become fogged-up, and the road will be slippery.
- Drive carefully when it starts to rain, because the road surface will be especially slippery.
- Refrain from high speeds when driving on an expressway in the rain, because there may be a layer of water between the tires and the road surface, preventing the steering and brakes from operating properly.

■ Engine speed while driving (vehicles with a Multidrive)

In the following conditions, the engine speed may become high while driving. This is due to automatic up-shifting control or down-shifting implementation to meet driving conditions. It does not indicate sudden acceleration.

- The vehicle is judged to be driving uphill or downhill
- When the accelerator pedal is released
- When the brake pedal is depressed while sport mode is selected

■ Breaking in your new Toyota

To extend the life of the vehicle, observing the following precautions is recommended:

- For the first 300 km (186 miles):
Avoid sudden stops.
- For the first 800 km (500 miles):
Do not tow a trailer.
- For the first 1000 km (621 miles):
 - Do not drive at extremely high speeds.
 - Avoid sudden acceleration.
 - Do not drive continuously in low gears.
 - Do not drive at a constant speed for extended periods.

■ Idling time before stopping the diesel engine

To prevent damage to the turbocharger, allow the engine to idle immediately after high-speed driving or driving up a hill.

Driving condition		Idling time
Normal city driving		Not necessary
High-speed driving	Constant speed of approximately 80 km/h (50 mph)	Approximately 20 seconds
	Constant speed of approximately 100 km/h (63 mph)	Approximately 1 minute
Steep hill driving or continuous driving at 100 km/h (63 mph) or more (race track driving etc.)		Approximately 2 minutes

■ Eco-friendly driving (vehicles with a Multidrive)

During Eco-friendly acceleration operation (Eco driving), Eco Driving Indicator Light will turn on. When the accelerator pedal is depressed excessively, and when the vehicle is stopped, the light turns off.

Eco Driving Indicator Light will not operate in the following conditions:

- The shift lever is in anything other than D.
- The driving mode is set to sport mode.
- The paddle shift switch is operated while the shift lever in D.
- The vehicle speed is approximately 130 km/h (80 mph) or higher.

Eco Driving Indicator Light can be activated or deactivated. (→P. 93)

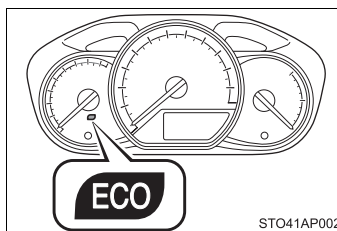

STO41AP002

■ Operating your vehicle in a foreign country

Comply with the relevant vehicle registration laws and confirm the availability of the correct fuel. (→P. 487)

 **WARNING**

Observe the following precautions.
Failure to do so may result in death or serious injury.

■ When starting the vehicle

On vehicles with a Multidrive, always keep your foot on the brake pedal while stopped with the engine running. This prevents the vehicle from creeping.

■ When driving the vehicle

- Do not drive if you are unfamiliar with the location of the brake and accelerator pedals to avoid depressing the wrong pedal.
 - Accidentally depressing the accelerator pedal instead of the brake pedal will result in sudden acceleration that may lead to an accident.
 - When backing up, you may twist your body around, leading to difficulty in operating the pedals. Make sure to operate the pedals properly.
 - Make sure to keep a correct driving posture even when moving the vehicle only slightly. This allows you to depress the brake and accelerator pedals properly.
 - Depress the brake pedal using your right foot. Depressing the brake pedal using your left foot may delay response in an emergency, resulting in an accident.
- Do not drive the vehicle over or stop the vehicle near flammable materials. The exhaust system and exhaust gases can be extremely hot. These hot parts may cause a fire if there is any flammable material nearby.
- During normal driving, do not turn off the engine. Turning the engine off while driving will not cause loss of steering or braking control, but the power assist to these systems will be lost. This will make it more difficult to steer and brake, so you should pull over and stop the vehicle as soon as it is safe to do so.
However, in the event of an emergency, such as if it becomes impossible to stop the vehicle in the normal way: →P. 395
- Use engine braking (downshift) to maintain a safe speed when driving down a steep hill.
Using the brakes continuously may cause the brakes to overheat and lose effectiveness. (→P. 191, 196)
- Do not adjust the positions of the steering wheel, the seat, or the inside or outside rear view mirrors while driving.
Doing so may result in a loss of vehicle control.
- Always check that all passengers' arms, heads or other parts of their body are not outside the vehicle.

 **WARNING**

Observe the following precautions.

Failure to do so may result in death or serious injury.

■ **When driving on slippery road surfaces**

- Sudden braking, acceleration and steering may cause tire slippage and reduce your ability to control the vehicle.
- Sudden acceleration, engine braking due to shifting, or changes in engine speed could cause the vehicle to skid.
- After driving through a puddle, depress the brake pedal to make sure that the brakes are functioning properly. Wet brake pads may prevent the brakes from functioning properly. If the brakes on only one side are wet and not functioning properly, steering control may be affected.

■ **When shifting the shift lever**

- On vehicles with a Multidrive, do not let the vehicle roll backward while the shift lever is in a driving position, or roll forward while the shift lever is in R. Doing so may cause the engine to stall or lead to poor brake and steering performance, resulting in an accident or damage to the vehicle.
- On vehicles with a Multidrive, do not shift the shift lever to P while the vehicle is moving.
Doing so can damage the transmission and may result in a loss of vehicle control.
- Do not shift the shift lever to R while the vehicle is moving forward.
Doing so can damage the transmission and may result in a loss of vehicle control.
- Do not shift the shift lever to D (Multidrive) or 1 (manual transmission) while the vehicle is moving backward.
Doing so can damage the transmission and may result in a loss of vehicle control.
- Shifting the shift lever to N while the vehicle is moving will disengage the engine from the transmission. Engine braking is not available when N is selected.
- On vehicles with a Multidrive, be careful not to shift the shift lever with the accelerator pedal depressed. Shifting the shift lever to a gear other than P or N may lead to unexpected rapid acceleration of the vehicle that may cause an accident and result in death or serious injury.

 **WARNING****■ If you hear a squealing or scraping noise (brake pad wear indicators)**

Have the brake pads checked and replaced by any authorized Toyota dealer or repairer, or another duly qualified and equipped professional as soon as possible.

Rotor damage may result if the pads are not replaced when needed.

It is dangerous to drive the vehicle when the wear limits of the brake pads and/or those of the brake discs are exceeded.

■ When the vehicle is stopped

- Do not race the engine.

If the vehicle is in any gear other than P (Multidrive) or N, the vehicle may accelerate suddenly and unexpectedly, causing an accident.

- On vehicles with a Multidrive, in order to prevent accidents due to the vehicle rolling away, always keep depressing the brake pedal while the engine is running, and apply the parking brake as necessary.

- If the vehicle is stopped on an incline, in order to prevent accidents caused by the vehicle rolling forward or backward, always depress the brake pedal and securely apply the parking brake as needed.

- Avoid revving or racing the engine.

Running the engine at high speed while the vehicle is stopped may cause the exhaust system to overheat, which could result in a fire if combustible material is nearby.

■ When the vehicle is parked

- Do not leave glasses, cigarette lighters, spray cans, or soft drink cans in the vehicle when it is in the sun.

Doing so may result in the following:

- Gas may leak from a cigarette lighter or spray can, and may lead to a fire.
- The temperature inside the vehicle may cause the plastic lenses and plastic material of glasses to deform or crack.
- Soft drink cans may rupture, causing the contents to spray over the interior of the vehicle, and may also cause a short circuit in the vehicle's electrical components.
- Do not leave cigarette lighters in the vehicle. If a cigarette lighter is in a place such as the glove box or on the floor, it may be lit accidentally when luggage is loaded or the seat is adjusted, causing a fire.

**WARNING**

- Do not attach adhesive discs to the windshield or windows. Do not place containers such as air fresheners on the instrument panel or dashboard. Adhesive discs or containers may act as lenses, causing a fire in the vehicle.
- Do not leave a door or window open if the curved glass is coated with a metallized film such as a silver-colored one. Reflected sunlight may cause the glass to act as a lens, causing a fire.
- On vehicles with a Multidrive, always apply the parking brake, shift the shift lever to P, stop the engine and lock the vehicle.
Do not leave the vehicle unattended while the engine is running.
- Do not touch the exhaust pipes while the engine is running or immediately after turning the engine off.
Doing so may cause burns.

■ When taking a nap in the vehicle

Always turn the engine off. Otherwise, if you accidentally move the shift lever or depress the accelerator pedal, this could cause an accident or fire due to engine overheating. Additionally, if the vehicle is parked in a poorly ventilated area, exhaust gases may collect and enter the vehicle, leading to death or a serious health hazard.

■ When braking

- When the brakes are wet, drive more cautiously.
Braking distance increases when the brakes are wet, and this may cause one side of the vehicle to brake differently than the other side. Also, the parking brake may not securely hold the vehicle.
- If the power brake assist function does not operate, do not follow other vehicles closely and avoid hills or sharp turns that require braking.
In this case, braking is still possible, but the brake pedal should be depressed more firmly than usual. Also, the braking distance will increase. Have your brakes fixed immediately.
- Do not pump the brake pedal if the engine stalls.
Each push on the brake pedal uses up the reserve for the power-assisted brakes.
- The brake system consists of 2 individual hydraulic systems; if one of the systems fails, the other will still operate. In this case, the brake pedal should be depressed more firmly than usual and the braking distance will increase.
Have your brakes fixed immediately.

 NOTICE**■ When driving the vehicle**

▶ Vehicles with a Multidrive

- Do not depress the accelerator and brake pedals at the same time during driving, as this may restrain the engine output.
- Do not use the accelerator pedal or depress the accelerator and brake pedals at the same time to hold the vehicle on a hill.

▶ Vehicles with a manual transmission

- Do not depress the accelerator and brake pedals at the same time during driving, as this may restrain the engine output.
- Do not shift gears unless the clutch pedal is fully depressed. After shifting, do not release the clutch pedal abruptly. Doing so may damage the clutch, transmission and gears.
- Observe the following to prevent the clutch from being damaged.
 - Do not rest your foot on the clutch pedal while driving.
Doing so may cause clutch trouble.
 - Do not use any gear other than the 1st gear when starting off and moving forward.
Doing so may damage the clutch.
 - Do not use the clutch to hold the vehicle when stopping on an uphill grade.
Doing so may damage the clutch.
- Do not shift the shift lever to R when the vehicle is still moving. Doing so may damage the clutch, transmission and gears.

■ When parking the vehicle (vehicles with a Multidrive)

Always shift the shift lever to P. Failure to do so may cause the vehicle to move or the vehicle may accelerate suddenly if the accelerator pedal is accidentally depressed.

**NOTICE****■ Avoiding damage to vehicle parts**

- Do not turn the steering wheel fully in either direction and hold it there for an extended period of time.
Doing so may damage the power steering motor.
- When driving over bumps in the road, drive as slowly as possible to avoid damaging the wheels, underside of the vehicle, etc.
- Diesel engine only: Make sure to idle the engine immediately after high-speed driving or hill climbing. Stop the engine only after the turbocharger has cooled down.
Failure to do so may cause damage to the turbocharger.

■ If you get a flat tire while driving

A flat or damaged tire may cause the following situations. Hold the steering wheel firmly and gradually depress the brake pedal to slow down the vehicle.

- It may be difficult to control your vehicle.
- The vehicle will make abnormal sounds or vibrations.
- The vehicle will lean abnormally.

Information on what to do in case of a flat tire (→P. 418)

■ When encountering flooded roads

Do not drive on a road that has flooded after heavy rain, etc. Doing so may cause the following serious damage to the vehicle:

- Engine stalling
- Short in electrical components
- Engine damage caused by water immersion

In the event that you drive on a flooded road and the vehicle is flooded, be sure to have any authorized Toyota dealer or repairer or another duly qualified and equipped professional check the following:

- Brake function
- Changes in quantity and quality of engine oil and transaxle fluid, etc.
- Lubricant condition for the bearings and suspension joints (where possible), and the function of all joints, bearings, etc.

Cargo and luggage

Take notice of the following information about storage precautions, cargo capacity and load:

WARNING

■ Things that must not be carried in the luggage compartment

The following things may cause a fire if loaded in the luggage compartment:

- Receptacles containing gasoline
- Aerosol cans

■ Storage precautions

Observe the following precautions.

Failure to do so may prevent the pedals from being depressed properly, may block the driver's vision, or may result in items hitting the driver or passengers, possibly causing an accident.

- Stow cargo and luggage in the luggage compartment whenever possible.
- Do not stack anything in the luggage compartment higher than the seat-backs.
- Do not place cargo or luggage in or on the following locations:
 - At the feet of the driver
 - On the front passenger or rear seats (when stacking items)
 - On the luggage cover
 - On the instrument panel
 - On the dashboard
- Secure all items in the occupant compartment.
- Vehicles with rear seats: When you fold down the rear seats, long items should not be placed directly behind the front seats.
- Never allow anyone to ride in the luggage compartment. It is not designed for passengers. They should ride in their seats with their seat belts properly fastened. Otherwise, they are much more likely to suffer death or serious bodily injury, in the event of sudden braking, sudden swerving or an accident.

**WARNING****■ Load and distribution**

- Do not overload your vehicle.
- Do not apply loads unevenly.
Improper loading may cause deterioration of steering or braking control which may cause death or serious injury.

Trailer towing

Your vehicle is designed primarily as a passenger carrying vehicle. Towing a trailer will have an adverse effect on handling, performance, braking, durability, and fuel consumption. Your safety and satisfaction depend on the proper use of correct equipment and cautions driving habits. For your safety and the safety of others, do not overload the vehicle or trailer.

To tow a trailer safely, use extreme care and drive the vehicle in accordance with the trailer's characteristics and operating conditions.

Toyota warranties do not apply to damage or malfunction caused by towing a trailer for commercial purposes.

Ask your local authorized Toyota dealer or repairer, or another duly qualified and equipped professional, for further details before towing, as there are additional legal requirements in some countries.

◆ **Weight limits**

Check the allowable towing capacity, GVM (Gross Vehicle Mass), MPAC (Maximum Permissible Axle Capacity), and permissible drawbar load before towing. (→P. 468)

◆ **Towing hitch/bracket**

Toyota recommends the use of the Toyota hitch/bracket for your vehicle. Other products of a suitable nature and comparable quality may also be used.

Important points regarding trailer loads

■ Total trailer weight and permissible drawbar load

① Total trailer weight

Weight of the trailer itself plus the trailer load should be within the maximum towing capacity. Exceeding this weight is dangerous.

(→P. 468)

When towing a trailer, use a friction coupler or friction stabilizer (sway control device).

② Permissible drawbar load

Allocate the trailer load so that the drawbar load is greater than 25 kg (55.1 lb.) or 4% of the towing capacity. Do not let the drawbar load exceed the indicated weight. (→P. 468)

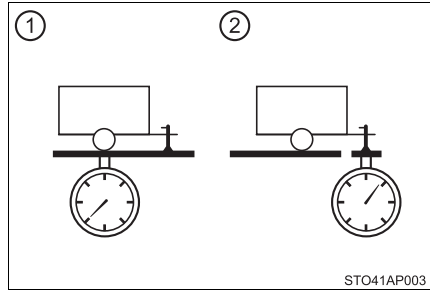

■ Information tag (manufacturer's label)

▶ Type A

- ① Gross vehicle mass
- ② Maximum permissible rear axle capacity

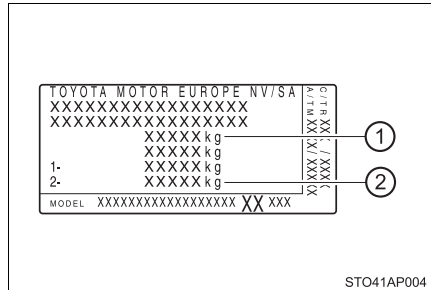

▶ Type B

- ① Gross vehicle mass
- ② Maximum permissible rear axle capacity

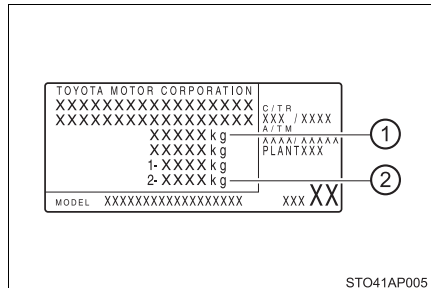

■ Gross vehicle mass

▶ Vehicle category M1 models*

The combined weight of the driver, passengers, luggage, towing hitch, total curb mass and drawbar load should not exceed the gross vehicle mass by more than 100 kg (220.5 lb.). Exceeding this weight is dangerous.

▶ Vehicle category N1 models*

The combined weight of the driver, passengers, cargo, towing hitch, total curb mass and drawbar load must not exceed the gross vehicle mass. Exceeding this weight is dangerous.

■ **Maximum permissible rear axle capacity**

▶ Vehicle category M1 models*

The weight borne by the rear axle should not exceed the maximum permissible rear axle capacity by 15% or more. Exceeding this weight is dangerous.

▶ Vehicle category N1 models*

The weight borne by the rear axle should not exceed the maximum permissible rear axle capacity. Exceeding this weight is dangerous.

The values for towing capacity were derived from testing conducted at sea level. Take note that engine output and towing capacity will be reduced at high altitudes.



WARNING

■ **When the gross vehicle mass or maximum permissible axle capacity is exceeded (vehicle category M1 models*)**

Failing to observe this precaution may lead to an accident causing death or serious injury.

- Add an additional 20.0 kPa (0.2 kgf/cm² or bar, 3 psi) to the tire inflation pressure.
- Do not exceed the established speed limit for towing a trailer in built-up areas or 100 km/h (62 mph), whichever is lower.

*: To distinguish the vehicle category, ask any authorized Toyota dealer or repairer, or another duly qualified and equipped professional.

Installation positions* for the towing hitch/bracket and hitch ball

- ① 434 mm (17.1 in.)
- ② 434 mm (17.1 in.)

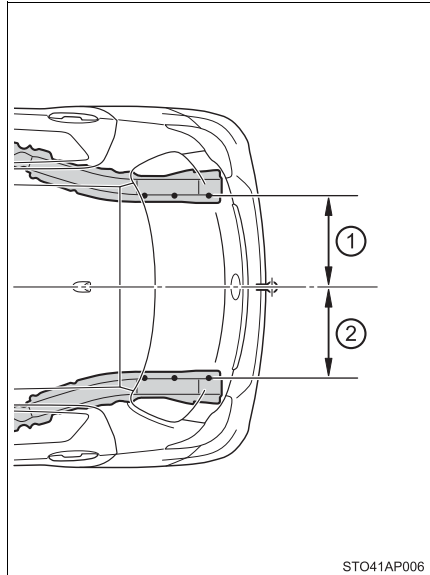

- ③ 655 mm (25.8 in.)
- ④ 602 mm (23.7 in.)
- ⑤ 468 mm (18.4 in.)
- ⑥ 313 mm (12.3 in.)
- ⑦ 397 mm (15.6 in.)
- ⑧ 26.2 mm (1.0 in.)

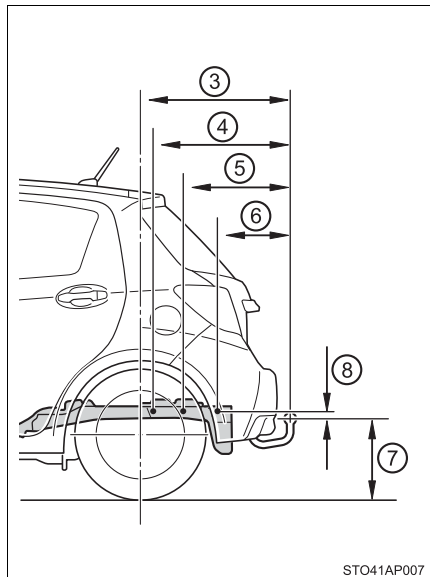

*: Gross vehicle mass and standard tire size

To distinguish the vehicle category, ask any authorized Toyota dealer or repairer, or another duly qualified and equipped professional.

■ Tire information

- Increase the tire inflation pressure to 20.0 kPa (0.2 kgf/cm² or bar, 3 psi) greater than the recommended value when towing. (→P. 483)
- Increase the air pressure of the trailer tires in accordance with the total trailer weight and according to the values recommended by the manufacturer of your trailer.

■ Trailer lights

Check that the turn signal lights and stoplights are operating correctly every time you hitch up the trailer. Directly wiring up to your vehicle may damage the electrical system and stop the lights from functioning correctly.

■ Break-in schedule

Toyota recommends that vehicles fitted with new power train components should not be used for towing trailers for the first 800 km (500 miles).

■ Safety checks before towing

- Check that the maximum load limit for the towing hitch/bracket and hitch ball is not exceeded. Bear in mind that the coupling weight of the trailer will add to the load exerted on the vehicle. Also make sure that the total load exerted on the vehicle is within the range of the weight limits. (→P. 174)
- Ensure that the trailer load is secure.
- Supplementary outside rear view mirrors should be added to the vehicle if the traffic behind cannot be clearly seen with standard mirrors. Adjust the extending arms of these mirrors on both sides of the vehicle so that they always provide maximum visibility of the road behind.

■ Maintenance

- Maintenance must be performed more frequently when using the vehicle for towing due to the greater weight burden placed on the vehicle compared to normal driving.
- Retighten all bolts securing the hitching ball and bracket after towing for approximately 1000 km (600 miles).

**NOTICE****■ When the rear bumper strengthening material is aluminum**

Ensure the steel bracket part does not come directly in contact with that area.

When steel and aluminum come into contact, there is a reaction similar to corrosion, which will weaken the section concerned and may result in damage. Apply a rust inhibitor to parts that will come in contact when attaching a steel bracket.

Guidance

Your vehicle will handle differently when towing a trailer. In order to avoid accident, death or serious injury, keep the following in mind when towing:

■ Checking connections between trailer and lights

Stop the vehicle and check the operation of the connection between the trailer and lights after driving for a brief period as well as before starting off.

■ Practicing driving with a coupled trailer

- Get the feel for turning, stopping and reversing with the trailer coupled by practicing in an area with no or light traffic.
- When reversing with a coupled trailer, hold the section of the steering wheel nearest to you and rotate clockwise to turn the trailer left or counterclockwise to turn it right. Always rotate a little at a time to prevent steering error. Have someone guide you when reversing to lessen the risk of an accident.

■ Increasing vehicle-to-vehicle distance

At a speed of 10 km/h (6 mph), the distance to the vehicle running ahead of you should be equivalent to or greater than the combined length of your vehicle and trailer. Avoid sudden braking that may cause skidding. Otherwise, the vehicle may spin out of control. This is especially true when driving on wet or slippery road surfaces.

■ **Sudden acceleration/steering input/cornering**

Executing sharp turns when towing may result in the trailer colliding with your vehicle. Decelerate well in advance when approaching turns and take them slowly and carefully to avoid sudden braking.

■ **Important points regarding turning**

The wheels of the trailer will travel closer to the inside of the curve than the wheels of the vehicle. To make allowance for this, take the turns wider than you would normally do.

■ **Important points regarding stability**

Vehicle movement resulting from uneven road surfaces and strong crosswinds will affect handling. The vehicle may also be rocked by passing buses or large trucks. Frequently check behind when moving alongside such vehicles. As soon as such vehicle movement occurs, immediately start to decelerate smoothly by slowly applying the brakes. Always steer the vehicle straight ahead while braking.

■ **Passing other vehicles**

Consider the total combined length of your vehicle and trailer and ensure that the vehicle-to-vehicle distance is sufficient before executing lane changes.

■ **Transmission information**

▶ Vehicles with a Multidrive

To maintain engine braking efficiency, when using engine braking, do not use the transmission in D. Transmission shift gear position must be in 4 in the M mode. (→P. 191)

▶ Vehicles with a manual transmission

To maintain engine braking efficiency, when using engine braking, do not use the transmission in 5 and 6 (vehicles with a 6-speed manual transmission) gear. (→P. 196)

■ If the engine overheats

Towing a loaded trailer up a long, steep incline in temperatures exceeding 30°C (85°F) may result in the engine overheating. If the high engine coolant temperature warning light flashes or comes on, turn the air conditioning off immediately, leave the road and stop the vehicle in a safe place. (→P. 458)

■ When parking the vehicle

Always place wheel chocks under the wheels of both the vehicle and trailer. Firmly set the parking brake and shift the shift lever to P for Multidrives or 1 or R for manual transmissions.

WARNING

Follow all the instructions described in this section. Failure to do so could cause an accident resulting in death or serious injury.

■ Trailer towing precautions

When towing, make sure that none of the weight limits are exceeded. (→P. 174)

■ Vehicle speed in towing

Observe the legal maximum speeds for trailer towing.

■ Before descending hills or long declines

Reduce speed and downshift. However, never downshift suddenly while descending steep or long downhill grades.

■ Operation of the brake pedal

Do not hold the brake pedal depressed often or for long periods of time. Doing so may result in the brake overheating or reduce braking effects.

■ To avoid accident or injury

- Vehicles with a cruise control: Do not use cruise control when you are towing.
- Vehicles with a compact spare tire: Do not tow a trailer when the compact spare tire is installed on your vehicle.
- Vehicles with an emergency tire puncture repair kit: Do not tow a trailer when the tire installed is repaired with the emergency tire puncture repair kit.

Engine (ignition) switch (vehicles without a smart entry & start system)

Starting the engine

► Gasoline engine

- 1 Check that the parking brake is set.
- 2 Check that the shift lever is set in P (Multidrive) or N (manual transmission).
- 3 Firmly depress the brake pedal (Multidrive) or clutch pedal (manual transmission).
- 4 Turn the engine switch to the “START” position to start the engine.

► Diesel engine

- 1 Check that the parking brake is set.
- 2 Check that the shift lever is set in N.
- 3 Firmly depress the clutch pedal.
- 4 Turn the engine switch to the “ON” position.

The  indicator turns on.

- 5 After the  indicator light goes out, turn the engine switch to the “START” position to start the engine.

Changing engine switch positions

① “LOCK”

The steering wheel is locked and the key can be removed. (Vehicles with a Multidrive: The key can be removed only when the shift lever is in P.)

② “ACC”

Some electrical components such as the audio system can be used.

③ “ON”

All electrical components can be used.

④ “START”

For starting the engine.

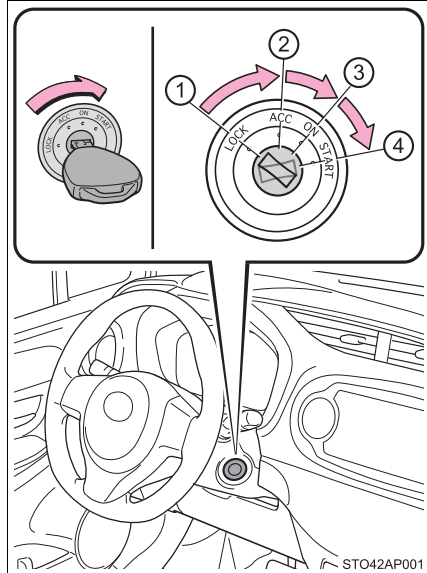

■ Turning the key from “ACC” to “LOCK”

- ① Shift the shift lever to P (Multidrive) or N (manual transmission). (→P. 191, 196)
- ② Push in the key and turn it to the “LOCK” position.

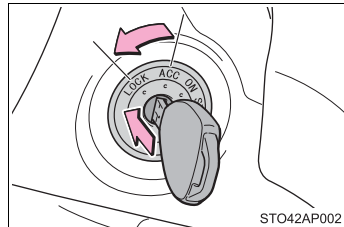

■ If the engine does not start

The engine immobilizer system may not have been deactivated. (→P. 74)
Contact any authorized Toyota dealer or repairer, or another duly qualified and equipped professional.

■ When the steering lock cannot be released

When starting the engine, the engine switch may seem stuck in the “LOCK” position. To free it, turn the key while turning the steering wheel slightly left and right.

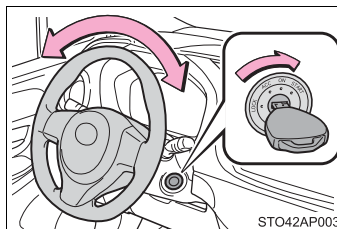

■ Key reminder function

A buzzer sounds if the driver's door is opened while the engine switch is in the “LOCK” or “ACC” position to remind you to remove the key.

⚠ WARNING

■ When starting the engine

Always start the engine while sitting in the driver's seat. Do not depress the accelerator pedal while starting the engine under any circumstances. Doing so may cause an accident resulting in death or serious injury.

■ Caution when driving

Do not turn the engine switch to the “LOCK” position while driving. If, in an emergency, you must turn the engine off while the vehicle is moving, turn the engine switch only to the “ACC” position to stop the engine. An accident may result if the engine is stopped while driving. (→P. 395)

⚠ NOTICE

■ To prevent battery discharge

Do not leave the engine switch in the “ACC” or “ON” position for long periods of time without the engine running.

■ When starting the engine

- Do not crank the engine for more than 30 seconds at a time. This may overheat the starter and wiring system.
- Do not race a cold engine.
- If the engine becomes difficult to start or stalls frequently, have your vehicle checked by any authorized Toyota dealer or repairer, or another duly qualified and equipped professional immediately.

Engine (ignition) switch (vehicles with a smart entry & start system)

Performing the following operations when carrying the electronic key on your person starts the engine or changes engine switch mode.

Starting the engine

- 1 Check that the parking brake is set.
- 2 Check that the shift lever is set in P (Multidrive) or N (manual transmission).
- 3 Firmly depress the brake pedal (Multidrive) or clutch pedal (manual transmission).

The smart entry & start system indicator light (green) will turn on. If the indicator light does not turn on, the engine cannot be started.

- 4 Press the engine switch.

The engine will crank until it starts or for up to 30 seconds, whichever is less.

Continue depressing the brake pedal (Multidrive) or clutch pedal (manual transmission) until the engine is completely started.

Diesel engine only: The  indicator turns on. The engine will start after the indicator light goes out.

The engine can be started from any engine switch mode.

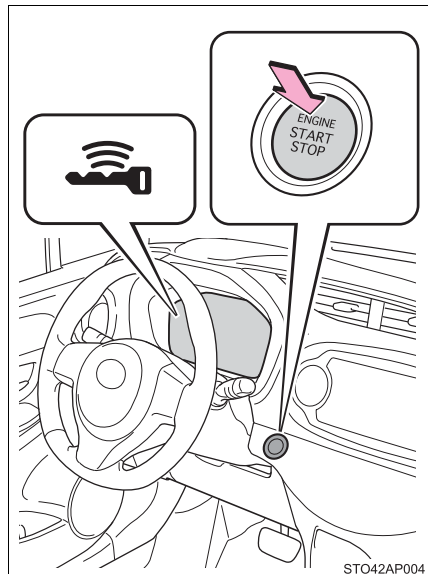

Stopping the engine

- 1 Stop the vehicle.
- 2 Shift the shift lever to P (Multidrive) or N (manual transmission).
- 3 Set the parking brake. (→P. 201)
- 4 Press the engine switch.
- 5 Release the brake pedal (Multidrive) or clutch pedal (manual transmission) and check that the smart entry & start system indicator light (green) is off.

Changing engine switch modes

Modes can be changed by pressing the engine switch with brake pedal (Multidrive) or clutch pedal (manual transmission) released. (The mode changes each time the switch is pressed.)

Off*

The emergency flashers can be used.

The smart entry & start system indicator light (green) is off.

ACCESSORY mode

Some electrical components such as the audio system can be used.

The smart entry & start system indicator light (green) flashes slowly.

IGNITION ON mode

All electrical components can be used.

The smart entry & start system indicator light (green) flashes slowly.

- *: Vehicles with a Multidrive: If the shift lever is in a position other than P when turning off the engine, the engine switch will be turned to ACCESSORY mode, not to off.

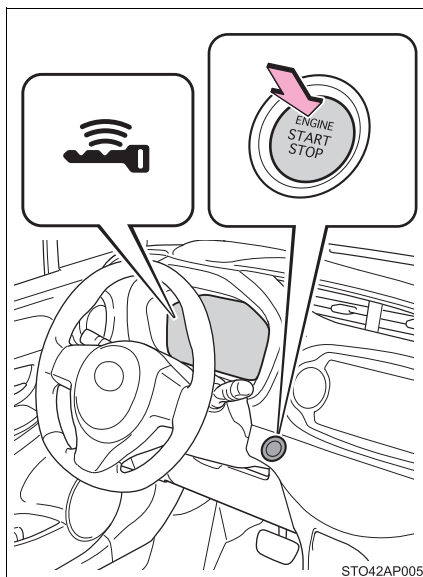

When stopping the engine with the shift lever in a position other than P (Multidrive)

If the engine is stopped with the shift lever in a position other than P, the engine switch will not be turned off but instead be turned to ACCESSORY mode. Perform the following procedure to turn the switch off:

- 1 Check that the parking brake is set.
- 2 Shift the shift lever to P.
- 3 Check that the smart entry & start system indicator light (green) flashes slowly and then press the engine switch once.
- 4 Check that the smart entry & start system indicator light (green) is off.

■ Auto power off function

▶ Vehicles with a Multidrive

If the vehicle is left in ACCESSORY or IGNITION ON mode (the engine is not running) for more than an hour with the shift lever in P, the engine switch will automatically turn off. However, this function cannot entirely prevent battery discharge. Do not leave the vehicle with the engine switch in ACCESSORY or IGNITION ON mode for long periods of time when the engine is not running.

▶ Vehicles with a manual transmission

If the vehicle is left in ACCESSORY or IGNITION ON mode (the engine is not running) for more than an hour, the engine switch will automatically turn off. However, this function cannot entirely prevent battery discharge. Do not leave the vehicle with the engine switch in ACCESSORY or IGNITION ON mode for long periods of time when the engine is not running.

■ Electronic key battery depletion

→P. 106

■ Conditions affecting operation

→P. 130

■ Notes for the entry function

→P. 131

■ If the engine does not start

- The engine immobilizer system may not have been deactivated. (→P. 74)
Contact any authorized Toyota dealer or repairer, or another duly qualified and equipped professional.
- On vehicles with a Multidrive, check that the shift lever is securely set in P. The engine may not start if the shift lever is displaced out of P. The smart entry & start system indicator light (green) will flash quickly.

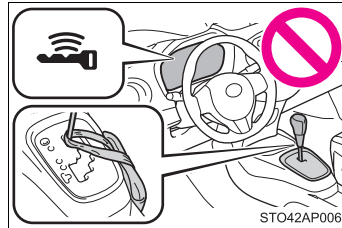

■ Steering lock

After turning the engine switch off and opening and closing the doors, the steering wheel will be locked due to the steering lock function. Operating the engine switch again automatically cancels the steering lock.

■ When the steering lock cannot be released

The smart entry & start system indicator light (green) will flash quickly.

- ▶ Vehicles with a Multidrive

Check that the shift lever is set in P.
Press the engine switch while turning the steering wheel left and right.

- ▶ Vehicles with a manual transmission

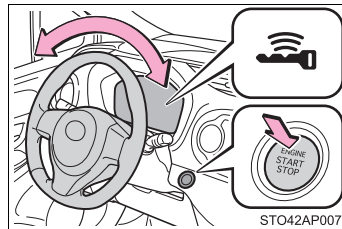

Press the engine switch while turning the steering wheel left and right.

■ Steering lock motor overheating prevention

To prevent the steering lock motor from overheating, the motor may be suspended if the engine is turned on and off repeatedly in a short period of time. In this case, refrain from operating the engine. After about 10 seconds, the steering lock motor will resume functioning.

■ If the system is malfunctioning

→P. 407

■ If the electronic key battery is depleted

→P. 367

■ Operation of the engine switch

When operating the engine switch, one short, firm press is enough. If the switch is pressed improperly, the engine may not start or the engine switch mode may not change. It is not necessary to press and hold the switch.

■ If the smart entry & start system has been deactivated in a customized setting

→P. 490

⚠ WARNING**■ When starting the engine**

Always start the engine while sitting in the driver's seat. Do not depress the accelerator pedal while starting the engine under any circumstances. Doing so may cause an accident resulting in death or serious injury.

■ Caution while driving

If engine failure occurs while the vehicle is moving, do not lock or open the doors until the vehicle reaches a safe and complete stop. Activation of the steering lock in this circumstance may lead to an accident, resulting in death or serious injury.

■ Stopping the engine in an emergency

If you want to stop the engine in an emergency while driving the vehicle, press and hold the engine switch for more than 3 seconds, or press it briefly 3 times or more in succession. (→P. 395)

However, do not touch the engine switch while driving except in an emergency. Turning the engine switch off while driving will not cause loss of steering or braking control, but the power assist to these systems will be lost. This will make it more difficult to steer and brake, so you should pull over and stop the vehicle as soon as it is safe to do so.

**NOTICE****■ To prevent battery discharge**

- Do not leave the engine switch in ACCESSORY or IGNITION ON mode for long periods of time without the engine running.
- If the smart entry & start system indicator light (green) is illuminated, the engine switch is not off. When exiting the vehicle, always check that the engine switch is off.
- On vehicles with a Multidrive, do not stop the engine when the shift lever is in a position other than P. If the engine is stopped in another shift lever position, the engine switch will not be turned off but instead be turned to ACCESSORY mode. If the vehicle is left in ACCESSORY mode, battery discharge may occur.

■ When starting the engine

- Do not race a cold engine.
- If the engine becomes difficult to start or stalls frequently, have your vehicle checked by any authorized Toyota dealer or repairer, or another duly qualified and equipped professional immediately.

■ Symptoms indicating a malfunction with the engine switch

If the engine switch seems to be operating somewhat differently than usual, such as the switch sticking slightly, there may be a malfunction. Contact any authorized Toyota dealer or repairer, or another duly qualified and equipped professional immediately.

Multidrive*

Shifting the shift lever

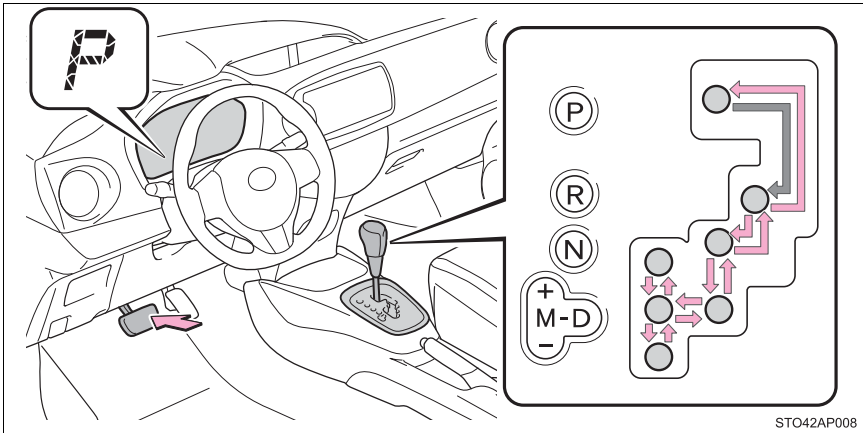

▶ Vehicles without a smart entry & start system

- ← While the engine switch is in the “ON” position, move the shift lever with the brake pedal depressed.

When shifting the shift lever between P and D, make sure that the vehicle is completely stopped.

▶ Vehicles with a smart entry & start system

- ← While the engine switch is in IGNITION ON mode, move the shift lever with the brake pedal depressed.

When shifting the shift lever between P and D, make sure that the vehicle is completely stopped.

Shift position purpose

Shift position	Function
P	Parking the vehicle or starting the engine
R	Reversing
N	Neutral
D	Normal driving ^{*1} or temporary gear step selection driving ^{*2}
M	7-speed sport sequential shiftmatic mode driving (→P. 193)

*1: To improve fuel consumption and reduce noises, set the shift lever in the D position for normal driving.

*2: By selecting gear step using paddle shift switches, you can control engine braking forces.

Selecting a driving mode

Press the switch.

For powerful acceleration and driving in mountainous regions.

The "SPORT" indicator will come on.

Press the switch once more to return the normal mode.

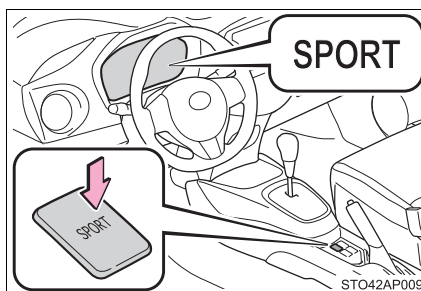

Changing gear steps in 7-speed sport sequential shiftmatic mode

Shift the shift lever to the M position and operate the shift lever or paddle shift switch.

- ① Upshifting
- ② Downshifting

The gear step changes once every time the shift lever or paddle shift switch is operated.

The selected gear step, from 1 to 7, will be displayed in the multi-information display.

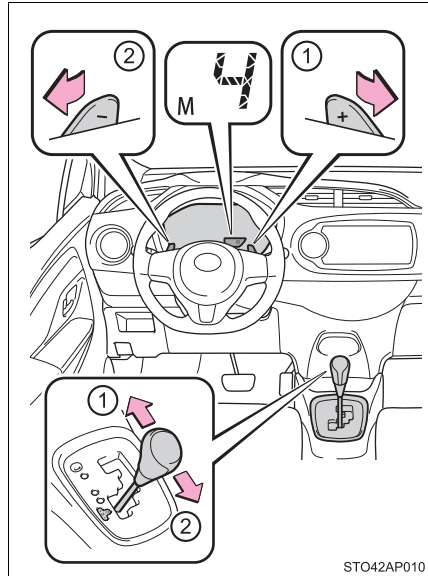

However, even when in the M position, the gear steps will be automatically changed if the engine speed is too high, or too low.

■ Gear step functions

- You can choose from 7 levels of engine braking force.
- A lower gear step will provide greater engine braking force than a higher gear step, and the engine speed will also increase.

Temporarily gear steps selection mode in the D position

To drive in temporary gear steps selection mode, operate the “-” and “+” paddle shift switch. The gear steps can then be selected by operating the “-” and “+” paddle shift switches. By selecting gear step using paddle shift switches, you can control engine braking forces.

- ① Upshifting
- ② Downshifting

The gear step changes once every time the paddle shift switch is operated.

The selected gear step, from 1 to 7, will be displayed in the multi-information display

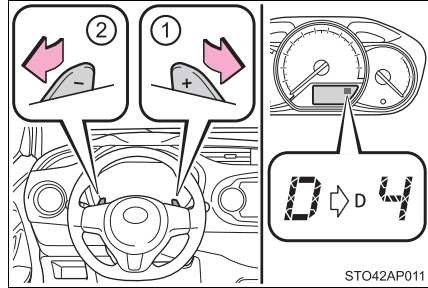

However, even when in the D position, the gear steps will be automatically changed if the speed is too high, or too low.

■ Gear step functions

→P. 193

■ Deactivation of the temporarily gear steps selection mode in the D position

In the following situations, temporarily gear steps selection mode in the D position will be deactivated:

- When the vehicle comes to a stop
- If the accelerator pedal is depressed for more than a certain period of time in one gear step
- When the “+” paddle shift switch is held down for a period of time

■ When driving with the cruise control activated (if equipped)

Even when performing the following actions with the intent of enabling engine braking, engine braking will not activate because cruise control will not be canceled.

- While driving in D or 7-speed sport sequential shiftmatic mode, downshifting to 6, 5, or 4. (→P. 193)
- When switching the driving mode to sport mode while driving in D position. (→P. 192)

- **When the vehicle comes to a stop with the shift lever in the M position**
 - The transmission will automatically downshift to M1 once the vehicle is stopped.
 - After a stop, the vehicle will start off in M1.
 - When the vehicle is stopped, the transmission is set at M1.

- **If the shift lever cannot be shifted from P**

→P. 450

- **If the “M” indicator flashes or a buzzer beeps after shifting the shift lever to M**

This may indicate a malfunction in the Multidrive system. Have the vehicle inspected by any authorized Toyota dealer or repairer, or another duly qualified and equipped professional immediately.

(In this situation, the transmission will operate in the same manner as when the shift lever is in D.)

- **Downshift restriction warning buzzer (vehicles with a 7-speed sport sequential shiftmatic mode)**

To help ensure safety and driving performance, downshifting operation may sometimes be restricted. In some circumstances, downshifting may not be possible even when the shift lever or paddle shift switches are operated. (A buzzer will sound twice.)

 **WARNING**

- **When driving on slippery road surfaces**

Do not accelerate or shift gears suddenly.

Sudden changes in engine braking may cause the vehicle to spin or skid, resulting in an accident.

Manual transmission*

Shifting the shift lever

► 5-speed transmission

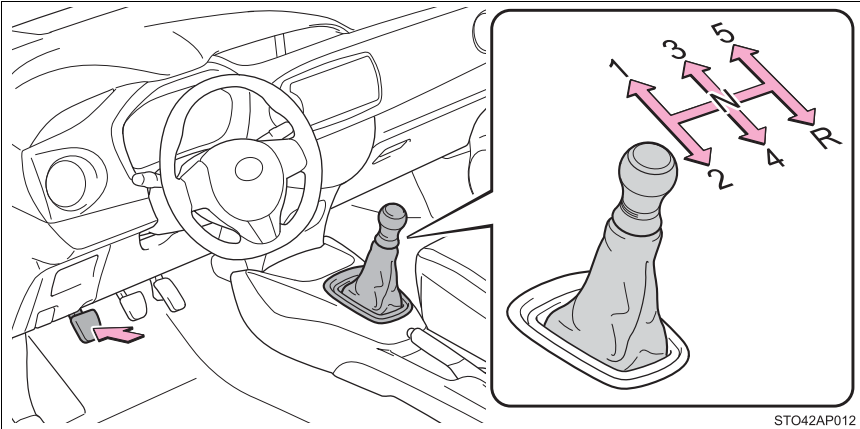

Fully depress the clutch pedal before operating the shift lever, and then release it slowly.

If it is difficult to shift in reverse, shift the shift lever to N, release the clutch pedal momentarily, and then try again.

► 6-speed transmission

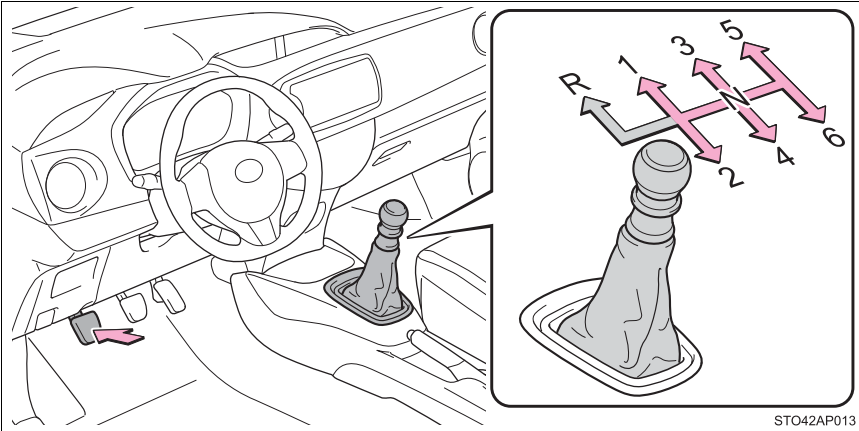

Fully depress the clutch pedal before operating the shift lever, and then release it slowly.

Shifting the shift lever to R (6-speed transmission)

Shift the shift lever to R while lifting up the ring section.

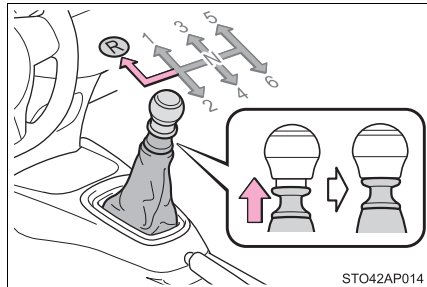

Gear Shift Indicator

The Gear Shift Indicator is a guide to help the driver achieve improved fuel economy and reduced exhaust emissions within limits of engine performance.

- ① Upshifting
- ② Downshifting

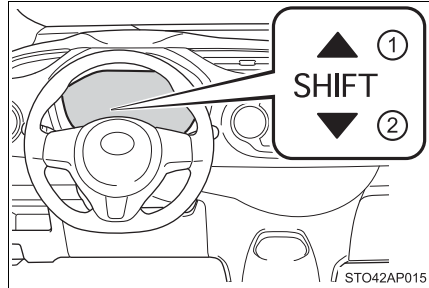

■ Gear Shift Indicator display

The Gear Shift Indicator may not be displayed when your foot is placed on the clutch pedal.

■ Maximum downshifting speeds

Observe the downshifting speeds in the following table to prevent over-revving the engine.

km/h (mph)

Shift position	Maximum speed		
	1KR-FE engine	1NR-FE engine	1ND-TV engine
1	45 (28)	46 (29)	43 (27)
2	84 (52)	85 (53)	80 (50)
3	123 (76)	124 (77)	117 (73)
4	157 (98)	158 (98)	158 (98)

⚠ WARNING**■ Gear Shift Indicator display**

For safety, the driver should not look only at the display. Refer to the display when it is safe to do so while considering actual traffic and road conditions. Failure to do so may lead to an accident.

⚠ NOTICE**■ To prevent damage to the 6-speed transmission**

- Do not shift the shift lever to R without depressing the clutch pedal.

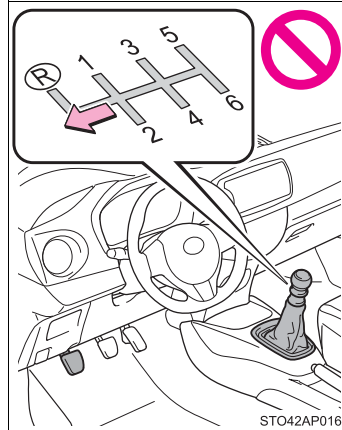

- Do not lift up the ring section except when shifting the lever to R.
- Shift the shift lever to R only when the vehicle is stationary.

Turn signal lever

Operation instructions

- ① Right turn
- ② Lane change to the right (push and hold the lever partway)
The right hand signals will flash until you release the lever.
- ③ Lane change to the left (push and hold the lever partway)
The left hand signals will flash until you release the lever.
- ④ Left turn

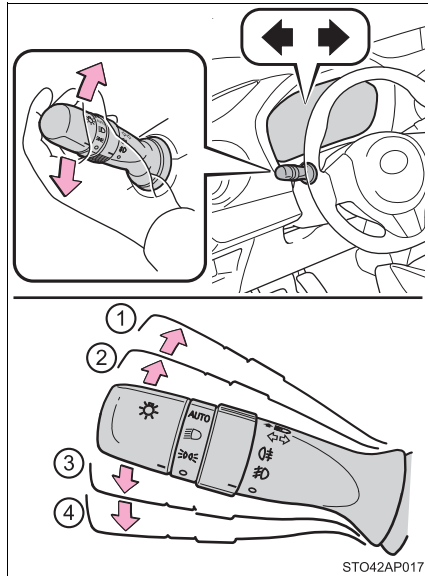

STO42AP017

■ Turn signals can be operated when

- ▶ Vehicles without a smart entry & start system
The engine switch is in the "ON" position.
- ▶ Vehicles with a smart entry & start system
The engine switch is in IGNITION ON mode.

■ If the indicator flashes faster than usual

Check that a light bulb in the front or rear turn signal lights has not burned out.

Parking brake

Operation instructions

- ① To set the parking brake, fully pull the parking brake lever while depressing the brake pedal.
- ② To release the parking brake, slightly raise the lever and lower it completely while pressing the button.

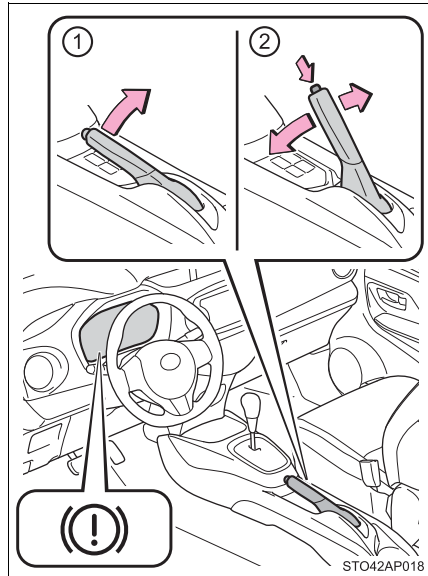

■ Parking brake engaged warning buzzer

→P. 405

■ Usage in winter time

→P. 243

⚠ NOTICE

■ Before driving

Fully release the parking brake.



Driving the vehicle with the parking brake set will lead to brake components overheating, which may affect braking performance and increase brake wear.

Headlight switch

The headlights can be operated manually or automatically.

Operation instructions

Turning the end of the lever turns on the lights as follows:

- ① ○ Off
- ②  The front position, tail, license plate and instrument panel lights turn on.
- ③  The headlights and all the lights listed above turn on.
- ④ AUTO (If equipped) Vehicles without a smart entry & start system: The headlights, front position lights and so on turn on and off automatically (when the engine switch is in the "ON" position.)

Vehicles with a smart entry & start system: The headlights, front position lights and so on turn on and off automatically (when the engine switch is in IGNITION ON mode.)

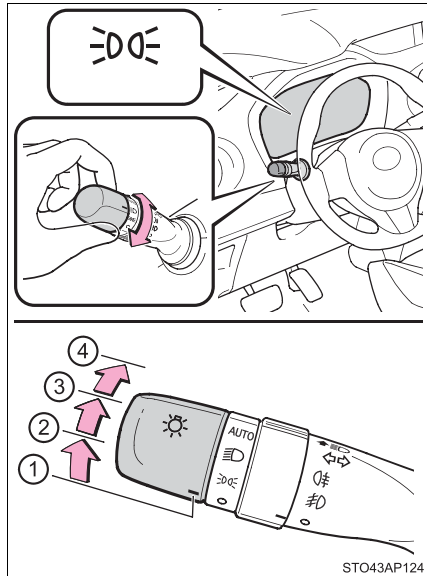

Turning on the high beam headlights

- ① With the headlights on, push the lever away from you to turn on the high beams.
Pull the lever toward you to the center position to turn the high beams off.
- ② Pull the lever toward you and release it to flash the high beams once.

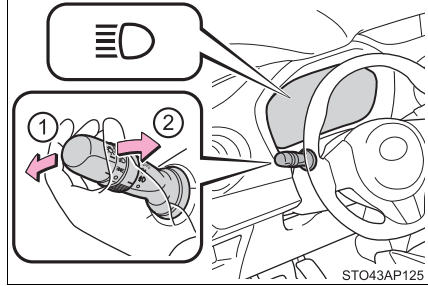

You can flash the high beams with the headlights on or off.

Follow me home system

This system allows the low beam headlights to be turned on for 30 seconds when the engine switch is turned off.

Pull the lever toward you and release it with the light switch is in **AUTO** or **o** after turning the engine switch off.

Pull the lever toward you and release it again to turn off the lights.

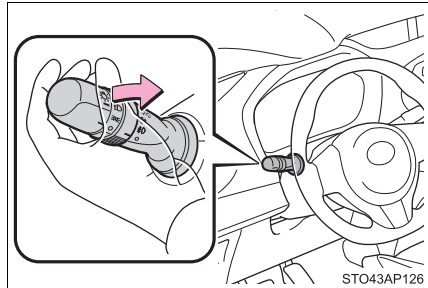

Manual headlight leveling dial

The level of the headlights can be adjusted according to the number of passengers and the loading condition of the vehicle.

▶ Left-hand drive vehicles

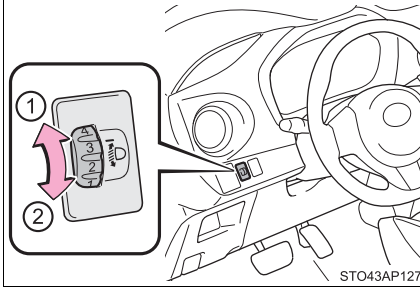

- ① Raises the level of the headlights
- ② Lowers the level of the headlights

▶ Right-hand drive vehicles

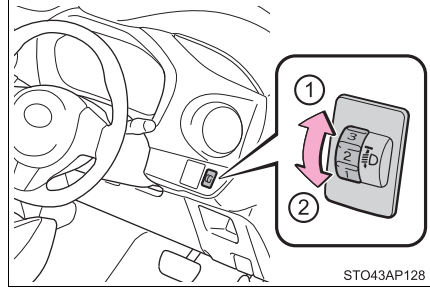

- ① Raises the level of the headlights
- ② Lowers the level of the headlights

■ Guide to dial settings

▶ Vehicle category M1*

Loading condition	Control switch position
Driver only	0
Driver + one passenger in the front seat	0
Driver + one passenger in the front seat + rear seat	1.5
All passengers	1.5
All passengers + full luggage loading to the luggage room	2.5
Driver + full luggage loading to the luggage room	4

► Vehicle category N1*

Loading condition	Control switch position
Driver only	0
Driver + full luggage loading to the luggage room	4

*: To distinguish the vehicle category, ask any authorized Toyota dealer or repairer, or another duly qualified and equipped professional.

■ **Daytime running light system**

To make your vehicle more visible to other drivers, the daytime running lights turn on automatically when the parking brake lever is released, if engine is started. (However, these lights will dim when the headlight switch is operated manually or the automatic headlight system turns on the tail lights.) Daytime running lights are not designed for use at night.

■ **Headlight control sensor (if equipped)**

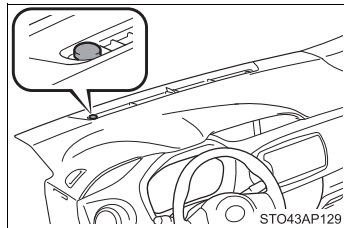

The sensor may not function properly if an object is placed on the sensor, or anything that blocks the sensor is affixed to the windshield.

Doing so interferes with the sensor detecting the level of ambient light and may cause the automatic headlight system to malfunction.





■ Automatic light off system (if equipped)



▶ Vehicles without a smart entry & start system

● When the light switch is in  or  : The headlights and front fog lights turn off automatically when the engine switch is turned to the “LOCK” position.



● When the light switch is in AUTO : The headlights and all the lights turn off automatically when the engine switch is turned to the “LOCK” position.

To turn the lights on again, turn the engine switch to the “ON” position, or turn the light switch off once and then back to  or  .

▶ Vehicles with a smart entry & start system

● When the light switch is in  or  : The headlights and front fog lights turn off automatically when the engine switch is turned off.

● When the light switch is in AUTO : The headlights and all the lights turn off automatically when the engine switch is turned off.

To turn the lights on again, turn the engine switch to IGNITION ON mode, or turn the light switch off once and then back to  or  .

■ Light reminder buzzer

▶ Vehicles without a smart entry & start system

A buzzer sounds when the key is removed from the engine switch and the driver’s door is opened while the lights are turned on.

▶ Vehicles with a smart entry & start system

A buzzer sounds when the engine switch is turned off and the driver’s door is opened while the lights are turned on.

■ Battery-saving function

In all conditions following below, the headlights and the other remaining lights will go off automatically after 20 minutes in order to prevent the vehicle battery from being discharged:

- The headlights and/or tail lights are on.
- The light switch is in  or AUTO .
- Vehicles without a smart entry & start system: The engine switch is turned to the “LOCK” position.
- Vehicles with a smart entry & start system: The engine switch is turned off.

This function will be canceled in any of the following situations:

- Vehicles without a smart entry & start system: When the engine switch is turned to the “ON” position.
- Vehicles with a smart entry & start system: When the engine switch is turned to IGNITION ON mode.
- When the light switch is operated.
- When the door is opened or closed.

■ Customization

Settings (e.g. light sensor sensitivity) can be changed.
(Customizable features: →P. 489)



NOTICE

■ To prevent battery discharge

Do not leave the lights on longer than necessary when the engine is not running.

Fog light switch

The fog lights secure excellent visibility in difficult driving conditions, such as in rain and fog.

Operation instructions

■ Rear fog light switch

- ① ○ Turns the rear fog lights off
- ② ◐ Turns the rear fog lights on
Releasing the switch ring returns it to ○ .
Operating the switch ring again turns the lights off.

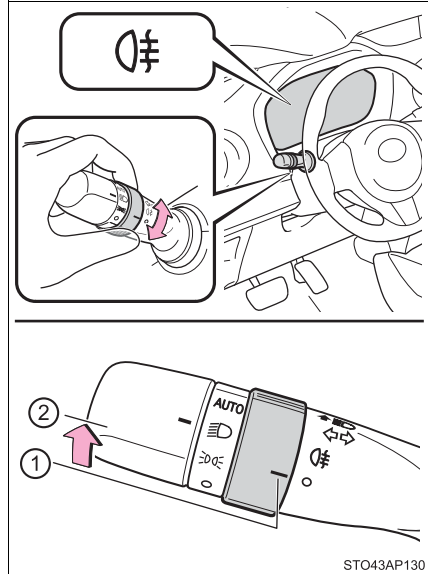

STO43AP130

■ Front and rear fog light switch (if equipped)

- ① ○ Turns the front and rear fog lights off
- ② ㊦ Turns the front fog lights on
- ③ ㊧ Turns both front and rear fog lights on

Releasing the switch ring returns it to ㊦.

Operating the switch ring again turns only the rear fog lights off.

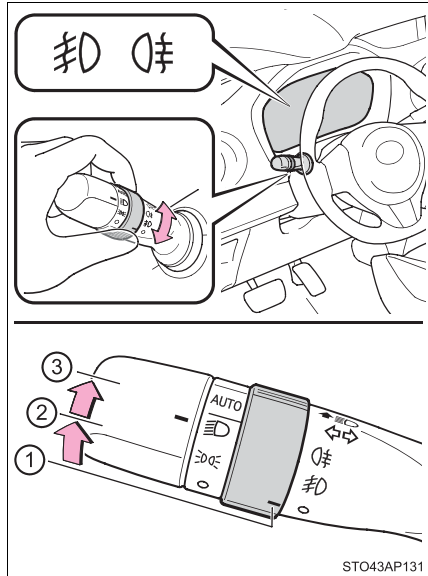

■ Fog lights can be used when

- ▶ Vehicles with a rear fog light switch

The headlights are turned on.

- ▶ Vehicles with a front and rear fog light switch

Front fog lights: The headlights or the front position lights are turned on.

Rear fog light: The front fog lights are turned on.

Windshield wiper and washer

Operating the wiper lever

Operate the lever as follows to operate the wiper.

► Intermittent windshield wiper

- ① ○ Off
- ②  Intermittent windshield wiper operation
- ③ ▼ Low speed windshield wiper operation
- ④ ▼ High speed windshield wiper operation
- ⑤ ▲ Temporary operation

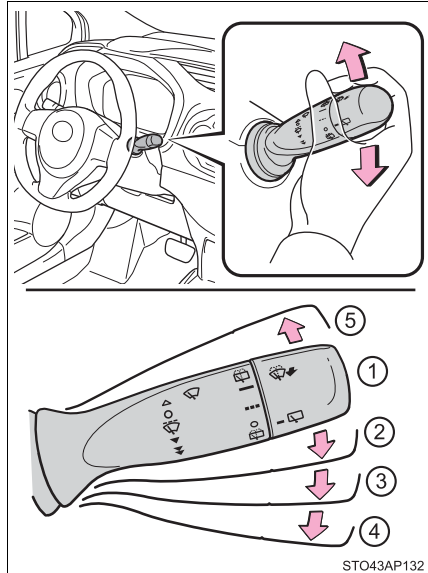

⑥ Washer/wiper dual operation

The wiper will automatically operate a couple of times after the washer squirts.

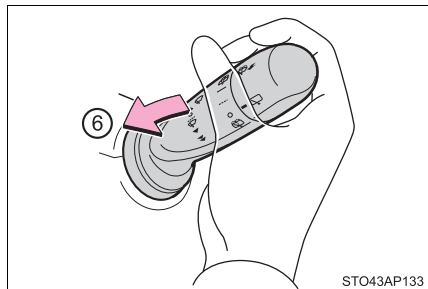

► Rain-sensing windshield wiper

When **AUTO** is selected, the wiper will operate automatically when the sensor detects falling rain. The system automatically adjusts wiper timing in accordance with rain volume and vehicle speed.

When **AUTO** is selected, the sensor sensitivity can be adjusted as follows by turning the switch ring:

- ① ○ Off
- ② AUTO Rain-sensing windshield wiper operation
- ③ ▼ Low speed windshield wiper operation
- ④ ▼ High speed windshield wiper operation
- ⑤ ▲ Temporary operation

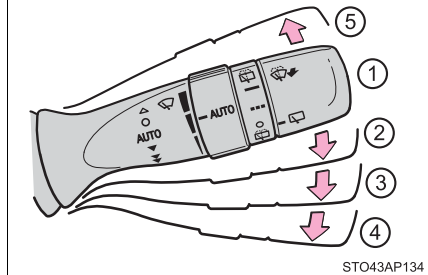
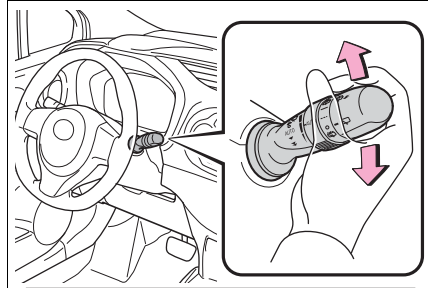

STO43AP134

- ⑥ Increases the sensitivity
- ⑦ Decreases the sensitivity

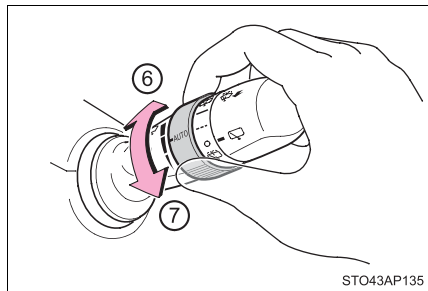

STO43AP135

⑧ Washer/wiper dual operation

The wiper will automatically operate a couple of times after the washer squirts.

(After operating several times, the wiper operate one more time after a short delay to prevent dripping.)

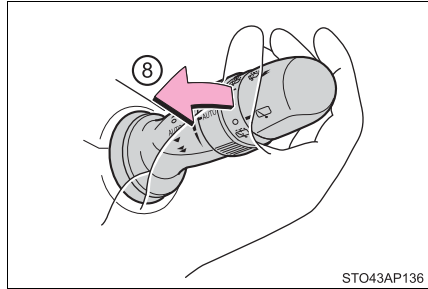

STO43AP136

■ The windshield wiper and washer can be operated when

- ▶ Vehicles without a smart entry & start system

The engine switch is in the “ON” position.

- ▶ Vehicles with a smart entry & start system

The engine switch is in IGNITION ON mode.

■ Raindrop sensor (vehicles with a rain-sensing windshield wiper)

- The raindrop sensor judges the amount of raindrops.

An optical sensor is adopted. It may not operate properly when sunlight from the rising or setting of the sun intermittently strikes the windshield, or if bugs etc. are present on the windshield.

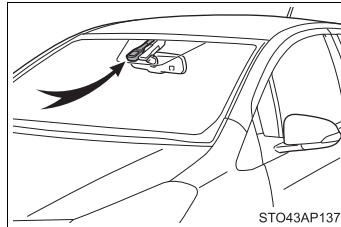

STO43AP137

- Vehicles without a smart entry & start system: If the wiper switch is turned to the **AUTO** position while the engine switch is in the “ON” position, the wiper will operate once to show that “AUTO” mode is activated.
- Vehicles with a smart entry & start system: If the wiper switch is turned to the **AUTO** position while the engine switch is in IGNITION ON mode, the wiper will operate once to show that “AUTO” mode is activated.

- When the sensor sensitivity ring is turned toward high while in “AUTO” mode, the wiper will operate once to indicate that the sensor sensitivity is enhanced.
- If the temperature of the raindrop sensor is 90°C (194°F) or higher, or -15°C (5°F) or lower, automatic operation may not occur. In this case, operate the wiper in any mode other than “AUTO” mode.

■ If no windshield washer fluid sprays

Check that the washer nozzle is not blocked, if there is washer fluid in the windshield washer fluid reservoir.

WARNING

■ Caution regarding the use of windshield wiper in “AUTO” mode (vehicles with a rain-sensing windshield wiper)

The windshield wiper may operate unexpectedly if the sensor is touched or the windshield is subject to vibration in “AUTO” mode. Take care that your fingers, etc., do not become caught in the windshield wiper.

■ Caution regarding the use of washer fluid

When it is cold, do not use the washer fluid until the windshield becomes warm. The fluid may freeze on the windshield and cause low visibility. This may lead to an accident, resulting in death or serious injury.

NOTICE

■ When the windshield is dry

Do not use the wiper, as they may damage the windshield.

■ When there is no washer fluid spray from the nozzle

Damage to the washer fluid pump may be caused if the lever is pulled toward you and held continually.

■ When a nozzle becomes blocked



In this case, contact any authorized Toyota dealer or repairer, or another duly qualified and equipped professional.

Do not try to clear it with a pin or other object. The nozzle will be damaged.

Rear window wiper and washer*

Operation instructions

Turning the end of the lever turns on the rear window wiper and washer.

- ① ○ Off
- ② --- Intermittent window wiper operation
- ③ — Normal window wiper operation
- ④  Washer/wiper dual operation
- ⑤  Washer/wiper dual operation

The wiper will automatically operate a couple of times after the washer squirts.

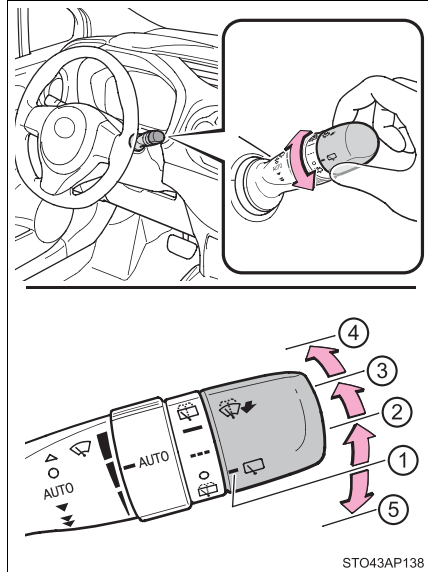

STO43AP138

■ The rear window wiper and washer can be operated when

- ▶ Vehicles without a smart entry & start system

The engine switch is in the "ON" position.

- ▶ Vehicles with a smart entry & start system

The engine switch is in IGNITION ON mode.

■ If no washer fluid sprays

Check that the washer nozzle is not blocked, if there is washer fluid in the washer fluid reservoir.

**NOTICE****■ When the rear window is dry**

Do not use the wiper, as it may damage the rear window.

■ When the washer fluid tank is empty

Do not operate the switch continually as the washer fluid pump may over-heat.

■ When a nozzle becomes blocked

In this case, contact any authorized Toyota dealer or repairer, or another duly qualified and equipped professional.

Do not try to clear it with a pin or other object. The nozzle will be damaged.

Opening the fuel tank cap

Perform the following steps to open the fuel tank cap:

Before refueling the vehicle

- Close all the doors and windows, and turn the engine switch to the “LOCK” position (vehicles without a smart entry & start system) or off (vehicles with a smart entry & start system).
- Confirm the type of fuel.

■ **Fuel types**

▶ Gasoline engine

EU area:

Unleaded gasoline conforming to European standard EN228, Research Octane Number of 95 or higher.

Except EU area:

Unleaded gasoline, Research Octane Number of 95 or higher

▶ Diesel engine

EU area:

Diesel fuel conforming to European standard EN590

Except EU area:

Diesel fuel that contains 50 ppm or less of sulfur and has a cetane number of 48 or higher

■ **Use of ethanol blended gasoline in a gasoline engine**

Toyota allows the use of ethanol blended gasoline where the ethanol content is up to 10%. Make sure that the ethanol blended gasoline to be used has a Research Octane Number that follows the above.

■ **Use of FAME blended diesel in a diesel engine**

- EU area: FAME (Fatty Acid Methyl Ester) fuel sold under names such as “B30” or “B100” and fuel containing a large amount of FAME should not be used. The use of these fuels will damage the vehicle’s fuel system. In case of any doubt, ask any authorized Toyota dealer or repairer, or another duly qualified and equipped professional.
- Except EU area: FAME (Fatty Acid Methyl Ester) fuel sold under names such as “B30” or “B100” and fuel containing a large amount of FAME should not be used. Your vehicle can use diesel mixed with 5% max biodiesel FAME (B5). The use of fuel with more than 5% FAME content (B5) will damage the vehicle’s fuel system. You must ensure that refueling is carried out only from a source where fuel specification and quality can be guaranteed. In case of any doubt, ask any authorized Toyota dealer or repairer, or another duly qualified and equipped professional.

 **WARNING****■ When refueling the vehicle**

Observe the following precautions while refueling the vehicle. Failure to do so may result in death or serious injury.

- After exiting the vehicle and before opening the fuel door, touch an unpainted metal surface to discharge any static electricity. It is important to discharge static electricity before refueling because sparks resulting from static electricity can cause fuel vapors to ignite while refueling.
- Always hold the grips on the fuel tank cap and turn it slowly to remove it. A whooshing sound may be heard when the fuel tank cap is loosened. Wait until the sound cannot be heard before fully removing the cap. In hot weather, pressurized fuel may spray out the filler neck and cause injury.
- Do not allow anyone that has not discharged static electricity from their body to come close to an open fuel tank.
- Do not inhale vaporized fuel.
Fuel contains substances that are harmful if inhaled.
- Do not smoke while refueling the vehicle.
Doing so may cause the fuel to ignite and cause a fire.
- Do not return to the vehicle or touch any person or object that is statically charged.
This may cause static electricity to build up, resulting in a possible ignition hazard.

■ When refueling

Observe the following precautions to prevent fuel overflowing from the fuel tank:

- Securely insert the fuel nozzle into the fuel filler neck.
- Stop filling the tank after the fuel nozzle automatically clicks off.
- Do not top off the fuel tank.

**NOTICE****Refueling**

Do not spill fuel during refueling.

Doing so may damage the vehicle, such as causing the emission control system to operate abnormally, damage fuel system components, or the vehicle's painted surface.

Opening the fuel tank cap

- 1 Pull up the opener to open the fuel filler door.

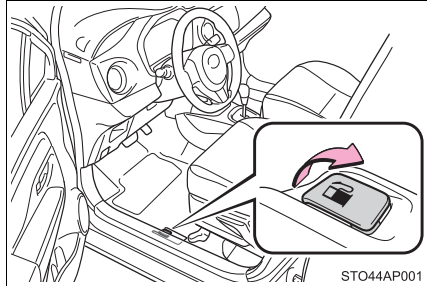

- 2 Turn the fuel tank cap slowly to open.

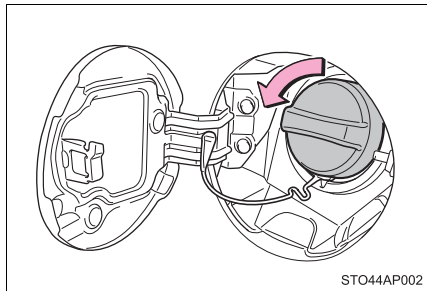

Closing the fuel tank cap

After refueling, turn the fuel tank cap until you hear a click. Once the cap is released, it will turn slightly in the opposite direction.

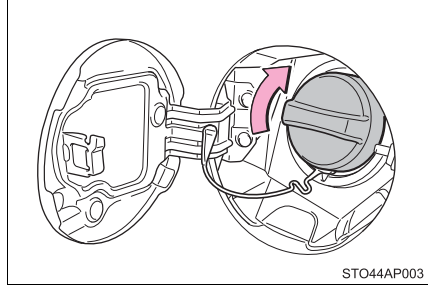

STO44AP003

WARNING

■ When replacing the fuel tank cap

Do not use anything but a genuine Toyota fuel tank cap designed for your vehicle. Doing so may cause a fire or other incident which may result in death or serious injury.

Cruise control*

Summary of functions

Use the cruise control to maintain a set speed without depressing the accelerator pedal.

- ① Indicators
- ② Cruise control switch

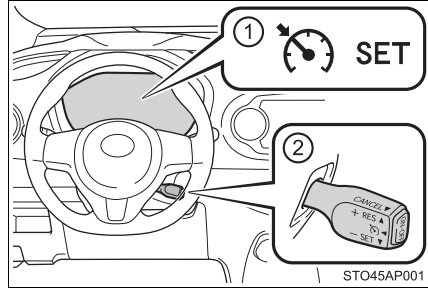

Setting the vehicle speed

- 1 Press the “ON-OFF” button to activate the cruise control.

Cruise control indicator (green) will come on.

Press the button again to deactivate the cruise control.

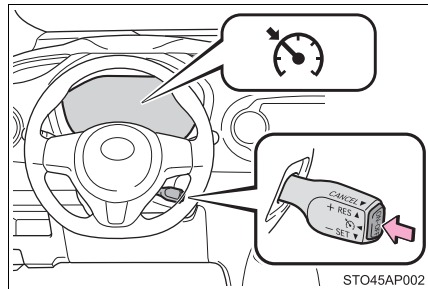

- 2 Accelerate or decelerate the vehicle to the desired speed, and push the lever down to set the speed.

“SET” indicator will come on.

The vehicle speed at the moment the lever is released becomes the set speed.

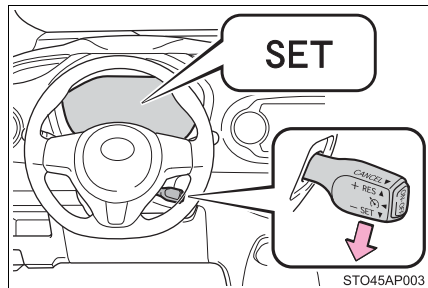

Adjusting the set speed

To change the set speed, operate the lever until the desired set speed is obtained.

- ① Increases the speed
- ② Decreases the speed

Fine adjustment: Momentarily move the lever in the desired direction.

Large adjustment: Hold the lever in the desired direction.

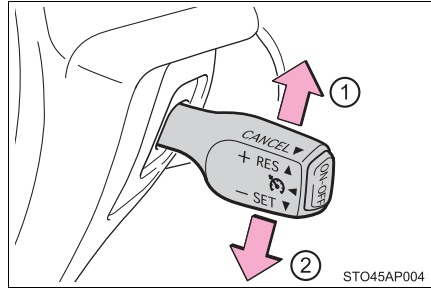

The set speed will be increased or decreased as follows:

Fine adjustment: By approximately 1.6 km/h (1 mph) each time the lever is operated.

Large adjustment: The set speed can be increased or decreased continually until the lever is released.

Canceling and resuming the constant speed control

- ① Pulling the lever toward you cancels the constant speed control.

The speed setting is also canceled when the brakes are applied or the clutch pedal (manual transmission only) is depressed.

- ② Pushing the lever up resumes the constant speed control.

Resuming is available when the vehicle speed is more than approximately 40 km/h (25 mph).

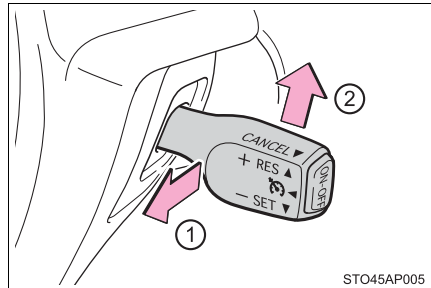

■ Cruise control can be set when

- ▶ Vehicles with a Multidrive
 - The shift lever is in the D or range 4 or higher of M has been selected.
 - Range 4 or higher has been selected by using the paddle shift.
 - Vehicle speed is above approximately 40 km/h (25 mph).
- ▶ Vehicles with a manual transmission
 - Vehicle speed is above approximately 40 km/h (25 mph).

■ Accelerating after setting the vehicle speed

- The vehicle can be accelerated normally. After acceleration, the set speed resumes.
- Even without canceling the cruise control, the set speed can be increased by first accelerating the vehicle to the desired speed and then pushing the lever down to set the new speed.

■ Automatic cruise control cancelation

Cruise control will stop maintaining the vehicle speed in any of the following situations.

- Actual vehicle speed falls more than approximately 16 km/h (10 mph) below the preset vehicle speed.
At this time, the memorized set speed is not retained.
- Actual vehicle speed is below approximately 40 km/h (25 mph).
- VSC is activated (if equipped).
- Speed limiter is activated (if equipped).

■ If the cruise control indicator light comes in yellow

Press the "ON-OFF" button once to deactivate the system, and then press the button again to reactivate the system.

If the cruise control speed cannot be set or if the cruise control cancels immediately after being activated, there may be a malfunction in the cruise control system. Have the vehicle inspected by any authorized Toyota dealer or repairer, or another duly qualified and equipped professional.

 **WARNING****■ To avoid operating the cruise control by mistake**

Switch the cruise control off using the “ON-OFF” button when not in use.

■ Situations unsuitable for cruise control

Do not use cruise control in any of the following situations.

Doing so may result in loss of control and could cause an accident resulting in death or serious injury.

- In heavy traffic
- On roads with sharp bends
- On winding roads
- On slippery roads, such as those covered with rain, ice or snow
- On steep hills
Vehicle speed may exceed the set speed when driving down a steep hill.
- During emergency towing

Speed limiter*

Summary of function

The desired maximum speed can be set using the cruise control switch. The speed limiter prevents vehicle speed from exceeding the set speed.

- ① Display
- ② Indicator (green)
- ③ Speed limiter switch

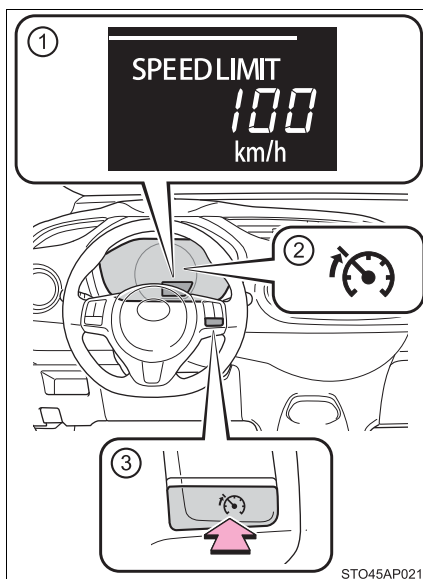

Setting the vehicle speed

- 1 Press the speed limiter switch to activate the speed limiter.
Speed limiter indicator (green) will come on.
Press the switch again to deactivate the speed limiter.

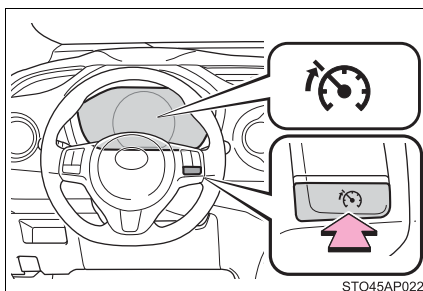

*: If equipped

- 2 Accelerate or decelerate the vehicle to the desired speed, and push the lever down to set the speed.

The vehicle speed at the moment the lever is released becomes the set speed.

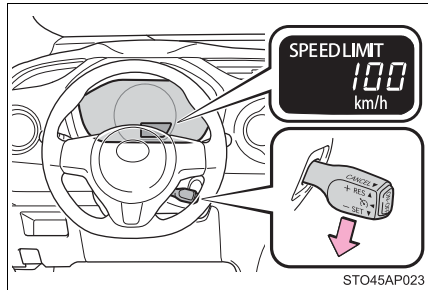

STO45AP023

Adjusting the set speed

To change the set speed, operate the lever until the desired set speed is obtained.

- ① Increases the speed
- ② Decreases the speed

Fine adjustment: Momentarily move the lever in the desired direction.

Large adjustment: Hold the lever in the desired direction.

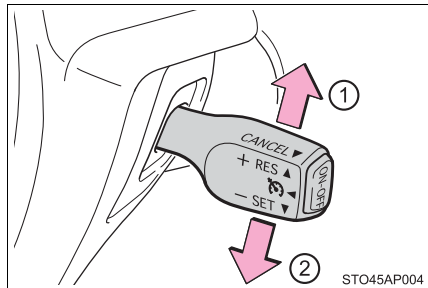

STO45AP004

- ▶ When the set speed is shown in “MPH”

Fine adjustment: By approximately 1.6 km/h (1 mph) each time the lever is operated.

Large adjustment: By approximately 8 km/h (5 mph) for each 0.75 seconds the lever is held.

- ▶ When the set speed is shown in “km/h”

Fine adjustment: By approximately 1 km/h (0.6 mph) each time the lever is operated.

Large adjustment: By approximately 5 km/h (3.1 mph) for each 0.75 seconds the lever is held.

Canceling and resuming the speed limiter

- ① Pulling the lever toward you cancels the speed limiter.
- ② Pushing the lever up resumes the speed limiter.

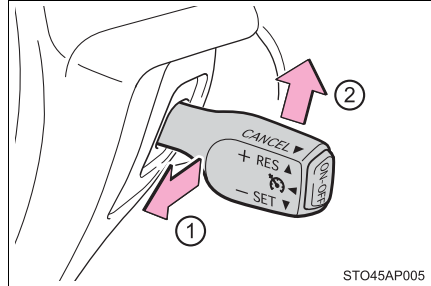

■ Speed limiter can be set when

The speed limiter can be set at any vehicle speed. However, if the speed limiter is set while the vehicle speed is below 30 km/h (18 mph), the speed limiter will be set to 30 km/h (18 mph).

■ Exceeding the set speed

In the following situation, the vehicle speed exceeds the set speed and multi-information display characters will flash:

- When fully depressing the accelerator pedal
- When driving down a hill way



■ Automatic speed limiter cancelation

The set speed is automatically canceled when the cruise control is activated.

 **WARNING****■ To avoid operating the speed limiter by mistake**

Switch the speed limiter off using the speed limiter switch when not in use.

■ Situations unsuitable for the speed limiter

Do not use the speed limiter in either of the following situations.

Doing so may result in loss of control and could cause a serious or fatal accident.

- On slippery roads, such as those covered with rain, ice and snow
- On steep hills
- When your vehicle is towing a trailer

Stop & start system*

The stop & start system stops and restarts the engine according to the brake pedal and shift lever operation (Multidrive) or clutch pedal operation (manual transmission) for stopping and starting the vehicle.

Stopping the engine

► Vehicles with a Multidrive

- 1 While driving in D or M, depress the brake pedal fully, and stop the vehicle.
- 2 The engine will stop and the Stop & Start indicator will come on.

When the shift lever is in N or P, the engine will remain stopped without depressing the brake pedal.

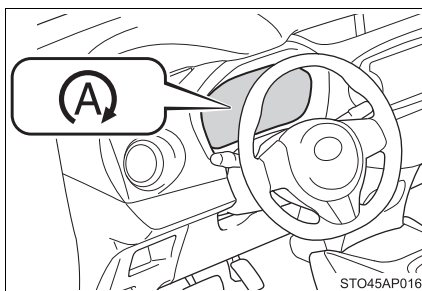

► Vehicles with a manual transmission

- 1 With the clutch pedal fully depressed, stop the vehicle. Then shift the shift lever to N.
- 2 Release the clutch pedal.

The engine will stop and the Stop & Start indicator will come on.

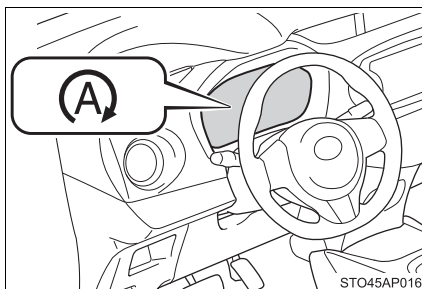

*: If equipped

Restarting the engine

- ▶ Vehicles with a Multidrive

Release the brake pedal. When the shift lever is in N or P, depress brake pedal and shift the shift lever to D or M.

The engine will restart. The Stop & Start indicator will go off.

- ▶ Vehicles with a manual transmission

Check that the shift lever is in N and depress the clutch pedal.

The engine will restart. The Stop & Start indicator will go off. (In this situation, releasing the clutch pedal will not stop the engine again.)

Disabling the Stop & start system

Press the Stop & Start cancel switch to disable the Stop & Start system.

The stop & start cancel indicator will come on.

The engine will not stop at each stop when the brake pedal (Multidrive) or clutch pedal (manual transmission) is depressed to stop the engine (→P. 228).

Pressing the switch again to re-enable the Stop & Start system.

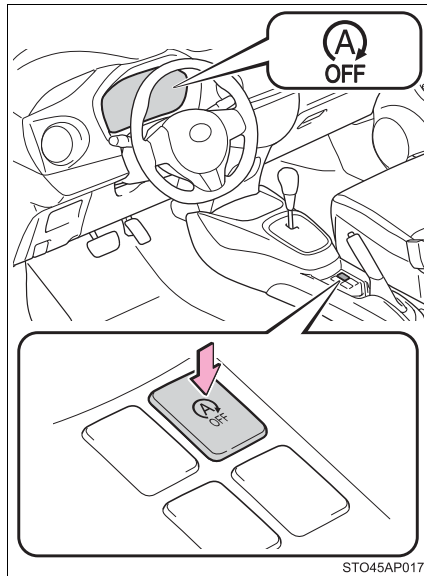

STO45AP017

■ If the Stop & Start cancel switch is pressed while the vehicle is stopped

- When the engine is stopped by the Stop & Start system, pressing the Stop & Start cancel switch will restart the engine.
From the next time the vehicle is stopped (after Stop & Start system has been turned off), the engine will not be stopped.
 - With the Stop & Start system disabled, pressing the Stop & Start cancel switch will re-enable the system but not stop the engine.
From the next time the vehicle is stopped (after Stop & Start system has been turned on), the engine will be stopped.
-

■ Operating conditions

- The Stop & Start system is operational when all of the following conditions are met:
 - The engine is adequately warmed up.
 - The battery is sufficiently charged.
 - The driver's door is closed.
 - The driver's seat belt is fastened.
 - The hood is closed.
 - The accelerator pedal is not being depressed.
 - Vehicles with a Multidrive: The brake pedal is firmly depressed.
 - Vehicles with a Multidrive: The shift lever is not in R.
 - Vehicles with a manual transmission: The clutch pedal is not being depressed.
 - Vehicles with a manual transmission: The shift lever is in N.
- In the following circumstances the engine may not be stopped by the Stop & Start system. This is not a malfunction of the Stop & Start system.
 - Engine coolant temperature or transmission fluid temperature is too low or too high.
 - The outside temperature is extremely low.
 - The air conditioning system is being used when the outside temperature is high or low.
 - The air conditioning system is being used when the vehicle interior temperature is extremely high such as after the vehicle was parked under the hot sun.
 - Vehicles with an automatic air conditioning system: The windshield defogger is being used.
 - The battery is not sufficiently charged, or is undergoing a periodic recharge.
 - Due to traffic or other circumstances the vehicle is stopped repeatedly, resulting in the amount of time the engine is stopped by the Stop & Start system to become excessively high.

- The driver's seat belt is unfastened.
- The driver's door is opened.
- The hood is opened.
- The vehicle is stopped on a steep hill.
- The brake booster vacuum is low.
- A large amount of electricity is being used.
- At high altitude.

When the above conditions improve, the Stop & Start system will stop and restart the engine from the next time the vehicle is stopped.

- In the following situations, the engine may start even without the brake pedal being released (Multidrive) or clutch pedal being depressed (manual transmission).
 - The brake pedal is pumped or strongly depressed.
 - The air conditioning system is being used or turned on.
 - Vehicles with an automatic air conditioning system: The windshield defogger is turned on.
 - The battery is not sufficiently charged.
 - The vehicle starts to roll on an incline.
 - Vehicles with a Multidrive: The hood is opened when the shift lever is in N or P.
 - Vehicles with a Multidrive: The shift lever is shifted into a position other than N or P.
 - The accelerator pedal is depressed.
 - A large amount of electricity is being used.
 - The driver's door is opened.
 - The driver's seat belt is unfastened.
- In the following situations, it may take longer than normal for the Stop & Start system to activate.
 - The battery is discharged.
 - After the battery terminals have been disconnected and reconnected after a battery replacement, etc.
 - The engine coolant temperature is low.

■ Automatic reactivation of the Stop & Start system

▶ Vehicles without a smart entry & start system

Even if the Stop & Start system is disabled by the Stop & Start cancel switch, it will be automatically re-enabled once the engine switch is turned to the "LOCK" position then to the "START" position.

▶ Vehicles with a smart entry & start system

Even if the Stop & Start system is disabled by the Stop & Start cancel switch, it will be automatically re-enabled once the engine switch is turned off then the engine is started.

■ The Stop & Start system protection feature

▶ Vehicles without a smart entry & start system

When an excessively loud sound is being projected by the audio system, the audio system may be automatically cut off in order to maintain power for the Stop & Start system function.

If this occurs, turning the engine switch to the “LOCK” position then to the “ACC” or “ON” position re-enables the audio system.

▶ Vehicles with a smart entry & start system

When an excessively loud sound is being projected by the audio system, the audio system may be automatically cut off in order to maintain power for the Stop & Start system function.

If this occurs, turning the engine switch off then to ACCESSORY mode or IGNITION ON mode re-enables the audio system.

■ Hood

If the hood is opened while the engine is stopped by the Stop & Start system, the engine cannot be restarted by the Stop & Start system or by the automatic engine start function. Restart the engine with the engine switch operation. (→P. 182, 185)

Vehicles with a Multidrive: If the hood is opened while the engine is stopped by the Stop & Start system and the shift lever is in N or P, the engine will restart.

■ When to use the Stop & Start system

Use the Stop & Start system when stopping the vehicle temporarily at red lights, intersections, etc. When stopping the vehicle for a longer period of time, turn off the engine completely.

■ Stop & Start system warning buzzer

If the engine is stopped by the Stop & Start system and either of the following actions is performed, a buzzer will sound and the Stop & Start indicator will flash (Multidrive), or a buzzer will sound (manual transmission). This indicates that the engine is only stopped by the Stop & Start system, not that the engine has been turned off completely.

▶ Vehicles with a Multidrive

The driver's door is opened when the shift lever is in D or M.

▶ Vehicles with a manual transmission

The shift lever is shifted into a position other than N with the clutch pedal released.

■ **If the Stop & Start cancel indicator light continues to flash**

The Stop & Start system may be malfunctioning. Contact any authorized Toyota dealer or repairer, or another duly qualified and equipped professional.

■ **If the windshield is fogged up while the engine is stopped by the Stop & Start system**

▶ Vehicles with an automatic air conditioning system

Turn the windshield defogger on. (The engine will start due to the automatic engine start function.) (→P. 291)

▶ Vehicles with a manual air conditioning system

Vehicles with a Multidrive:

Restart the engine by releasing the brake pedal (when the shift lever is in D or M) or depress the brake pedal and shift the shift lever to D or M (when the shift lever is in N or P) (→P. 229), or by pressing the Stop & Start cancel switch, and then set the air outlet selector dial to . (→P. 282)

Vehicles with a manual transmission:

Restart the engine by depressing the clutch pedal (→P. 229), or by pressing the Stop & Start cancel switch, and then set the air outlet selector dial to . (→P. 282)

If the windshield fogs up frequently, press the Stop & Start cancel switch to deactivate the system.

■ **The Stop & Start system operation time and Stop & Start system total operation time display**

→P. 92

■ **Replacing battery**

The installed battery is specific to the Stop & Start system. It should only be replaced with a battery of identical type and rating.

Ask any authorized Toyota dealer or repairer, or another duly qualified and equipped professional for further details.

**WARNING****■ When the Stop & Start system is operating**

- Keep the shift lever in N (manual transmission) and apply the brake pedal or parking brake for safety while the engine is stopped due to the Stop & Start system (while the Stop & Start indicator is on).
Unexpected accidents may occur due to the automatic engine start function.
- Do not leave the vehicle while the engine is stopped due to the Stop & Start system (while the Stop & Start indicator is on).
Unexpected accidents may occur due to the automatic engine start function.
- Ensure that the engine is not stopped by the Stop & Start system while the vehicle is in a poorly ventilated area. The engine may restart due to the automatic engine start function, causing exhaust gases to collect and enter the vehicle and resulting in death or a serious health hazard.

**NOTICE****■ To ensure the system operates correctly**

If any one of the following situations occurs, the Stop & Start system may not operate correctly, thus, please have your vehicle checked by any authorized Toyota dealer or repairer, or another duly qualified and equipped professional.

- While the driver's seat belt is fastened, the driver's and front passenger's seat belt reminder light flashes.
- Even when the driver's seat belt is not fastened, the driver's and front passenger's seat belt reminder light remains off.
- Even when the driver's door is closed, the open door warning light comes on, or the interior light comes on when the interior light switch is in the door position.
- Even when the driver's door is opened, the open door warning light does not come on, or the interior light does not come on when the interior light switch is in the door position.

Driving assist systems

To help enhance driving safety and performance, the following systems operate automatically in response to various driving situations. Be aware, however, that these systems are supplementary and should not be relied upon too heavily when operating the vehicle.

◆ **ABS (Anti-lock Brake System)**

Helps to prevent wheel lock when the brakes are applied suddenly, or if the brakes are applied while driving on a slippery road surface

◆ **Brake assist**

Generates an increased level of braking force after the brake pedal is depressed when the system detects a panic stop situation

◆ **VSC (Vehicle Stability Control) (if equipped)**

Helps the driver to control skidding when swerving suddenly or turning on slippery road surfaces

◆ **TRC (Traction Control) (if equipped)**

Helps to maintain drive power and prevent the drive wheels from spinning when starting the vehicle or accelerating on slippery roads

◆ **EPS (Electric Power Steering)**

Employs an electric motor to reduce the amount of effort needed to turn the steering wheel

◆ **Emergency brake signal**

When the brakes are applied suddenly, the emergency flashers automatically flash to alert the vehicle behind.

When the TRC/VSC systems are operating

The slip indicator light will flash while the TRC/VSC systems are operating.

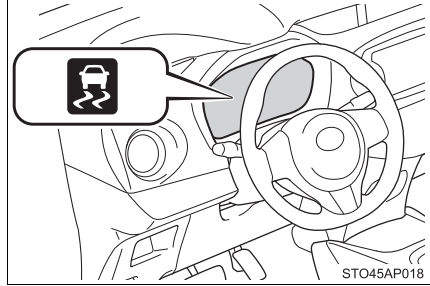

Disabling the TRC systems

If the vehicle gets stuck in mud, dirt or snow, the TRC system may reduce power from the engine to the wheels. Pressing VSC OFF switch to turn the system off may make it easier for you to rock the vehicle in order to free it.

To turn the TRC system off, quickly press and release the VSC OFF switch.

The "TRC OFF" indicator light will come on.

Press the switch again to turn the system back on.

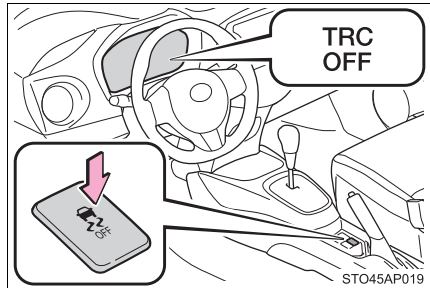

■ Turning off both TRC and VSC systems

To turn TRC and VSC systems off, press and hold the VSC OFF switch for more than 3 seconds while the vehicle is stopped.

The “TRC OFF” indicator light and the VSC OFF indicator light will come on. Press the switch again to turn the systems back on.

■ When the “TRC OFF” indicator light comes on even if the VSC OFF switch has not been pressed

TRC cannot be operated. Contact any authorized Toyota dealer or repairer, or another duly qualified and equipped professional.

■ Sounds and vibrations caused by the ABS, brake assist, TRC and VSC systems

- A sound may be heard from the engine compartment when the brake pedal is depressed repeatedly, when the engine is started or just after the vehicle begins to move. This sound does not indicate that a malfunction has occurred in any of these systems.
- Any of the following conditions may occur when the above systems are operating. None of these indicates that a malfunction has occurred.
 - Vibrations may be felt through the vehicle body and steering.
 - A motor sound may be heard after the vehicle comes to a stop.
 - The brake pedal may pulsate slightly after the ABS is activated.
 - The brake pedal may move down slightly after the ABS is activated.

■ EPS operation sound

When the steering wheel is operated, a motor sound (whirring sound) may be heard. This does not indicate a malfunction.

■ Automatic reactivation of TRC and VSC systems

After turning the TRC and VSC systems off, the systems will be automatically re-enabled in the following situations:

- When the engine switch is turned to the “LOCK” position
- If only the TRC system is turned off, the TRC will turn on when vehicle speed increases
If both the TRC and VSC systems are turned off, automatic re-enabling will not occur when vehicle speed increases.

■ Reduced effectiveness of the EPS system

The effectiveness of the EPS system is reduced to prevent the system from overheating when there is frequent steering input over an extended period of time. The steering wheel may feel heavy as a result. Should this occur, refrain from excessive steering input or stop the vehicle and turn the engine off. The EPS system should return to normal within 10 minutes.

■ Operating conditions of emergency brake signal

When the following three conditions are met, the emergency brake signal will operate:

- The emergency flashers are off.
- Actual vehicle speed is over 55 km/h (35 mph).
- The brake pedal is depressed in a manner that cause the system to judge from the vehicle deceleration that this is a sudden braking operation.

■ Automatic system cancelation of emergency brake signal

The emergency brake signal will turn off in any of the following situations:

- The emergency flashers are turned on.
- The brake pedal is released.
- The system judges from the vehicle deceleration that is not a sudden braking operation.

**WARNING****■ The ABS does not operate effectively when**

- The limits of tire gripping performance have been exceeded (such as excessively worn tires on a snow covered road).
- The vehicle hydroplanes while driving at high speed on wet or slick roads.

■ Stopping distance when the ABS is operating may exceed that of normal conditions

The ABS is not designed to shorten the vehicle's stopping distance. Always maintain a safe distance from the vehicle in front of you, especially in the following situations:

- When driving on dirt, gravel or snow-covered roads
- When driving with tire chains
- When driving over bumps in the road
- When driving over roads with potholes or roads with uneven surfaces

■ TRC may not operate effectively when

Directional control and power may not be achievable while driving on slippery road surfaces, even if the TRC system is operating.

Drive the vehicle carefully in conditions where stability and power may be lost.

 **WARNING****■ When the VSC is activated**

The slip indicator light flashes. Always drive carefully. Reckless driving may cause an accident. Exercise particular care when the indicator light flashes.

■ When the TRC/VSC systems are turned off

Be especially careful and drive at a speed appropriate to the road conditions. As these are the systems to help ensure vehicle stability and driving force, do not turn the TRC/VSC systems off unless unnecessary.

■ Replacing tires

Make sure that all tires are of the specified size, brand, tread pattern and total load capacity. In addition, make sure that the tires are inflated to the recommended tire inflation pressure level.

The ABS, TRC and VSC systems will not function correctly if different tires are installed on the vehicle.

Contact any authorized Toyota dealer or repairer, or another duly qualified and equipped professional for further information when replacing tires or wheels.

■ Handling of tires and the suspension

Using tires with any kind of problem or modifying the suspension will affect the driving assist systems, and may cause a system to malfunction.

Diesel particulate filter system*

When the deposit collected by the filter reaches a predetermined amount, it is automatically cleaned.

Cleaning the DPF catalytic converter

Cleaning the DPF catalytic converter is performed as necessary in accordance with driving conditions.

Equipment characteristics

The DPF system has the following characteristics:

- Idle speed increases during cleaning
- The smell of the exhaust gas changes
- When starting the engine, white-colored steam (water vapor) may be expelled during cleaning
- Acceleration performance may degrade during cleaning

■ Replacing the engine oil

→P. 335

 **WARNING****■ Exhaust pipe**

Do not touch the exhaust pipe during cleaning, as the exhaust pipe and exhaust gases will become particularly hot. Also, make sure that there are no people or flammable materials near the exhaust pipe while the vehicle is stopped.

Failure to do so may cause injury by burning or a fire.

 **NOTICE****■ To prevent the DPF system from failing**

- Do not use fuel other than the specified type
- Do not use engine oil other than the recommended type
- Do not modify the exhaust pipe

Winter driving tips

Carry out the necessary preparations and inspections before driving the vehicle in winter. Always drive the vehicle in a manner appropriate to the prevailing weather conditions.

Preparation for winter

- Use fluids that are appropriate to the prevailing outside temperatures.
 - Engine oil
 - Engine coolant
 - Washer fluid
- Have a service technician inspect the condition of the battery.
- Have the vehicle fitted with four snow tires or purchase a set of tire chains for the front tires.

Ensure that all tires are the same size and brand, and that their wear level is not noticeably different with each other. Also make sure that chains match the size of the tires.

Before driving the vehicle

Perform the following according to the driving conditions:

- Do not try to forcibly open a window or move a wiper that is frozen. Pour warm water over the frozen area to melt the ice. Wipe away the water immediately to prevent it from freezing.
- To ensure proper operation of the climate control system fan, remove any snow that has accumulated on the air inlet vents in front of the windshield.
- Check for and remove any excess ice or snow that may have accumulated on the exterior lights, vehicle's roof, chassis, around the tires or on the brakes.
- Remove any snow or mud from the bottom of your shoes before getting in the vehicle.

When driving the vehicle

Accelerate the vehicle slowly, keep a safe distance between you and the vehicle ahead, and drive at a reduced speed suitable to road conditions.

When parking the vehicle

Park the vehicle and move the shift lever to P (Multidrive) 1 or R (manual transmission) without setting the parking brake. The parking brake may freeze up, preventing it from being released. If necessary, block the wheels to prevent inadvertent sliding or creeping.

Selecting tire chains

Use the correct tire chain size when mounting the tire chains. Chain size is regulated for each tire size.

- ① Side chain
 - Except 175/65R14 tires:
3 mm (0.12 in.) in diameter
 - 175/65R14 tires:
4 mm (0.16 in.) in diameter
- ② Cross chain
 - Except 175/65R14 tires:
4 mm (0.16 in.) in diameter
 - 175/65R14 tires:
5 mm (0.20 in.) in diameter

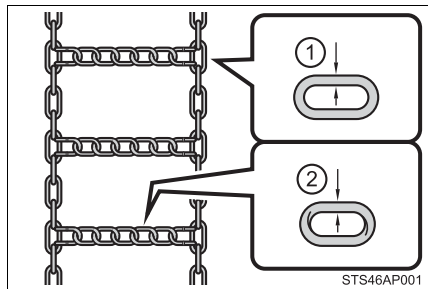

Regulations on the use of tire chains

Regulations regarding the use of tire chains vary depending on location and type of road. Always check local regulations before installing chains.

■ Tire chain installation

Observe the following precautions when installing and removing chains:

- Install and remove tire chains in a safe location.
- Install tire chains on the front tires only. Do not install tire chains on the rear tires.
- Install tire chains on front tires as tightly as possible. Retighten chains after driving 0.5 — 1.0 km (1/4 — 1/2 mile).
- Install tire chains following the instructions provided with the tire chains.
- If wheel ornaments are used, they will be scratched by the chain band, so remove the ornaments before putting on the chains. (→P. 423)



WARNING

■ Driving with snow tires

Observe the following precautions to reduce the risk of accidents.

Failure to do so may result in a loss of vehicle control and cause death or serious injury.

- Use tires of the specified size.
- Maintain the recommended level of air pressure.
- Do not drive at speeds in excess of the speed limit or the speed limit specified for the snow tires being used.
- Use snow tires on all, not just some wheels.
- Do not use tires of noticeably different wear level.

■ Driving with tire chains

Observe the following precautions to reduce the risk of accidents.

Failure to do so may result in the vehicle being unable to be driven safely, and may cause death or serious injury.

- Do not drive in excess of the speed limit specified for the tire chains being used, or 50 km/h (30 mph), whichever is lower.
- Avoid driving on bumpy road surfaces or over potholes.
- Avoid sudden acceleration, abrupt steering, sudden braking and shifting operations that cause sudden engine braking.
- Slow down sufficiently before entering a curve to ensure that vehicle control is maintained.

Audio system**5****5-1. Basic Operations**

- Audio system types.....246
- Steering wheel audio
switches.....248
- USB port249

5-2. Using the audio system

- Optimal use of the audio
system250

5-3. Using the radio

- Radio operation252

**5-4. Playing audio CDs and
MP3/WMA discs**

- CD player operation.....257

5-5. Using an external device

- Listening to an iPod266
- Listening to a USB
memory device273

Audio system types*

► Vehicles with a Navigation/Multimedia system

Owners of models equipped with a Navigation/Multimedia system should refer to the “Navigation and multimedia system Owner’s Manual”.

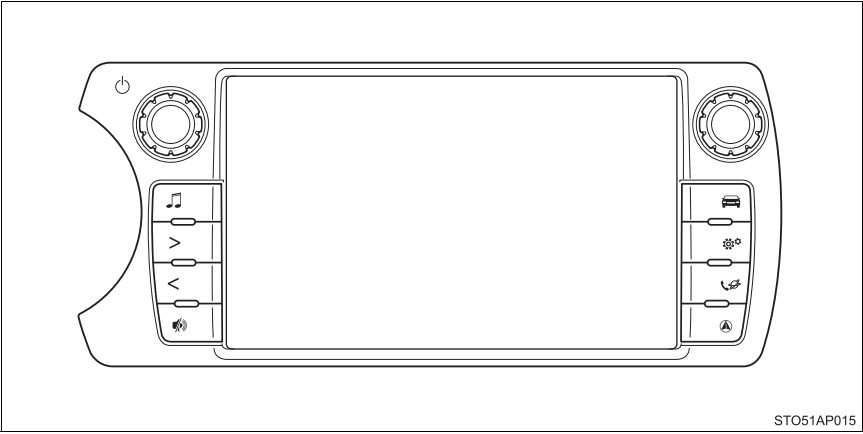

*: If equipped

► Vehicles without a Navigation/Multimedia system

CD player and AM/FM radio

The illustration below is for left-hand drive vehicles. Some button positions are reversed for right-hand drive vehicles.

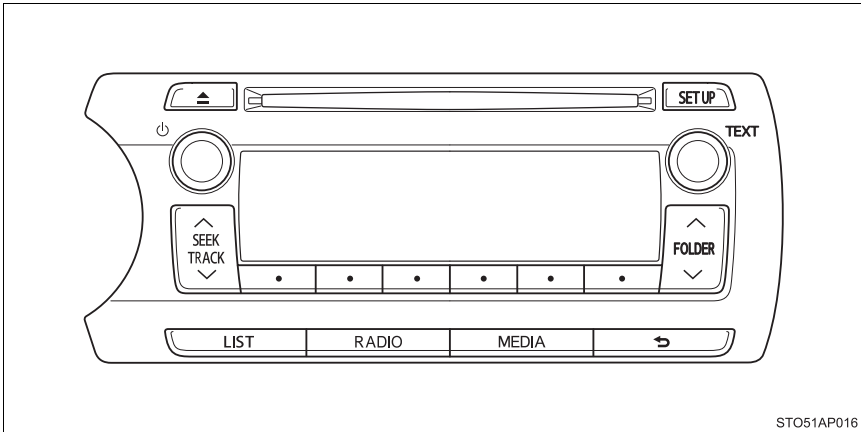

■ **Using cellular phones**

Interference may be heard through the audio system's speakers if a cellular phone is being used inside or close to the vehicle while the audio system is operating.

 **NOTICE**

■ **To prevent battery discharge**

Do not leave the audio system on longer than necessary when the engine is stopped.

■ **To avoid damaging the audio system**

Take care not to spill drinks or other fluids over the audio system.

Steering wheel audio switches*

Some audio features can be controlled using the switches on the steering wheel.

Operation may differ depending on the type of audio system or navigation system. For details, refer to the manual provided with the audio system or navigation system.

Operating the audio system using the steering wheel switches

- ① Volume switch:
- Press: Increases/decreases volume
 - Press and hold: Continuously increases/decreases volume

- ② Radio mode:
- Press: Selects a radio station
 - Press and hold: Seeks up/down

CD, MP3/WMA disc, iPod or USB mode:

- Press: Selects a track/file/song
- Press and hold: Selects a folder or album (MP3/WMA disc, iPod or USB)

- ③ “MODE” switch
- Press: Turns the power on, selects an audio source
 - Press and hold: Mutes or pauses the current operation.
To cancel the mute or pause, press and hold again.

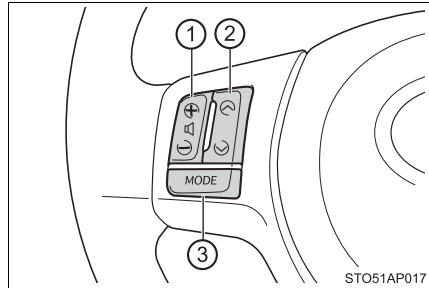

WARNING

■ To reduce the risk of an accident

Exercise care when operating the audio switches on the steering wheel.

USB port*

Connect an iPod, USB memory device or portable audio player to the USB port as indicated below. Press  to select “iPod” or “USB”.

Connecting using the USB port

■ iPod

Open the cover and connect an iPod using an iPod cable.

Turn on the power of the iPod if it is not turned on.

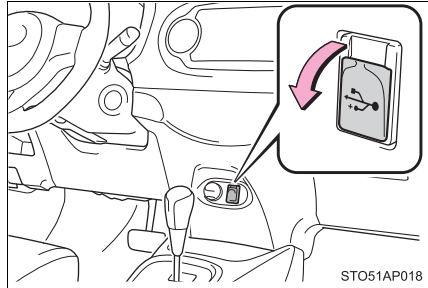

■ USB memory device

Open the cover and connect the USB memory device.

Turn on the power of the USB memory device if it is not turned on.

■ Portable audio player

Open the cover and connect the portable audio player.

Turn on the power of the portable audio player if it is not turned on.

WARNING

■ While driving

Do not connect a device or operate the device controls.

Optimal use of the audio system*



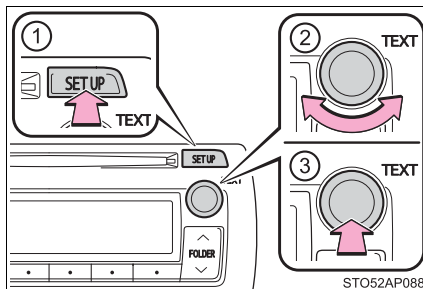

Sound quality (treble/bass) and volume balance can be adjusted.

- ① Displays the current mode
- ② Changes the following setting
 - Sound quality and volume balance (→P. 251)
The sound quality and balance setting can be changed to produce the best sound.
 - Automatic Sound Levelizer on/off (→P. 251)
- ③ Selecting the mode



Using the audio control function

■ Changing sound quality modes

- 1 Press  .
- 2 Turn  to select “Sound Setting”.
- 3 Press  .
- 4 Turn  as corresponds to the desired mode.
“BASS”, “TREBLE”, “FADER”, “BALANCE”, or “ASL”
- 5 Press  .

■ Adjusting sound quality

Turning  adjusts the level.

Sound quality mode	Mode displayed	Level	Turn to the left	Turn to the right
Bass*	"BASS"	-5 to 5	Low	High
Treble*	"TREBLE"	-5 to 5		
Front/rear volume balance	"FADER"	R7 to F7	Shifts to rear	Shifts to front
Left/right volume balance	"BALANCE"	L7 to R7	Shifts to left	Shifts to right

*: The sound quality level is adjusted individually in each audio mode.

■ Adjusting the Automatic Sound Levelizer (ASL)

When ASL is selected, turning  to the right changes the amount of ASL in the order of LOW, MID and HIGH.

Turning  to the left turns ASL off.

ASL automatically adjusts the volume and tone quality according to vehicle speed.

Radio operation*

Select “AM” or “FM” to begin listening to the radio.

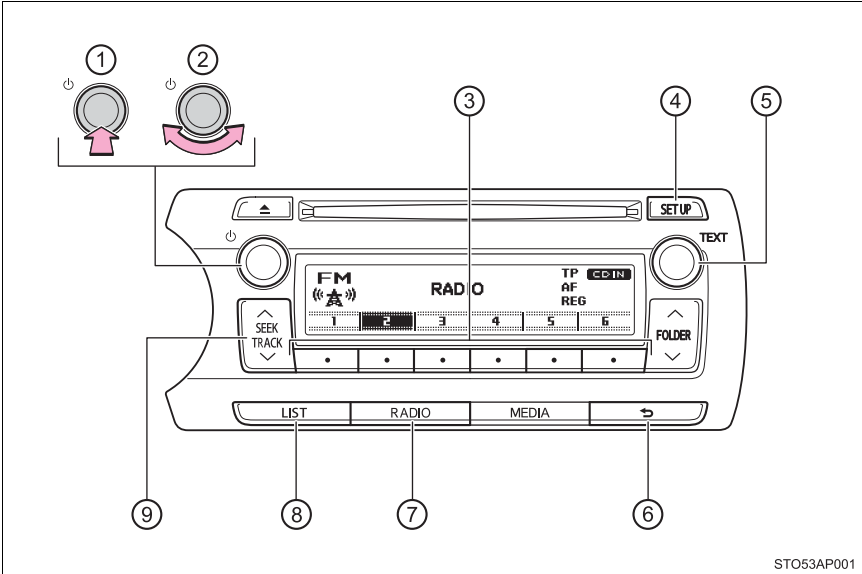





STO53AP001

- ① Power
- ② Volume
- ③ Station selector
- ④ AF/region code/
TA mode setup
- ⑤ Adjusting the frequency or
selecting items
- ⑥ Back button
- ⑦ AM/FM mode button
- ⑧ Displays station list
- ⑨ Seeking the frequency

*: If equipped

Setting station presets

- 1 Search for a desired station by turning  or pressing “^” or “v” on  .
- 2 Press and hold the button (from  [1] to  [6]) the station is to be set to until you hear a beep.

Using the station list

■ Updating the station list

- 1 Press  .

The station list will be displayed.

- 2 Press  (UPDATE) to update the list.

“Updating” is displayed while the searching is in process, and then available stations will be listed on the display.

To cancel the updating process, press  .

■ Selecting a station from the station list

- 1 Press  .

The station list will be displayed.

- 2 Turn  to select a station.





- 3 Press  to tune in the station.

To return to the previous display, press  .

RDS (Radio Data System)

This feature allows your radio to receive station.





■ Listening to stations of the same network

- 1 Press  .
- 2 Turn  to “RADIO” and press  .
- 3 Turn  as corresponds to the desired mode: “FM AF” or “Region code”.
- 4 Press  to select “ON” or “OFF”.

FM AF ON mode: The station among those of the same network with strong reception is selected.

Region code ON mode: The station among those of the same network with strong reception and broadcasting the same program is selected.

■ Traffic information

- 1 Press  .
- 2 Turn  to “RADIO” and press  .
- 3 Turn  to “FM TA” mode.
- 4 Press  to select “ON” or “OFF”.

TP mode: The system automatically switches to traffic information when a broadcast with a traffic information signal is received.

The station returns to the previous one when the traffic information ends.

TA mode: The system automatically switches to traffic information when a broadcast with a traffic information signal is received. In FM modes, the system will be mute unless traffic information is being broadcast.

The audio system returns to the previous mode when the traffic information ends.

■ **EON (Enhanced Other Network) system (for traffic announcement function)**

If the RDS station (with EON data) you are listening to is not broadcasting a traffic information program and the audio system is in the TA (traffic announcement) mode, the radio will be switched automatically to a station broadcasting a traffic information program in the EON AF list when traffic information begins.

■ **When the battery is disconnected**

Stations presets are erased.

■ **Reception sensitivity**

- Maintaining perfect radio reception at all times is difficult due to the continually changing position of the antenna, differences in signal strength and surrounding objects, such as trains, transmitters, etc.
- The radio antenna is mounted on the rear roof. The antenna can be removed from the base by turning it.

■ **Digital Audio Broadcast (DAB) radio**

The optional radio antenna and tuner are necessary for the use of Digital Audio Broadcast (DAB) radio.



NOTICE

■ **To prevent damage, remove the antenna in the following cases**

- The antenna will touch the ceiling of a garage.
- A cover will be put on the roof.

CD player operation*

Insert a disc or press  to beginning to a disc.

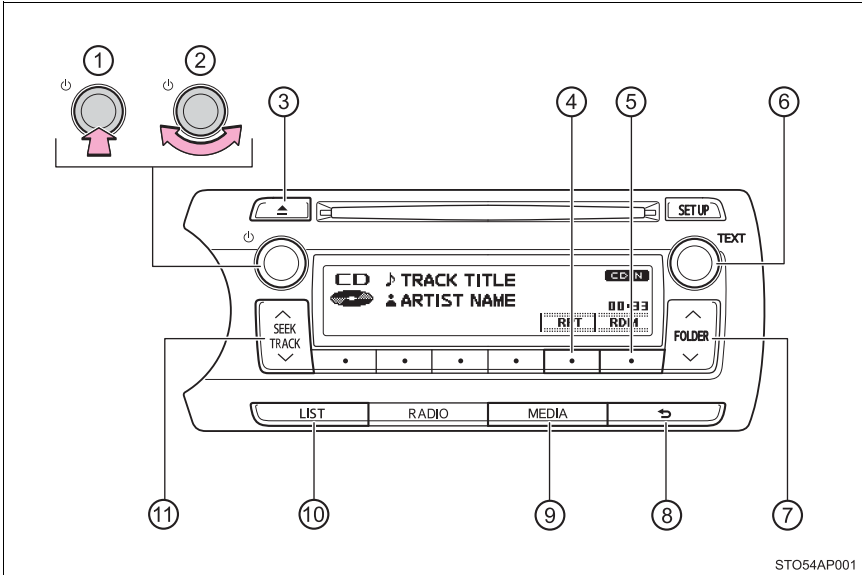

- | | |
|---|---|
| ① Power | ⑦ Selecting a folder |
| ② Volume | ⑧ Back button |
| ③ Disc eject | ⑨ Playback |
| ④ Repeat play | ⑩ Displays track/folder list |
| ⑤ Random playback | ⑪ Selecting a track, fast-forwarding or reversing |
| ⑥ Selecting a track/file or displays text message | |

Loading CDs or MP3 and WMA discs



Insert a disc.

Ejecting CDs or MP3 and WMA discs

Press  and remove the disc.

Using the CD player

■ Selecting a track

Turn  or press “^” to move up or “v” to move down using  until the desired track number is displayed.

■ Selecting a track from a track list

1 Press .

The track list will be displayed.

2 Turn and press  to select a track.

To return to the previous display, press  or .

■ Fast-forwarding and reversing tracks

To fast-forward or reverse, press and hold “^” or “v” on .

■ Repeat play

Press  (RPT).

The current track is played repeatedly until  (RPT) is pressed again.

■ Random playback

Press  (RDM).

Tracks are played in a random order until  (RDM) is pressed again.

■ Switching the display

Press .

Track title, Artist name and CD title are shown on the display.

To return to the previous display, press  or .

Playing back MP3 and WMA discs

■ Selecting a folders one at a time

Press “^” or “v” on  to select the desired folder.

■ Selecting a folder and file from folder list

1 Press  .

The folder list will be displayed.

2 Turn and press  to select a folder and a file.



To return to the previous display, press  .

To exit, press  .

■ Returning to the first folder

Press and hold “v” on  until you hear a beep.

■ Selecting files

Turn  or press “^” or “v” on  to select the desired file.

■ Fast-forwarding and reversing files

To fast-forward or reverse, press and hold “^” or “v” on  .

■ Repeat play

Pressing  (RPT) changes modes in the following order:

File repeat → Folder repeat* → Off.



*: Available except when RDM (random playback) is selected

■ Random playback

Pressing  (RDM) changes modes in the following order:

Folder random → Disc random → Off.



■ Switching the display

Press  .

Track title, Artist name and Album title (MP3 only) are shown on the display.

To return to the previous display, press  or  .

■ Display

Up to 24 characters can be displayed.

Depending on the contents recorded, the characters may not be displayed properly or may not be displayed at all.

■ Error messages

If an error message is displayed, refer to the following table and take the appropriate measures. If the problem is not rectified, take the vehicle to any authorized Toyota dealer or repairer, or another duly qualified and equipped professional.

Message	Cause	Correction procedures
"CD CHECK"	<ul style="list-style-type: none"> • The disc is dirty or damaged. • The disc is inserted upside down. 	<ul style="list-style-type: none"> • Clean the disc. • Insert the disc correctly.
"ERROR"	There is a malfunction within the system.	Eject the disc.
"WAIT"	Operation has stopped due to a high temperature inside the player.	Wait for a while and then press  . Contact any authorized Toyota dealer or repairer, or another duly qualified and equipped professional if the CD still cannot be played.
"NO SUPPORT"	MP3/WMA files are not included on the CD.	Eject the disc.

■ Discs that can be used

Discs with the marks shown below can be used. Playback may not be possible depending on recording format or disc features, or due to scratches, dirt or deterioration.



CDs with copy-protect features may not be used.

■ CD player protection feature

To protect the internal components, playback is automatically stopped when a problem is detected while the CD player is being used.

■ If a disc is left inside the CD player or in the ejected position for extended periods

The disc may be damaged and may not play properly.

■ Lens cleaners

Do not use lens cleaners. Doing so may damage the CD player.

■ MP3 and WMA files

MP3 (MPEG Audio LAYER3) is a Microsoft audio compression format.

Files can be compressed to approximately 1/10 of their original size by using MP3 compression.

WMA (Windows Media Audio) is a Microsoft audio compression format.

This format compresses audio data to a size smaller than that of the MP3 format.

There is a limit to the MP3 and WMA file standards and to the media/formats recorded by them that can be used.

● MP3 file compatibility

- Compatible standards
MP3 (MPEG1 LAYER3, MPEG2 LSF LAYER3)
- Compatible sampling frequencies
MPEG1 LAYER3: 32, 44.1, 48 (kHz)
MPEG2 LSF LAYER3: 16, 22.05, 24 (kHz)
- Compatible bit rates (compatible with VBR)
MPEG1 LAYER3: 64, 80, 96, 112, 128, 160, 192, 224, 256, 320 (kbps)
MPEG2 LSF LAYER3: 64, 80, 96, 112, 128, 144, 160 (kbps)
- Compatible channel modes: stereo, joint stereo, dual channel and monaural

- WMA file compatibility

- Compatible standards
WMA Ver. 7, 8, 9
- Compatible sampling frequencies
32, 44.1, 48 (kHz)
- Compatible bit rates (only compatible with 2-channel playback)
Ver. 7, 8: CBR 48, 64, 80, 96, 128, 160, 192 (kbps)
Ver. 9: CBR 48, 64, 80, 96, 128, 160, 192, 256, 320 (kbps)

- Compatible media

Media that can be used for MP3 and WMA playback are CD-Rs and CD-RWs.

Playback in some instances may not be possible, depending on the status of the CD-R or CD-RW. Playback may not be possible or the audio may jump if the disc is scratched or marked with fingerprints.

- Compatible disc formats

The following disc formats can be used.

- Disc formats: CD-ROM Mode 1 and Mode 2
CD-ROM XA Mode 2, Form 1 and Form 2
- File formats: ISO9660 Level 1, Level 2, (Romeo, Joliet)
MP3 and WMA files written in any format other than those listed above may not play correctly, and their file names and folder names may not be displayed correctly.

Items related to standards and limitations are as follows.

- Maximum directory hierarchy: 8 levels
- Maximum length of folder names/file names: 32 characters
- Maximum number of folders: 192 (including the root)
- Maximum number of files per disc: 255

- File names

The only files that can be recognized as MP3/WMA and played are those with the extension .mp3 or .wma.

- Multi-sessions

As the audio system is compatible with multi-sessions, it is possible to play discs that contain MP3 and WMA files. However, only the first session can be played.

- ID3 and WMA tags

ID3 tags can be added to MP3 files, making it possible to record the track title, artist name, etc.

The system is compatible with ID3 Ver. 1.0, 1.1, and Ver. 2.2, 2.3 ID3 tags. (The number of characters is based on ID3 Ver. 1.0 and 1.1.)

WMA tags can be added to WMA files, making it possible to record the track title and artist name in the same way as with ID3 tags.

- MP3 and WMA playback

When a disc containing MP3 or WMA files is inserted, all files on the disc are first checked. Once the file check is finished, the first MP3 or WMA file is played. To make the file check finish more quickly, we recommend you do not write in any files other than MP3 or WMA files or create any unnecessary folders.

If the discs contain a mixture of music data and MP3 or WMA format data, only music data can be played.

- Extensions

If the file extensions .mp3 and .wma are used for files other than MP3 and WMA files, they will be mistakenly recognized and played as MP3 and WMA files. This may result in large amounts of interference and damage to the speakers.

- Playback

- To play MP3 files with steady sound quality, we recommend a fixed bit rate of 128 kbps and a sampling frequency of 44.1 kHz.
- CD-R or CD-RW playback may not be possible in some instances, depending on the characteristics of the disc.
- There is a wide variety of freeware and other encoding software for MP3 and WMA files on the market, and depending on the status of the encoding and the file format, poor sound quality or noise at the start of playback may result. In some cases, playback may not be possible at all.
- When files other than MP3 or WMA files are recorded on a disc, it may take more time to recognize the disc and in some cases, playback may not be possible at all.
- Microsoft, Windows, and Windows Media are the registered trademarks of Microsoft Corporation in the U.S. and other countries.

**WARNING****■ Certification for the CD player**

This product is a class I laser product.

- Do not open the cover of the player or attempt to repair the unit yourself. Refer servicing to qualified personnel.
- Laser power: No hazardous

 NOTICE

■ **Discs and adapters that cannot be used**

Do not use the following types of discs.

Also, do not use 8 cm (3 in.) disc adapters, Dual Discs or printable discs. Doing so may damage the player and/or the disc insert/eject function.

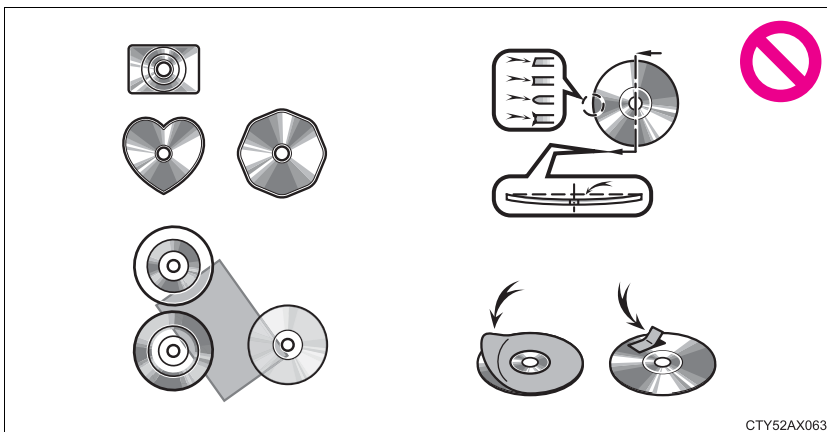

- Discs that have a diameter that is not 12 cm (4.7 in.).
- Low-quality or deformed discs.
- Discs with a transparent or translucent recording area.
- Discs that have had tape, stickers or CD-R labels attached to them, or that have had the label peeled off.

■ **Player precautions**

Failure to follow the precautions below may result in serious damage to the discs or the player itself.

- Do not insert anything other than discs into the disc slot.
- Do not apply oil to the player.
- Store discs away from direct sunlight.
- Never try to disassemble any part of the player.

Listening to an iPod*

Connecting an iPod enables you to enjoy music from the vehicle speakers. Press  until "iPod" is displayed.

Connecting an iPod

→P. 249

Control panel

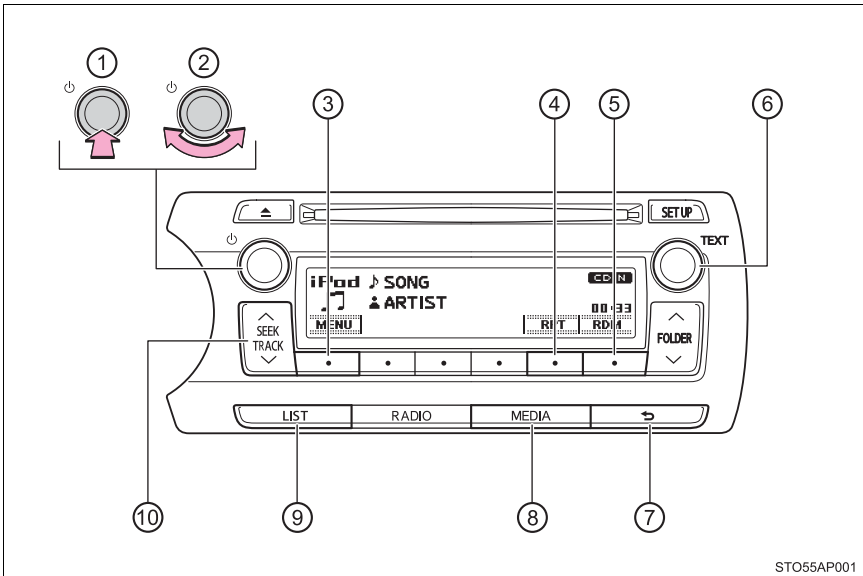



STO55AP001

- ① Power
- ② Volume
- ③ iPod menu mode
- ④ Repeat play
- ⑤ Shuffle playback
- ⑥ Selecting an iPod menu/song or displays text message
- ⑦ Back button
- ⑧ Playback
- ⑨ Displays songs list
- ⑩ Selecting a song, fast-forwarding or reversing

*: If equipped

Selecting a play mode

- 1 Press  (MENU) to select iPod menu mode.
- 2 Turning  clockwise changes the play mode in the following order:
 “Playlists” → “Artists” → “Albums” → “Songs” → “Podcasts” →
 “Genres” → “Composers” → “Audiobooks”
- 3 Press  to select the desired play mode.

■ Play mode list

Play mode	First selection	Second selection	Third selection	Fourth section
“Playlists”	Playlists select	Songs select	-	-
“Artists”	Artists select	Albums select	Songs select	-
“Albums”	Albums select	Songs select	-	-
“Songs”	Songs select	-	-	-
“Podcasts”	Podcasts select	Episodes select	-	-
“Genres”	Genre select	Artists select	Albums select	Songs select
“Composers”	Composers select	Albums select	Songs select	-
“Audiobooks”	Audiobooks select	-	-	-

■ Selecting a list

1 Turn  to display the first selection list.

2 Press  to select the desired item.

Pressing the knob changes to the second selection list.

3 Repeat the same procedure to select the desired item.

To return to the previous selection list, press .

Selecting songs

Turn  or press “^” or “v” on  to select the desired song.

Selecting a song from the song list

1 Press .

The song list will be displayed.

2 Turn  to select a song.

3 Press  to play the song.

To return to the previous display, press .

Fast-forwarding and reversing songs

To fast-forward or reverse, press and hold “^” or “v” on .

Repeat play

Press  (RPT).

To cancel, press  (RPT) again.

Shuffle playback

Pressing  (RDM) changes modes in the following order:
Track shuffle → Album shuffle → Off.





Switching the display

Press .

Track title, Artist name and Album title are shown on the display.

To return to the previous display, press  or .

Adjusting sound quality and volume balance

- 1 Press  to enter iPod menu mode.
- 2 Turning  changes sound modes. (→P. 250)

■ About iPod



- “Made for iPod” and “Made for iPhone” mean that an electronic accessory has been designed to connect specifically to iPod, or iPhone, respectively, and has been certified by the developer to meet Apple performance standards.
- Apple is not responsible for the operation of this device or its compliance with safety and regulatory standards. Please note and that the use of this accessory with iPod or iPhone may affect wireless performance.
- iPod is trademark of Apple Inc., registered in the U.S. and other countries.

■ iPod functions

- When an iPod is connected and the audio source is changed to iPod mode, the iPod will resume play from the same point in which it was last used.
- Depending on the iPod that is connected to the system, certain functions may not be available. If a function is unavailable due to a malfunction (as opposed to a system specification), disconnecting the device and reconnecting it once again may resolve the problem.
- While connected to the system, the iPod cannot be operated with its own controls. It is necessary to use the controls of the vehicle's audio system instead.
- When the battery level of an iPod is very low, the iPod may not operate. If so, charge the iPod before use.
- Supported models (→P. 271)

■ iPod problems

To resolve most problems encountered when using your iPod, disconnect your iPod from the vehicle iPod connection and reset it.

For instructions on how to reset your iPod, refer to your iPod Owner's Manual.

■ Display

→P. 260

■ Error messages

If an error message is displayed, refer to the following table and take the appropriate measures. If the problem is not rectified, take the vehicle to any authorized Toyota dealer or repairer, or another duly qualified and equipped professional.

Message	Cause/Correction procedures
"ERROR"	This indicates a problem in the iPod or its connection.
"NO SONGS"	This indicates that there is no music data in the iPod.
"NO PLAYLIST"	This indicates that some available songs are not found in a selected playlist.
"UPDATE YOUR IPOD"	This indicates that the version of the iPod is not compatible. Upgrade your iPod software to the latest version.

■ Compatible models

Model	Generation	Software version
iPod	5th generation	Ver. 1.3.0 or higher
iPod nano	1st generation	Ver. 1.3.1 or higher
	2nd generation	Ver. 1.1.3 or higher
	3rd generation	Ver. 1.1.3 or higher
	4th generation	Ver. 1.0.4 or higher
	5th generation	Ver. 1.0.1 or higher
iPod touch	1st generation	Ver. 3.1.2 or higher
	2nd generation	Ver. 3.1.2 or higher
	Late 2009 (8 GB)	Ver. 3.1.2 or higher
	Late 2009 (32 GB/64 GB)	Ver. 3.1.2 or higher
iPod classic	1st generation	Ver. 1.1.2 or higher
	2nd generation (120 GB)	Ver. 2.0.1 or higher
	Late 2009 (160 GB)	Ver. 2.0.3 or higher
iPhone	1st generation (iPhone)	Ver. 3.1.2 or higher
	2nd generation (iPhone 3G)	Ver. 3.1.2 or higher
	3rd generation (iPhone 3GS)	Ver. 3.1.2 or higher
	4th generation (iPhone 4)	Ver. 4.0.0 or higher

Depending on differences between models or software version etc., some models listed above might be incompatible with this system.

iPod 4th generation and earlier models are not compatible with this system.

iPod mini, iPod shuffle and iPod photo are not compatible with this system.

Items related to standards and limitations are as follows:

- Maximum number of lists in device: 9999
- Maximum number of songs in device: 65535
- Maximum number of songs per list: 65535

**WARNING****■ Caution while driving**

Do not connect iPod or operate the controls.

**NOTICE****■ To prevent damage to iPod**

- Do not leave iPod in the vehicle. The temperature inside the vehicle may become high, resulting in damage to the iPod.
- Do not push down on or apply unnecessary pressure to the iPod while it is connected as this may damage the iPod or its terminal.
- Do not insert foreign objects into the port as this may damage the iPod or its terminal.

Listening to a USB memory device*

Connecting a USB memory device enables you to enjoy music from the vehicle speakers. Press  until "USB" is displayed.

Connecting a USB memory

→P. 249

Control panel

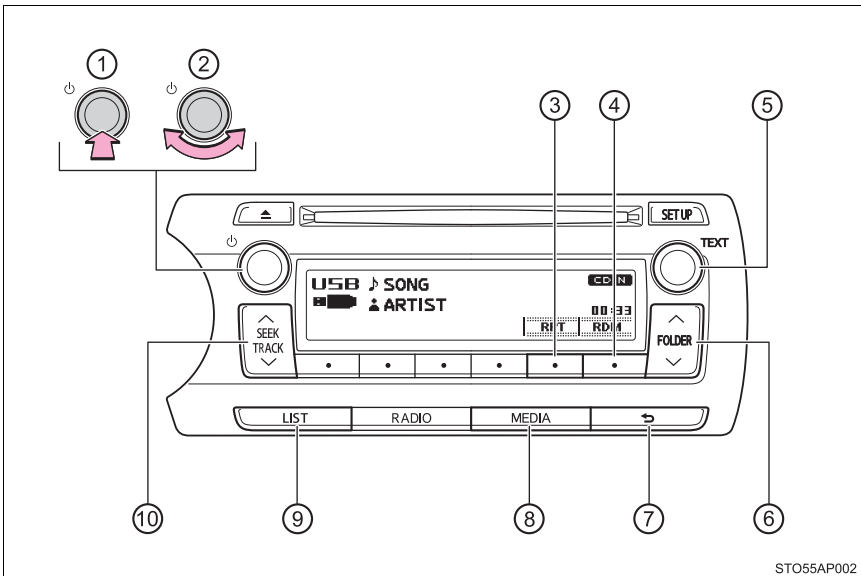

- | | |
|---|--|
| ① Power | ⑥ Selecting a folder |
| ② Volume | ⑦ Back button |
| ③ Repeat play | ⑧ Playback |
| ④ Random playback | ⑨ Displays folder list |
| ⑤ Selecting a file or displays text message | ⑩ Selecting a file, fast-forwarding or reversing |

Selecting a folder

■ Selecting a folders one at a time

Press “^” or “v” on  to select the desired folder.

■ Selecting a folder and file from folder list

1 Press  .

The folder list will be displayed.

2 Turn and press  to select a folder and a file.



To return to the previous display, press  .

To exit, press  .

■ Returning to the first folder

Press and hold “v” on  until you hear a beep.

Selecting files

Turn  or press “^” or “v” on  to select the desired file.

Fast-forwarding and reversing files

To fast-forward or reverse, press and hold “^” or “v” on  .

Repeat play

Pressing  (RPT) changes modes in the following order:

File repeat → Folder repeat* → Off.



*: Available except when RDM (random playback) is selected

Random playback

Pressing  (RDM) changes modes in the following order:

Folder random → Disc random → Off.

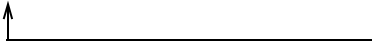

Switching the display

Press  .

Track title, Artist name and Album title (MP3 only) are displayed on the display.

To return to the previous display, press  or  .

■ USB memory functions

- Depending on the USB memory that is connected to the system, the device itself may not be operable and certain functions may not be available. If the device is inoperable or a function is unavailable due to a malfunction (as opposed to a system specification), disconnecting the device and reconnecting it once again may resolve the problem.
- If the USB memory still does not begin operation after being disconnected and reconnected, format the memory.

■ Display

→P. 260

■ Error messages

If an error message is displayed, refer to the following table and take the appropriate measures. If the problem is not rectified, take the vehicle to any authorized Toyota dealer or repairer, or another duly qualified and equipped professional.

Message	Cause/Correction procedures
“ERROR”	This indicates a problem in the USB memory or its connection.
“NO MUSIC”	This indicates that no MP3/WMA files are included in the USB memory device.

■ USB memory

● Compatible devices

USB memory that can be used for MP3 and WMA playback

● Compatible device formats

The following device formats can be used:

- USB communication formats: USB2.0 FS (12 Mbps)
- File formats: FAT12/16/32 (Windows)
- Correspondence class: Mass storage class

MP3 and WMA files written in any format other than those listed above may not play correctly, and their file names and folder names may not be displayed correctly.

Items related to standards and limitations are as follows:

- Maximum directory hierarchy: 8 levels
- Maximum number of folders in a device: 999 (including the root)
- Maximum number of files in a device: 9999
- Maximum number of files per folder: 255

● MP3 and WMA files

MP3 (MPEG Audio LAYER 3) is a standard audio compression format.

Files can be compressed to approximately 1/10 of their original size using MP3 compression.

WMA (Windows Media Audio) is a Microsoft audio compression format.

This format compresses audio data to a size smaller than that of the MP3 format.

There is a limit to the MP3 and WMA file standards that can be used and to the media/formats on which the files are recorded.

● MP3 file compatibility

• Compatible standards

MP3 (MPEG1 AUDIO LAYERII, III, MPEG2 AUDIO LAYERII, III, MPEG2.5)

• Compatible sampling frequencies

MPEG1 AUDIO LAYERII, III: 32, 44.1, 48 (kHz)

MPEG2 AUDIO LAYERII, III: 16, 22.05, 24 (kHz)

MPEG2.5: 8, 11.025, 12 (kHz)

• Compatible bit rates (compatible with VBR)

MPEG1 AUDIO LAYERII, III: 32-320 (kbps)

MPEG2 AUDIO LAYERII, III: 32-160 (kbps)

MPEG2.5: 32-160 (kbps)

• Compatible channel modes: stereo, joint stereo, dual channel and mon-aural

- WMA file compatibility
 - Compatible standards
WMA Ver. 9
 - Compatible sampling frequencies
HIGH PROFILE 32, 44.1, 48 (kHz)
 - Compatible bit rates
HIGH PROFILE 32-320 (kbps, VBR)

- File names

The only files that can be recognized as MP3/WMA and played are those with the extension .mp3 or .wma.

- ID3 and WMA tags

ID3 tags can be added to MP3 files, making it possible to record the track title, artist name, etc.

The system is compatible with ID3 Ver. 1.0, 1.1, and Ver. 2.2, 2.3, 2.4 ID3 tags. (The number of characters is based on ID3 Ver. 1.0 and 1.1.)

WMA tags can be added to WMA files, making it possible to record the track title and artist name in the same way as with ID3 tags.

- MP3 and WMA playback

- When a device containing MP3 or WMA files is connected, all files in the USB memory are checked. Once the file check is finished, the first MP3 or WMA file is played. To make the file check finish more quickly, we recommend that you do not include any files other than MP3 or WMA files or create any unnecessary folders.
- When the USB memory is connected and the audio source is changed to USB memory mode, the USB memory will start playing the first file in the first folder. If the same device is removed and reinserted (and the contents have not been changed), the USB memory will resume play from the same point in which it was last used.

- Extensions

If the file extensions .mp3 and .wma are used for files other than MP3 and WMA files, they will be skipped (not played).

- Playback
 - To play MP3 files with steady sound quality, we recommend a fixed bit rate of at least 128 kbps and a sampling frequency of 44.1 kHz.
 - There is a wide variety of freeware and other encoding software for MP3 and WMA files on the market, and depending on the status of the encoding and the file format, poor sound quality or noise at the start of playback may result. In some cases, playback may not be possible at all.
 - Microsoft, Windows, and Windows Media are registered trademarks of Microsoft Corporation in the U.S.A. and other countries.

 **WARNING****■ Caution while driving**

Do not connect USB memory or operate the controls.

 **NOTICE****■ If the glove box cannot be fully closed**

Depending on the size and shape of the USB memory that is connected to the system, the glove box may not close fully. In this case, do not try to forcibly close the glove box, as this may damage the USB memory or the terminal, etc. Remove the USB memory, and use a different USB memory with a size and shape that allows the glove box to close fully when connected to the system.

■ To prevent damage to USB memory

- Do not leave USB memory in the vehicle. The temperature inside the vehicle may become high, resulting in damage to the player.
- Do not push down on or apply unnecessary pressure to the USB memory while it is connected as this may damage the USB memory or its terminal.
- Do not insert foreign objects into the port as this may damage the USB memory or its terminal.

Interior features

6

6-1. Using the air conditioning system and defogger

Manual air conditioning system	280
Automatic air conditioning system	287
Power heater	295
Seat heaters	297

6-2. Using the interior lights

Interior lights list.....	299
• Interior light.....	299
• Personal lights.....	300

6-3. Using the storage features

List of storage features	301
• Glove box	302
• Cup holders	303
• Bottle holders	304
• Auxiliary box	305
Luggage compartment features.....	306

6-4. Using the other interior features

Other interior features.....	309
• Sun visors.....	309
• Vanity mirrors	309
• Portable ashtray	310
• Cigarette lighter	311
• Power outlet	312
• Armrest.....	313
• Panoramic roof shade ...	313
• Assist grips	314

Manual air conditioning system*

The illustration below is for left-hand drive vehicles. Some dial and button positions are reversed for right-hand drive vehicles.

Air conditioning controls

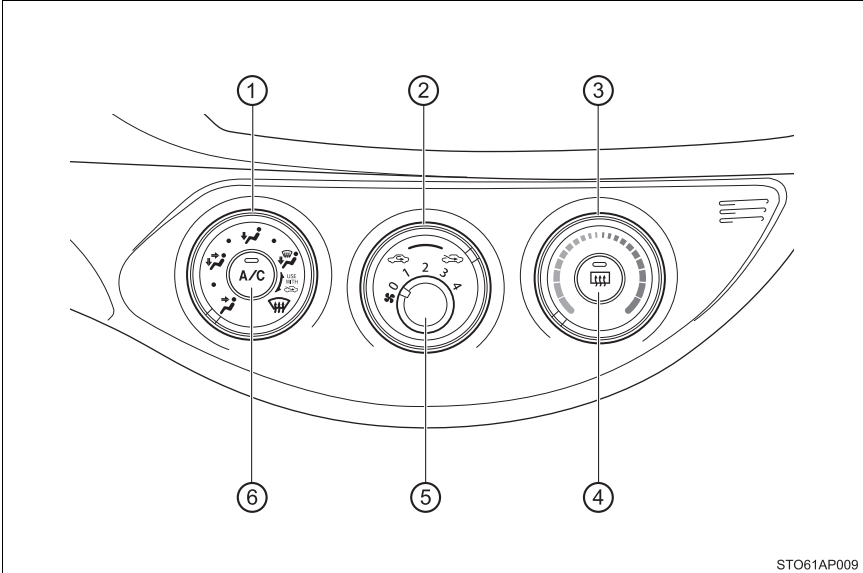

STO61AP009

- ① Air outlet selector dial
- ② Outside/recirculated air mode dial
- ③ Temperature control dial
- ④ Rear window defogger switch/ rear window defogger and outside rear view mirror defoggers switch (if equipped)
- ⑤ Fan speed control dial
- ⑥ Cooling and dehumidification function on/off button (if equipped)

*: If equipped

■ Adjusting the temperature setting

- ▶ Vehicles without the  button

Turn the temperature control dial clockwise to increase the temperature.

- ▶ Vehicles with the  button

To adjust the temperature setting, turn the temperature control dial clockwise (warm) or counterclockwise (cool).

If  is not pressed, the system will blow ambient temperature air or heated air.

■ Fan speed setting

To adjust the fan speed, turn the fan speed control dial clockwise (increase) or counterclockwise (decrease).

Turning the dial to “0” turns off the fan.

■ Change the airflow mode

To select the air outlets, set the air outlet selector dial to the desired position.

The positions between the air outlet selections can also be selected for more delicate adjustment.

- ① Air flows to the upper body
- ② Air flows to the upper body and feet
- ③ Air flows to the feet
- ④ Air flows to the feet and the windshield defogger operates
- ⑤ The windshield defogger operates

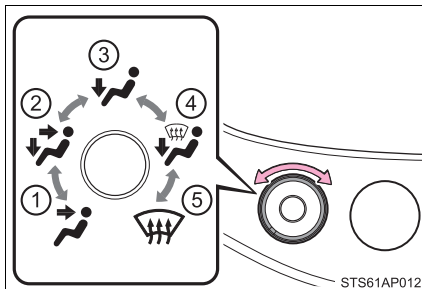

■ Other functions

- Switching between outside air and recirculated air modes (→P. 282)
- Defogging the windshield (→P. 282)
- Defogging the rear window and outside rear view mirrors (→P. 283)

Other functions

■ Switching between outside air and recirculated air modes

Turn the outside/recirculated air mode dial.

Select  to change to recirculated air mode.

Select  to change to outside air mode.

■ Defogging the windshield

Defoggers are used to defog the windshield and front side windows.

Set the air outlet selector dial to  position.

Set the outside/recirculated air mode dial to outside mode if recirculated air mode is used.

Perform the following operations accordingly:

- To adjust the fan speed, turn the fan speed control dial.
- To adjust the temperature setting, turn the temperature control dial.
- Vehicles with the  button: If the dehumidification function is not operating, press to operate the dehumidification function.

To defog the windshield and the side windows early, turn the air flow and temperature up.

■ Defogging the rear window and outside rear view mirrors

- ▶ Vehicles with a rear window defogger

Defoggers are used to defog the rear window.

Press .

The defoggers will automatically turn off after a period of time.

- ▶ Vehicles with rear window and outside rear view mirror defoggers

Defoggers are used to defog the rear window, and to remove rain-drops, dew and frost from the outside rear view mirrors.

Press .

The defoggers will automatically turn off after a period of time.

Air outlets

■ Location of air outlets

The air outlets and air volume changes according to the selected airflow mode.

← : Some models

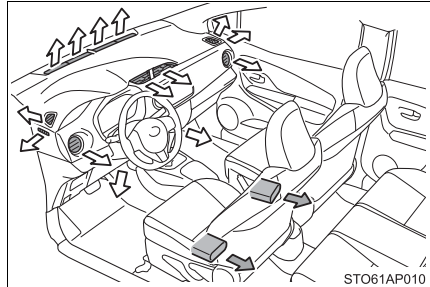

■ Adjusting the position, opening and closing the air outlets

- ▶ Front center outlets

- ① Direct air flow to the left or right, up or down.
- ② Turn the knob to open or close the vent.

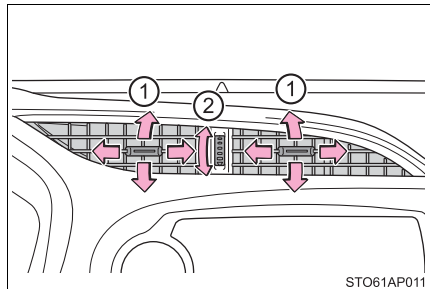

► Front side outlets



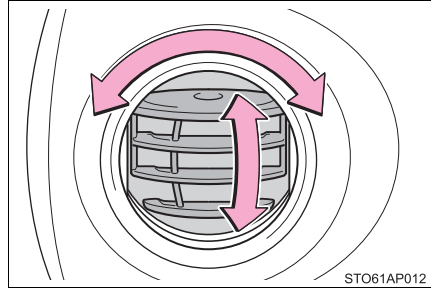

Direct air flow to the left or right, up or down.

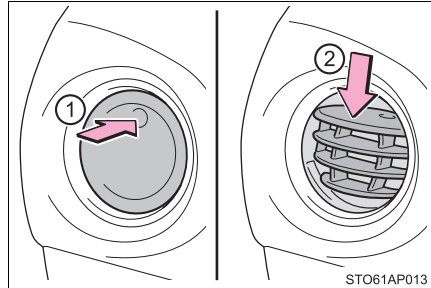

- ① Open the vent.
- ② Close the vent.



■ Fogging up of the windows

- Vehicles with the  button: The windows will easily fog up when the humidity in the vehicle is high. Turning  on will dehumidify the air from the outlets and defog the windshield effectively.
- Vehicles with the  button: If you turn  off, the windows may fog up more easily.
- The windows may fog up if the recirculated air mode is used.

■ Outside/recirculated air mode

When driving on dusty roads such as tunnels or in heavy traffic, set the outside/recirculated air mode dial to the recirculated air mode. This is effective in preventing outside air from entering the vehicle interior. During cooling operation, setting the recirculated air mode will also cool the vehicle interior effectively.

- **When the indicator light on  goes off by itself (vehicles with the  button)**

Press  to turn off the dehumidification function and turn it on again. There may be a problem in the air conditioning system if the indicator light goes off again. Turn the air conditioning system off and have it inspected by any authorized Toyota dealer or repairer, or another duly qualified and equipped professional.

- **When the outside temperature falls to nearly 0°C (32°F) (vehicles with the  button)**

The dehumidification function may not operate even when  is pressed.

- **Ventilation and air conditioning odors**

- To let fresh air in, set the air conditioning system to the outside air mode.
- During use, various odors from inside and outside the vehicle may enter into and accumulate in the air conditioning system. This may then cause odor to be emitted from the vents.
- To reduce potential odors from occurring:
It is recommended that the air conditioning system be set to outside air mode prior to turning the vehicle off.

- **An odor comes from the air conditioning system due to the Stop & Start system operation (vehicles with a Stop & Start system)**

When the engine is stopped due to the Stop & Start system, an odor caused by moisture may be detected. This does not indicate a malfunction.

- **Air conditioning filter**

→P. 365

**WARNING****■ To prevent the windshield from fogging up**

Do not set the air outlet selector dial to  during cool air operation in extremely humid weather. The difference between the temperature of the outside air and that of the windshield can cause the outer surface of the windshield to fog up, blocking your vision.

■ When the outside rear view mirror defoggers (if equipped) are on

Do not touch the outside surface of the rear view mirrors, as they can become very hot and burn you.

**NOTICE****■ To prevent battery discharge**

Do not leave the air conditioning system on longer than necessary when the engine is stopped.

Automatic air conditioning system*

Air outlets and fan speed are automatically adjusted according to the temperature setting.

Air conditioning controls

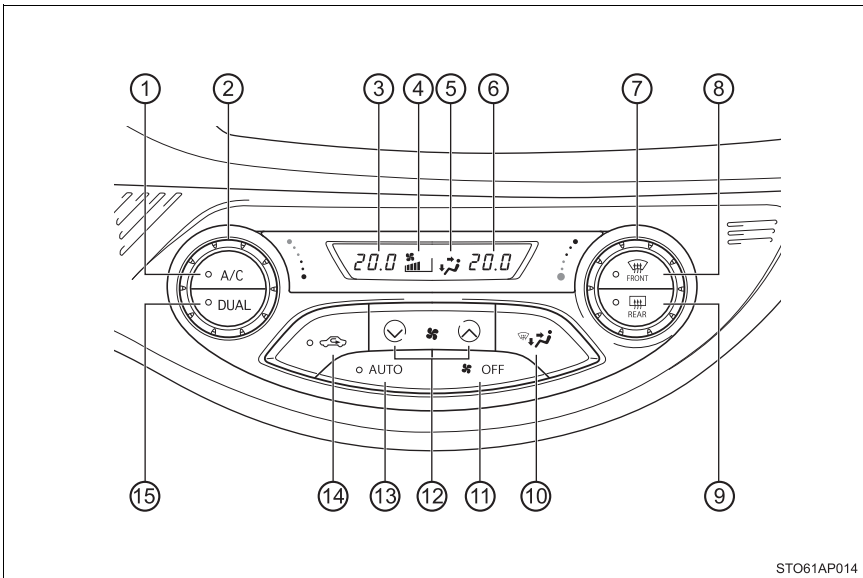

*: If equipped

- ① Cooling and dehumidification function on/off button
- ② Left-hand side temperature control dial
- ③ Left-hand side temperature display
- ④ Fan speed display
- ⑤ Air outlet display
- ⑥ Right-hand side temperature display
- ⑦ Right-hand side temperature control dial
- ⑧ Windshield defogger button
- ⑨ Rear window defogger switch/rear window defogger and outside rear view mirror defoggers switch (if equipped)
- ⑩ Air outlet selector button
- ⑪ “OFF” button
- ⑫ Fan speed control button
- ⑬ Automatic mode button
- ⑭ Outside/recirculated air mode button
- ⑮ Dual mode button

■ Adjusting the temperature setting

To adjust the temperature setting, turn the temperature control dial clockwise or counterclockwise.

If  is not pressed, the system will blow ambient temperature air or heated air.

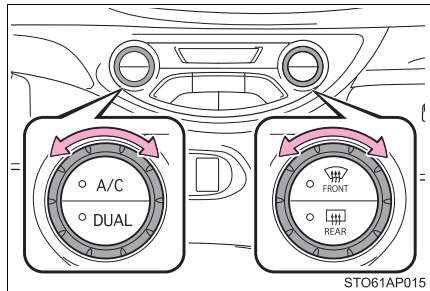

■ Adjusting the temperature for driver and passenger seats separately (“DUAL” mode)

To turn on the “DUAL” mode, perform any of the following procedure:

- Press .
- Adjust the passenger’s side temperature setting.
The indicator comes on when the “DUAL” mode is on.
To turn off the “DUAL” mode, press the switch again.

■ Fan speed setting

Press “^” on  to increase the fan speed.

Press “v” on  to decrease the fan speed.

Press  to turn the fan off.

■ Change the airflow mode

To change the air outlets, press



The air outlets used are switched each time the button is pressed.

- ① Air flows to the upper body
- ② Air flows to the upper body and feet
- ③ Air flows to the feet
- ④ Air flows to the feet and the windshield defogger operates

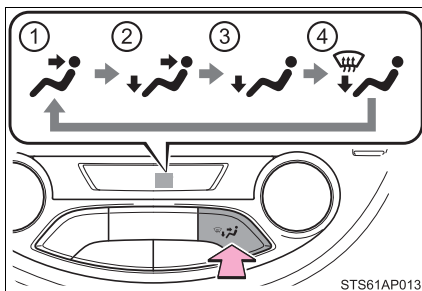

■ Other functions

- Switching between outside air and recirculated air modes (→P. 290)
- Defogging the windshield (→P. 291)
- Defogging the rear window and outside rear view mirrors (→P. 291)

Using automatic mode

- 1 Press .

Air outlets and fan speed are automatically adjusted according to the temperature setting.

- 2 Adjust the temperature setting.

- 3 To stop the operation, press .

Air outlets

■ Location of air outlets

The air outlets and air volume changes according to the selected airflow mode.

 : Some models

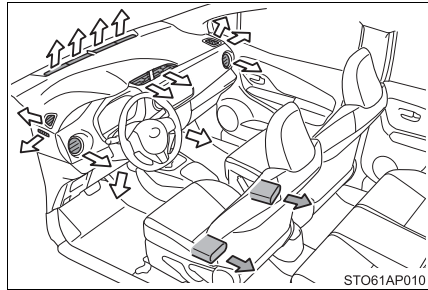

Other functions

■ Switching between outside air and recirculated air modes

Press .

The mode switches each time the button is pressed.

The indicator comes on when the recirculated air mode is on.

■ Defogging the windshield

Defoggers are used to defog the windshield and front side windows.

Press .

The dehumidification function operates and fan speed increases.

Set the outside/recirculated air mode button to outside mode if recirculated air mode is used. (It may switch automatically.)

To defog the windshield and the side windows early, turn the air flow and temperature up.

To return to the previous mode, press  again when the windshield is defogged.

■ Defogging the rear window and outside rear view mirrors

- ▶ Vehicles with a rear window defogger

Defogger is used to defog the rear window.

Press .

The defogger will automatically turn off after a period of time.

- ▶ Vehicles with rear window and outside rear view mirror defoggers

Defoggers are used to defog the rear window, and to remove raindrops, dew and frost from the outside rear view mirrors.

Press .

The defoggers will automatically turn off after a period of time.

■ Adjusting the position, opening and closing the air outlets

▶ Front center outlets

- ① Direct air flow to the left or right, up or down.
- ② Turn the knob to open or close the vent.

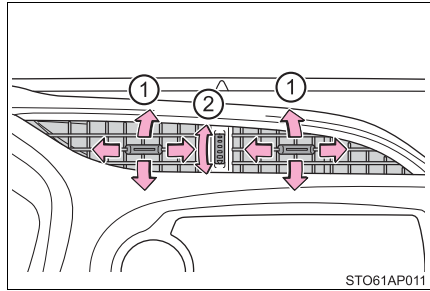

▶ Front side outlets

Direct air flow to the left or right, up or down.

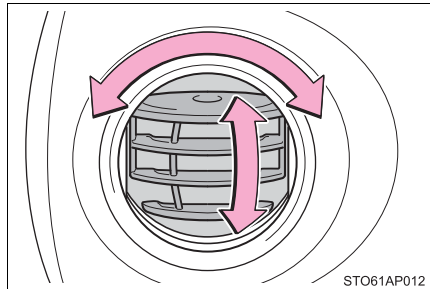

- ① Open the vent.
- ② Close the vent.

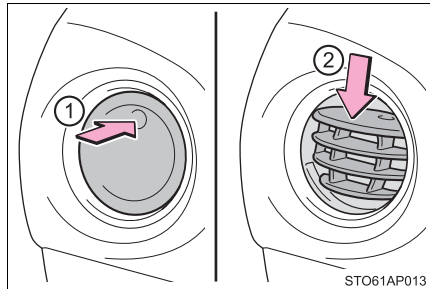

■ Using automatic mode

Fan speed is adjusted automatically according to the temperature setting and the ambient conditions.

Therefore, the fan may stop for a while until warm or cool air is ready to flow immediately after  is pressed.

■ Fogging up of the windows

- The windows will easily fog up when the humidity in the vehicle is high.

Turning  on will dehumidify the air from the outlets and defog the windshield effectively.

- If you turn  off, the windows may fog up more easily.
- The windows may fog up if the recirculated air mode is used.

■ Outside/recirculated air mode

- When driving on dusty roads such as tunnels or in heavy traffic, set the outside/recirculated air mode button to the recirculated air mode. This is effective in preventing outside air from entering the vehicle interior. During cooling operation, setting the recirculated air mode will also cool the vehicle interior effectively.
- Outside/recirculated air mode may automatically switch depending on the temperature setting or the inside temperature.

■ When the outside temperature falls to nearly 0°C (32°F)

The dehumidification function may not operate even when  is pressed.

■ When the indicator light on goes off by itself

Press  to turn off the dehumidification function and turn it on again.

There may be a problem in the air conditioning system if the indicator light goes off again. Turn the air conditioning system off and have it inspected by any authorized Toyota dealer or repairer, or another duly qualified and equipped professional.

■ Ventilation and air conditioning odors

- To let fresh air in, set the air conditioning system to the outside air mode.
- During use, various odors from inside and outside the vehicle may enter into and accumulate in the air conditioning system. This may then cause odor to be emitted from the vents.
- To reduce potential odors from occurring:
 - It is recommended that the air conditioning system be set to outside air mode prior to turning the vehicle off.
 - The start timing of the blower may be delayed for a short period of time immediately after the air conditioning system is started in AUTO mode.

■ Air conditioning system operations when the engine is stopped due to the Stop & Start system (vehicles with a Stop & Start system)

When the engine is stopped due to Stop & Start system operations, the automatic air conditioning cooling, heating and dehumidification functions turn off and the fan speed is decreased according to the outside temperature etc. or air blowing stops. To stop the air conditioning system from turning off, press the Stop & Start cancel switch and refrain from using the Stop & Start system.

■ An odor comes from the air conditioning system due to the Stop & Start system operation (vehicles with a Stop & Start system)

When the engine is stopped due to the Stop & Start system, an odor caused by moisture may be detected. This does not indicate a malfunction.

■ Air conditioning filter

→P. 365



WARNING

■ To prevent the windshield from fogging up

Do not use  during cool air operation in extremely humid weather. The difference between the temperature of the outside air and that of the windshield can cause the outer surface of the windshield to fog up, blocking your vision.

■ When the outside rear view mirror defoggers (if equipped) are on

Do not touch the outside surface of the rear view mirrors, as they can become very hot and burn you.



NOTICE

■ To prevent battery discharge

Do not leave the air conditioning system on longer than necessary when the engine is stopped.

Power heater*

This feature is used to keep the cabin warm in cold conditions.

Power heater

Turns the power heater on/off

The power heater turns on about 25 seconds after the switch is pressed, and takes about another 85 seconds to warm up.

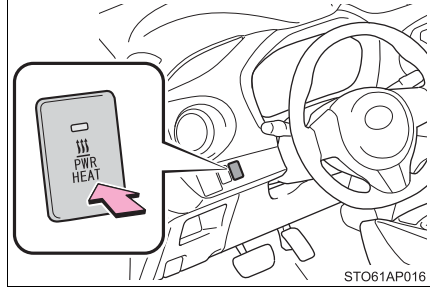

■ Power heater can be operated when

The engine is running.

■ Normal characteristics of power heater operation

The following cases do not indicate a malfunction:

- When the power heater is turned on or off, some white smoke and a slight odor may be emitted from the power heater exhaust that is located under the floor.
- When the power heater is used under extremely cold conditions, vapor may be visible from its exhaust.
- When the power heater is turned off, you may hear a sound in the engine compartment for about 2 minutes until the power heater turns off completely.

■ After the heater is turned off

We recommend not restarting the heater for 10 minutes after you turn it off. Otherwise, a noise may be heard as the heater ignites.

■ When refueling your vehicle

The engine must be turned off. Turning the engine off turns the power heater off.

⚠ WARNING**■ To prevent burns or damage to your vehicle**

- Do not touch the heater or its exhaust pipe as they are hot. You may burn yourself.
- Keep flammable items such as fuel away from the heater and its exhaust pipe, as this may cause a fire.

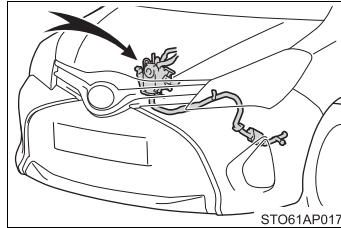
**⚠ NOTICE****■ To prevent damage to your vehicle**

- Do not turn the heater on and off repeatedly in 5 minute intervals as this can shorten the life of the heater components. If the engine must be turned on and off repeatedly within short intervals (such as when the vehicle is being used for delivery purposes), turn the heater off.
- Do not modify or open the heater without consulting any authorized Toyota dealer or repairer, or another duly qualified and equipped professional, as this may cause a heater malfunction or a fire.
- Be careful not to splash or spill liquid directly on the heater or on the heater fuel pump, as this may cause the heater to malfunction.
- Keep the intake and exhaust pipes of the heater free from water, snow, ice, mud, etc. If the pipes become clogged, this can cause the heater to malfunction.
- If you notice anything unusual, such as a fluid leak, smoke and poor operation, turn off the heater and have your vehicle checked by any authorized Toyota dealer or repairer, or another duly qualified and equipped professional.

Seat heaters*

Operating instructions

- ① Turns on the front left seat heater
- ② Turns on the front right seat heater

The indicator light comes on.

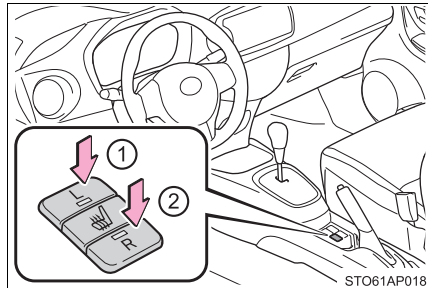

■ The seat heaters can be used when

Vehicles without a smart entry & start system:
The engine switch is in the “ON” position.

Vehicles with a smart entry & start system:
The engine switch is in IGNITION ON mode.

■ When not in use

Turn the seat heater off.

**WARNING****■ Burns**

- Use caution when seating the following persons in a seat with the seat heater on to avoid the possibility of burns:
 - Babies, small children, the elderly, the sick and the physically challenged
 - Persons with sensitive skin
 - Persons who are fatigued
 - Persons who have taken alcohol or drugs that induce sleep (sleeping drugs, cold remedies, etc.)
- Do not cover the seat with anything when using the seat heater. Using the seat heater with a blanket or cushion increases the temperature of the seat and may lead to overheating.
- Do not use the seat heater more than necessary. Doing so may cause minor burns or overheating.

**NOTICE****■ To prevent seat heater damage**

Do not put heavy objects that have an uneven surface on the seat and do not stick sharp objects (needles, nails, etc.) into the seat.

■ To prevent battery discharge

Turn the seat heaters off when the engine is not running.

Interior lights list

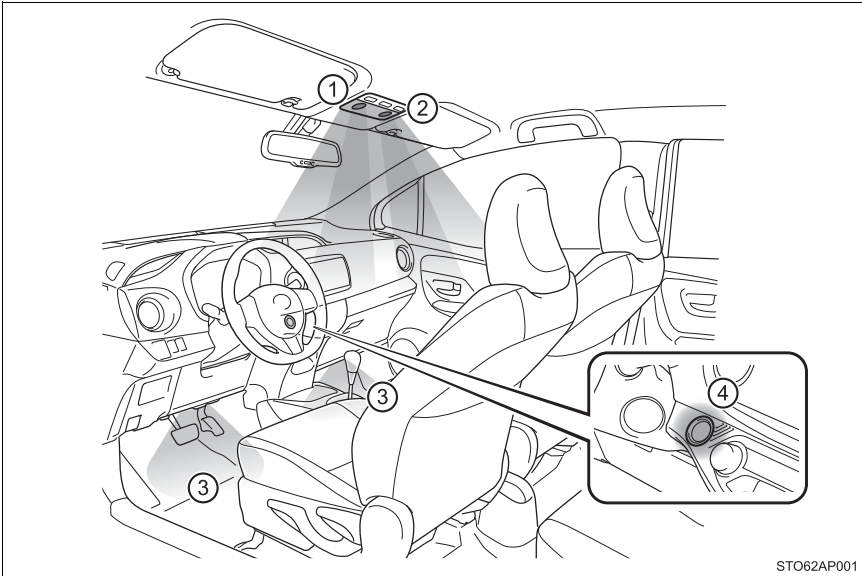

- ① Interior light (→P. 299)
- ② Personal lights (→P. 300)
- ③ Footwell lights (if equipped)
- ④ Engine switch light (vehicles with a smart entry & start system)

Interior light

- ① Off
- ② Door position
- ③ On

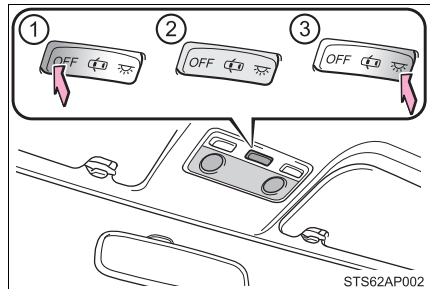

Personal lights

- ① On
- ② Off

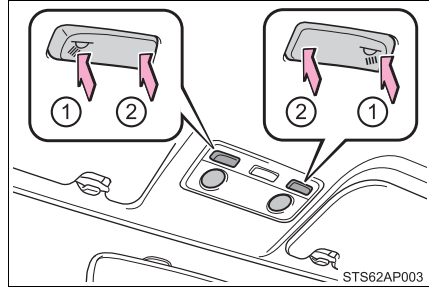

■ Illuminated entry system

- ▶ Vehicles without a smart entry & start system

The lights automatically turn on/off according to the engine switch position, whether the doors are locked/unlocked, and whether the doors are opened/closed.

- ▶ Vehicles with a smart entry & start system

The lights automatically turn on/off according to engine switch mode, the presence of the electronic key, whether the doors are locked/unlocked, and whether the doors are opened/closed.

■ To prevent battery from being discharged

- The following lights will go off automatically after 20 minutes:
 - Interior/personal lights
 - Luggage compartment light
 - Footwell lights
- If the engine switch light remain on when the door is not fully closed, the light will go off automatically after 20 minutes.

■ Customization

Settings (e.g. the time elapsed before lights turn off) can be changed.
(Customizable features →P. 489)

List of storage features

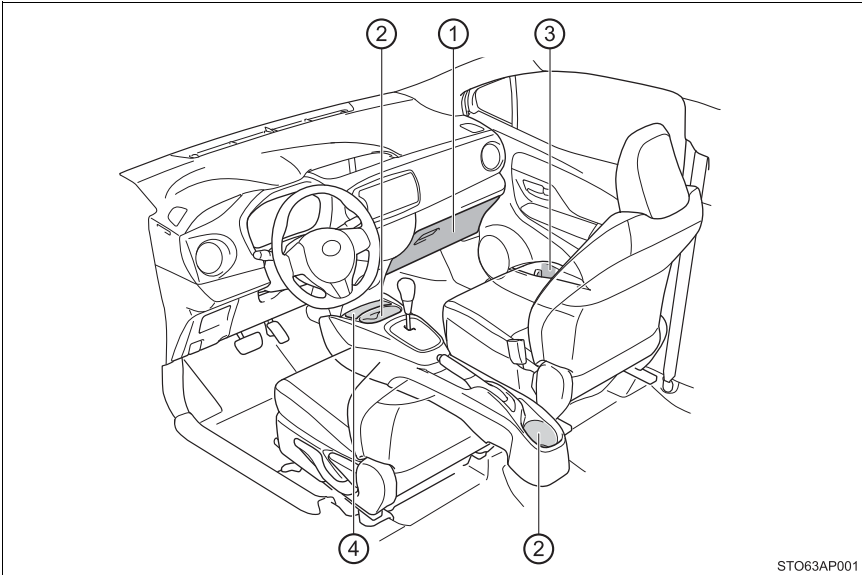

- | | | | |
|---------------|-----------|------------------|-----------|
| ① Glove box | (→P. 302) | ③ Bottle holders | (→P. 304) |
| ② Cup holders | (→P. 303) | ④ Auxiliary box | (→P. 305) |

WARNING

■ Items that should not be left in the storage spaces

Do not leave glasses, lighters or spray cans in the storage spaces, as this may result in the following when cabin temperature becomes high:

- Glasses may be deformed by heat or cracked if they come into contact with other stored items.
- Lighters or spray cans may explode. If they come into contact with other stored items, the lighter may catch fire or the spray can may release gas, causing a fire hazard.

Glove box

Pull up the lever to open the glove box.

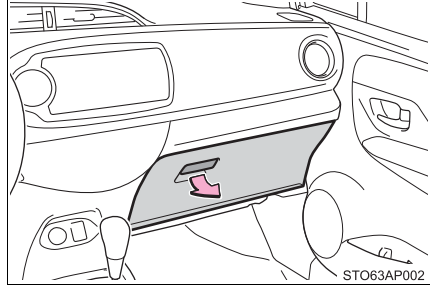

■ Using the glove box vent (if equipped)

Air from the air conditioning system can be distributed into the glove box by opening and closing the vent.

- ① Open
- ② Close

The air is conditioned the same as the air for the passenger side vent.

Perishable items should not be put in the box.

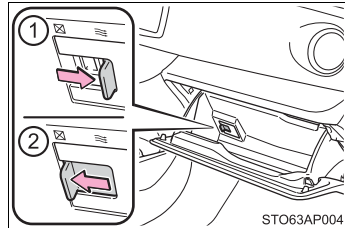

⚠ WARNING

■ Caution while driving

Keep the glove box closed. In the event of sudden braking or sudden swerving, an accident may occur due to an occupant being struck by the open glove box or the items stored inside.

Cup holders

■ Front

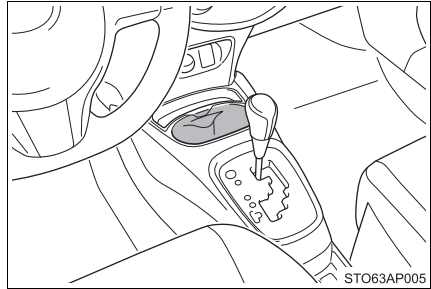

■ Rear

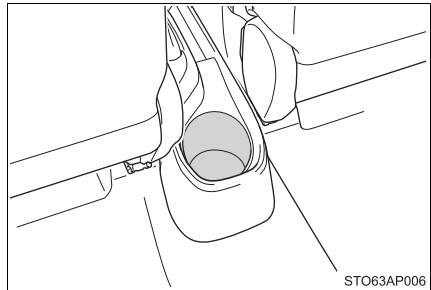

WARNING

■ Items unsuitable for the cup holders

- Do not place anything other than cups or aluminum cans in the cup holders. Other items may be thrown out of the holders in the event of an accident or sudden braking, causing injury.
- To prevent burns, cover hot drinks when placed in the cup holders.

Bottle holders

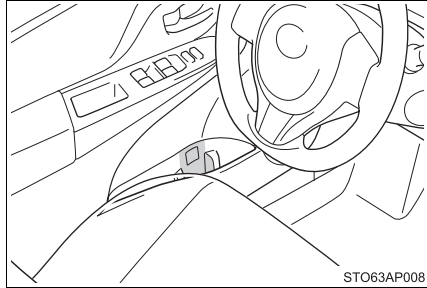

■ When using the bottle holders

- When storing a bottle, close the cap.
- The bottle may not be stored depending on its size or shape.

⚠ WARNING

■ Items unsuitable for the bottle holders

Do not place anything other than a bottle in the bottle holders. Other items may be thrown out of the holders in the event of an accident or sudden braking and cause injury.

⚠ NOTICE

■ Items that should not be stowed in the bottle holders

Put the cap on before stowing a bottle. Do not place open bottles in the bottle holders, or glasses and paper cups containing liquid. The contents may spill and glasses may break.

Auxiliary box

▶ Type A

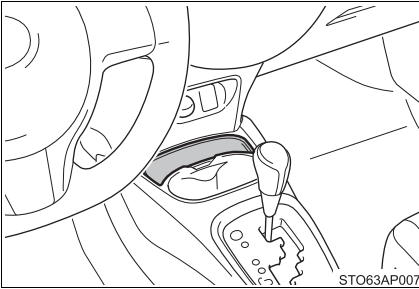

▶ Type B

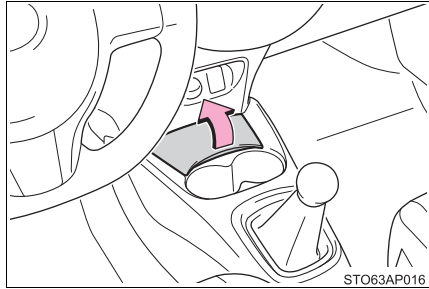

Open the cover.

▶ Type C

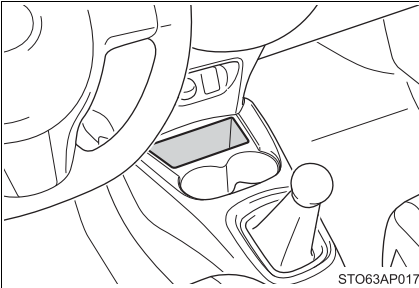

⚠ WARNING

■ Caution while driving (Type B)

Keep the auxiliary boxes closed. In the event of sudden braking, an accident may occur due to an occupant being struck by an open auxiliary box or the items stored inside.

Luggage compartment features

Luggage cover (if equipped)

The luggage cover can be removed by the following procedure:

- 1 Unhook the cords and return the luggage cover to horizontal position.

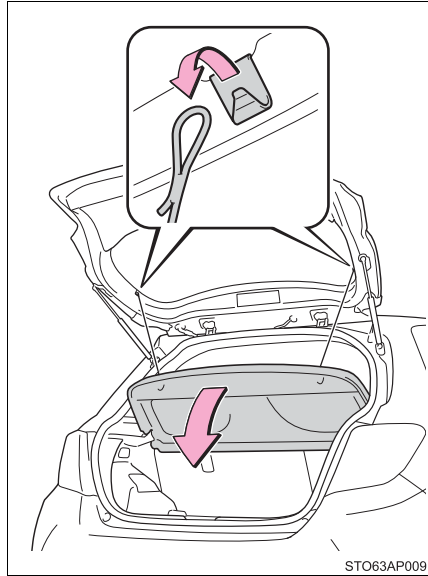

- 2 Lift the luggage cover and pull it toward you to remove it.

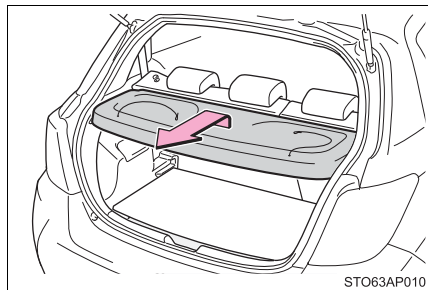

Deck board (if equipped)

■ Deck board height adjustment

- ① Upper position
- ② Lower position

The lower position can be used when the deck board is placed on the luggage floor cover.

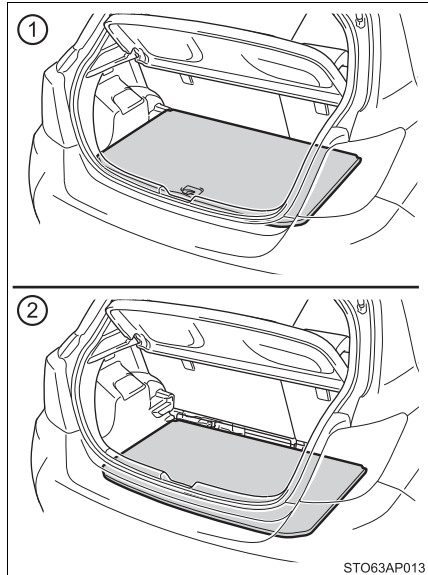

■ Removing the deck board

Lift the deck board and pull it toward you to remove it.

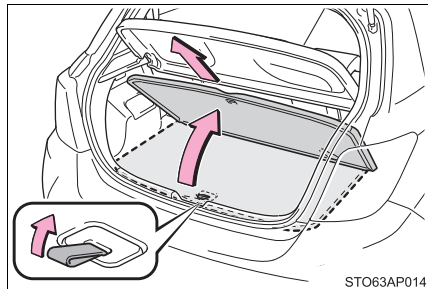

⚠ WARNING

■ When operating the deck board

Do not place anything on the deck board when operating the board. Otherwise, your fingers may be caught or an accident may result causing injuries.

Auxiliary box (if equipped)

Lift the deck board and the luggage floor cover.

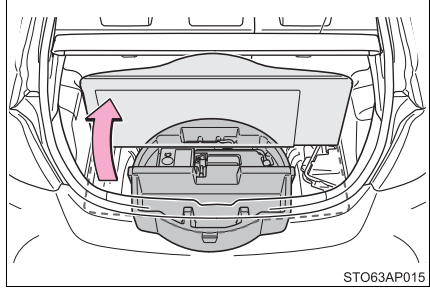

Other interior feature

Sun visors

- ① To set the visor in the forward position, flip it down.
- ② To set the visor in the side position, flip down, unhook, and swing it to the side.

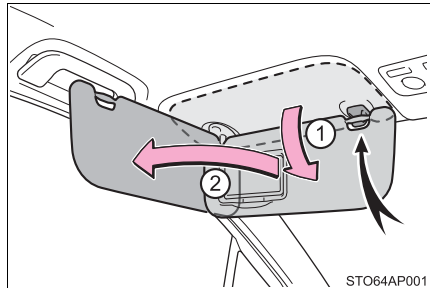

Vanity mirrors

Open the cover.

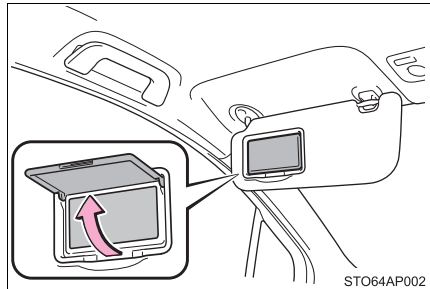

■ Vanity lights (if equipped)

- ① Turns the lights on
- ② Turns the lights off

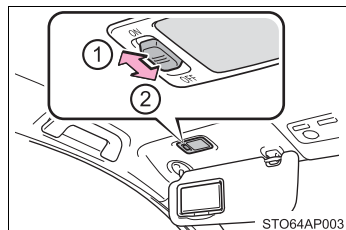

■ Vanity lights can be used when

- ▶ Vehicles without a smart entry & start system

The engine switch is in the “ACC” or “ON” position.

- ▶ Vehicles with a smart entry & start system

The engine switch is ACCESSORY or IGNITION ON mode.



NOTICE

■ To prevent battery discharge (vehicles with vanity lights)

Do not leave the vanity lights on for extended periods while the engine is not running.

Portable ashtray (if equipped)

The ashtray can be installed in a cup holder. (→P. 303)

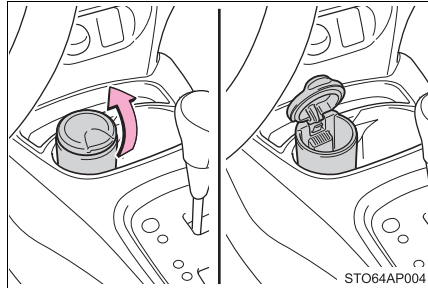

WARNING

■ When not in use

Keep the ashtray closed. In the event of sudden braking or sudden swerving, an accident may occur due to an occupant being struck by the open ashtray or ash flying out.

■ To prevent fire

- Fully extinguish matches and cigarettes before putting them in the ashtray, then make sure the ashtray is fully closed.
- Do not place paper or any other type of flammable object in the ashtray.

Cigarette lighter (if equipped)

Push the cigarette lighter.

The cigarette lighter will pop up when it is ready for use.

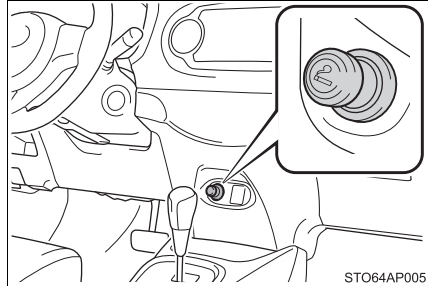

■ The cigarette lighter can be used when

▶ Vehicles without a smart entry & start system

The engine switch is in the “ACC” or “ON” position.

▶ Vehicles with a smart entry & start system

The engine switch is in ACCESSORY or IGNITION ON mode.

⚠ WARNING

■ To avoid burns or fires

- Do not touch the metal parts of the cigarette lighter.
- Do not hold the cigarette lighter down. It could overheat and cause a fire.
- Do not insert anything other than the cigarette lighter provided into the cigarette lighter outlet. Doing so may deform the outlet and make the cigarette lighter pop out of the outlet or become difficult to take out.

Power outlet (if equipped)

Please use as a power supply for electronic goods that use less than 12 VDC/10 A (power consumption of 120 W).

Open the lid.

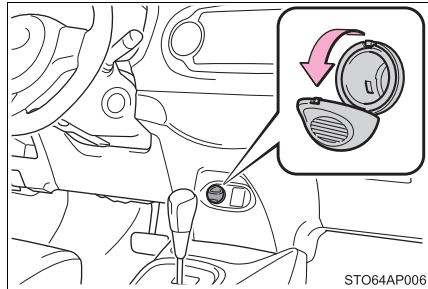
**■ The power outlets can be used when**

- ▶ Vehicles without a smart entry & start system

The engine switch is in the “ACC” or “ON” position.

- ▶ Vehicles with a smart entry & start system

The engine switch is in ACCESSORY or IGNITION ON mode.

⚠ NOTICE**■ To avoid damaging the power outlet**

Close the power outlet lid when the power outlet is not in use.

Foreign objects or liquids that enter the power outlet may cause a short circuit.

■ To prevent battery discharge

Do not use the power outlet longer than necessary when the engine is not running.

Armrest (if equipped)

Fold down the armrest for use.

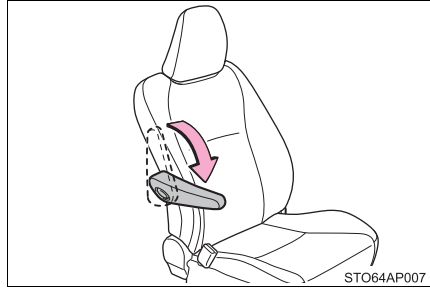

NOTICE

■ To prevent damage to the armrest

Do not apply too much load on the armrest.

Panoramic roof shade (if equipped)

The panoramic roof shade can be opened and closed manually.

■ Opening the panoramic roof shade

Pushing the tabs will release the lock, and the shade can be opened.

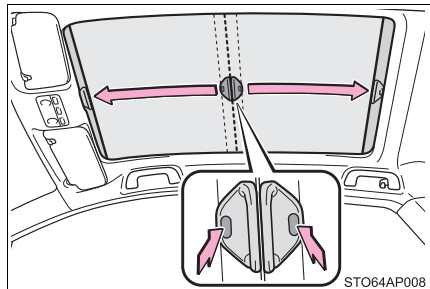

■ Closing the panoramic roof shade

Pull the tabs to the lock position to close the shade.

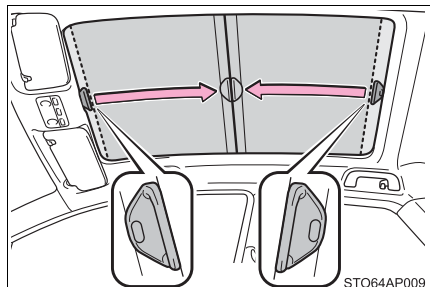

Assist grips

An assist grip installed on the ceiling can be used to support your body while sitting on the seat.

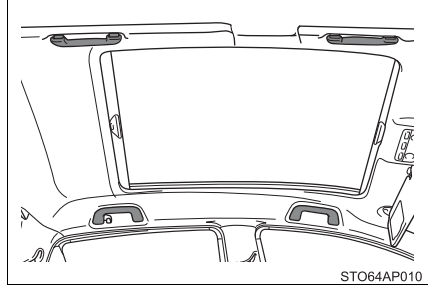

WARNING

■ Assist grip

Do not use the assist grip when getting in or out of the vehicle or rising from your seat.
Doing so could damage the assist grip, or could cause you to injure yourself by falling over.

NOTICE

■ To prevent damage to the assist grip

Do not hang any heavy object or put a heavy load on the assist grip.

Maintenance and care

7

7-1. Maintenance and care

- Cleaning and protecting the vehicle exterior316
- Cleaning and protecting the vehicle interior319

7-2. Maintenance

- Maintenance requirements.....322

7-3. Do-it-yourself maintenance

- Do-it-yourself service precautions325
- Hood328
- Positioning a floor jack.....330
- Engine compartment.....332
- Tires.....347
- Tire inflation pressure360
- Wheels.....362
- Air conditioning filter365
- Wireless remote control/ electronic key battery.....367
- Checking and replacing fuses370
- Light bulbs376

Cleaning and protecting the vehicle exterior

Perform the following to protect the vehicle and maintain it in prime condition:

- Working from top to bottom, liberally apply water to the vehicle body, wheel wells and underside of the vehicle to remove any dirt and dust.
- Wash the vehicle body using a sponge or soft cloth, such as a chamois.
- For hard-to-remove marks, use car wash soap and rinse thoroughly with water.
- Wipe away any water.
- Wax the vehicle when the waterproof coating deteriorates.

If water does not bead on a clean surface, apply wax when the vehicle body is cool.

■ Automatic car washes

- Fold the mirrors and remove the antenna before washing the vehicle. Start washing from the front of the vehicle. Make sure to re-install the antenna and extend the mirrors before driving.
- Brushes used in automatic car washes may scratch the vehicle surface and harm your vehicle's paint.
- Rear spoiler (if equipped) may not be washable in some automatic car washes. There may also be an increased risk of damage to vehicle.

■ High pressure car washes

- Do not allow the nozzles of the car wash to come within close proximity of the windows and door borders, and high mounted stoplight.
- Before using the car wash, check that the fuel filler door on your vehicle is closed properly.

■ When using a car wash (vehicles with a smart entry & start system)

If the door handle becomes wet while the electronic key is within the effective range, the door may lock and unlock repeatedly. Place the key in a position 2 m (6 ft.) or more separate from the vehicle while the vehicle is being washed. (Take care to ensure that the key is not stolen.)

■ Aluminum wheels (if equipped)

- Remove any dirt immediately by using a neutral detergent. Do not use hard brushes or abrasive cleaners. Do not use strong or harsh chemical cleaners.
Use the same mild detergent and wax as used on the paint.
- Do not use detergent on the wheels when they are hot, for example after driving for long distance in the hot weather.
- Wash detergent from the wheels immediately after use.
- To preserve the wheels luster, do not allow hot water, such as from steam cleaning, to contact them directly.

■ Bumpers

Do not scrub with abrasive cleaners.

⚠ WARNING

■ When cleaning the windshield (vehicles with a rain-sensing windshield wiper)

Set the wiper switch to off.

If the wiper switch is in "AUTO", the wiper may operate unexpectedly in the following situations, and may result in hands being caught or other serious injuries and cause damage to the wiper blades.

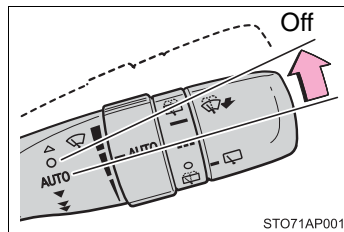

- When the upper part of the windshield where the raindrop sensor is located is touched by hand
- When a wet rag or similar is held close to the raindrop sensor
- If something bumps against the windshield
- If you directly touch the raindrop sensor body or if something bumps into the raindrop sensor

■ When washing the vehicle

Do not apply water to the inside of the engine compartment. Doing so may cause the electrical components etc. to catch fire.

■ Precautions regarding the exhaust pipes

Exhaust gases cause the exhaust pipes to become quite hot.

When washing the vehicle, be careful not to touch the pipes until they have cooled sufficiently, as touching hot exhaust pipes can cause burns.

 NOTICE**■ To prevent paint deterioration and corrosion on the body and components (aluminum wheels etc.)**

- Wash the vehicle immediately in the following cases:
 - After driving near the sea coast
 - After driving on salted roads
 - If coal tar or tree sap is present on the paint surface
 - If dead insects, insect droppings or bird droppings are present on the paint surface
 - After driving in an area contaminated with soot, oily smoke, mine dust, iron powder or chemical substances
 - If the vehicle becomes heavily soiled with dust or mud
 - If liquids such as benzene and gasoline are spilled on the paint surface
- If the paint is chipped or scratched, have it repaired immediately.
- To prevent the wheels from corroding, remove any dirt and store in a place with low humidity when storing the wheels.

■ Cleaning the exterior lights

- Wash carefully. Do not use organic substances or scrub with a hard brush. This may damage the surfaces of the lights.
- Do not apply wax to the surfaces of the lights. Wax may cause damage to the lenses.

■ Antenna installation and removal precautions

- Before driving, ensure that the antenna is installed.
- When the antenna is removed, such as before entering an automatic car wash, make sure to store it in a suitable place so as not to lose it. Also, before driving, make sure to reinstall the antenna in its original position.

■ When using an automatic car wash (vehicles with a rain-sensing windshield wiper)

Set the wiper switch to the off position.

If the wiper switch is in "AUTO", the wiper may operate and the wiper blade may be damaged.

■ To prevent damage to the antenna

Remove the antenna in the following situations:

- When the antenna will touch the ceiling of a garage or other such places
- When a car cover is to be used to cover the vehicle

Cleaning and protecting the vehicle interior

The following procedures will help protect your vehicle's interior and keep it in top condition:

Protecting the vehicle interior

Remove dirt and dust using a vacuum cleaner. Wipe dirty surfaces with a cloth dampened with lukewarm water.

Cleaning the leather areas

- Remove dirt and dust using a vacuum cleaner.
- Wipe off any excess dirt and dust with a soft cloth dampened with diluted detergent.
Use a diluted water solution of approximately 5% neutral wool detergent.
- Wring out any excess water from the cloth and thoroughly wipe off all remaining traces of detergent.
- Wipe the surface with a dry, soft cloth to remove any remaining moisture. Allow the leather to dry in a shaded and ventilated area.

Cleaning the synthetic leather areas

- Remove loose dirt using a vacuum cleaner.
- Apply a mild soap solution to the synthetic leather using a sponge or soft cloth.
- Allow the solution to soak in for a few minutes. Remove the dirt and wipe off the solution with a clean, damp cloth.

■ Caring for leather areas

Toyota recommends cleaning the interior of the vehicle at least twice a year to maintain the quality of the vehicle's interior.

■ Shampooing the carpets

There are several commercial foaming-type cleaners available. Use a sponge or brush to apply the foam. Rub in overlapping circles. Do not use water. Wipe dirty surfaces and let them dry. Excellent results are obtained by keeping the carpet as dry as possible.

■ Seat belts

Clean with mild soap and lukewarm water using a cloth or sponge. Also check the belts periodically for excessive wear, fraying or cuts.

**WARNING****■ Water in the vehicle**

- Do not splash or spill liquid in the vehicle.
Doing so may cause electrical components, etc. to malfunction or catch fire.
- Do not get any of the SRS components or wiring in the vehicle interior wet.
(→P. 38)
An electrical malfunction may cause the airbags to deploy or not function properly, resulting in death or serious injury.

■ Cleaning the interior (especially instrument panel)

Do not use polish wax or polish cleaner. The instrument panel may reflect off the windshield, obstructing the driver's view and leading to an accident, resulting in death or serious injury.

**NOTICE****■ Cleaning detergents**

- Do not use the following types of detergent, as they may discolor the vehicle interior or cause streaks or damage to painted surfaces:
 - Non-seat portions: Organic substances such as benzene or gasoline, alkaline or acidic solutions, dye, and bleach
 - Seats: Alkaline or acidic solutions, such as thinner, benzene, and alcohol
- Do not use polish wax or polish cleaner. The instrument panel's or other interior part's painted surface may be damaged.

■ Preventing damage to leather surfaces

Observe the following precautions to avoid damage to and deterioration of leather surfaces:

- Remove any dust or dirt from leather surfaces immediately.
- Do not expose the vehicle to direct sunlight for extended periods of time. Park the vehicle in the shade, especially during summer.
- Do not place items made of vinyl, plastic, or containing wax on the upholstery, as they may stick to the leather surface if the vehicle interior heats up significantly.

■ Water on the floor

Do not wash the vehicle floor with water.

Vehicle systems such as the audio system may be damaged if water comes into contact with electrical components such as the audio system above or under the floor of the vehicle. Water may also cause the body to rust.

■ Cleaning the inside of the rear window

- Do not use glass cleaner to clean the rear window, as this may cause damage to the rear window defogger heater wires. Use a cloth dampened with lukewarm water to gently wipe the window clean. Wipe the window in strokes running parallel to the heater wires.
- Be careful not to scratch or damage the heater wires.

Maintenance requirements

To ensure safe and economical driving, day-to-day care and regular maintenance are essential. Toyota recommends the following maintenance:

Scheduled maintenance

Scheduled maintenance should be performed at specified intervals according to the maintenance schedule.

For full details of your maintenance schedule, refer to the “Toyota Service Booklet” or “Toyota Warranty Booklet”.

Do-it-yourself maintenance

What about do-it-yourself maintenance?

Many of the maintenance items are easy to do yourself if you have a little mechanical ability and a few basic automotive tools.

Note, however, that some maintenance tasks require special tools and skills. These are best performed by qualified technicians. Even if you are an experienced do-it-yourself mechanic, we recommend that repairs and maintenance be conducted by any authorized Toyota dealer or repairer, or another duly qualified and equipped professional. Any authorized Toyota dealer or repairer will keep a record of maintenance, which could be useful should you ever require Warranty Service. Should you choose to select a qualified and equipped professional other than an authorized Toyota repairer to service or maintain your vehicle, we recommend that you request that a record of maintenance be kept.

■ Where to go for the maintenance service?

In order to maintain your vehicle in the best possible condition, Toyota recommends that all repairs and service operations be carried out by authorized Toyota dealers or repairers or other duly qualified and equipped professionals. For repairs and services covered by your warranty, please visit an authorized Toyota dealer or repairer, who will use genuine Toyota parts in repairing any difficulties you may encounter. There can also be advantages in utilizing authorized Toyota dealers or repairers for non-warranty repairs and services, as members of the Toyota network will be able to expertly assist you with any difficulties you may encounter.

Your Toyota dealer or repairer, or another duly qualified and equipped professional will perform all of the scheduled maintenance on your vehicle reliably and economically due to their experience with Toyota vehicles.

■ Does your vehicle need repairs?

Be on the alert for changes in performance and sounds, and visual tip-offs that indicate service is needed. Some important clues are:

- Engine misfire, stumbling or pinging
- Appreciable loss of power
- Strange engine noises
- A fluid leak under the vehicle (However, water dripping from the air conditioning system after use is normal.)
- Change in exhaust sound (This may indicate a dangerous carbon monoxide leak. Drive with the windows open and have the exhaust system checked immediately.)
- Flat-looking tires, excessive tire squeal when cornering, uneven tire wear
- Vehicle pulls to one side when driven straight on a level road
- Strange noises related to suspension movement
- Loss of brake effectiveness, spongy feeling brake pedal or clutch pedal (vehicles with a manual transmission), pedal almost touches the floor, vehicle pulls to one side when braking
- Engine coolant temperature continually higher than normal

If you notice any of these clues, take your vehicle to any authorized Toyota dealer or repairer, or another duly qualified and equipped professional as soon as possible. Your vehicle may need adjustment or repair.

**WARNING****■ If your vehicle is not properly maintained**

Improper maintenance could result in serious damage to the vehicle and possible death or serious injury.

■ Handling of the battery

Battery posts, terminals and related accessories contain lead and lead compounds which are known to cause brain damage. Wash your hands after handling. (→P. 342)

Do-it-yourself service precautions

If you perform maintenance by yourself, be sure to follow the correct procedure as given in these sections.

Items	Parts and tools
Battery condition (→P. 342)	<ul style="list-style-type: none"> • Warm water • Baking soda • Grease • Conventional wrench (for terminal clamp bolts) • Distilled water
Engine coolant level (→P. 340)	<ul style="list-style-type: none"> • “Toyota Super Long Life Coolant” or a similar high quality ethylene glycol-based non-silicate, non-amine, non-nitrite and non-borate coolant with long-life hybrid organic acid technology • “Toyota Super Long Life Coolant” is pre-mixed with 50% coolant and 50% deionized water. • Funnel (used only for adding coolant)
Engine oil level (→P. 335)	<ul style="list-style-type: none"> • “Toyota Genuine Motor Oil” or equivalent • Rag or paper towel • Funnel (used only for adding engine oil)
Fuses (→P. 370)	<ul style="list-style-type: none"> • Fuse with same amperage rating as original
Light bulbs (→P. 376)	<ul style="list-style-type: none"> • Bulb with same number and wattage rating as original • Phillips-head screwdriver • Flathead screwdriver • Wrench
Radiator, condenser and intercooler (→P. 341)	—
Tire inflation pressure (→P. 360)	<ul style="list-style-type: none"> • Tire pressure gauge • Compressed air source
Washer fluid (→P. 345)	<ul style="list-style-type: none"> • Water or washer fluid containing antifreeze (for winter use) • Funnel (used only for adding water or washer fluid)

 **WARNING**

The engine compartment contains many mechanisms and fluids that may move suddenly, become hot, or become electrically energized. To avoid death or serious injury, observe the following precautions.

■ When working on the engine compartment

- Keep hands, clothing and tools away from the moving fan and engine drive belt.
- Be careful not to touch the engine, radiator, exhaust manifold, etc. right after driving as they may be hot. Oil and other fluids may also be hot.
- Do not leave anything that may burn easily, such as paper and rags, in the engine compartment.
- Do not smoke, cause sparks or expose an open flame to fuel on the battery. Fuel and battery fumes are flammable.
- Be extremely cautious when working on the battery. It contains poisonous and corrosive sulfuric acid.
- Take care because brake fluid can harm your hands or eyes and damage painted surfaces. If fluid gets on your hands or in your eyes, flush the affected area with clean water immediately.
If you still experience discomfort, consult a doctor.

■ When working near the electric cooling fan or radiator grille

- ▶ Vehicles without a smart entry & start system

Be sure the engine switch is in the “LOCK” position.

With the engine switch in the “ON” position, the electric cooling fan may automatically start to run if the air conditioning is on and/or the coolant temperature is high. (→P. 341)

- ▶ Vehicles with a smart entry & start system

Be sure the engine switch is off.

With the engine switch in IGNITION ON mode, the electric cooling fan may automatically start to run if the air conditioning is on and/or the coolant temperature is high. (→P. 341)

■ Safety glasses

Wear safety glasses to prevent flying or falling material, fluid spray, etc. from getting in your eyes.

**NOTICE****■ If you remove the air cleaner filter**

Driving with the air cleaner filter removed may cause excessive engine wear due to dirt in the air.

■ If the fluid level is low or high

It is normal for the brake fluid level to go down slightly as the brake pads wear or when the fluid level in the accumulator is high.

If the reservoir needs frequent refilling, it may indicate a serious problem.

Hood

Release the lock from the inside of the vehicle to open the hood.

- 1** Pull the hood lock release lever.
The hood will pop up slightly.

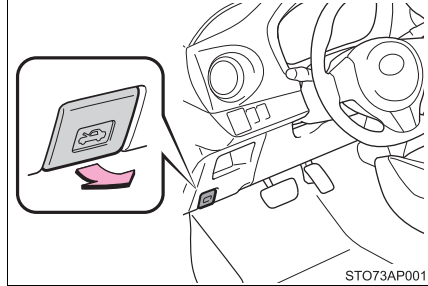

- 2** Pull up the auxiliary catch lever and lift the hood.

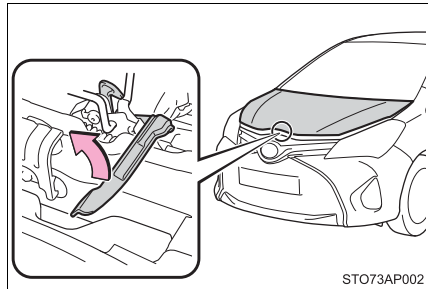

- 3** Hold the hood open by inserting the supporting rod into the slot.

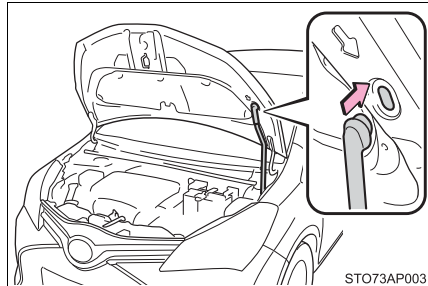

 **WARNING****■ Pre-driving check**

Check that the hood is fully closed and locked.

If the hood is not locked properly, it may open while the vehicle is in motion and cause an accident, which may result in death or serious injury.

■ When opening the hood

Make sure to use the support rod to support the hood when opening it, ensuring that the rod is fixed correctly. The hood may stay open without support on slope, however, it is dangerous because the hood may suddenly close.

 **NOTICE****■ When closing the hood**

Be sure to return the support rod to its clip before closing the hood. Closing the hood without returning the support rod properly could cause the hood to bend.

Positioning a floor jack

When using a floor jack, follow the instructions in the manual provided with the jack and perform the operation safely.

When raising your vehicle with a floor jack, position the jack correctly. Improper placement may damage your vehicle or cause injury.

◆ Front

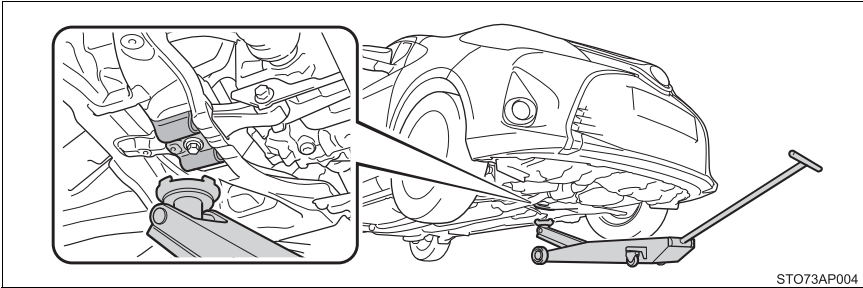

◆ Rear

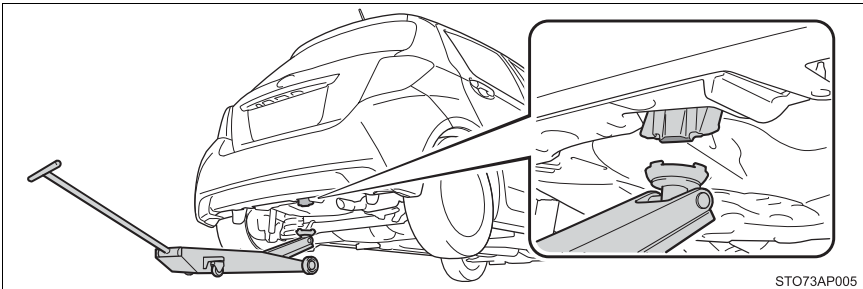

 NOTICE**■ When raising your vehicle**

Do not jack the vehicle at the suspension. The suspension may be damaged.

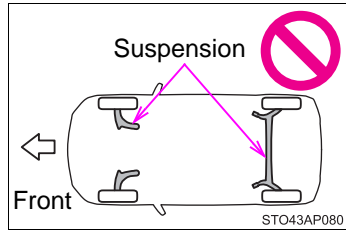

Engine compartment

■ 1KR-FE engine

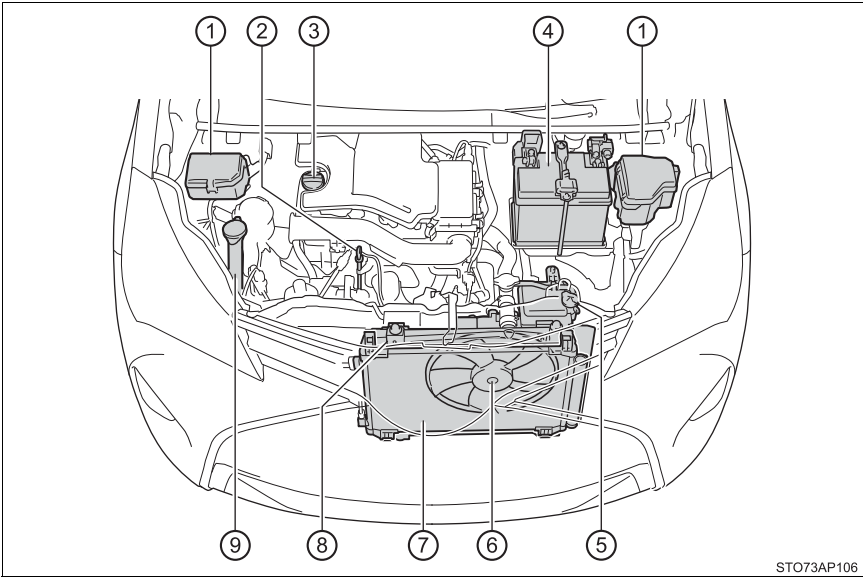

- | | | | |
|-----------------------------|-----------|----------------------------|-----------|
| ① Fuse boxes | (→P. 370) | ⑤ Engine coolant reservoir | (→P. 340) |
| ② Engine oil level dipstick | (→P. 335) | ⑥ Electric cooling fan | |
| ③ Engine oil filler cap | (→P. 337) | ⑦ Condenser | (→P. 341) |
| ④ Battery | (→P. 342) | ⑧ Radiator | (→P. 341) |
| | | ⑨ Washer fluid tank | (→P. 345) |

■ 1NR-FE engine

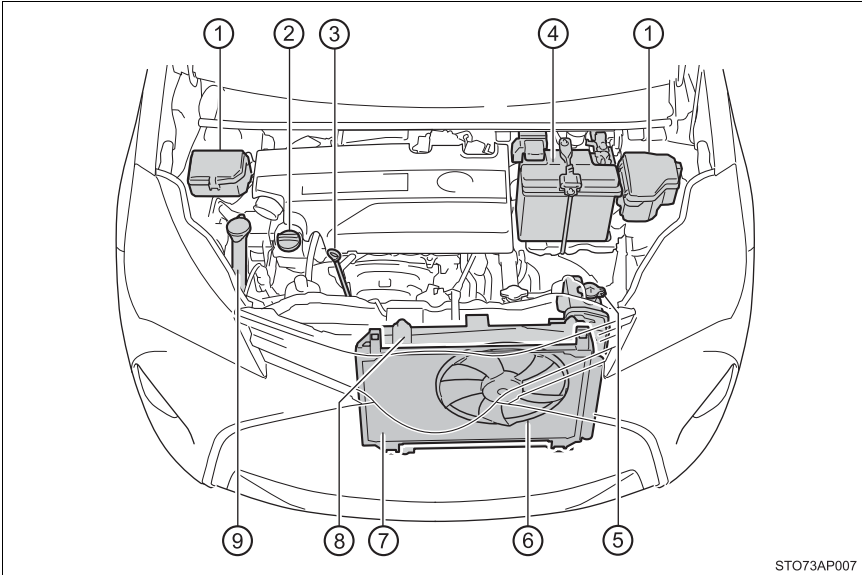

- | | | | |
|-----------------------------|-----------|----------------------------|-----------|
| ① Fuse boxes | (→P. 370) | ⑤ Engine coolant reservoir | (→P. 340) |
| ② Engine oil filler cap | (→P. 337) | ⑥ Electric cooling fan | |
| ③ Engine oil level dipstick | (→P. 335) | ⑦ Condenser | (→P. 341) |
| ④ Battery | (→P. 342) | ⑧ Radiator | (→P. 341) |
| | | ⑨ Washer fluid tank | (→P. 345) |

■ 1ND-TV engine

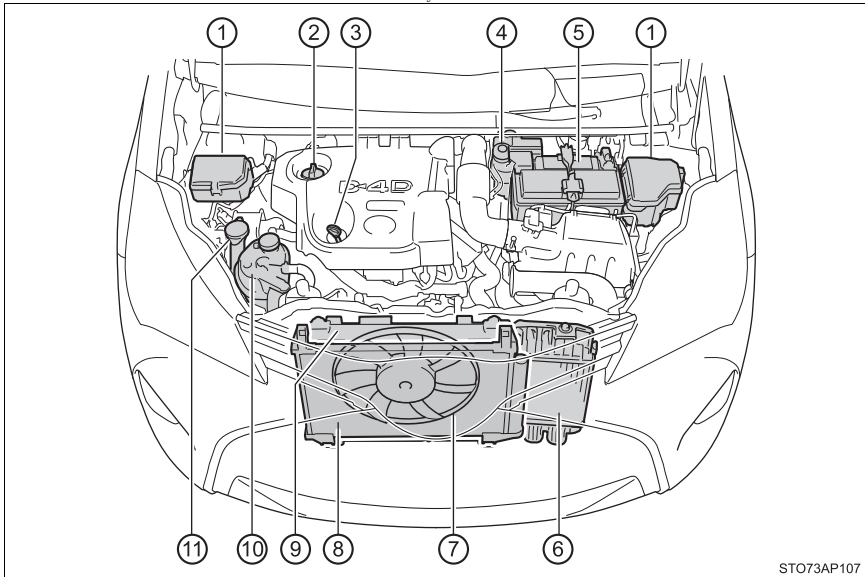

STO73AP107

- | | | | |
|-----------------------------|-----------|----------------------------|-----------|
| ① Fuse boxes | (→P. 370) | ⑥ Intercooler | (→P. 341) |
| ② Engine oil filler cap | (→P. 337) | ⑦ Electric cooling fan | |
| ③ Engine oil level dipstick | (→P. 335) | ⑧ Condenser | (→P. 341) |
| ④ Fuel filter | (→P. 346) | ⑨ Radiator | (→P. 341) |
| ⑤ Battery | (→P. 342) | ⑩ Engine coolant reservoir | (→P. 340) |
| | | ⑪ Washer fluid tank | (→P. 345) |

Engine oil

With the engine at operating temperature and turned off, check the oil level on the dipstick.

■ Checking the engine oil

- 1 Park the vehicle on level ground. After warming up the engine and turning it off, wait more than 5 minutes for the oil to drain back into the bottom of the engine.
- 2 Holding a rag under the end, pull the dipstick out.

▶ 1KR-FE engine

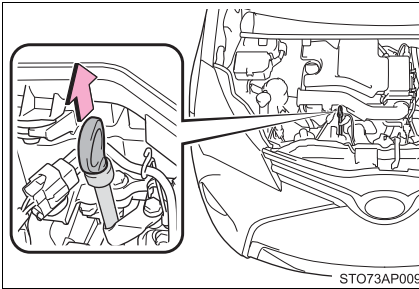

▶ 1NR-FE engine

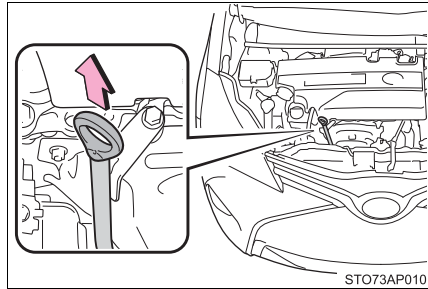

▶ 1ND-TV engine

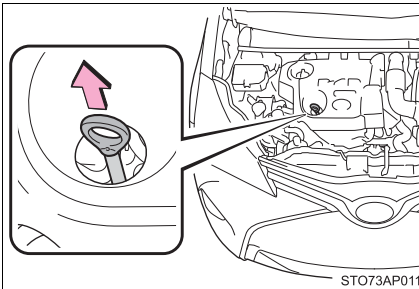

- 3 Wipe the dipstick clean.
- 4 Reinsert the dipstick fully.

5 Holding a rag under the end, pull the dipstick out and check the oil level.

- ① Low
- ② Normal
- ③ Excessive

► Flat dipstick

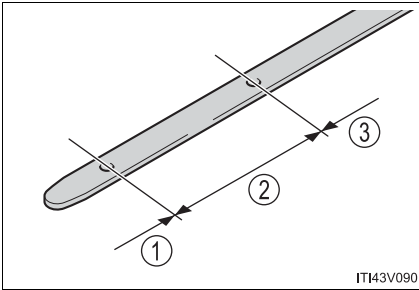

► Non-flat dipstick

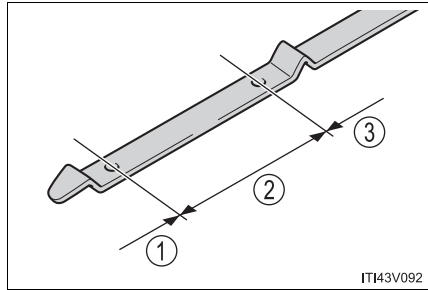

The shape of the dipstick may differ depending on the type of vehicle or engine.

6 Wipe the dipstick and reinsert it fully.

■ Adding engine oil

If the oil level is below or near the low level mark, add engine oil of the same type as that already in the engine.

▶ 1KR-FE engine

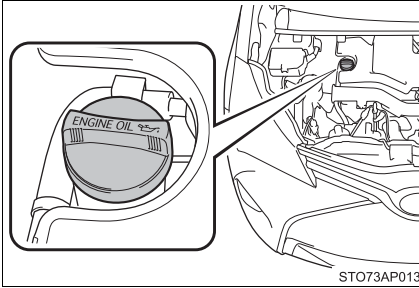

▶ 1NR-FE engine

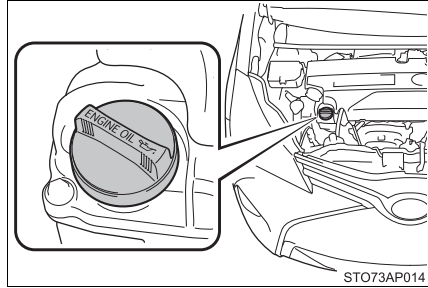

▶ 1ND-TV engine

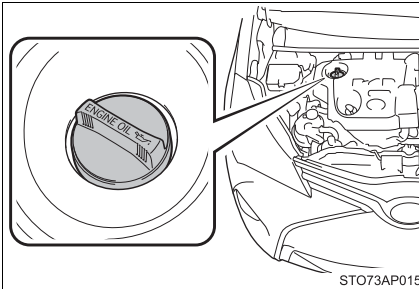

Make sure to check the oil type and prepare the items needed before adding oil.

Engine oil selection	→P. 474
Oil quantity (Low → Full)	<ul style="list-style-type: none"> ▶ 1KR-FE engine 1.3 L (1.4 qt., 1.1 Imp.qt.) ▶ 1NR-FE and 1ND-TV engines 1.5 L (1.6 qt., 1.3 Imp.qt.)
Items	Clean funnel

- 1 Remove the oil filler cap by turning it counterclockwise.
- 2 Add engine oil slowly, checking the dipstick.
- 3 Install the oil filler cap by turning it clockwise.

■ Engine oil consumption

A certain amount of engine oil will be consumed while driving. In the following situations, oil consumption may increase, and engine oil may need to be refilled in between oil maintenance intervals.

- When the engine is new, for example directly after purchasing the vehicle or after replacing the engine
- If low quality oil or oil of an inappropriate viscosity is used
- When driving at high engine speeds or with a heavy load, when towing (except for South Africa), or when driving while accelerating or decelerating frequently
- When leaving the engine idling for a long time, or when driving frequently through heavy traffic

■ After changing the engine oil (diesel engine only)

The engine oil maintenance data should be reset. Perform the following procedures:

- 1 Switch the display to the trip meter "A" when the engine is running.
(→P. 91)
- 2 Turn the engine switch to the "LOCK" position (vehicles without a smart entry & start system) or off (vehicles with a smart entry & start system).
- 3 Vehicles without a smart entry & start system:

While pressing the display change button (→P. 91), turn the engine switch to the "ON" position (do not start the engine because reset mode will be canceled). Continue to press and hold the button until the trip meter displays "000000".

Vehicles with a smart entry & start system:

While pressing the display change button (→P. 91), turn the engine switch to the IGNITION ON mode (do not start the engine because otherwise the reset mode will be canceled). Continue to press and hold the button until the trip meter displays "000000".

 **WARNING**
■ Used engine oil

- Used engine oil contains potentially harmful contaminants which may cause skin disorders such as inflammation and skin cancer, so care should be taken to avoid prolonged and repeated contact. To remove used engine oil from your skin, wash thoroughly with soap and water.
- Dispose of used oil and filters only in a safe and acceptable manner. Do not dispose of used oil and filters in household trash, in sewers or onto the ground.
Call any authorized Toyota dealer or repairer, or another duly qualified and equipped professional, service station or auto parts store for information concerning recycling or disposal.
- Do not leave used engine oil within the reach of children.

 **NOTICE**
■ To prevent serious engine damage

Check the oil level on a regular basis.

■ When replacing the engine oil

- Be careful not to spill engine oil on the vehicle components.
- Avoid overfilling, or the engine could be damaged.
- Check the oil level on the dipstick every time you refill the vehicle.
- Be sure the engine oil filler cap is properly tightened.

■ Engine oil (vehicles with a DPF system*)

Using an engine oil other than ACEA C2 may damage the catalytic converter.

*: To determine whether or not your vehicle has a DPF system, contact any authorized Toyota dealer or repairer, or another duly qualified and equipped professional.

Engine coolant

The coolant level is satisfactory if it is between the “FULL” and “LOW” lines on the reservoir when the engine is cold.

▶ Gasoline engine

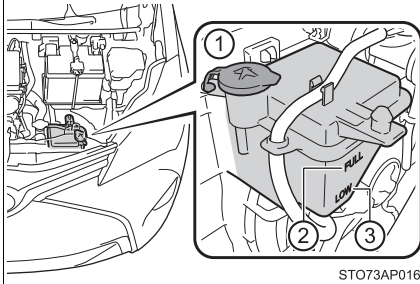

▶ Diesel engine

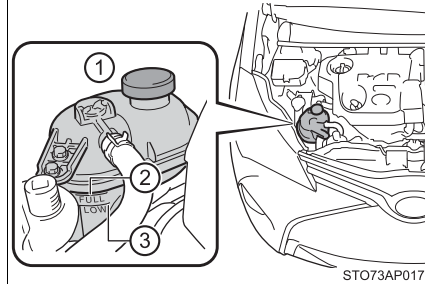

- ① Reservoir cap
- ② “FULL” line
- ③ “LOW” line

If the level is on or below the “LOW” line, add coolant up to the “FULL” line. (→P. 458)

■ Coolant selection

Only use “Toyota Super Long Life Coolant” or a similar high quality ethylene glycol based non-silicate, non-amine, non-nitrite, and non-borate coolant with long-life hybrid organic acid technology.

“Toyota Super Long Life Coolant” is a mixture of 50% coolant and 50% deionized water. (Minimum temperature: -35°C [-31°F])

For more details about coolant, contact any authorized Toyota dealer or repairer, or another duly qualified and equipped professional.

■ If the coolant level drops within a short time of replenishing

Visually check the radiator, hoses, engine coolant reservoir caps, drain cock and water pump.

If you cannot find a leak, have any authorized Toyota dealer or repairer, or another duly qualified and equipped professional test the cap and check for leaks in the cooling system.

 **WARNING**

■ **When the engine is hot**

Do not remove the radiator cap (gasoline engine), or the engine coolant reservoir cap (diesel engine).
The cooling system may be under pressure and may spray hot coolant if the cap is removed, causing serious injuries, such as burns.

 **NOTICE**

■ **When adding coolant**

Coolant is neither plain water nor straight antifreeze. The correct mixture of water and antifreeze must be used to provide proper lubrication, corrosion protection and cooling. Be sure to read the antifreeze or coolant label.

■ **If you spill coolant**

Be sure to wash it off with water to prevent it from damaging parts or paint.

Radiator, condenser and intercooler

Check the radiator, condenser and intercooler and clear away any foreign objects.

If any of the above parts is extremely dirty or you are not sure of their condition, have your vehicle inspected by any authorized Toyota dealer or repairer, or another duly qualified and equipped professional.

 **WARNING**

■ **When the engine is hot**







Do not touch the radiator, condenser or intercooler as they may be hot and cause serious injuries, such as burns.

Battery

Check the battery as follows.

■ Caution symbols

The meanings of each caution symbol on the top of the battery are as follows:

	No smoking, no naked flames, no sparks		Battery acid
	Shield eyes		Note operating instructions
	Keep away from children		Explosive gas

■ Battery exterior

Make sure that the battery terminals are not corroded and that there are no loose connections, cracks, or loose clamps.

- ① Terminals
- ② Hold-down clamp

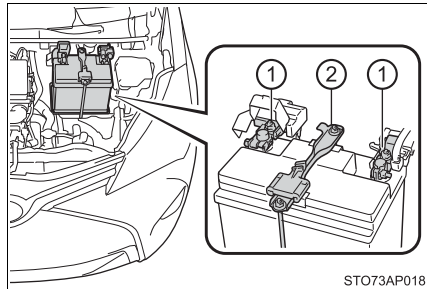

STO73AP018

■ Before recharging

When recharging, the battery produces hydrogen gas which is flammable and explosive. Therefore, observe the following before recharging:

- If recharging with the battery installed on the vehicle, be sure to disconnect the ground cable.
- Make sure the power switch on the charger is off when connecting and disconnecting the charger cables to the battery.

■ After recharging/reconnecting the battery (vehicles with a smart entry & start system)

- Unlocking the doors using the smart entry & start system may not be possible immediately after reconnecting the battery. If this happens, use the wireless remote control or the mechanical key to lock/unlock the doors.
- Start the engine with the engine switch in ACCESSORY mode. The engine may not start with the engine switch turned off. However, the engine will operate normally from the second attempt.
- The engine switch mode is recorded by the vehicle. If the battery is reconnected, the vehicle will return the engine switch mode to the status it was in before the battery was disconnected. Make sure to turn off the engine before disconnect the battery. Take extra care when connecting the battery if the engine switch mode prior to discharge is unknown.

If the engine will not start even after multiple attempts, contact any authorized Toyota dealer or repairer, or another duly qualified and equipped professional.



WARNING

■ Chemicals in the battery

Batteries contain poisonous and corrosive sulfuric acid and may produce hydrogen gas which is flammable and explosive. To reduce the risk of death or serious injury, take the following precautions while working on or near the battery:

- Do not cause sparks by touching the battery terminals with tools.
- Do not smoke or light a match near the battery.
- Avoid contact with eyes, skin and clothes.
- Never inhale or swallow electrolyte.
- Wear protective safety glasses when working near the battery.
- Keep children away from the battery.

**WARNING****■ Where to safely charge the battery**

Always charge the battery in an open area. Do not charge the battery in a garage or closed room where there is insufficient ventilation.

■ How to recharge the battery

Only perform a slow charge (5 A or less). The battery may explode if charged at a quicker rate.

■ Emergency measures regarding electrolyte

- If electrolyte gets in your eyes
Flush your eyes with clean water for at least 15 minutes and get immediate medical attention. If possible, continue to apply water with a sponge or cloth while traveling to the nearest medical facility.
- If electrolyte gets on your skin
Wash the affected area thoroughly. If you feel pain or burning, get medical attention immediately.
- If electrolyte gets on your clothes
It can soak through clothing on to your skin. Immediately take off the clothing and follow the procedure above if necessary.
- If you accidentally swallow electrolyte
Drink a large quantity of water or milk. Get emergency medical attention immediately.

**NOTICE****■ When recharging the battery**

Never recharge the battery while the engine is running. Also, be sure all accessories are turned off.

Washer fluid

If the washer fluid level is less than “FULL” line, add washer fluid to “FULL” line.

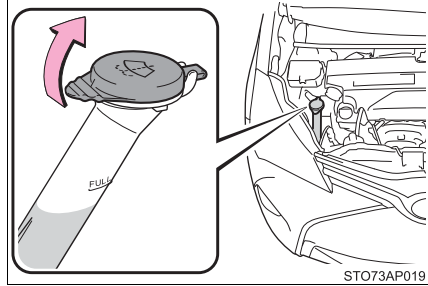

WARNING

■ When adding washer fluid

Do not add washer fluid when the engine is hot or running as washer fluid contains alcohol and may catch fire if spilled on the engine etc.

NOTICE

■ Do not use any fluid other than washer fluid

Do not use soapy water or engine antifreeze instead of washer fluid. Doing so may cause streaking on the vehicle's painted surfaces.

■ Diluting washer fluid

Dilute washer fluid with water as necessary. Refer to the freezing temperatures listed on the label of the washer fluid bottle.

Fuel filter (diesel engine)

You may drain the fuel filter yourself. However, as the operation is difficult, we recommend having it drained by any authorized Toyota dealer or repairer, or another duly qualified and equipped professional. Even if you decide to drain it yourself, contact any authorized Toyota dealer or repairer, or another duly qualified and equipped professional.

The water in the fuel filter needs to be drained if the fuel filter warning light comes on. (→P. 407)

- 1 Turn the engine switch to the "LOCK" position (vehicles without a smart entry & start system) or off (vehicles with a smart entry & start system).
- 2 Place a small tray under the drain plug to catch the water and any fuel that comes out.
- 3 Turn the drain plug counter-clockwise about 2 to 2 1/2 turns.

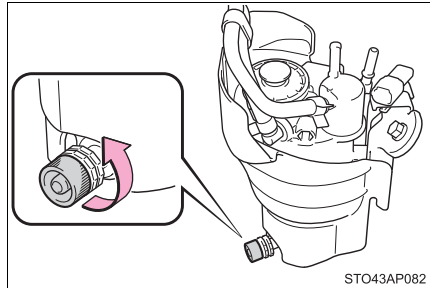

- 4 Operate the priming pump until fuel begins to run out.

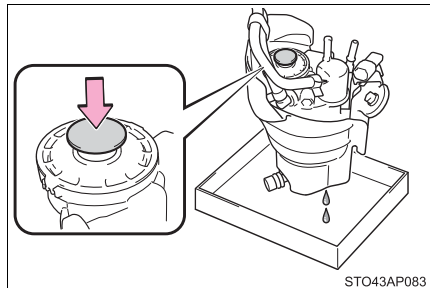

- 5 After draining, tighten the drain plug by hand.

Tires

Replace or rotate tires in accordance with maintenance schedules and treadwear.

Checking tires

- ① New tread
- ② Treadwear indicator
- ③ Worn tread

The location of treadwear indicators is shown by the “TWI” or “Δ” marks, etc., molded on the sidewall of each tire.

Check spare tire condition and pressure if not rotated.

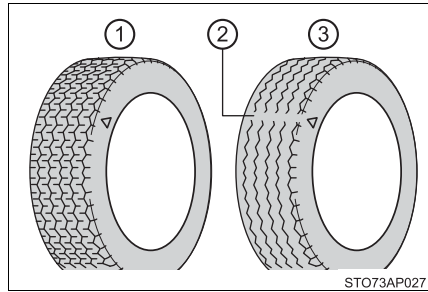

STO73AP027

Tire rotation

Rotate the tires in the order shown.

- ▶ Vehicles with a spare tire of different wheel type from the installed tires or an emergency tire puncture repair kit
- ▶ Vehicles with a spare tire of the same wheel type as the installed tires

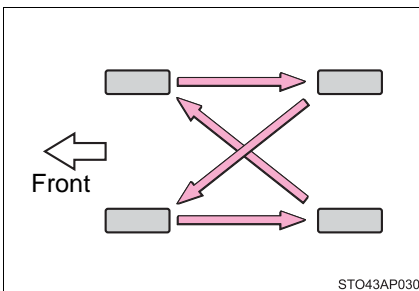

STO43AP030

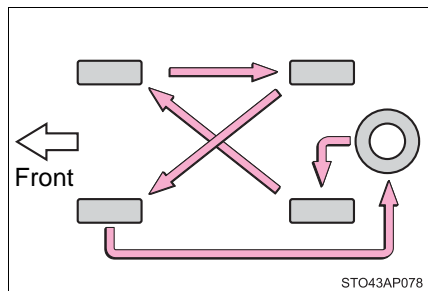

STO43AP078

To equalize tire wear and help extend tire life, Toyota recommends that tire rotation is carried out approximately every 10000 km (6000 miles).

Tire pressure warning system (if equipped)

Your vehicle is equipped with a tire pressure warning system that uses tire pressure warning valves and transmitters to detect low tire inflation pressure before serious problems arise.

If the tire pressure drops below a predetermined level, the driver is warned by a warning light. (→P. 408)

Installing tire pressure warning valves and transmitters (vehicles with a tire pressure warning system)

When replacing tires or wheels, tire pressure warning valves and transmitters must also be installed.

When new tire pressure warning valves and transmitters are installed, new ID codes must be registered in the tire pressure warning computer and the tire pressure warning system must be initialized. Have tire pressure warning valve and transmitter ID codes registered by any authorized Toyota dealer or repairer, or another duly qualified and equipped professional. (→P. 350)

Initializing the tire pressure warning system (vehicles with a tire pressure warning system)

■ The tire pressure warning system must be initialized in the following circumstances:

- When rotating front and rear tires which have different tire inflation pressures
- When the tire inflation pressure is changed such as when changing traveling speed
- When changing the tire size

When the tire pressure warning system is initialized, the current tire inflation pressure is set as the benchmark pressure.

■ How to initialize the tire pressure warning system (vehicles with a tire pressure warning system)

- 1 Park the vehicle in a safe place and turn the engine switch to the “LOCK” position (vehicles without a smart entry & start system) or off (vehicles with a smart entry & start system).

Initialization cannot be performed while the vehicle is moving.

- 2 Adjust the tire inflation pressure to the specified cold tire inflation pressure level. (→P. 483)

Make sure to adjust the tire pressure to the specified cold tire inflation pressure level. The tire pressure warning system will operate based on this pressure level.

- 3 Turn the engine switch to the “ON” position (vehicles without a smart entry & start system) or IGNITION ON mode (vehicles with a smart entry & start system).

- 4 Press and hold the tire pressure warning reset switch until the tire pressure warning light blinks slowly 3 times.

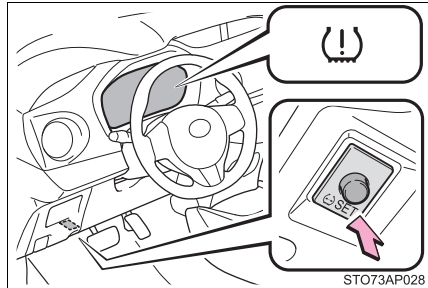

- 5 Vehicles without a smart entry & start system: Wait for a few minutes with the engine switch in the “ON” position and then turn the engine switch to the “ACC” or “LOCK” position.

Vehicles with a smart entry & start system: Wait for a few minutes with the engine switch in IGNITION ON mode and then turn the engine switch off.

Registering ID codes (vehicles with a tire pressure warning system)

The tire pressure warning valve and transmitter is equipped with a unique ID code. When replacing a tire pressure warning valve and transmitter, it is necessary to register the ID code. Have the ID code registered by any authorized Toyota dealer or repairer, or another duly qualified and equipped professional.

■ When to replace your vehicle's tires

Tires should be replaced if:

- You have tire damage such as cuts, splits, cracks deep enough to expose the fabric, and bulges indicating internal damage
- A tire goes flat repeatedly or cannot be properly repaired due to the size or location of a cut or other damage

If you are not sure, consult with any authorized Toyota dealer or repairer, or another duly qualified and equipped professional.

■ Replacing tire and wheels (vehicles with a tire pressure warning system)

If the ID code of the tire pressure warning valve and transmitter is not registered, the tire pressure warning system will not work properly. After driving for about 10 minutes, the tire pressure warning light blinks for 1 minute and stays on to indicate a system malfunction.

■ Tire life

Any tire over 6 years old must be checked by a qualified technician even if it has seldom or never been used or damage is not obvious.

■ Low profile tires (vehicles with 195/50R16 tires)

Generally, low profile tires will wear more rapidly and tire grip performance will be reduced on snowy and/or icy roads when compared to standard tires. Be sure to use snow tires or tire chains on snowy and/or icy roads and drive carefully at a speed appropriate for road and weather conditions.

■ **Routine tire inflation pressure checks (vehicles with a tire pressure warning system)**

The tire pressure warning system does not replace routine tire inflation pressure checks. Make sure to check tire inflation pressure as part of your routine of daily vehicle checks.

■ **Initializing the tire pressure warning system (vehicles with a tire pressure warning system)**

Initialize the system with the tire inflation pressure adjusted to the specified level.

■ **If the tread on snow tires wears down below 4 mm (0.16 in.)**

The effectiveness of the tires as snow tires is lost.

■ **When initialization of the tire pressure warning system has failed (vehicles with a tire pressure warning system)**

Initialization can be completed in a few minutes. However, in the following cases, the settings have not been recorded and the system will not operate properly. If repeated attempts to record tire inflation pressure settings are unsuccessful, have the vehicle inspected by any authorized Toyota dealer or repairer, or another duly qualified and equipped professional.

- When operating the tire pressure warning reset switch, the tire pressure warning light does not blink 3 times.
- After driving for a certain period of time since the initialization has been completed, the warning light comes on after blinking for 1 minute.

■ Certification for the tire pressure warning system

The latest “DECLARATION of CONFORMITY” (DoC) is available at the following address:

<http://www.globaldenso.com/en/products/oem/index.html>



<p>Hereby, DENSO CORPORATION declares that this 23AAM is in compliance with the essential requirements and other relevant provisions of Directive 1999/5/EC.</p>
<p>DENSO CORPORATION vakuuttaa täten että 23AAM tyyppinen laite on direktiivin 1999/5/EY oleellisten vaatimusten ja sitä koskevien direktiivin muiden ehtojen mukainen.</p>
<p>Hierbij verklaart DENSO CORPORATION dat het toestel 23AAM in overeenstemming is met de essentiële eisen en de andere relevante bepalingen van richtlijn 1999/5/EG.</p>
<p>Par la présente DENSO CORPORATION déclare que l'appareil 23AAM est conforme aux exigences essentielles et aux autres dispositions pertinentes de la directive 1999/5/CE.</p>
<p>Härmed intygar DENSO CORPORATION att denna 23AAM står i överensstämmelse med de väsentliga egenskapskrav och övriga relevanta bestämmelser som framgår av direktiv 1999/5/EG.</p>
<p>Undertegnede DENSO CORPORATION erklærer herved, at følgende udstyr 23AAM overholder de væsentlige krav og øvrige relevante krav i direktiv 1999/5/EF.</p>
<p>Hiermit erklart DENSO CORPORATION, dass sich das Gerät 23AAM in Übereinstimmung mit den grundlegenden Anforderungen und den übrigen einschlägigen Bestimmungen der Richtlinie 1999/5/EG befindet.</p>
<p>ΜΕ ΤΗΝ ΠΑΡΟΥΣΑ DENSO CORPORATION ΔΗΛΩΝΕΙ ΟΤΙ 23ΑΑΜ ΣΥΜΜΟΡΦΩΝΕΤΑΙ ΠΡΟΣ ΤΙΣ ΟΥΣΙΩΔΕΙΣ ΑΠΑΙΤΗΣΕΙΣ ΚΑΙ ΤΙΣ ΛΟΙΠΕΣ ΣΧΕΤΙΚΕΣ ΔΙΑΤΑΞΕΙΣ ΤΗΣ ΟΔΗΓΙΑΣ 1999/5/ΕΚ.</p>
<p>Con la presente DENSO CORPORATION dichiara che questo 23AAM è conforme ai requisiti essenziali ed alle altre disposizioni pertinenti stabilite dalla direttiva 1999/5/CE.</p>
<p>Por medio de la presente DENSO CORPORATION declara que el 23AAM cumple con los requisitos esenciales y cualesquiera otras disposiciones aplicables o exigibles de la Directiva 1999/5/CE.</p>

DENSO CORPORATION declara que este 23AAM está conforme com os requisitos essenciais e outras disposições da Directiva 1999/5/CE.
Hawnekk, DENSO CORPORATION, jiddikjara li dan 23AAM jikkonforma mal-htigijiet essenzjali u ma provvedimentli oħrajn relevanti li hemm fid-Dirrettiva 1999/5/EC.
Käesolevaga kinnitab DENSO CORPORATION seadme 23AAM vastavust direktiivi 1999/5/EÜ põhinõuetele ja nimetatud direktiivist tulenevatele teistele asjakohastele sätetele.
Alulírott, DENSO CORPORATION nyilatkozom, hogy a 23AAM megfelel a vonatkozó alapvető követelményeknek és az 1999/5/EC irányelv egyéb előírásainak.
DENSO CORPORATION týmto vyhlasuje, že 23AAM spĺňa základné požiadavky a všetky príslušné ustanovenia Smernice 1999/5/ES.
DENSO CORPORATION tímto prohlašuje, že tento 23AAM je ve shodě se základními požadavky a dalšími příslušnými ustanoveními směrnice 1999/5/ES.
DENSO CORPORATION izjavlja, da je ta 23AAM v skladu z bistvenimi zahtevami in ostalimi relevantnimi določili direktive 1999/5/ES.
Šiuo DENSO CORPORATION deklaruoja, kad šis 23AAM atitinka esminius reikalavimus ir kitas 1999/5/EB Direktyvos nuostatas.
Ar šo DENSO CORPORATION deklarē, ka 23AAM atbilst Direktīvas 1999/5/EK būtiskajām prasībām un citiem ar to saistītajiem noteikumiem.
Niniejszym DENSO CORPORATION oświadcza, że 23AAM jest zgodny z zasadniczymi wymogami oraz pozostałymi stosownymi postanowieniami Dyrektywy 1999/5/EC.

<p>Hér með lýsir DENSO CORPORATION yfir því að 23AAM er í samræmi við grunnkröfur og aðrar kröfur, sem gerðar eru í tilskipun 1999/5/EC.</p>
<p>DENSO CORPORATION erklærer herved at udstyret 23AAM er i samsvar med de grundlæggende krav og øvrige relevante krav i direktiv 1999/5/EF.</p>
<p>С настоящето, DENSO CORPORATION, декларира, че 23AAM е в съответствие със съществените изисквания и другите приложими разпоредби на Директива 1999/5/EC.</p>
<p>Prin prezenta, DENSO CORPORATION, declară că aparatul 23AAM este în conformitate cu cerințele esențiale și cu alte prevederi pertinente ale Directivei 1999/5/CE.</p>
<p>Ovim, DENSO CORPORATION, izjavljuje da ovaj 23AAM je usklađen sa bitnim zahtjevima i drugim relevantnim odredbama Direktive 1999/5/EC.</p>
<p>Ovim, DENSO CORPORATION, deklarirše da je 23AAM u skladu sa osnovnim zahtevima i ostalim relevantnim odredbama Direktive 1999/5/EC.</p>
<p>Ovim DENSO CORPORATION, izjavljuje da je 23AAM u skladu s bitnim zahtjevima i drugim relevantnim odredbama Direktive 1999/5/EC i Pravilnika o RITT opremi (NN 25/2012).</p>

The latest “DECLARATION of CONFORMITY” (DoC) is available at the following:

DoC address: <http://www.pacific-ind.co.jp/eng/products/car/tpms/doc/>

C € 0891

<p>Hereby, PACIFIC INDUSTRIAL CO.,LTD., declares that this PMV-C210 is in compliance with the essential requirements and other relevant provisions of Directive 1999/5/EC.</p>
<p>PACIFIC INDUSTRIAL CO.,LTD. vakuuttaa täten että PMV-C210 tyyppinen laite on direktiivin 1999/5/EY oleellisten vaatimusten ja sitä koskevien direktiivin muiden ehtojen mukainen.</p>
<p>Hierbij verklaart PACIFIC INDUSTRIAL CO.,LTD. dat het toestel PMV-C210 in overeenstemming is met de essentiële eisen en de andere relevante bepalingen van richtlijn 1999/5/EG.</p>
<p>Par la présente PACIFIC INDUSTRIAL CO.,LTD. déclare que l'appareil PMV-C210 est conforme aux exigences essentielles et aux autres dispositions pertinentes de la directive 1999/5/CE.</p>
<p>Härmed intygar PACIFIC INDUSTRIAL CO.,LTD. att denna PMV-C210 står i överensstämmelse med de väsentliga egenskapskrav och övriga relevanta bestämmelser som framgår av direktiv 1999/5/EG.</p>
<p>Undertegnede PACIFIC INDUSTRIAL CO.,LTD. erklærer herved, at følgende udstyr PMV-C210 overholder de væsentlige krav og øvrige relevante krav i direktiv 1999/5/EF.</p>
<p>Hiermit erklärt PACIFIC INDUSTRIAL CO.,LTD., dass sich das Gerät PMV-C210 in Übereinstimmung mit den grundlegenden Anforderungen und den übrigen einschlägigen Bestimmungen der Richtlinie 1999/5/EG befindet.</p>
<p>ΜΕ ΤΗΝ ΠΑΡΟΥΣΑ PACIFIC INDUSTRIAL CO.,LTD. ΔΗΛΩΝΕΙ ΟΤΙ PMV-C210 ΣΥΜΜΟΡΦΩΝΕΤΑΙ ΠΡΟΣ ΤΙΣ ΟΥΣΙΩ ΔΕΙΞ ΑΠΑΙΤΗΣΕΙΣ ΚΑΙ ΤΙΣ ΛΟΙΠΕΣ ΣΧΕΤΙΚΕΣ ΔΙΑΤΑΞΕΙΣ ΤΗΣ ΟΔΗΓΙΑΣ 1999/5/ΕΚ.</p>
<p>Con la presente PACIFIC INDUSTRIAL CO.,LTD. dichiara che questo PMV-C210 è conforme ai requisiti essenziali ed alle altre disposizioni pertinenti stabilite dalla direttiva 1999/5/CE.</p>
<p>Por medio de la presente PACIFIC INDUSTRIAL CO.,LTD. declara que el PMV-C210 cumple con los requisitos esenciales y cualesquiera otras disposiciones aplicables o exigibles de la Directiva 1999/5/CE.</p>

<p>PACIFIC INDUSTRIAL CO.,LTD. declara que este PMV-C210 está conforme com os requisitos essenciais e outras disposições da Directiva 1999/5/CE.</p>
<p>Hawnhekk, PACIFIC INDUSTRIAL CO.,LTD., jiddkjara li dan PMV-C210 jikkonforma mal-htigijiet essenzjali u ma provvedimentu oħrajn relevanti li hemm fid-Direttiva 1999/5/EC.</p>
<p>Käesolevaga kinnitab PACIFIC INDUSTRIAL CO.,LTD. seadme PMV-C210 vastavust direktiivi 1999/5/EÜ põhinõuetele ja nimetatud direktiivist tulenevatele teistele asjakohastele sätetele.</p>
<p>Alulirott, PACIFIC INDUSTRIAL CO.,LTD. nyilatkozom, hogy a PMV-C210 megfelel a vonatkozó alapvető követelményeknek és az 1999/5/EC irányelv egyéb előírásainak.</p>
<p>PACIFIC INDUSTRIAL CO.,LTD. týmto vyhlasuje, že PMV-C210 splňa základné požiadavky a všetky príslušné ustanovenia Smernice 1999/5/ES.</p>
<p>PACIFIC INDUSTRIAL CO.,LTD. tímto prohlašuje, že tento PMV-C210 je ve shodě se základními požadavky a dalšími příslušnými ustanoveními směrnice 1999/5/ES.</p>
<p>PACIFIC INDUSTRIAL CO.,LTD. izjavlja, da je ta PMV-C210 v skladu z bistvenimi zahtevami in ostalimi relevantnimi določili direktive 1999/5/ES.</p>
<p>Šiuo PACIFIC INDUSTRIAL CO.,LTD. deklaruoja, kad šis PMV-C210 atitinka esminius reikalavimus ir kitas 1999/5/EB Direktyvos nuostatas.</p>
<p>Ar šo PACIFIC INDUSTRIAL CO.,LTD. deklarē, ka PMV-C210 atbilst Direktīvas 1999/5/EK būtiskajām prasībām un citiem ar to saistītajiem noteikumiem.</p>
<p>Niniejszym PACIFIC INDUSTRIAL CO.,LTD. oświadcza, że PMV-C210 jest zgodny z zasadniczymi wymogami oraz pozostałymi stosownymi postanowieniami Dyrektywy 1999/5/EC.</p>

<p>Hér með lýsir PACIFIC INDUSTRIAL CO.,LTD. yfir því að PMV-C210 er í samræmi við grunnkröfur og aðrar kröfur, sem gerðar eru í tilskipun 1999/5/EC.</p>
<p>PACIFIC INDUSTRIAL CO.,LTD. erklærer herved at utstyret PMV-C210 er i samsvar med de grunnleggende krav og øvrige relevante krav i direktiv 1999/5/EF.</p>
<p>С настоящето, PACIFIC INDUSTRIAL CO.,LTD., декларира, че PMV-C210 е в съответствие със съществените изисквания и другите приложими разпоредби на Директива 1999/5/EC.</p>
<p>Prin prezenta, PACIFIC INDUSTRIAL CO.,LTD., declară că aparatul PMV-C210 este în conformitate cu cerințele esențiale și cu alte prevederi pertinente ale Directivei 1999/5/CE.</p>
<p>Ovim , PACIFIC INDUSTRIAL CO.,LTD., izjavjuje da ovaj PMV-C210 je usklađen sa bitnim zahtjevima i drugim relevantnim odredbama Direktive 1999/5/EC.</p>
<p>Ovim PACIFIC INDUSTRIAL CO.,LTD., izjavjuje da je PMV-C210 u skladu s bitnim zahtjevima i drugim relevantnim odredbama Direktive 1999/5/EC .</p>
<p>Me anë të kësaj, PACIFIC INDUSTRIAL CO, LTD., Deklaron se ky PMV-C210 është në përputhje me kërkesat themelore dhe dispozitat e tjera përkatëse të direktivës 1999/5/EC.</p>

**WARNING****■ When inspecting or replacing tires**

Observe the following precautions to prevent accidents.

Failure to do so may cause damage to parts of the drive train as well as dangerous handling characteristics, which may lead to an accident resulting in death or serious injury.

- Do not mix tires of different makes, models or tread patterns.
Also, do not mix tires of remarkably different treadwear.
- Do not use tire sizes other than those recommended by Toyota.
- Do not mix differently constructed tires (radial, bias-belted or bias-ply tires).
- Do not mix summer, all season and snow tires.
- Do not use tires that have been used on another vehicle.
Do not use tires if you do not know how they were used previously.
- Vehicles with a compact spare tire: Do not tow if your vehicle has a compact spare tire installed.

■ When initializing the tire pressure warning system (vehicles with a tire pressure warning system)

Do not operate the tire pressure warning reset switch without first adjusting the tire inflation pressure to the specified level. Otherwise, the tire pressure warning light may not come on even if the tire inflation pressure is low, or it may come on when the tire inflation pressure is actually normal.

**NOTICE****■ Repairing or replacing tires, wheels, tire pressure warning valves, transmitters and tire valve caps (vehicles with a tire pressure warning system)**

- When removing or fitting the wheels, tires or the tire pressure warning valves and transmitters, contact any authorized Toyota dealer or repairer, or another duly qualified and equipped professional as the tire pressure warning valves and transmitters may be damaged if not handled correctly.
- Make sure to install the tire valve caps. If the tire valve caps are not installed, water could enter the tire pressure warning valves and the tire pressure warning valves could be bound.
- When replacing tire valve caps, do not use tire valve caps other than those specified. The cap may become stuck.

 NOTICE**■ To avoid damage to the tire pressure warning valves and transmitters (vehicles with a tire pressure warning system)**

When a tire is repaired with liquid sealants, the tire pressure warning valve and transmitter may not operate properly. If a liquid sealant is used, contact any authorized Toyota dealer or repairer, or another duly qualified and equipped professional or other qualified service shop as soon as possible. Make sure to replace the tire pressure warning valve and transmitter when replacing the tire. (→P. 348)

■ Driving on rough roads

Take particular care when driving on roads with loose surfaces or potholes. These conditions may cause losses in tire inflation pressure, reducing the cushioning ability of the tires. In addition, driving on rough roads may cause damage to the tires themselves, as well as the vehicle's wheels and body.

■ Low profile tires (vehicles with 195/50R16 tires)

Low profile tires may cause greater damage than usual to the tire wheel when sustaining impact from the road surface. Therefore, pay attention to the following:

- Be sure to use proper tire inflation pressure. If tires are under-inflated, they may be damaged more severely.
- Avoid potholes, uneven pavement, curbs and other road hazards. Failure to do so may lead to severe tire and wheel damage.

■ If tire inflation pressure of each tire becomes low while driving

Do not continue driving, or your tires and/or wheels may be ruined.

Tire inflation pressure

Make sure to maintain proper tire inflation pressure. Tire inflation pressure should be checked at least once per month. However, Toyota recommends that tire inflation pressure be checked once every two weeks. (→P. 483)

■ Effects of incorrect tire inflation pressure

Driving with incorrect tire inflation pressure may result in the following:

- Reduced fuel efficiency
- Reduced driving comfort and tire life
- Reduced safety
- Damage to the drive train

If a tire needs frequent inflating, have it checked by any authorized Toyota dealer or repairer, or another duly qualified and equipped professional.

■ Instructions for checking tire inflation pressure

When checking tire inflation pressure, observe the following:

- Check only when the tires are cold.
If your vehicle has been parked for at least 3 hours or has not been driven for more than 1.5 km or 1 mile, you will get an accurate cold tire inflation pressure reading.
- Always use a tire pressure gauge.
The appearance of the tire can be misleading. In addition, tire inflation pressure that is even just a few pounds off can affect ride quality and handling.
- Do not reduce tire inflation pressure after driving. It is normal for tire inflation pressure to be higher after driving.
- Never exceed the vehicle capacity weight.
Passengers and luggage weight should be placed so that the vehicle is balanced.

 **WARNING****■ Proper inflation is critical to save tire performance**

Keep your tires properly inflated. Otherwise, the following conditions may occur and result in an accident causing death or serious injury:

- Excessive wear
- Uneven wear
- Poor handling
- Possibility of blowouts resulting from overheated tires
- Poor sealing of the tire bead
- Wheel deformation and/or tire separation
- A greater possibility of tire damage from road hazards

 **NOTICE****■ When inspecting and adjusting tire inflation pressure**

Be sure to put the tire valve caps back on.

Without the valve caps, dirt or moisture could get into the valve and cause air leakage, which could result in an accident. If the caps are lost, replace them as soon as possible.

Wheels

If a wheel is bent, cracked or heavily corroded, it should be replaced. Otherwise, the tire may separate from the wheel or cause a loss of handling control.

Wheel selection

When replacing wheels, care should be taken to ensure that they are equivalent to those removed in load capacity, diameter, rim width and inset*.

Replacement wheels are available at any authorized Toyota dealer or repairer, or another duly qualified and equipped professional.

*: Conventionally referred to as "offset".

Toyota does not recommend using the following:

- Wheels of different sizes or types
- Used wheels
- Bent wheels that have been straightened

Aluminum wheel precautions (if equipped)

- Use only Toyota wheel nuts and wrenches designed for use with your aluminum wheels.
- When rotating, repairing or changing your tires, check that the wheel nuts are still tight after driving 1600 km (1000 miles).
- Be careful not to damage the aluminum wheels when using tire chains.
- Use only Toyota genuine balance weights or equivalent and use a plastic or rubber hammer when balancing your wheels.

■ **When removing the wheel ornament (vehicles with steel wheels and emergency tire puncture repair kit)**

Remove the wheel ornament using the wheel cap clip.

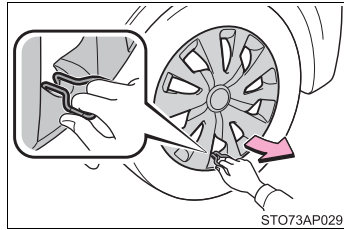

■ **When replacing wheels (vehicles with a tire pressure warning system)**

The wheels of your vehicle are equipped with tire pressure warning valves and transmitters (except for spare tire [include compact spare tire]) that allow the tire pressure warning system to provide advance warning in the event of a loss in tire inflation pressure. Whenever wheels are replaced, tire pressure warning valves and transmitters must be installed. (→P. 348)

⚠ WARNING

■ **When replacing wheels**

- Do not use wheels that are a different size from those recommended in the Owner's Manual, as this may result in a loss of handling control.
- Never use an inner tube in a leaking wheel which is designed for a tubeless tire. Doing so may result in an accident, causing death or serious injury.

■ **When installing the wheel nuts**

- Be sure to install the wheel nuts with the tapered ends facing inward. Installing the nuts with the tapered ends facing outward can cause the wheel to break and eventually cause the wheel to come off while driving, which could lead to an accident resulting in death or serious injury.

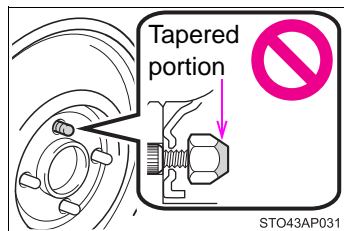

 **WARNING**

- Never use oil or grease on the wheel bolts or wheel nuts.
Oil and grease may cause the wheel nuts to be excessively tightened, leading to bolt or disc wheel damage. In addition, the oil or grease can cause the wheel nuts to loosen and the wheel may fall off, causing an accident and resulting in death or serious injury. Remove any oil or grease from the wheel bolts or wheel nuts.

■ **Use of defective wheels prohibited**

Do not use cracked or deformed wheels.

Doing so could cause the tire to leak air during driving, possibly causing an accident.

 **NOTICE**

■ **Replacing tire pressure warning valves and transmitters (vehicles with a tire pressure warning system)**

- Because tire repair or replacement may affect the tire pressure warning valves and transmitters, make sure to have tires serviced by any authorized Toyota dealer or repairer, or another duly qualified and equipped professional or other qualified service shop. In addition, make sure to purchase your tire pressure warning valves and transmitters at any authorized Toyota dealer or repairer, or another duly qualified and equipped professional.
- Ensure that only genuine Toyota wheels are used on your vehicle.
Tire pressure warning valves and transmitters may not work properly with non-genuine wheels.

Air conditioning filter

The air conditioning filter must be changed regularly to maintain air conditioning efficiency.

Removal method

- 1 Turn the engine switch to the "LOCK" position (vehicles without a smart entry & start system) or off (vehicles with a smart entry & start system).
- 2 Open the glove box and slide off the damper.

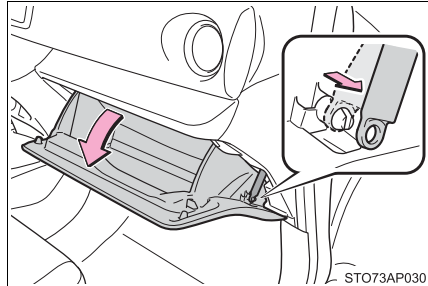

- 3 Push in each side of the glove box to disconnect the upper claws.

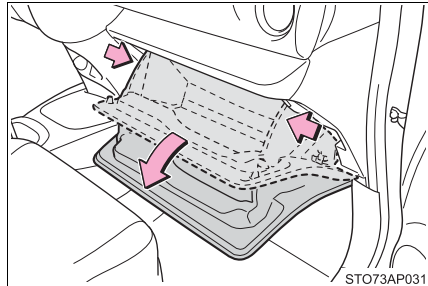

- 4 Pull out the glove box and disconnect the lower claws.

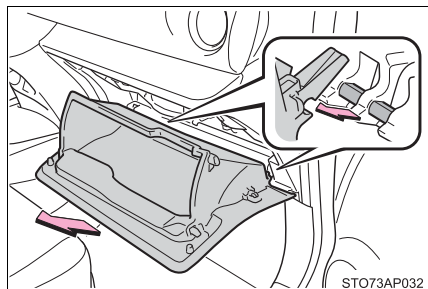

5 Remove the filter cover.

▶ Left-hand drive vehicles

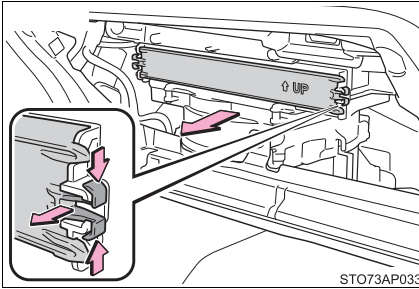

▶ Right-hand drive vehicles

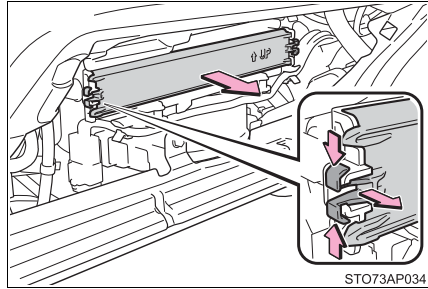

6 Remove the air conditioning filter and replace it with a new one.

The “↑UP” marks shown on the filter should be pointing up.

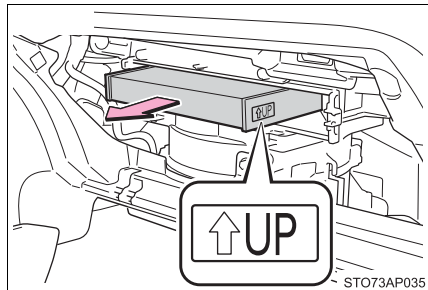

■ **Checking interval**

Inspect and replace the air conditioning filter according to the maintenance schedule. In dusty areas or areas with heavy traffic flow, early replacement may be required. (For scheduled maintenance information, please refer to the “Toyota Service Booklet” or “Toyota Warranty Booklet”.)

■ **If air flow from the vents decreases dramatically**

The filter may be clogged. Check the filter and replace if necessary.

 **NOTICE**

■ **When using the air conditioning system**

Make sure that a filter is always installed.

Using the air conditioning system without a filter may cause damage to the system.

Wireless remote control/electronic key battery*

Replace the battery with a new one if it is depleted.

You will need the following items:

- Flathead screwdriver
- Lithium battery CR2016 (vehicles without a smart entry & start system), or CR2032 (vehicles with a smart entry & start system)

Replacing the battery

► Vehicles without a smart entry & start system

1 Lift the cover.

Insert the screw driver in the slot and push down.

To prevent damage to the key, cover the tip of the screwdriver with a tape.

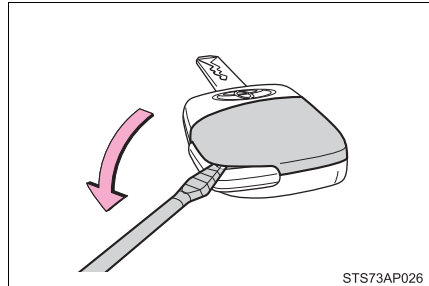

2 Remove the cover.

Insert the screw driver in the bottom of the key and push down.

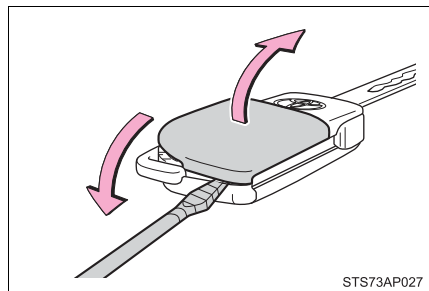

*: If equipped

3 Remove the depleted battery.

Insert a new battery with the “+” terminal facing up.

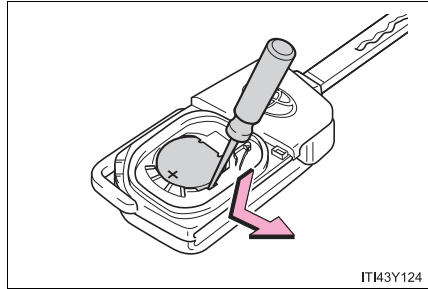

IT443Y124

► Vehicles with a smart entry & start system

1 Take out the mechanical key.

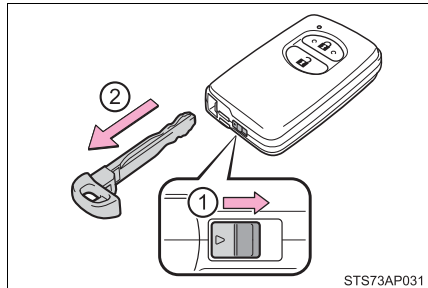

STS73AP031

2 Remove the cover.

To prevent damage to the key, cover the tip of the screwdriver with a tape.

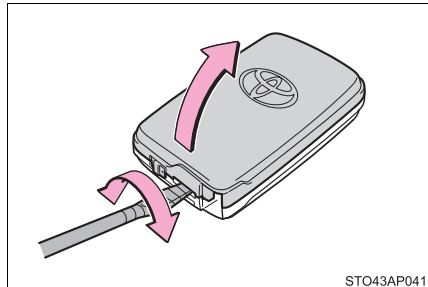

STO43AP041

3 Remove the depleted battery.

Insert a new battery with the “+” terminal facing up.

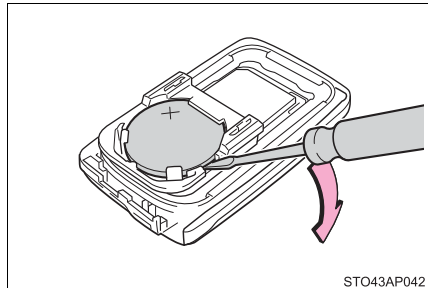

STO43AP042

■ **Use a CR2016 (vehicles without a smart entry & start system) or CR2032 (vehicles with a smart entry & start system) lithium battery**

- Batteries can be purchased at any authorized Toyota dealer or repairer, or another duly qualified and equipped professional, local electrical appliance shops or camera stores.
- Replace only with the same or equivalent type recommended by the manufacturer.
- Dispose of used batteries according to local laws.

■ **If the key battery is depleted**

The following symptoms may occur:

- The smart entry & start system (if equipped) and wireless remote control will not function properly.
- The operational range will be reduced.

 **WARNING**

■ **Removed battery and other parts**

These parts are small and if swallowed by a child, they can cause choking. Keep away from children. Failure to do so could result in death or serious injury.

■ **Certification for the lithium battery**

RISK OF EXPLOSION IF BATTERY IS REPLACED BY AN INCORRECT TYPE. DISPOSE OF USED BATTERIES ACCORDING TO THE INSTRUCTIONS

 **NOTICE**

■ **For normal operation after replacing the battery**

Observe the following precautions to prevent accidents:

- Always work with dry hands.
Moisture may cause the battery to rust.
- Do not touch or move any other component inside the remote control.
- Do not bend either of the battery terminals.

Checking and replacing fuses

If any of the electrical components do not operate, a fuse may have blown. If this happens, check and replace the fuses as necessary.

- 1 Turn the engine switch to the “LOCK” position (vehicles without a smart entry & start system) or off (vehicles with a smart entry & start system).
- 2 Open the fuse box cover.
 - ▶ Engine compartment: type A and B fuse boxes

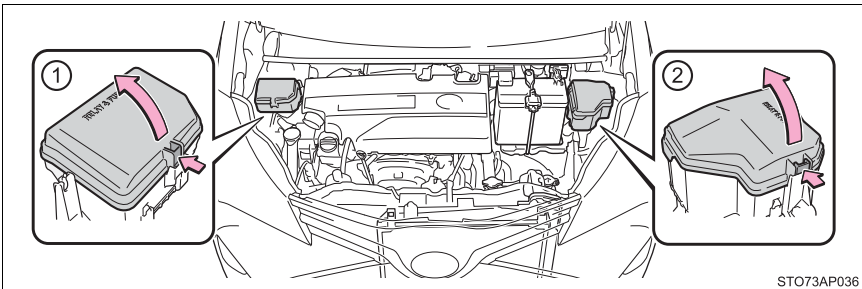

- ① Type A fuse box
Push the tab in and lift the lid off.
- ② Type B fuse box
Push the tab in and lift the lid off.

► Engine compartment: type C fuse box (left-hand drive vehicles)

- ① Pull the rubber strip on the edge to unhook it from the cover, and then push the tabs in and lift the cover off.

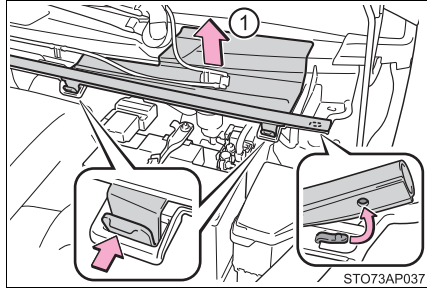

- ② Remove the battery terminal cover and then the fuse box cover.

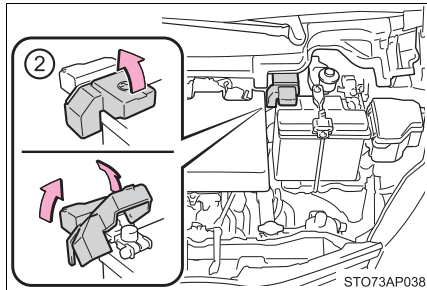

► Engine compartment: type C fuse box (right-hand drive vehicles)

- ① Pull the rubber strip on the edge to unhook it from the cover, and then push the tabs in and lift the cover off.

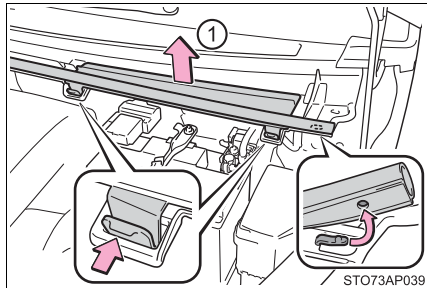

- ② Remove the battery terminal cover and then the fuse box cover.

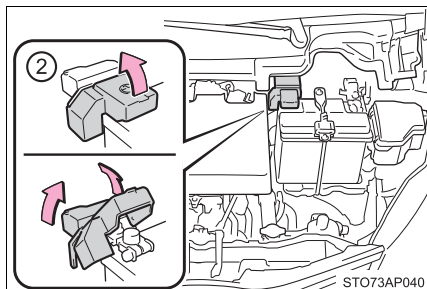

► Instrument panel (left-hand drive vehicles)

Remove the lid.

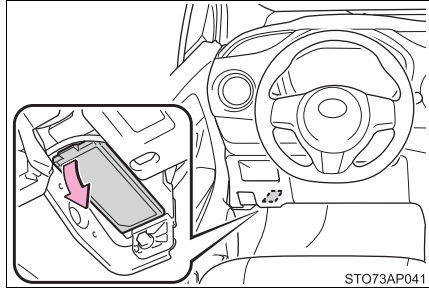

► Instrument panel (right-hand drive vehicles)

① Remove the cover.

Do not pull off the cover using excessive force as it is attached to the footwell light.

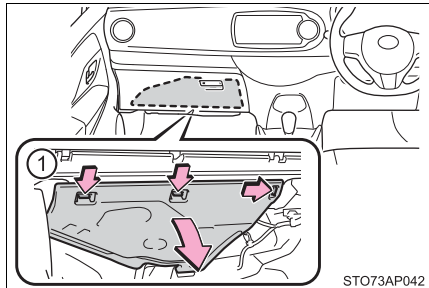

② Remove the lid.

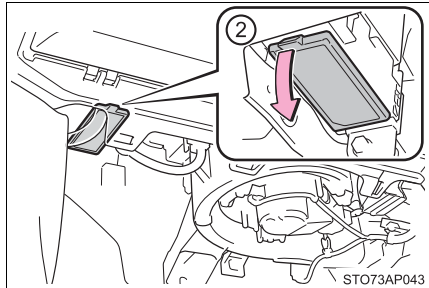

③ Remove the fuse with the pull-out tool.

Only type A fuse can be removed using the pullout tool.

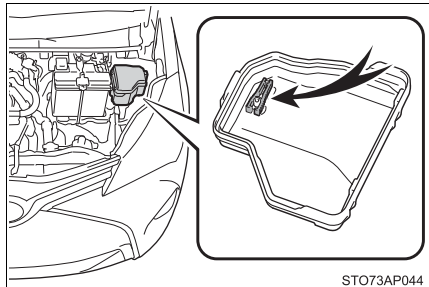

4 Check if the fuse is blown.

- ① Normal fuse
- ② Blown fuse

From Type A to F:

Replace the blown fuse with a new fuse of an appropriate amperage rating. The amperage rating can be found on the fuse box lid.

Type G:

Contact any authorized Toyota dealer or repairer, or another duly qualified and equipped professional.

► Type A

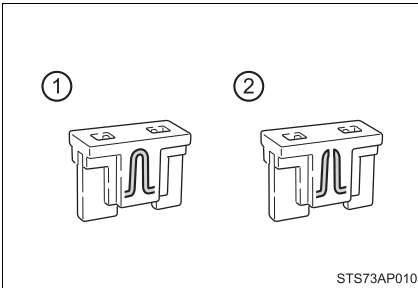

► Type B

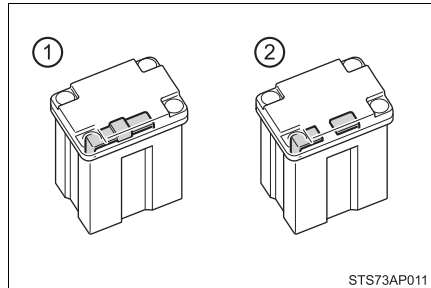

► Type C

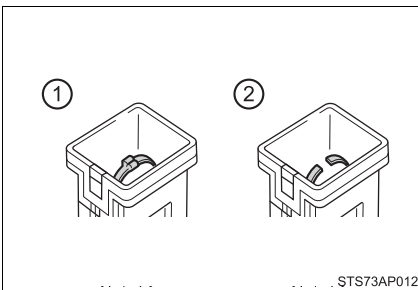

► Type D

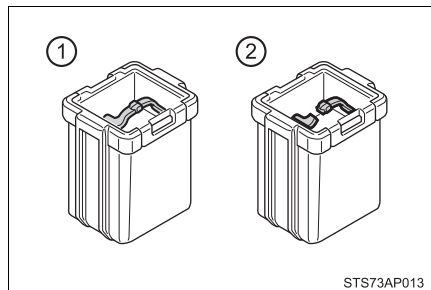

▶ Type E

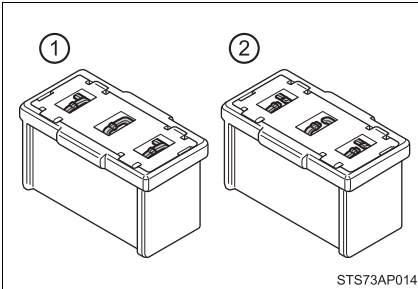

▶ Type F

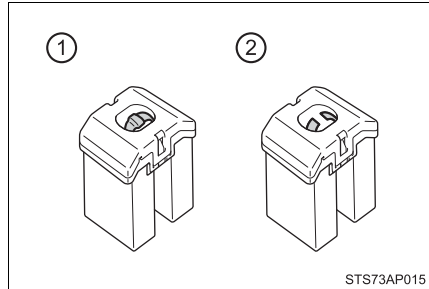

▶ Type G

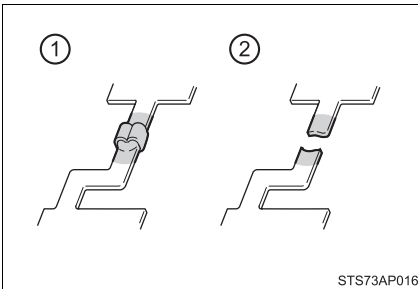

■ After a fuse is replaced

- If the lights do not turn on even after the fuse has been replaced, a bulb may need replacement. (→P. 376)
- If the replaced fuse blows again, have the vehicle inspected by any authorized Toyota dealer or repairer, or another duly qualified and equipped professional.

■ If there is an overload in a circuit

The fuses are designed to blow, protecting the wiring harness from damage.

■ When replacing light bulbs

Toyota recommends that you use genuine Toyota products designed for this vehicle. Because certain bulbs are connected to circuits designed to prevent overload, non-genuine parts or parts not designed for this vehicle may be unusable.

■ When reinstalling the cover (type C fuse box)

▶ Left-hand drive vehicles

Reinstall the cover, and then hook the rubber strip's groove onto the cover.

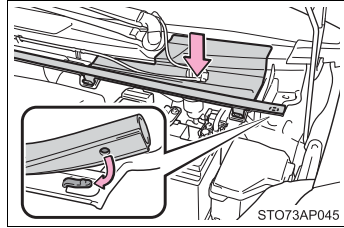

▶ Right-hand drive vehicles

Reinstall the cover, and then hook the rubber strip's groove onto the cover.

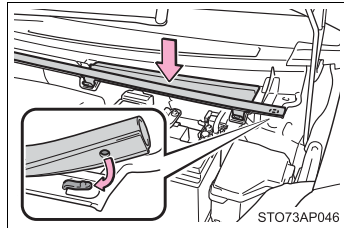

⚠ WARNING

■ To prevent system breakdowns and vehicle fire

Observe the following precautions.

Failure to do so may cause damage to the vehicle, and possibly a fire or injury.

- Never use a fuse of a higher amperage rating than that indicated, or use any other object in place of a fuse.
- Always use a genuine Toyota fuse or equivalent.
Never replace a fuse with a wire, even as a temporary fix.
- Do not modify the fuses or fuse boxes.

⚠ NOTICE

■ Before replacing fuses

Have the cause of electrical overload determined and repaired by any authorized Toyota dealer or repairer, or another duly qualified and equipped professional as soon as possible.

Light bulbs

You may replace the following bulbs by yourself. The difficulty level of replacement varies depending on the bulb. As there is a danger that components may be damaged, we recommend that replacement is carried out by any authorized Toyota dealer or repairer, or another duly qualified and equipped professional.

For more information about replacing other light bulbs, contact any authorized Toyota dealer or repairer, or another duly qualified and equipped professional.

Preparing for light bulb replacement

Check the wattage of the light bulb to be replaced. (→P. 486)

Bulb locations

■ Front

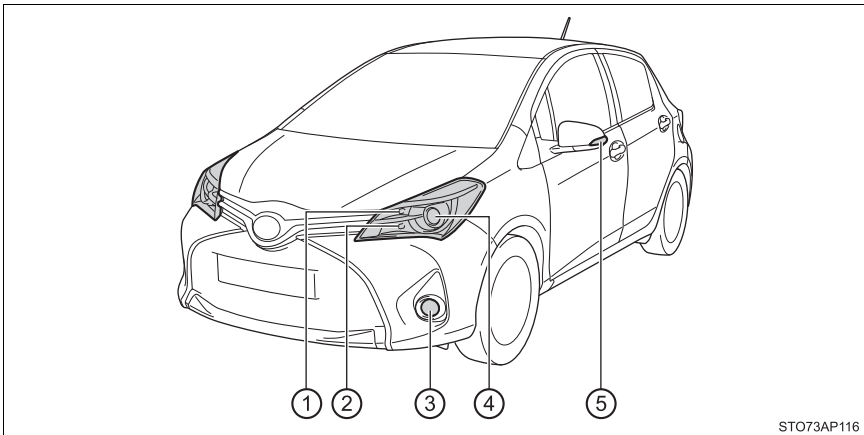

- | | |
|--|----------------------------------|
| ① Front position lights/daytime running lights (bulb type) | ③ Front fog lights (if equipped) |
| ② Front turn signal lights | ④ Halogen headlights |
| | ⑤ Side turn signal lights |

■ Rear

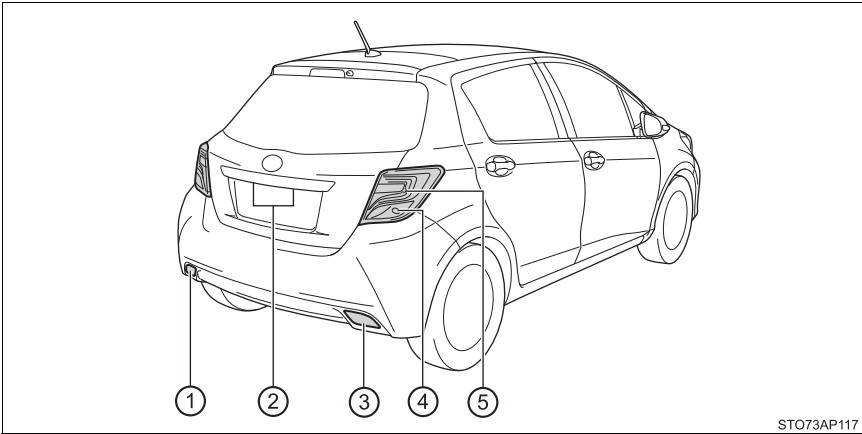

- ① Rear fog light*¹/
back-up light*²
- ② License plate lights
- ③ Back-up light*¹/
rear fog light*²
- ④ Rear turn signal lights
- ⑤ Stop/tail lights (bulb type)

*1: Left-hand drive vehicles

*2: Right-hand drive vehicles

Replacing light bulbs

■ Halogen headlights

► Reflector type

1 Unplug the connector.

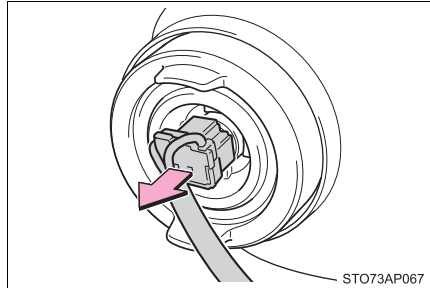

2 Remove the rubber cover.

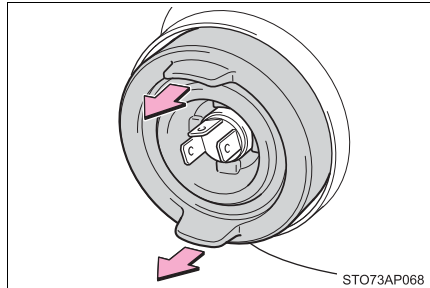

3 Release the bulb retaining spring.

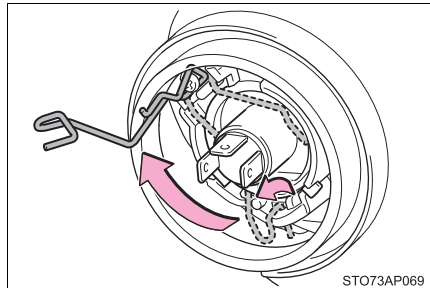

4 Remove the bulb.

To install a new bulb, align tabs of the bulb with the cutouts of the mounting hole.

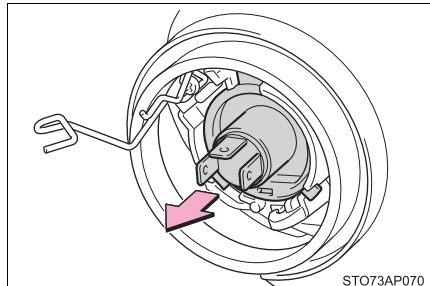

5 Set the new light bulb.

Align the 3 tabs on the light bulb with the mounting and insert.

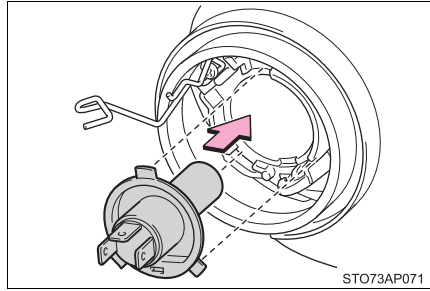
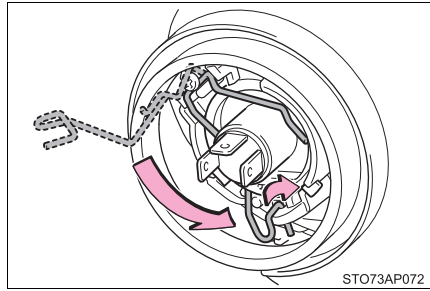
**6** Install the bulb retaining spring.**7** Install the rubber cover.

Ensure the rubber cover is securely attached.

- ① Fit the rubber cover outer circumference in firmly.
- ② Fit the rubber cover around the light bulb in until the light bulb plug can be seen.

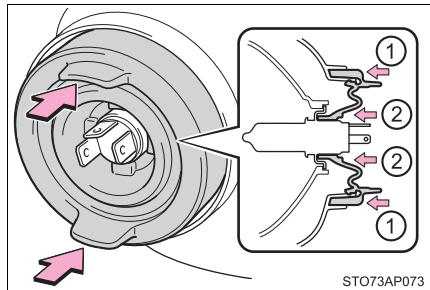
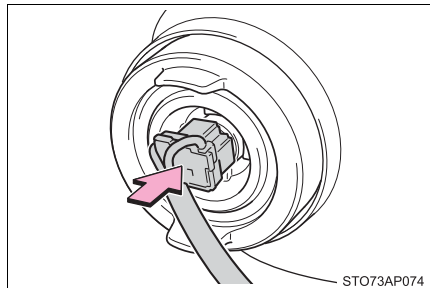
**8** Install the connector.

► Projector type

- 1 Turn the bulb base counter-clockwise.

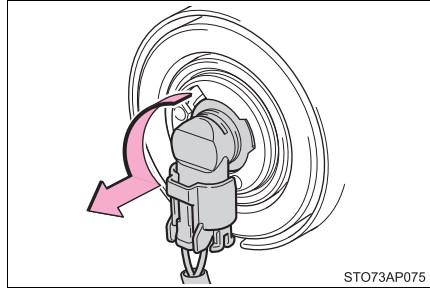

- 2 Pull the bulb out while pressing the lock release of the connector.

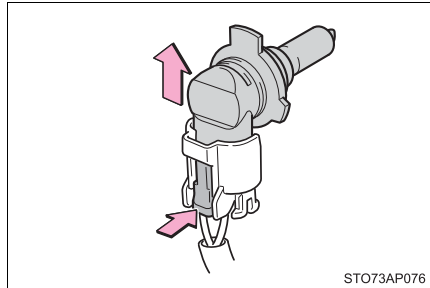

- 3 Replace the light bulb, and install the bulb base.
Align the 3 tabs on the light bulb with the mounting and insert.

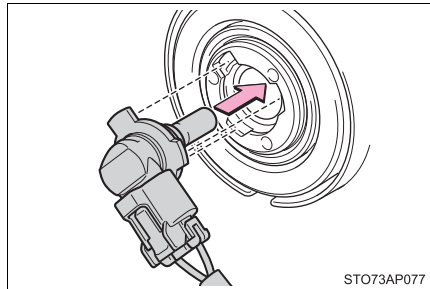

- 4 Turn and secure the bulb base.

Shake the bulb base gently to check that it is not loose, turn the headlights on once and visually confirm that no light is leaking through the mounting.

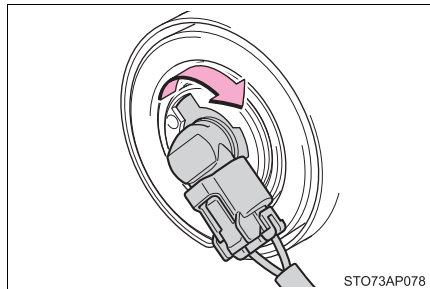

■ Front fog lights (if equipped)

- 1 Turn the steering wheel in the opposite direction of the light to be replaced.

Turn the steering wheel to a point that allows your hand to easily fit between the tire and fender liner.

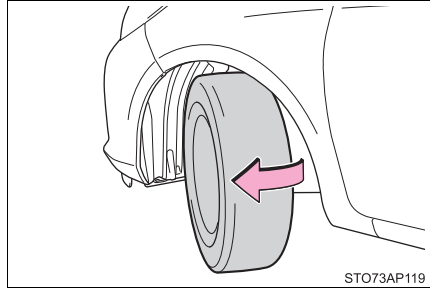

- 2 Remove the screw.

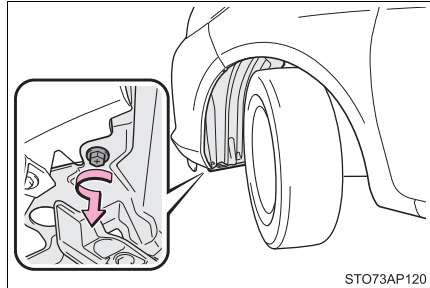

- 3 Partly remove the fender liner until the bulb is visible.

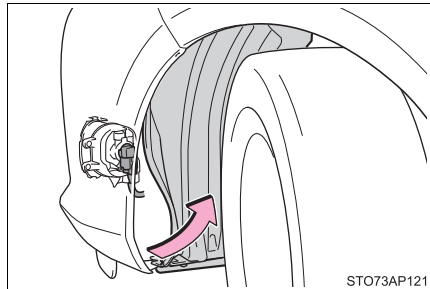

- 4 Unplug the connector while pressing the lock release.

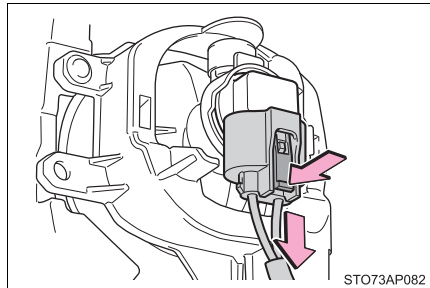

- 5 Turn the bulb base counter-clockwise.

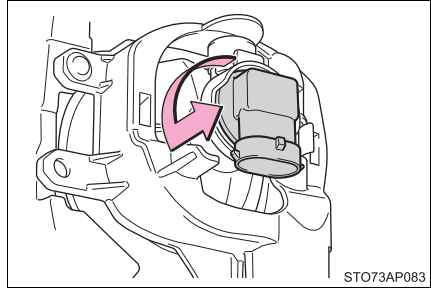

- 6 Set the new light bulb.
Align the 3 tabs on the light bulb with the mounting, and insert.

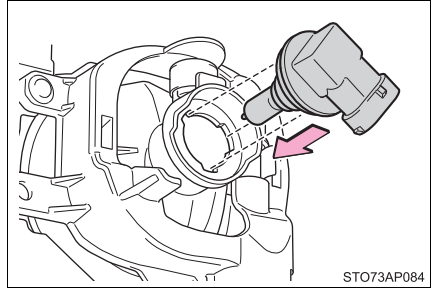

- 7 Turn and secure the bulb.

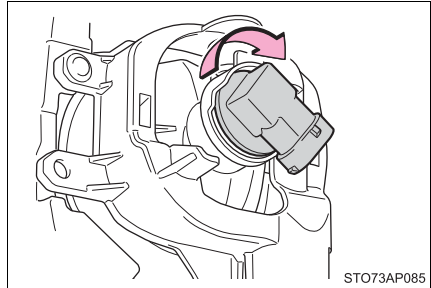

- 8 Install the connector.

Shake the bulb base gently to check that it is not loose, turn the front fog light, on once and visually confirm that no light is leaking through the mounting.

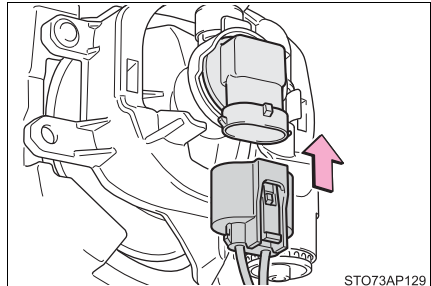

9 Reinstall the fender liner.

Attach the end of the fender liner to the inside of the front bumper.

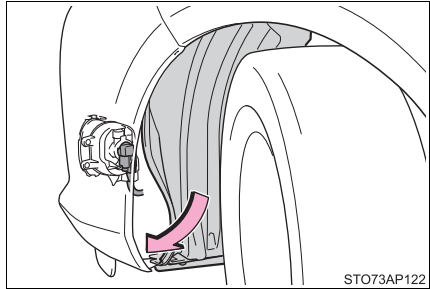
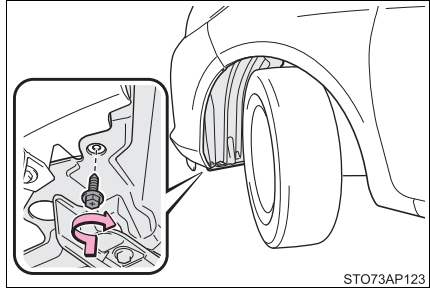
**10** Install the screw.

■ **Front position lights/daytime running lights (bulb type)**

1 Turn the bulb base counterclockwise.

▶ Type A

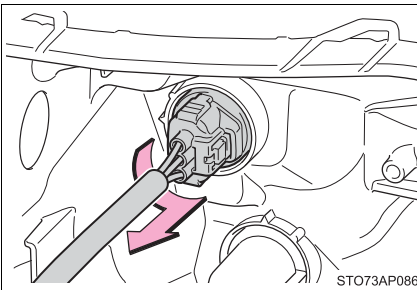

▶ Type B

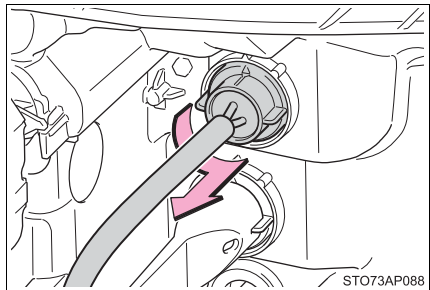

2 Remove the light bulb.

▶ Type A

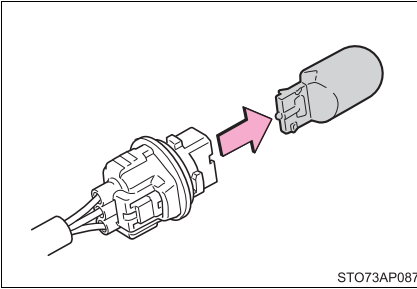

▶ Type B

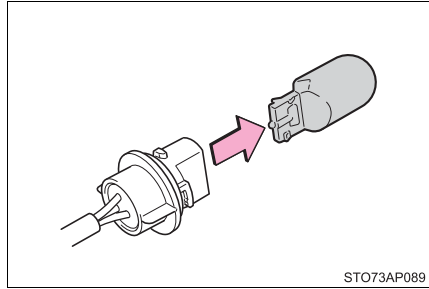

3 When installing, reverse the steps listed.

■ **Front turn signal lights**

1 Turn the bulb base counterclockwise.

▶ Type A

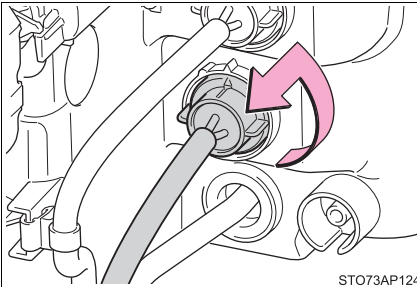

▶ Type B

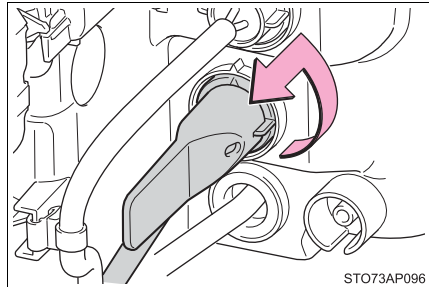

2 Remove the light bulb

▶ Type A

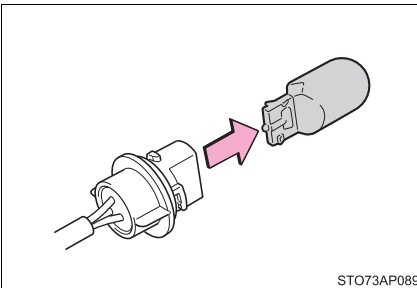

▶ Type B

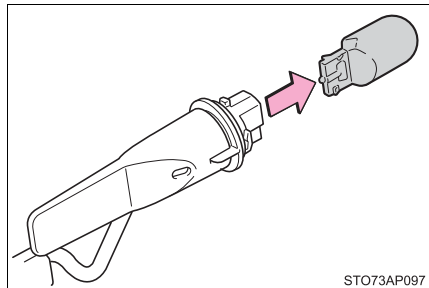

3 When installing, reverse the steps listed.

■ Side turn signal lights

- 1 Depress the mirror.

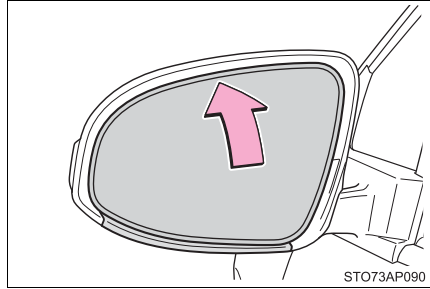

- 2 Remove the mirror.

To prevent damaging the vehicle, wrap the screwdriver with a tape.

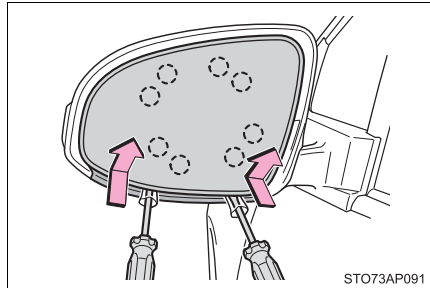

- 3 Remove the bulb base.

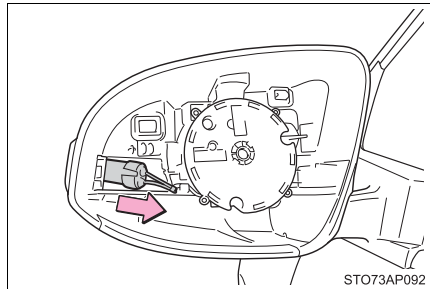

- 4 Remove the light bulb.

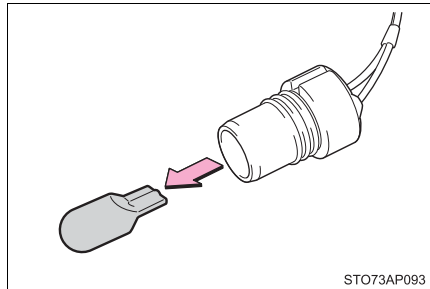

- 5 After installing the new bulb, secure the bulb base to the mirror body.

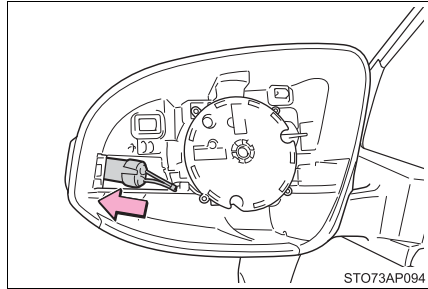

- 6 Align the tabs, and secure the mirror by pushing in each diagonally-opposite pair of tabs in order.

Make sure to insert the tabs in order as shown in the illustration, and push them in until a click is heard.

If you do not hear the click, do not force the tabs in. Instead, remove the mirror and check that the tabs are aligned.

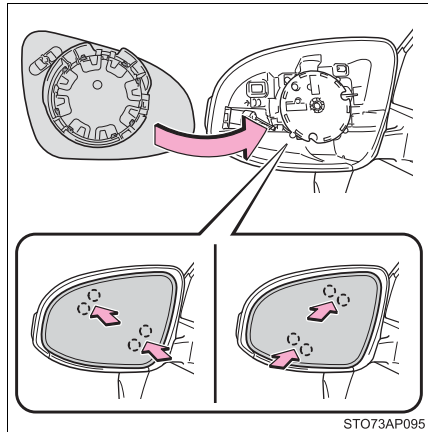

■ Stop/tail lights (bulb type), and rear turn signal lights

- 1 Open the back door and remove the cover.

To prevent damaging the vehicle, wrap the screwdriver with a tape.

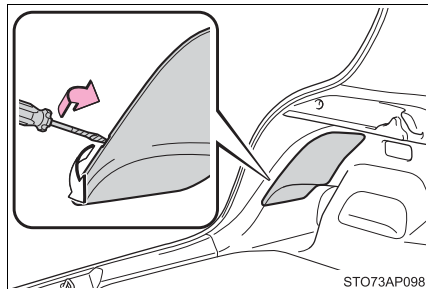

- 2 Turn the bulb base counter-clockwise.

- ① Stop/tail light
- ② Rear turn signal light

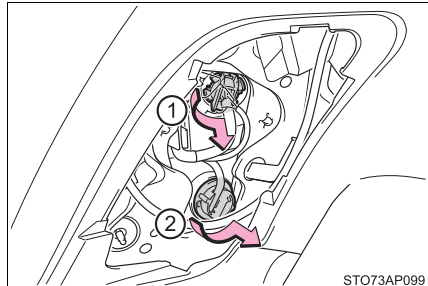

3 Remove the light bulb.

- ① Stop/tail light
- ② Rear turn signal light

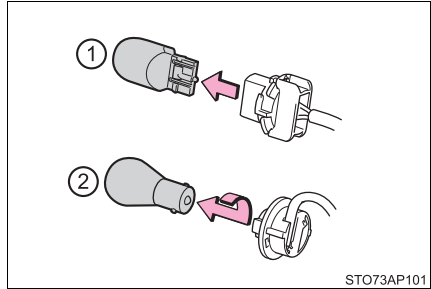
**4** Install the new bulb.

- ① Stop/tail light
- ② Rear turn signal light

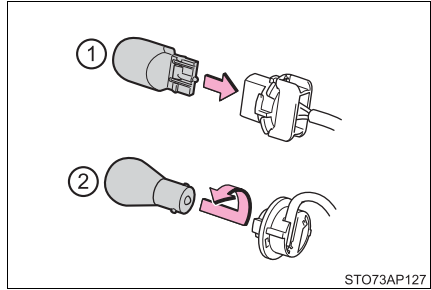
**5** Turn and secure the bulb base.

- ① Stop/tail light
- ② Rear turn signal light

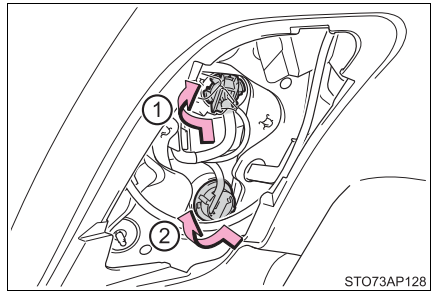
**6** Install the cover.

- ① Align the cover claws with the notches.
- ② Press the cover until it is fixed.

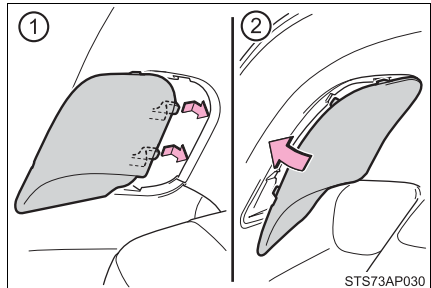

■ License plate light

- 1 Remove the cover.

Insert a properly sized screwdriver into the hole of the cover, and pry off the cover as shown in the illustration.

To prevent damaging the vehicle, wrap the screwdriver with a tape.

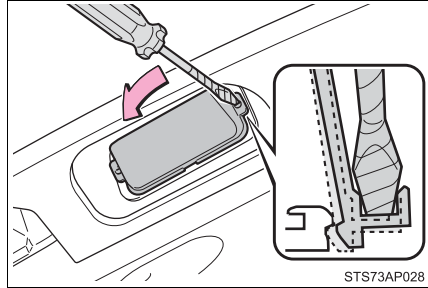

- 2 Remove the light bulb.

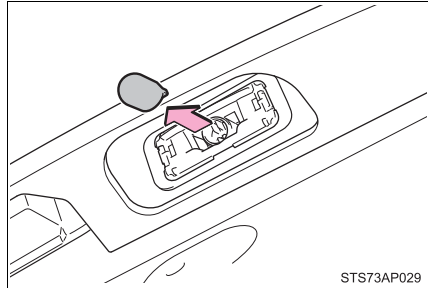

- 3 Install the new bulb.

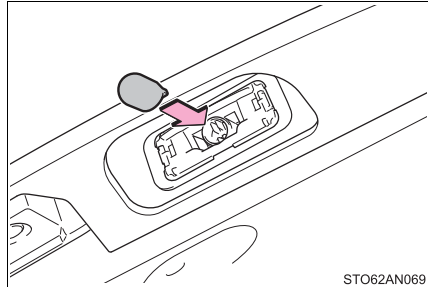

- 4 Install the cover.

Insert a properly sized screwdriver into one of the holes, push the screwdriver until clicking sound is heard. Repeat for the other hole.

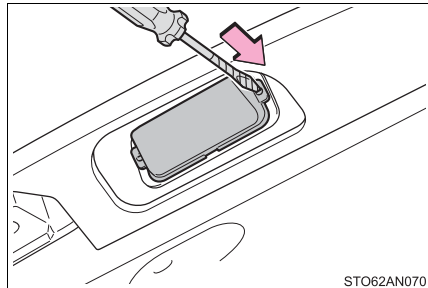

- 5 Make sure that the cover is secured by pressing on the entire cover.

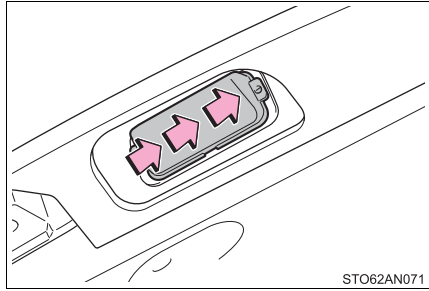

■ Back-up light/rear fog light

- 1 Remove the clip and partly remove the cover.
Pull the center section of the clip and the remove and pull out the lock.

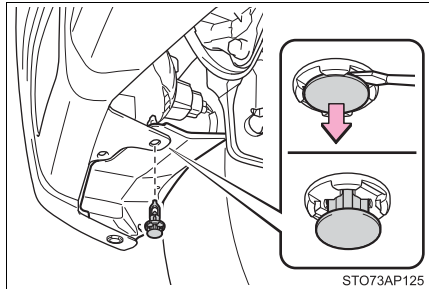

- 2 Turn the bulb base counter-clockwise.

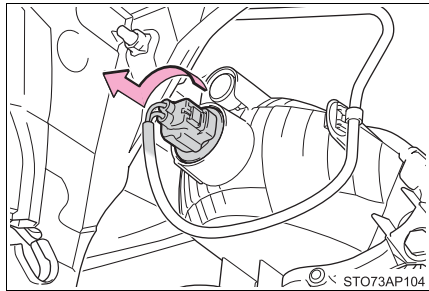

- 3 Remove the light bulb.

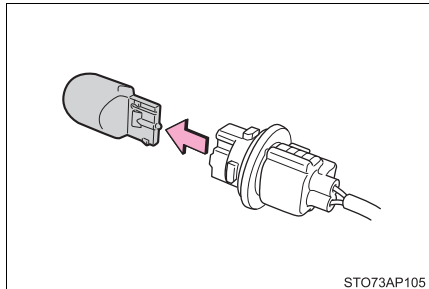

- 4 After installing the new bulb, reinstall the clip.

When installing the clip, insert the clip in and push the center of the clip.

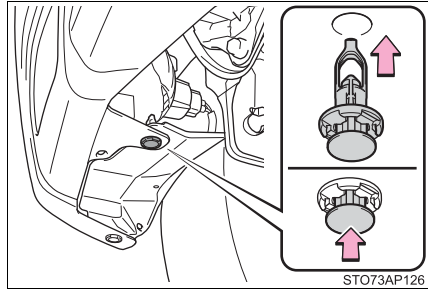

■ Replacing the following bulbs

If any of the lights listed below has burnt out, have it replaced by any authorized Toyota dealer or repairer, or another duly qualified and equipped professional.

- Front position lights and daytime running lights (LED type)
- Stop/tail lights (LED type)
- High mounted stoplight

■ LED Lights

The front position lights and daytime running lights (LED type), stop/tail lights (LED type) and high mounted stoplight consists of a number of LEDs. If any of the LEDs burn out, take your vehicle to any authorized Toyota dealer or repairer, or another duly qualified and equipped professional to have the light replaced.

If one or more LEDs in a stop light burn out, your vehicle may not conform to local laws (ECE).

■ Condensation build-up on the inside of the lens

Temporary condensation build-up on the inside of the headlight lens does not indicate a malfunction. Contact any authorized Toyota dealer or repairer, or another duly qualified and equipped professional for more information in the following situations:

- Large drops of water have built up on the inside of the lens.
- Water has built up inside the headlight.

■ When replacing light bulbs

→P. 374

 **WARNING****■ Replacing light bulbs**

- Turn off the lights. Do not attempt to replace the bulb immediately after turning off the lights.
The bulbs become very hot and may cause burns.
- Do not touch the glass portion of the light bulb with bare hands. When it is unavoidable to hold the glass portion, use and hold with a clean dry cloth to avoid getting moisture and oils on the bulb.
Also, if the bulb is scratched or dropped, it may blow out or crack.
- Fully install light bulbs and any parts used to secure them. Failure to do so may result in heat damage, fire, or water entering the headlight unit. This may damage the headlights or cause condensation to build up on the lens.

■ To prevent damage or fire

- Make sure bulbs are fully seated and locked.
- Check the wattage of the bulb before installing to prevent heat damage.

When trouble arises

8

8-1. Essential information

Emergency flashers.....394

If your vehicle has to
be stopped in
an emergency.....395

8-2. Steps to take in an emergency

If your vehicle needs to
be towed397

If you think something is
wrong.....403

Fuel pump shut off system
(gasoline engine only)404

If a warning light turns on
or a warning buzzer
sounds.....405

If you have a flat tire
(vehicles with
a spare tire)418

If you have a flat tire
(vehicles with
an emergency tire
puncture repair kit).....433

If the engine will not start...448

If the shift lever cannot be
shifted from P (vehicles
with a Multidrive).....450

If the electronic key does
not operate properly
(vehicles with a smart
entry & start system).....451

If the vehicle battery is
discharged453

If your vehicle overheats....458

If you run out of fuel and
the engine stalls
(diesel engine only)462

If the vehicle becomes
stuck464

Emergency flashers

The emergency flashers are used to warn other drivers when the vehicle has to be stopped in the road due to a breakdown, etc.

Press the switch.

All the turn signal lights will flash.
To turn them off, press the switch once again.

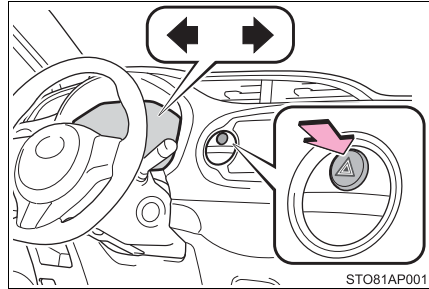

■ Emergency flashers

If the emergency flashers are used for a long time while the engine is not operating, the battery may discharge.

If your vehicle has to be stopped in an emergency

Only in an emergency, such as if it becomes impossible to stop the vehicle in the normal way, stop the vehicle using the following procedure:

- 1 Steadily step on the brake pedal with both feet and firmly depress it.
Do not pump the brake pedal repeatedly as this will increase the effort required to slow the vehicle.
- 2 Shift the shift lever to N.
 - ▶ If the shift lever is shifted to N
- 3 After slowing down, stop the vehicle in a safe place by the road.
- 4 Stop the engine.
 - ▶ If the shift lever cannot be shifted to N
- 3 Keep depressing the brake pedal with both feet to reduce vehicle speed as much as possible.
- 4 Vehicles without a smart entry & start system: Stop the engine by turning the engine switch to the "ACC" position.

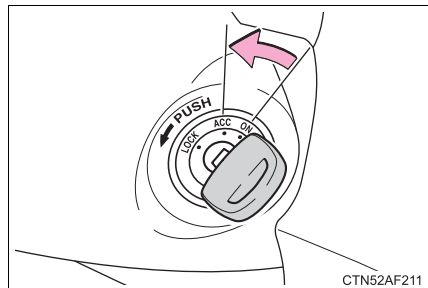

- 4 Vehicles with a smart entry & start system: To stop the engine, press and hold the engine switch for 3 consecutive seconds or more, or press it briefly 3 times or more in succession.

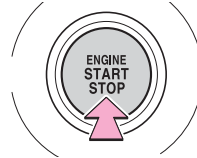

Press and hold for 3 seconds or more, or press briefly 3 times or more

CTY52AD212

- 5 Stop the vehicle in a safe place by the road.

 **WARNING**

■ **If the engine has to be turned off while driving**

- Power assist for the brakes and steering wheel will be lost, making the brake pedal harder to depress and the steering wheel heavier to turn. Decelerate as much as possible before turning off the engine.
- Vehicles without a smart entry & start system: Never attempt to remove the key, as doing so will lock the steering wheel.

If your vehicle needs to be towed

If towing is necessary, we recommend having your vehicle towed by any authorized Toyota dealer or repairer, or another duly qualified and equipped professional such as a commercial towing service, using a lift-type truck or flatbed truck.

Use a safety chain system for all towing, and abide by all state/provincial and local laws.

If towing your vehicle with a wheel-lift type truck from the front, the vehicle's rear wheels and axles must be in good conditions. (→P. 398, 401)

If they are damaged, use a towing dolly or flatbed truck.

Situations needs to contact dealers before towing

The following may indicate a problem with your transmission. Contact any authorized Toyota dealer or repairer, or another duly qualified and equipped professional before towing.

- The engine is running but the vehicle will not move.
- The vehicle makes an abnormal sound.

Towing with a sling-type truck

Do not tow with a sling-type truck to prevent body damage.

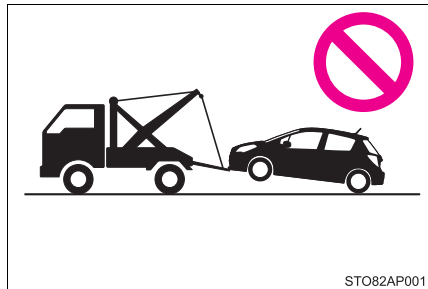

Towing with a wheel-lift type truck

► From the front

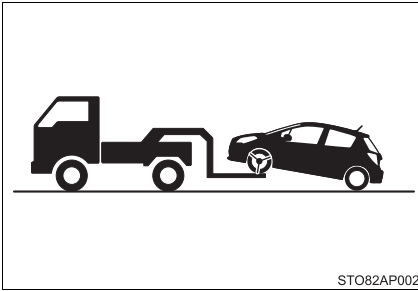

Release the parking brake.

► From the rear

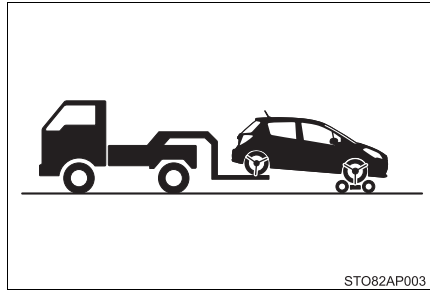

Use a towing dolly under the front wheels.

Using a flatbed truck

If your Toyota is transported by a flatbed truck, it should be tied down at the locations shown in the illustration.

After transporting, return the covers that were attached to the rear side.

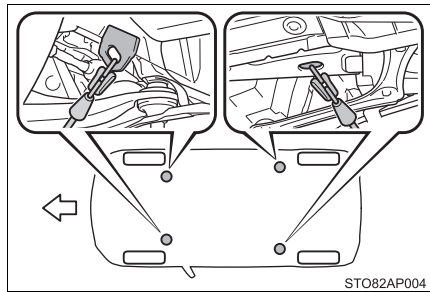

If you use chains or cables to tie down your vehicle, the angles shaded in black must be 45°.

Do not overly tighten the tie downs or the vehicle may be damaged.

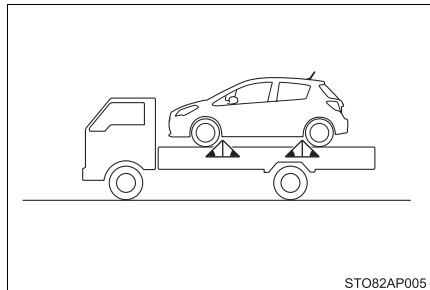

Emergency towing

If a tow truck is not available in an emergency, your vehicle may be temporarily towed using a cable or chain secured to the emergency towing eyelet. This should only be attempted on hard surfaced roads for 80 km (50 miles) at low speeds.

A driver must be in the vehicle to steer and operate the brakes. The vehicle's wheels, drive train, axles, steering and brakes must be in good condition.

Emergency towing procedure

- 1 Take out the towing eyelet. (→P. 419)
- 2 Remove the eyelet cover by turning.

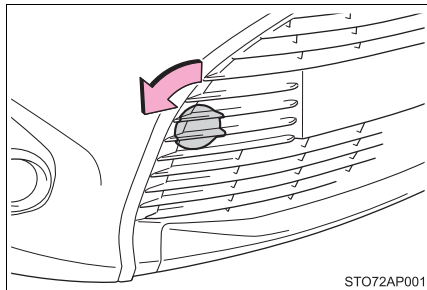

- 3 Insert the towing eyelet into the hole and tighten partially by hand.

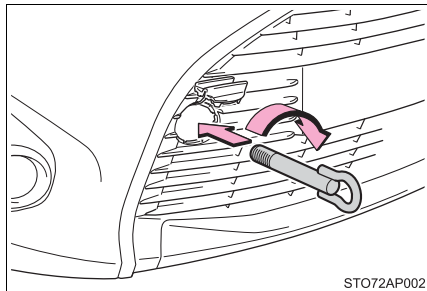

- 4 Tighten down the towing eyelet securely using a wheel nut wrench* or hard metal bar.

*: If a wheel nut wrench is not equipped, a wheel nut wrench can be purchased at any authorized Toyota dealer or repairer, or another duly qualified and equipped professional.

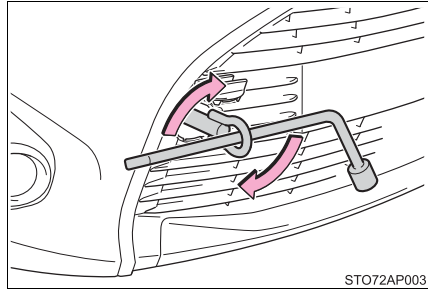

- 5 Securely attach a cable or chain to the towing eyelet.

Take care not to damage the vehicle body.

- 6 Vehicles without a smart entry & start system: Enter the vehicle being towed and start the engine.

If the engine does not start, turn the engine switch to the "ON" position.

Vehicles with a smart entry & start system: Enter the vehicle being towed and start the engine.

If the engine does not start, turn the engine switch to IGNITION ON mode.

- 7 Shift the shift lever to N and release the parking brake.

When the shift lever cannot be shifted: →P. 450

■ While towing

If the engine is not running, the power assist for the brakes and steering will not function, making steering and braking more difficult.

■ Wheel nut wrench

- Vehicles with a wheel nut wrench: Wheel nut wrench is installed in the luggage. (→P. 419, 434)
- Vehicles without a wheel nut wrench: Wheel nut wrench can be purchased at any authorized Toyota dealer or repairer, or another duly qualified and equipped professional.

⚠ WARNING

Observe the following precautions.
Failure to do so may result in death or serious injury.

■ **When towing the vehicle**

Be sure to transport the vehicle with the front wheels raised or with all four wheels raised off the ground. If the vehicle is towed with the front wheels contacting the ground, the drivetrain and related parts may be damaged.

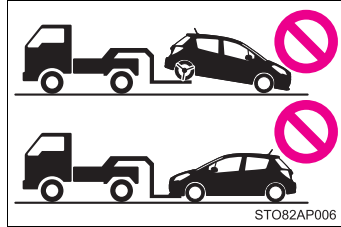

■ **While towing**

- When towing using a rope, avoid sudden starts, etc. which place excessive stress on the towing hook and rope.
The towing hook or rope may become damaged, broken debris may hit people and cause serious damage.
- Vehicles without a smart entry & start system: Do not turn the engine switch to the "LOCK" position.
There is a possibility that the steering wheel is locked and can not be operated.
- Vehicles with a smart entry & start system: Do not turn the engine switch off.
There is a possibility that the steering wheel is locked and can not be operated.

■ **Installing towing eyelet to the vehicle**

Make sure that towing eyelet is installed securely.
If not securely installed, towing eyelet may come loose during towing.

**NOTICE****■ To prevent damage to the vehicle when towing using a wheel-lift type truck**

When raising the vehicle, ensure adequate ground clearance for towing at the opposite end of the raised vehicle. Without adequate clearance, the vehicle could be damaged while being towed.

■ To prevent body damage when towing with a sling-type truck

Do not tow with a sling-type truck, either from the front or rear.

If you think something is wrong

If you notice any of the following symptoms, your vehicle probably needs adjustment or repair. Contact any authorized Toyota dealer or repairer, or another duly qualified and equipped professional as soon as possible.

Visible symptoms

- Fluid leaks under the vehicle
(Water dripping from the air conditioning after use is normal)
- Flat-looking tires or uneven tire wear
- High engine coolant temperature warning light flashes or comes on
- Low engine coolant temperature indicator comes on or does not come on continuously

Audible symptoms

- Changes in exhaust sound
- Excessive tire squeal when cornering
- Strange noises related to the suspension system
- Pinging or other noises related to the engine

Operational symptoms

- Engine misfire, stumbling or running roughly
- Appreciable loss of power
- Vehicle pulls heavily to one side when braking
- Vehicle pulls heavily to one side when driving on a level road
- Loss of brake effectiveness, spongy feeling, pedal almost touches the floor

Fuel pump shut off system (gasoline engine only)

To minimize the risk of fuel leakage when the engine stalls or when an airbag inflates upon collision, the fuel pump shut off system stops the supply of fuel to the engine.

Follow the procedure below to restart the engine after the system is activated.

▶ Vehicles without a smart entry & start system

- 1 Turn the engine switch to the “ACC” or “LOCK” position.
- 2 Restart the engine.

▶ Vehicles with a smart entry & start system

- 1 Turn the engine switch to ACCESSORY mode or turn it off.
- 2 Restart the engine.



NOTICE

■ Before starting the engine



Inspect the ground under the vehicle.





If you find that fuel has leaked onto the ground, the fuel system has been damaged and is in need of repair. Do not restart the engine.







If a warning light turns on or a warning buzzer sounds





Calmly perform the following actions if any of the warning lights comes on or flashes. If a light comes on or flashes, but then goes off, this does not necessarily indicate a malfunction in the system. However, if this continues to occur, have the vehicle inspected by any authorized Toyota dealer or repairer, or another duly qualified and equipped professional.



Warning light and warning buzzer list

Warning light	Warning light/Details/Actions
	<p>Brake system warning light (warning buzzer)*1</p> <ul style="list-style-type: none"> • Low brake fluid • Malfunction in the brake system <p>This light also comes on when the parking brake is not released. If the light turns off after the parking brake is fully released, the system is operating normally.</p> <p>→ Immediately stop the vehicle in a safe place and contact any authorized Toyota dealer or repairer, or another duly qualified and equipped professional. Continuing to drive the vehicle may be dangerous.</p>
	<p>Charging system warning light</p> <p>Indicates a malfunction in the vehicle's charging system.</p> <p>→ Immediately stop the vehicle in a safe place and contact any authorized Toyota dealer or repairer, or another duly qualified and equipped professional.</p>
	<p>Low engine oil pressure warning light</p> <p>Indicates that the engine oil pressure is too low.</p> <p>→ Immediately stop the vehicle in a safe place and contact any authorized Toyota dealer or repairer, or another duly qualified and equipped professional.</p>

Warning light	Warning light/Details/Actions
 <p data-bbox="150 245 300 277">(Red warning light flashes or comes on)</p>	<p data-bbox="315 153 878 180">High engine coolant temperature warning light</p> <p data-bbox="338 181 990 264">Indicates that the engine is overheating. As the coolant temperature rises, it changes from flashing to steady on.</p> <p data-bbox="315 268 418 295">→ P. 458</p>
	<p data-bbox="315 320 639 347">Malfunction indicator lamp</p> <p data-bbox="338 349 631 376">Indicates a malfunction in:</p> <ul data-bbox="338 378 960 520" style="list-style-type: none"> • The electronic engine control system; • The electronic throttle control system; • The electronic Multidrive control system (if equipped); • The emission control system; or • The DPF catalytic converter (if equipped). <p data-bbox="315 523 990 608">→ Have the vehicle inspected by any authorized Toyota dealer or repairer, or another duly qualified and equipped professional immediately.</p>
	<p data-bbox="315 632 535 659">SRS warning light</p> <p data-bbox="338 660 631 687">Indicates a malfunction in:</p> <ul data-bbox="338 689 748 743" style="list-style-type: none"> • The SRS airbag system; or • The seat belt pretensioner system. <p data-bbox="315 746 990 831">→ Have the vehicle inspected by any authorized Toyota dealer or repairer, or another duly qualified and equipped professional immediately.</p>
	<p data-bbox="315 855 535 882">ABS warning light</p> <p data-bbox="338 884 631 911">Indicates a malfunction in:</p> <ul data-bbox="338 912 639 967" style="list-style-type: none"> • The ABS; or • The brake assist system. <p data-bbox="315 970 990 1054">→ Have the vehicle inspected by any authorized Toyota dealer or repairer, or another duly qualified and equipped professional immediately.</p>
	<p data-bbox="315 1078 855 1131">Electric power steering system warning light (warning buzzer)</p> <p data-bbox="338 1134 990 1189">Indicates a malfunction in the EPS (Electric Power Steering) system.</p> <p data-bbox="315 1192 990 1276">→ Have the vehicle inspected by any authorized Toyota dealer or repairer, or another duly qualified and equipped professional immediately.</p>

Warning light	Warning light/Details/Actions
	<p>Slip indicator light (if equipped) Indicates a malfunction in:</p> <ul style="list-style-type: none"> • The VSC system; • The TRC system. <p>→ Have the vehicle inspected by any authorized Toyota dealer or repairer, or another duly qualified and equipped professional immediately.</p>
 <p>(Yellow)</p>	<p>Cruise control indicator light (if equipped) Indicates a malfunction in the cruise control system. → P. 222</p>
 <p>(Yellow)</p>	<p>Speed limiter indicator light (if equipped) Indicates a malfunction in the speed limiter system. → Have the vehicle inspected by any authorized Toyota dealer or repairer, or another duly qualified and equipped professional immediately.</p>
 <p>(Flashes)</p>	<p>Stop & Start cancel indicator light (if equipped) Indicates a malfunction in the Stop & Start system. → Have the vehicle inspected by any authorized Toyota dealer or repairer, or another duly qualified and equipped professional immediately.</p>
	<p>Fuel filter warning light (diesel engine only) Indicate that the amount of accumulated water in the fuel filter has reached the specified level. → P. 346</p>
 <p>(Flashes in yellow for 15 seconds.)</p>	<p>Smart entry & start system indicator light (if equipped) Indicates a malfunction in the smart entry & start system. → Have the vehicle inspected by any authorized Toyota dealer or repairer, or another duly qualified and equipped professional.</p>
	<p>Open door warning light (warning buzzer)*2 Indicates that one or more of the doors is not fully closed. → Check that all the side doors and back door are closed.</p>

Warning light	Warning light/Details/Actions
	<p>Low fuel level warning light Gasoline engine: Indicates that remaining fuel is about 5.8 L (1.5 gal., 1.3 Imp.gal.) or less. Diesel engine: Indicates that remaining fuel is about 6.4 L (1.7 gal., 1.4 Imp.gal.) or less. → Refuel the vehicle.</p>
	<p>Driver's and front passenger's seat belt reminder light (warning buzzer)^{*3} Warns the driver and front passenger to fasten their seat belts. → Fasten the seat belt. If the passenger's seat is occupied, the front passenger's seat belt also needs to be fastened to make the warning light (warning buzzer) turn off.</p>
 <p>(On the center panel)</p>	<p>Rear passengers' seat belt reminder lights (warning buzzer)^{*3} (if equipped) Warns the rear passengers to fasten their seat belts. → Fasten the seat belt.</p>
	<p>Tire pressure warning light (if equipped) When the light comes on: Low tire inflation pressure such as</p> <ul style="list-style-type: none"> • Natural causes (→P. 412) • Flat tire (→P. 418, 433) <p>→ Adjust the tire inflation pressure to the specified level. The light will turn off after a few minutes. In case the light does not turn off even if the tire inflation pressure is adjusted, have the system checked by any authorized Toyota dealer or repairer, or another duly qualified and equipped professional.</p>

Warning light	Warning light/Details/Actions
	<p>Low engine oil level warning light (diesel engine only) Indicates that engine oil level is low. → Check the level of engine oil, and add if necessary.</p>
	<p>DPF system warning light (diesel engine with a DPF system)</p> <ul style="list-style-type: none"> • Indicates that the DPF catalytic converter needs to be cleaned due to repeated short trips and/or low-speed driving. • Indicates that the amount of accumulated deposits in the DPF catalytic converter has reached the specified level. <p>→ To clean the DPF catalytic converter, drive the vehicle at a speed of 65 km/h (40 mph) or greater for 20 to 30 minutes as much as possible until the DPF system warning light turns off.*4</p> <p>Do not turn off the engine as much as possible until the DPF system warning light turns off.</p> <p>If it is not possible to drive the vehicle at speeds of 65 km/h (40 mph) or greater, or the DPF system warning light does not turn off even after driving for more than 30 minutes, have the vehicle inspected by any authorized Toyota dealer or repairer, or another duly qualified and equipped professional.</p>

Warning light	Warning light/Details/Actions
	<p>Engine oil change reminder light (diesel engine only)</p> <p>When the light flashes:</p> <p>Indicates that the engine oil is scheduled to be changed.</p> <ul style="list-style-type: none"> • Vehicles without a DPF system^{*5}: Flashes approximately 35000 km (22000 miles) after the engine oil is changed. (The indicator will not work properly unless the oil maintenance data has been reset). • Vehicles with a DPF system^{*5}: Flashes approximately 14500 km (9000 miles) after the engine oil is changed. (→P. 412) (The indicator will not work properly unless the oil maintenance data has been reset). <p>→ Check the engine oil, and change if necessary. After changing the engine oil, the oil change system should be reset. (→P. 338)</p> <p>When the light comes on:</p> <p>Indicates that the engine oil should be changed.</p> <ul style="list-style-type: none"> • Vehicles without a DPF system^{*5}: Comes on approximately 40000 km (25000 miles) after the engine oil is changed (and the oil maintenance data has been reset). • Vehicles with a DPF system^{*5}: Comes on approximately 15000 km (9300 miles) after the engine oil is changed (and the oil maintenance data has been reset). <p>→ Check and change the engine oil, and oil filter by any authorized Toyota dealer or repairer, or another duly qualified and equipped professional. After changing the engine oil, the oil change system should be reset. (→P. 338)</p>

*1: Parking brake engaged warning buzzer:

The buzzer sounds to indicate that the parking brake is still engaged (with the vehicle having reached a speed of 5 km/h [3 mph]).

*2: Open door warning buzzer:

A buzzer will sound if the vehicle reaches a speed of 5 km/h (3 mph) or more with any door open.

*3: Driver's and passenger's seat belt buzzer:

The driver's and passenger's seat belt buzzer sounds to alert the driver and passenger that his or her seat belt is not fastened. The buzzer sounds for 30 seconds after the vehicle reaches a speed of at least 20 km/h (12 mph). Then, if the seat belt is still unfastened, the buzzer will sound in a different tone for 90 more seconds.

*4: The DPF system warning light may not turn off when the engine oil change reminder light is on. In this event, have the vehicle inspected by any authorized Toyota dealer or repairer, or another duly qualified and equipped professional.

*5: To determine whether or not your vehicle has a DPF system, contact any authorized Toyota dealer or repairer, or another duly qualified and equipped professional.

■ **Passenger detection sensor and passenger seat belt reminder**

- If luggage is placed on a passenger seat, the passenger detection sensor may cause the warning light to flash even if a passenger is not sitting in the seat.
- If a cushion is placed on the seat, the sensor may not detect a passenger, and the warning light may not operate properly.

■ **If the malfunction indicator lamp comes on while driving**

For some models, the malfunction indicator lamp will come on if the fuel tank becomes completely empty. If the fuel tank is empty, refuel the vehicle immediately. The malfunction indicator lamp will go off after several trips.

If the malfunction indicator lamp does not go off, contact any authorized Toyota dealer or repairer, or another duly qualified and equipped professional as soon as possible.

■ **Warning buzzer**

In some cases, the buzzer may not be heard because of noisy place or an audio sound.

■ **Electric power steering system warning light (warning buzzer)**

When the battery charge becomes insufficient or the voltage temporarily drops, the electric power steering system warning light may come on and the warning buzzer may sounds.

■ **If the engine oil change reminder light flashes (diesel engine with a DPF system)**

Repeated short trips and/or low-speed driving may cause the oil to degrade sooner than usual, regardless of the actual distance driven. If this happens, the engine oil change reminder light will flash.

■ **Engine oil change reminder light comes on (diesel engine only)**

▶ Vehicles without a DPF system

Replace the engine oil and oil filter when the engine oil change reminder light does not come on even if you have driven over 40000 km (25000 miles) after the engine oil was changed.

There is a possibility that the engine oil change reminder light has been illuminated when you have driven less than 40000 km (25000 miles) based on a usage or driving condition.

▶ Vehicles with a DPF system

Replace the engine oil and oil filter when the engine oil change reminder light does not come on even if you have driven over 15000 km (9300 miles) after the engine oil was changed.

There is a possibility that the engine oil change reminder light has been illuminated when you have driven less than 15000 km (9300 miles) based on a usage or driving condition.

■ **When the tire pressure warning light comes on (vehicles with a tire pressure warning system)**

Inspect the appearance of the tire to check that the tire is not punctured.

If the tire is punctured: →P. 418, 433

If the tire is not punctured:

Carry out the following procedure after the tire temperature has lowered sufficiently.

- Check the tire inflation pressure and adjust to the appropriate level.
- If the warning light does not go out even after several minutes, check that the tire inflation pressure is at the specified level and carry out initialization.

The warning light may come on again if the above operations are conducted without first allowing the tire temperature to lower sufficiently.

■ **The tire pressure warning light may come on due to natural causes (vehicles with a tire pressure warning system)**

The tire pressure warning light may come on due to natural causes such as natural air leaks and tire inflation pressure changes caused by temperature. In this case, adjusting the tire inflation pressure will turn off the warning light (after a few minutes).

■ **When a tire is replaced with a spare tire (vehicles with a tire pressure warning system)**

The spare tire is not equipped with a tire pressure warning valve and transmitter. If a tire goes flat, the tire pressure warning light will not turn off even though the flat tire has been replaced with the spare tire. Replace the spare tire with the repaired tire and adjust the tire inflation pressure. The tire pressure warning light will go off after a few minutes.

■ **If the tire pressure warning system is not functioning (vehicles with a tire pressure warning system)**

The tire pressure warning system will be disabled in the following conditions: (When the condition becomes normal, the system will work properly.)

- If tires not equipped with tire pressure warning valves and transmitters are used
- If the ID code on the tire pressure warning valves and transmitters is not registered in the tire pressure warning computer
- If the tire inflation pressure is 500 kPa (5.1 kgf/cm² or bar, 73 psi) or higher

The tire pressure warning system may be disabled in the following conditions: (When the condition becomes normal, the system will work properly.)

- If electronic devices or facilities using similar radio wave frequencies are nearby
 - If a radio set at a similar frequency is in use in the vehicle
 - If a window tint that affects the radio wave signals is installed
 - If there is a lot of snow or ice on the vehicle, particularly around the wheels or wheel housings
 - If non-genuine Toyota wheels are used (Even if you use Toyota wheels, the tire pressure warning system may not work properly with some types of tires.)
 - If tire chains are used
- **If the tire pressure warning light frequently comes on after blinking for 1 minute (vehicles with a tire pressure warning system)**
- If the tire pressure warning light frequently comes on after blinking for 1 minute when the engine switch is turned on, have it checked by any authorized Toyota dealer or repairer, or another duly qualified and equipped professional.

**WARNING****■ When the electric power steering system warning light comes on**

The steering wheel may become extremely heavy.

If the steering wheel becomes heavier than usual when operating, hold firmly and operate using more force than usual.

■ When driving to clean the DPF catalytic converter

When driving, pay sufficient attention to weather, road conditions, terrain and traffic conditions, and be sure to observe traffic laws and/or regulations. Failure to do so may cause an unexpected accident, resulting in death or serious injury.

■ If the tire pressure warning light comes on (vehicles with a tire pressure warning system)

Be sure to observe the following precautions. Failure to do so could cause a loss of vehicle control and result in death or serious injury.

- Stop your vehicle in a safe place as soon as possible. Adjust the tire inflation pressure immediately.
- If the tire pressure warning light comes on even after tire inflation pressure adjustment, it is probable that you have a flat tire. Check the tires. If a tire is flat, change it with the spare tire and have the flat tire repaired by the nearest authorized Toyota dealer or repairer, or another duly qualified and equipped professional.
- Avoid abrupt maneuvering and braking. If the vehicle tires deteriorate, you could lose control of the steering wheel or the brakes.

■ If a blowout or sudden air leakage should occur (vehicles with a tire pressure warning system)

The tire pressure warning system may not activate immediately.

 NOTICE

■ **If the fuel filter warning light comes on (diesel engine only)**

Never drive the vehicle with the warning light on. Continued driving with water accumulated in the fuel filter will damage the fuel injection pump.



■ **When the DPF system warning light comes on (diesel engine with a DPF system)**





If the DPF system warning light is left on without performing cleaning, after an additional 100 to 300 km (62 to 187 miles), the malfunction indicator lamp may come on. If this happens, have the vehicle inspected by any authorized Toyota dealer or repairer, or another duly qualified and equipped professional immediately.

■ **To ensure the tire pressure warning system operates properly (vehicles with a tire pressure warning system)**

Do not install tires with different specifications or makers, as the tire pressure warning system may not operate properly.

Interior buzzer	Exterior buzzer	Warning light	Warning light/Details/Actions
Continuous	Continuous	 (Flashes in yellow)	<p>Smart entry & start system indicator light (Multidrive)</p> <p>The electronic key was carried outside the vehicle and the driver's door was opened and closed while any shift position other than P was selected without turning off the engine switch.</p> <p>→ Change the shift position to P.</p> <p>→ Bring the electronic key back into the vehicle.</p>

Interior buzzer	Exterior buzzer	Warning light	Warning light/Details/Actions
Once	3 times	 <p>(Flashes in yellow)</p>	<p>Smart entry & start system indicator light</p> <p>Vehicles with a Multidrive: The electronic key was carried outside the vehicle and the driver's door was opened and closed while the shift position P was selected without turning off the engine switch.</p> <p>Vehicles with a manual transmission: The electronic key was carried outside the vehicle and a door other than the driver's door was opened and closed while the engine switch was in a mode other than off.</p> <p>→ Turn the engine switch off or bring the electronic key back into the vehicle.</p>
Once	3 times	 <p>(Flashes in yellow)</p>	<p>Smart entry & start system indicator light</p> <p>Indicates that a door other than the driver's door has been opened and closed with the engine switch in any mode other than off and the electronic key outside of the detection area.</p> <p>→ Confirm the location of the electronic key.</p>
Once	Continuous (5 seconds)	 <p>(Flashes in yellow)</p>	<p>Smart entry & start system indicator light</p> <p>An attempt was made to exit the vehicle with the electronic key and lock the doors without first turning the engine switch off.</p> <p>→ Turn the engine switch off and lock the doors again.</p>

Interior buzzer	Exterior buzzer	Warning light	Warning light/Details/Actions
Once	—	 (Flashes in yellow for 15 seconds.)	Smart entry & start system indicator light Indicates that the electronic key is not present when attempting to start the engine. → Confirm the location of the electronic key.
9 times	—	 (Flashes in yellow)	Smart entry & start system indicator light An attempt was made to drive when the regular key was not inside the vehicle. → Confirm that the electronic key is inside the vehicle.
Once	—	 (Flashes in yellow for 15 seconds.)	Smart entry & start system indicator light Indicates that the electronic key battery is low. → Replace the battery. (→P. 367)
Once	—	 (Flashes quickly in green for 15 seconds.)	Smart entry & start system indicator light Indicates that the steering lock has not been released. → Release the steering lock. (→P. 188)
Once	—	 (Flashes in yellow for 30 seconds.)	Smart entry & start system indicator light <ul style="list-style-type: none"> • When the doors were unlocked with the mechanical key and then the engine switch was pressed, the electronic key could not be detected in the vehicle. • The electronic key could not be detected in the vehicle even after the engine switch was pressed two consecutive times. → Vehicles with a Multidrive: Touch the electronic key to the engine switch while depressing the brake pedal. → Vehicles with a manual transmission: Touch the electronic key to the engine switch while depressing the clutch pedal.

If you have a flat tire (vehicles with a spare tire)

Your vehicle is equipped with a spare tire. The flat tire can be replaced with the spare tire.

For details about tires: →P. 347



WARNING

■ If you have a flat tire

Do not continue driving with a flat tire.

Driving even a short distance with a flat tire can damage the tire and the wheel beyond repair, which could result in an accident.

Before jacking up the vehicle

- Stop the vehicle on a hard, flat surface.
- Set the parking brake.
- Shift the shift lever to P (Multidrive) or R (manual transmission).
- Stop the engine.
- Turn on the emergency flashers. (→P. 394)

Location of the spare tire, jack and tool bag

■ Location

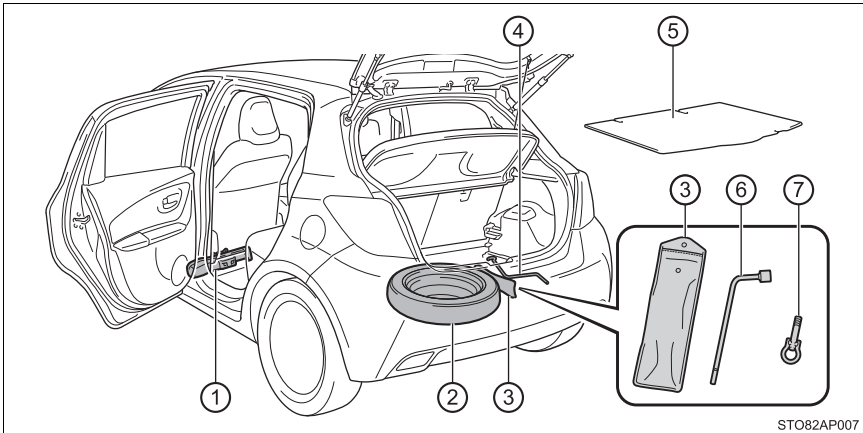

- ① Jack
- ② Spare tire
- ③ Tool bag
- ④ Jack handle
- ⑤ Luggage floor cover
- ⑥ Wheel nut wrench
- ⑦ Towing eyelet

**WARNING****■ Using the tire jack**

Observe the following precautions.

Improper use of the tire jack may cause the vehicle to suddenly fall off the jack, leading to death or serious injury.

- Do not use the tire jack for any purpose other than replacing tires or installing and removing tire chains.
- Only use the tire jack that comes with this vehicle for replacing a flat tire. Do not use it on other vehicles, and do not use other tire jacks for replacing tires on this vehicle.
- Put the jack properly in its jack point.
- Do not put any part of your body under the vehicle while it is supported by the jack.
- Do not start the engine or drive the vehicle while the vehicle is supported by the jack.
- Do not raise the vehicle while someone is inside.
- When raising the vehicle, do not put an object on or under the jack.
- Do not raise the vehicle to a height greater than that required to replace the tire.
- Use a jack stand if it is necessary to get under the vehicle.
- When lowering the vehicle, make sure that there is no-one near the vehicle. If there are people nearby, warn them vocally before lowering.

Taking out the jack

- 1 Move the front left seat to the front most position and remove the cover.

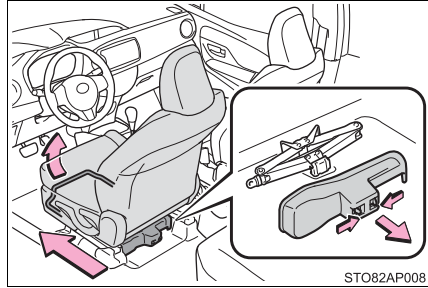

- 2 Take out the jack.

- ① For tightening
- ② For loosening

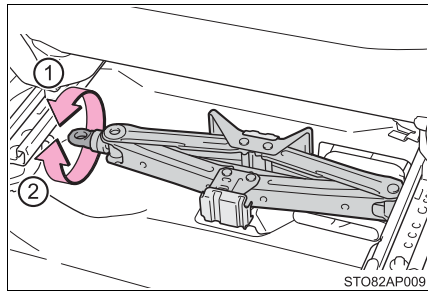

Taking out the spare tire

▶ Vehicles with a compact spare tire

- 1 Vehicles with a deck board: Lift the deck board and pull it toward you to remove it. (→P. 307)
- 2 Remove the luggage floor cover.

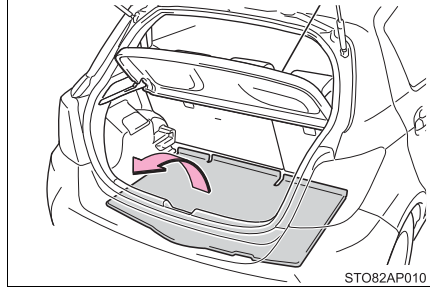

- 3 Remove the spare wheel cushion, then loosen the center fastener.

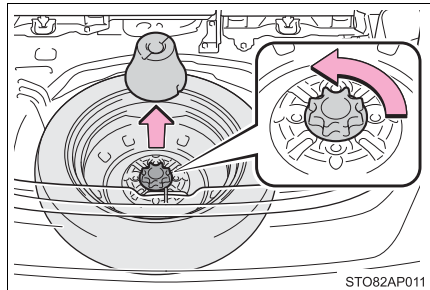

▶ Vehicles with a full-size spare tire

- 1 Lift the deck board and pull it toward you to remove it. (→P. 307)
- 2 Remove the spare wheel cushion, then loosen the center fastener.

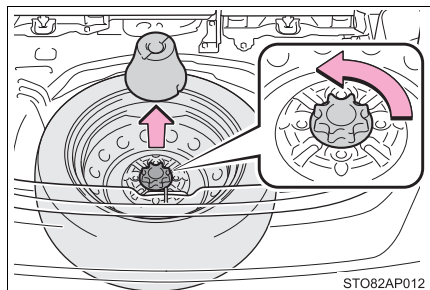

Replacing a flat tire

- 1 Chock the tires.

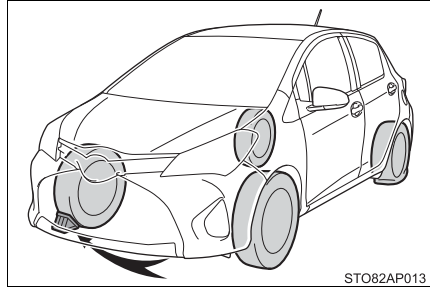

STO82AP013

Flat tire		Wheel chock positions
Front	Left-hand side	Behind the rear right-hand side tire
	Right-hand side	Behind the rear left-hand side tire
Rear	Left-hand side	In front of the front right-hand side tire
	Right-hand side	In front of the front left-hand side tire

- 2 For vehicles with steel wheels, remove the wheel ornament using the wrench.

To protect the wheel ornament, place a rag between the wrench and the wheel ornament.

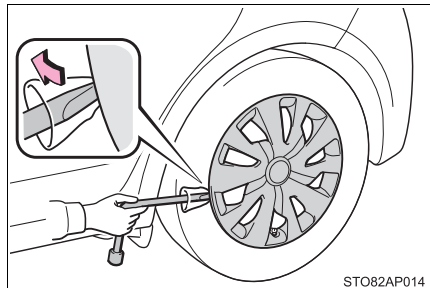

STO82AP014

- 3 Slightly loosen the wheel nuts (one turn).

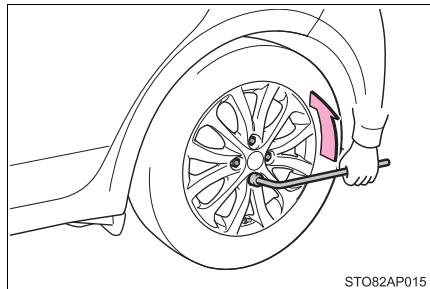

STO82AP015

- 4 Turn the tire jack portion (A) by hand until the notch of the jack is in contact with the jack point.

The jack point guides are located under the rocker panel. They indicate the jack point positions.

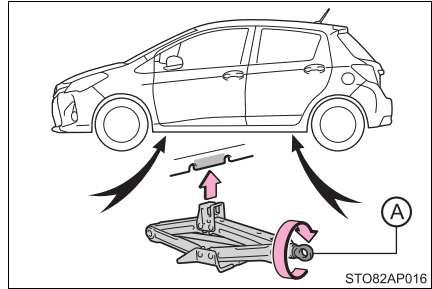

- 5 Raise the vehicle until the tire is slightly raised off the ground.

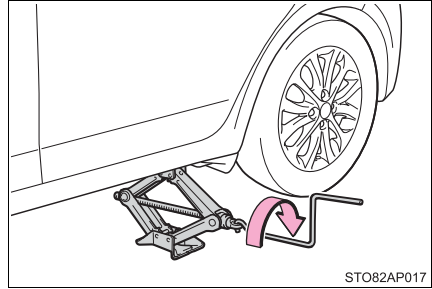

- 6 Remove all the wheel nuts and the tire.

When resting the tire on the ground, place the tire so that the wheel design faces up to avoid scratching the wheel surface.

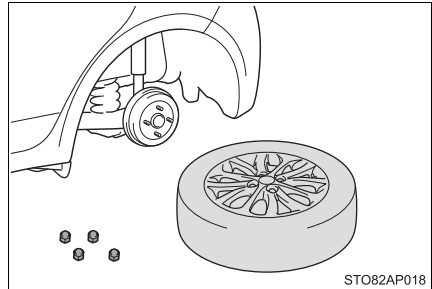

 **WARNING****■ Replacing a flat tire**

- Observe the following precautions.

Failure to do so may result in serious injury:

- Do not try to remove the wheel ornament by hand. Take due care in handling the ornament to avoid unexpected personal injury.
- Do not touch the disc wheels or the area around the brakes immediately after the vehicle has been driven.

After the vehicle has been driven the disc wheels and the area around the brakes will be extremely hot. Touching these areas with hands, feet or other body parts while changing a tire, etc. may result in burns.

- Failure to follow these precautions could cause the wheel nuts to loosen and the tire to fall off, resulting in death or serious injury.
 - Have the wheel nuts tightened with a torque wrench to 103 N·m (10.5 kgf·m, 76 ft·lbf) as soon as possible after changing wheels.
 - When installing a tire, only use wheel nuts that have been specifically designed for that wheel.
 - If there are any cracks or deformations in the bolt screws, nut threads or bolt holes of the wheel, have the vehicle inspected by any authorized Toyota dealer or repairer, or another duly qualified and equipped professional.
 - When installing the wheel nuts, be sure to install them with the tapered ends facing inward. (→P. 363)

Installing the spare tire

- 1 Remove any dirt or foreign matter from the wheel contact surface.

If foreign matter is on the wheel contact surface, the wheel nuts may loosen while the vehicle is in motion, causing the tire to come off.

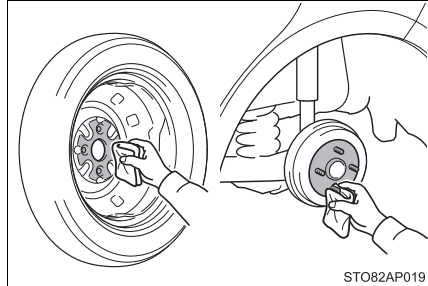

STO82AP019

- 2 Install the tire and loosely tighten each wheel nut by hand by approximately the same amount.

When replacing a steel wheel with a steel wheel (including a compact spare tire), tighten the wheel nuts until the tapered portion comes into loose contact with the disc wheel seat.

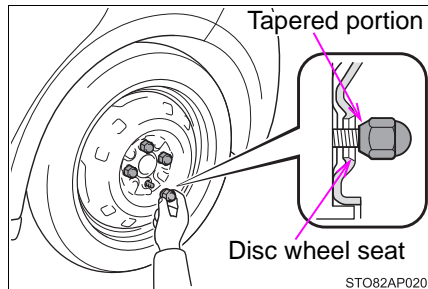

STO82AP020

When replacing an aluminum wheel with a compact spare tire, tighten the wheel nuts until the tapered portion comes into loose contact with the disc wheel seat.

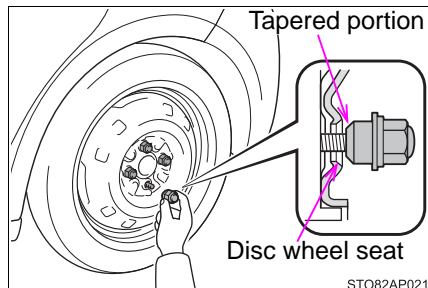

STO82AP021

When replacing an aluminum wheel with an aluminum wheel, turn the wheel nuts until the washers come into contact with the disc wheel.

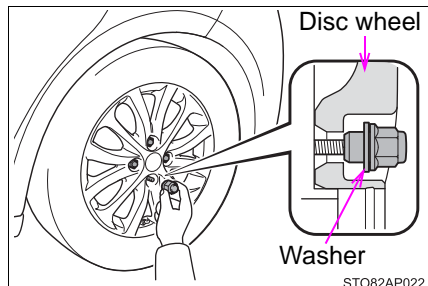

STO82AP022

- 3 Lower the vehicle.

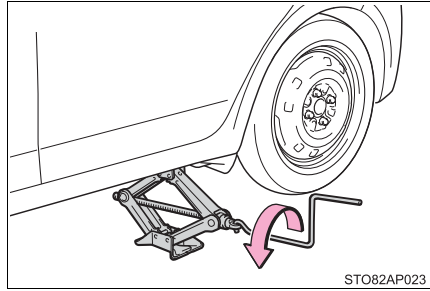

- 4 Firmly tighten each wheel nut two or three times in the order shown in the illustration.

Tightening torque:

103 N·m (10.5 kgf·m, 76 ft·lbf)

Do not use other tools or any additional leverage other than your hands, such as a hammer, pipe or your foot.

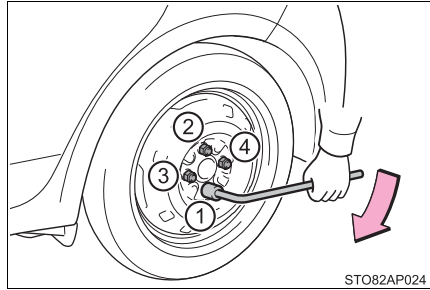

- Vehicles with steel wheels (except compact spare tire)

- 5 Reinstall the wheel ornament.

Align the cutout of the wheel ornament with the valve stem as shown.

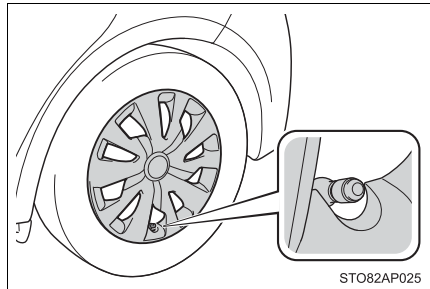

- Vehicles with aluminum wheels

- 5 Remove the center wheel ornament by pushing from the reverse side.

Be careful not to lose the wheel ornament.

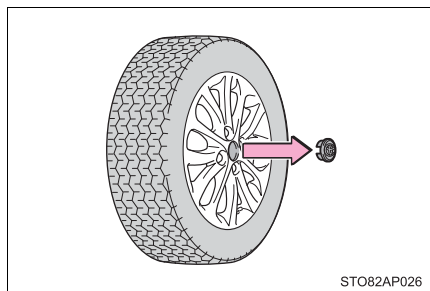

- 6 Stow the flat tire, tire jack and all tools.

■ The compact spare tire

- The compact spare tire is identified by the label “TEMPORARY USE ONLY” on the tire sidewall.
Use the compact spare tire temporarily, and only in an emergency.
- Make sure to check the tire inflation pressure of the compact spare tire. (→P. 483)

■ After completing the tire change (vehicles with a tire pressure warning system)

The tire pressure warning system must be reset. (→P. 348)

■ When using the spare tire (include compact spare tire) (vehicles with a tire pressure warning system)

As the spare tire is not equipped with a tire pressure warning valve and transmitter, low inflation pressure of the spare tire will not be indicated by the tire pressure warning system. Also, if you replace a flat tire with the spare tire after the tire pressure warning light comes on, the light remains on.

■ If you have a flat front tire on a road covered with snow or ice

Install the compact spare tire on one of the rear wheels of the vehicle. Perform the following steps and fit tire chains to the front tires:

- 1 Replace a rear tire with the compact spare tire.
- 2 Replace the flat front tire with the tire removed from the rear of the vehicle.
- 3 Fit tire chains to the front tires.

■ Certification for the jack



Manufacturer's Declaration of Conformity

Manufacturer:

Kawasaki Industrial Co., Ltd.
4618 Mukaijima Shimada, Shizuoka, Japan

The EU Directives covered by this Declaration

2006/42/EC Machinery Directive

The product covered by this declaration

JACK SUB-ASSY,PANTOGRAPH

model

0.8ton , 1.1ton , 1.35ton , 1.5ton

The basis on which conformity is being declared

The product identified above complies with the requirements of
the Machinery Directive
Directive above by meeting following standards

JIS D 8103

The technical documentation required to demonstrate that the product
meets the requirement the Machinery Directive has been compiled by
the signatory below and is available for inspection by the relevant
enforcement authorities.

A sample of the product has been tested by the manufacturer

Technical File No: KSF-201-00-01

The CE mark was first applied in:2010

Done at Shizuoka, Japan

Signature:

Koji Kawasaki

PRESIDENT ,Kawasaki industrial Co., Ltd.

Date of Issue: **25 December.2009**



Manufacturer's Declaration of Conformity

Manufacturer :

ARIKAN KRİKO A.Ş
Organize Sanayi Bölgesi 2.Cd.26110 ESKİŞEHİR / TURKEY

The EU Directives covered by this Declaration

2006 / 42 / EC Machinery Directive

The product covered by this declaration

JACK SUB-ASSY. PANTOGRAPH
model
0.8 ton , 1.1 ton

The basis on which conformity is being declared

The product identified above complies with the requirements of
the Machinery Directive
Directive above by meeting following standards

857 – ISO 8720

The technical documentation required to demonstrate that the product
meets the requirement the Machinery Directive has been compiled by
the signatory below and is available for inspection by the relevant
enforcement authorities.

A sample of the product has been tested by the manufacturer

Technical File No :2010-TOYOTA JACK-ISO8720-1

The CE mark was first applied in:2010

Done at Shizuoka , Japan

Ahmet ARIKAN
General Manager

Signature :

Date of Issue : 24.08.2010

 **WARNING****■ When using the full-size spare tire**

- Replace the full-size spare tire with a standard tire as soon as possible.
- Avoid sudden acceleration, abrupt steering, sudden braking and shifting operations that cause sudden engine braking.

■ When using the compact spare tire

- Remember that the compact spare tire provided is specifically designed for use with your vehicle. Do not use your compact spare tire on another vehicle.
- Do not use more than one compact spare tire simultaneously.
- Replace the compact spare tire with a standard tire as soon as possible.
- Avoid sudden acceleration, abrupt steering, sudden braking and shifting operations that cause sudden engine braking.

■ When storing the compact spare tire

Be careful not to catch fingers or other body parts between the compact spare tire and the body of the vehicle.

■ After using the tools and jack

Before driving, make sure all the tools and jack are securely in place in their storage location to reduce the possibility of personal injury during a collision or sudden braking.

■ When the compact spare tire is attached

The vehicle speed may not be correctly detected, and the following systems may not operate correctly:

- ABS
- Brake assist
- VSC (if equipped)
- TRC (if equipped)
- Cruise control (if equipped)
- Navigation system (if equipped)

■ Speed limit when using the compact spare tire

Do not drive at speeds in excess of 80 km/h (50 mph) when a compact spare tire is installed on the vehicle.

The compact spare tire is not designed for driving at high speeds. Failure to observe this precaution may lead to an accident causing death or serious injury.

**NOTICE****■ Do not drive the vehicle with a flat tire**

Do not continue driving with a flat tire.

Driving even a short distance with a flat tire can damage the tire and the wheel beyond repair.

■ Be careful when driving over bumps with the compact spare tire installed on the vehicle

The vehicle becomes lower when driving with the compact spare tire compared to when driving with standard tires. Be careful when driving over uneven road surfaces.

■ Driving with tire chains and the compact spare tire

Do not fit tire chains to the compact spare tire.

Tire chains may damage the vehicle body and adversely affect driving performance.

■ When replacing the tires (vehicles with a tire pressure warning system)

When removing or fitting the wheels, tires or the tire pressure warning valve and transmitter, contact any authorized Toyota dealer or repairer, or another duly qualified and equipped professional as the tire pressure warning valve and transmitter may be damaged if not handled correctly.

If you have a flat tire (vehicles with an emergency tire puncture repair kit)

Your vehicle is not equipped with a spare tire, but instead is equipped with an emergency tire puncture repair kit.

A puncture caused by a nail or screw passing through the tire tread can be repaired temporarily using the emergency tire puncture repair kit. (The kit contains a bottle of sealant. The sealant can be used only once to temporarily repair one tire without removing the nail or screw from the tire.) Depending on the damage, this kit cannot be used to repair the tire. (→P. 436)

After temporarily repairing the tire with the kit, have the tire repaired or replaced by any authorized Toyota dealer or repairer, or another duly qualified and equipped professional. Repairs conducted using the emergency tire puncture repair kit are only a temporary measure. Have the tire repaired and replaced as soon as possible.



WARNING

■ If you have a flat tire

Do not continue driving with a flat tire.

Driving even a short distance with a flat tire can damage the tire and the wheel beyond repair, which could result in an accident.

Before repairing the tire

- Stop the vehicle in a safe place on a hard, flat surface.
- Set the parking brake.
- Shift the shift lever to P (Multidrive) or N (manual transmission).
- Stop the engine.
- Turn on the emergency flashers. (→P. 394)

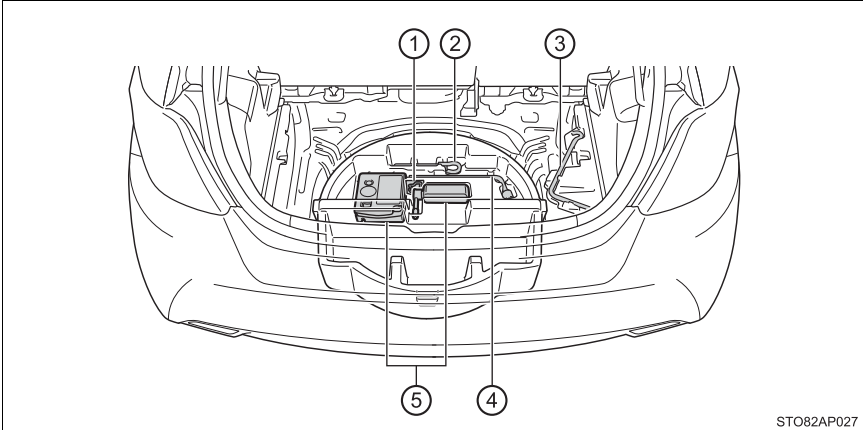
Location of the emergency tire puncture repair kit

- ① Wheel cap clip (if equipped)
- ② Towing eyelet
- ③ Jack handle*
- ④ Wheel nut wrench*
- ⑤ Emergency tire puncture repair kit

*: Use of the jack, jack handle and wheel nut wrench. (if equipped) (→P. 419)
A jack, jack handle and wheel nut wrench can be purchased at any authorized Toyota dealer or repairer, or another duly qualified and equipped professional.

Emergency tire puncture repair kit components

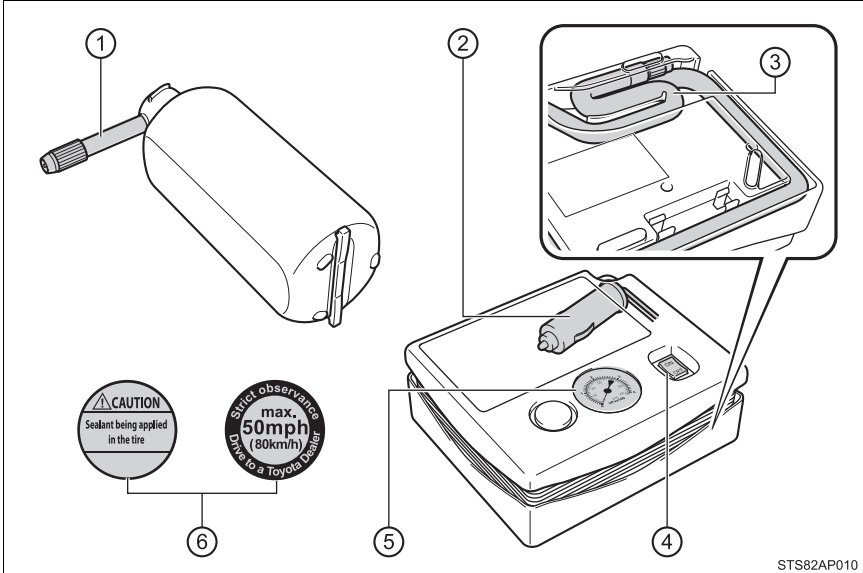

① Nozzle

② Power plug

③ Hose

④ Compressor switch

⑤ Air pressure gauge

⑥ Stickers

Before performing emergency repair

Check the degree of the tire damage.

- Do not remove the nail or screw from the tire. Removing the object may widen the opening and prevent emergency repair with the repair kit.
- To avoid sealant leakage, move the vehicle until the area of the puncture, if known, is positioned at the top of the tire.

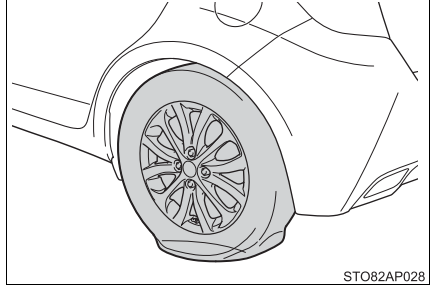

■ **In the following cases, the tire cannot be repaired with the emergency tire puncture repair kit. Contact any authorized Toyota dealer or repairer, or another duly qualified and equipped professional.**

- When the tire is damaged due to driving without sufficient air pressure
- When there are any cracks or damage at any location on the tire, such as on the side wall, except the tread
- When the tire is visibly separated from the wheel
- When the cut or damage to the tread is 4 mm (0.16 in.) long or more
- When the wheel is damaged
- When two or more tires have been punctured
- When more than 2 sharp objects such as nails or screws have passed through the tread on a single tire
- When the sealant has expired

Taking out the emergency tire puncture repair kit

- 1 Vehicles with a deck board: Lift the deck board and pull it toward you to remove it. (→P. 307)
- 2 Remove the luggage floor cover.

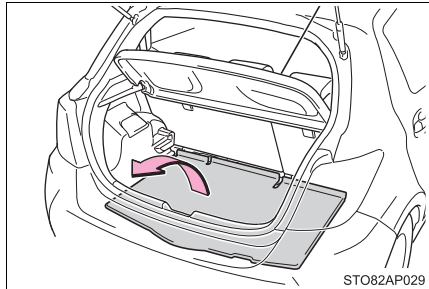

- 3 Take out the emergency tire puncture repair kit.

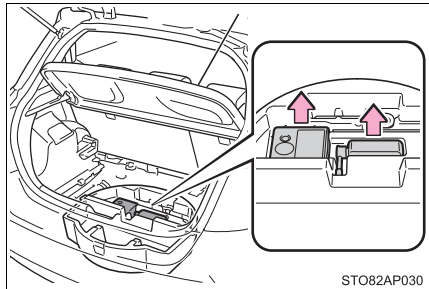

Emergency repair method

- 1 Take out the repair kit from the tool box.
When taking out the bottle from the original bag, do not tear or discard the bag.
- 2 Remove the valve cap from the valve of the punctured tire.

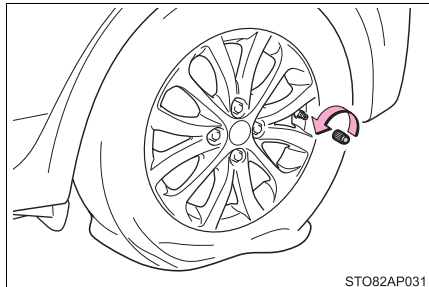

- 3 Remove the cap from the bottle.

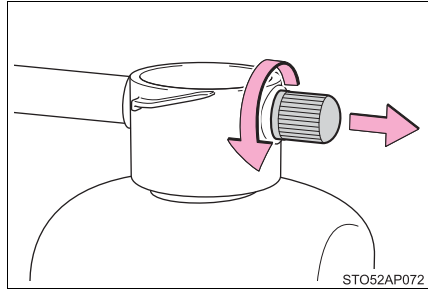

- 4 Connect the nozzle to the valve.

Screw the end of the nozzle clockwise as far as possible.

The bottle should hang vertically without contacting the ground. If the bottle does not hang vertically, move the vehicle so that the tire valve is located properly.

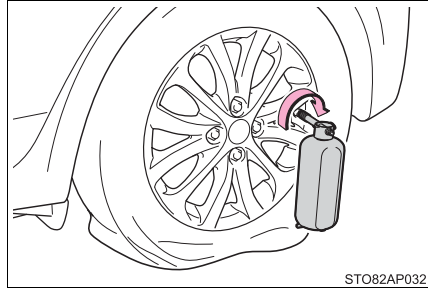

- 5 Make sure that the compressor switch is off.

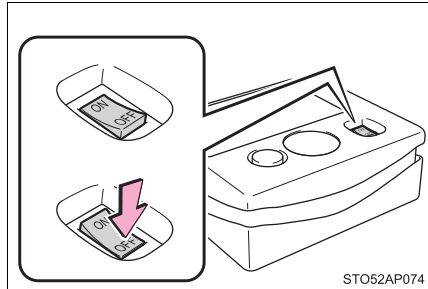

- 6 Remove the power plug from the compressor.

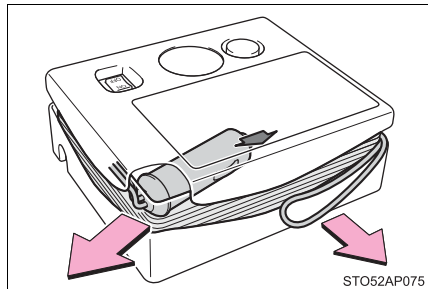

- 7 Pull the hose out from the compressor.

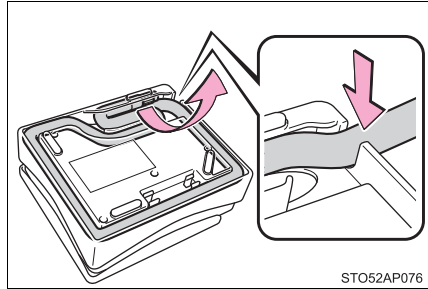

- 8 Connect the power plug to the power outlet socket or cigarette lighter socket. (→P. 311, 312)

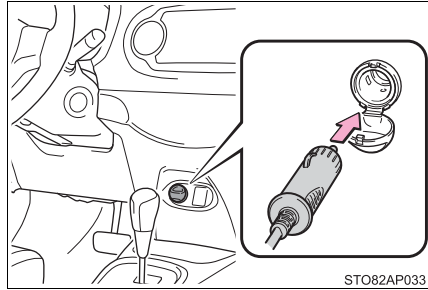

- 9 Attach the 2 stickers as shown.

Remove any dirt and moisture from the wheel before attaching the label. If it is impossible to attach the label, make sure to tell any authorized Toyota dealer or repairer, or another duly qualified and equipped professional when you have them repair and replace the tire that sealant is injected.

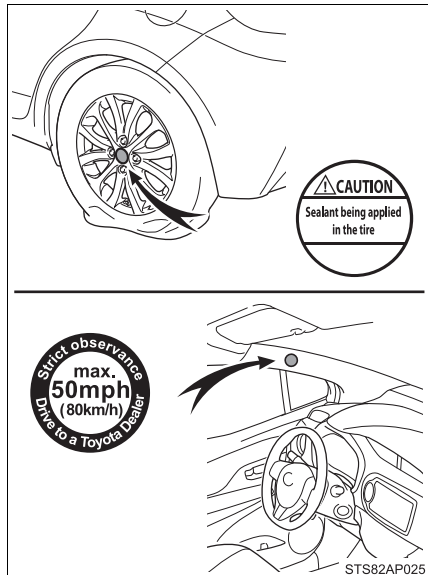

- 10** Connect the bottle to the compressor.

Screw the end of the hose clockwise as far as possible.

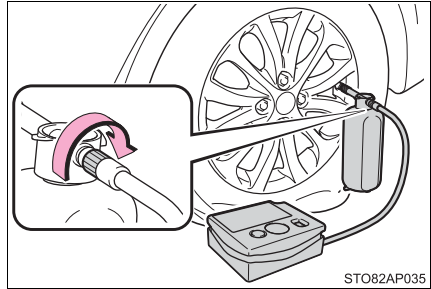

- 11** Check the specified tire inflation pressure.

Tire inflation pressure is specified on the label in the glove box.
(→P. 483)

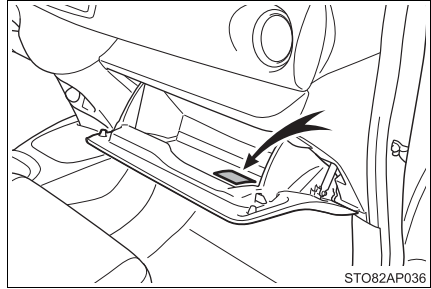

- 12** Start the engine.

- 13** To inject the sealant and inflate the tire, turn the compressor switch on.

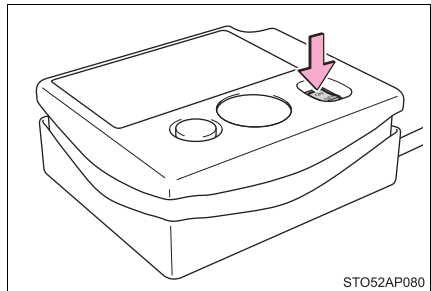

14 Inflate the tire until the specified air pressure is reached.

① The sealant will be injected and the pressure will surge and then gradually decrease.

② The air pressure gauge will display the actual tire inflation pressure about 1 minute (5 minutes at low temperature) after the switch is turned on.

③ Inflate the tire until the specified air pressure.

- If the tire inflation pressure is still lower than the specified point after inflation for 35 minutes with the switch on, the tire is too damaged to be repaired. Turn the compressor switch off and contact any authorized Toyota dealer or repairer, or another duly qualified and equipped professional.

- If the tire inflation pressure exceeds the specified air pressure, let out some air to adjust the tire inflation pressure. (→P. 443, 483)

15 With the compressor switch off, disconnect the nozzle from the valve on the tire and then pull out the power plug from the power outlet socket or cigarette lighter.

Some sealant may leak when the hose is removed.

16 Install the valve cap onto the valve of the emergency repaired tire.

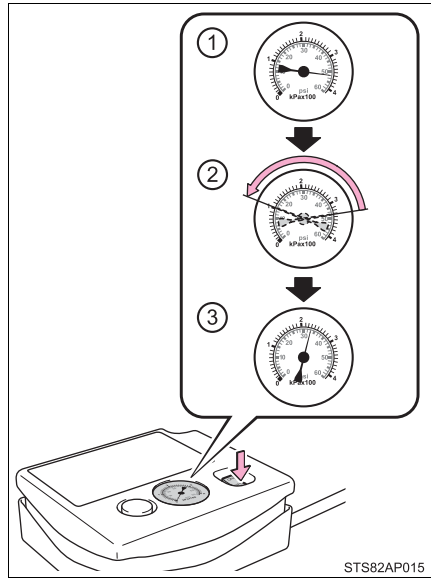

- 17** Disconnect the hose from the bottle and attach the cap to the bottle.

Place the bottle in the original bag and zip it.

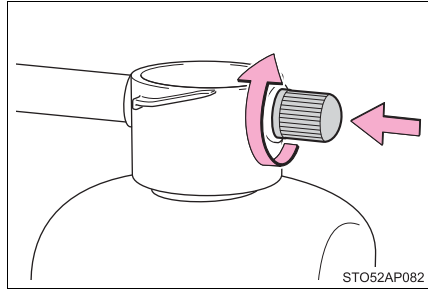

- 18** Temporarily store the bottle and compressor in the luggage compartment.

- 19** To spread the liquid sealant evenly within the tire, immediately drive safely for about 5 km (3 miles) below 80 km/h (50 mph).

- 20** After driving for about 5 km (3 miles), stop your vehicle in a safe place on a hard, flat surface and connect the compressor.

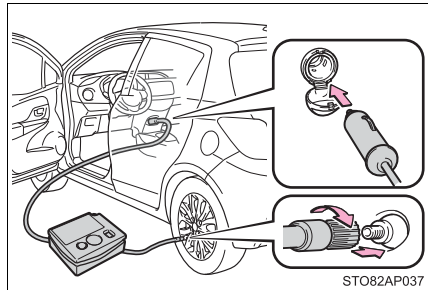

- 21** Turn the compressor switch on and wait for an approximately 5 seconds, and then turn it off. Check the tire inflation pressure.

- ① If the tire inflation pressure is under 130 kPa (1.3 kgf/cm² or bar, 19 psi): The puncture cannot be repaired. Contact any authorized Toyota dealer or repairer, or another duly qualified and equipped professional.

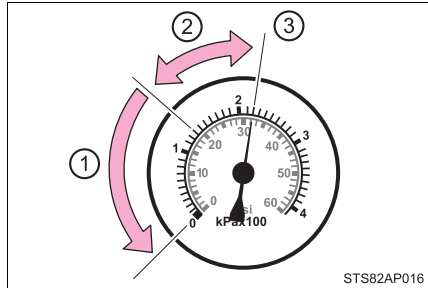

- ② If the tire inflation pressure is 130 kPa (1.3 kgf/cm² or bar, 19 psi) or higher, but less than the specified air pressure: Proceed to **22**.
 - ③ If the tire inflation pressure is the specified air pressure (→P. 483): Proceed to **23**.
- 22** Turn the compressor switch on to inflate the tire until the specified air pressure is reached. Drive for about 5 km (3 miles) and then perform **20**.
 - 23** Store the compressor in the luggage compartment.
 - 24** Taking precautions to avoid sudden braking, sudden acceleration and sharp turns, drive carefully at under 80 km/h (50 mph) to the nearest authorized Toyota dealer or repairer, or another duly qualified and equipped professional for tire repair or replacement.

■ **If the tire is inflated to more than the specified air pressure**

- 1** Press the button to let some air out.

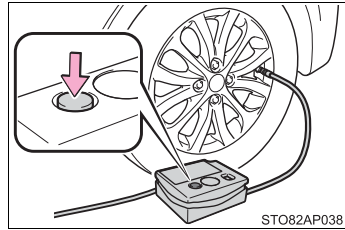

- 2** Check that the air pressure indicator shows the specified air pressure. If the air pressure is under the designated pressure, turn the compressor switch on again and repeat the inflation procedure until the specified air pressure is reached.

■ **The valve of a tire that has been repaired**

After a tire is repaired with the emergency tire puncture repair kit, the valve should be replaced.

■ Note for checking the emergency tire puncture repair kit

Check the sealant expiry date occasionally.

The expiry date is shown on the bottle. Do not use sealant whose expiry date has already passed. Otherwise, repairs conducted using the emergency tire puncture repair kit may not be performed properly.

■ Emergency tire puncture repair kit

- The sealant stored in the emergency tire puncture repair kit can be used only once to temporarily repair a single tire. If the sealant has been used and needs to be replaced, purchase a new bottle at any authorized Toyota dealer or repairer, or another duly qualified and equipped professional. The compressor is reusable.
- The sealant can be used when the outside temperature is from -30°C (-22°F) to 60°C (140°F).
- The repair kit is exclusively designed for size and type of tires originally installed on your vehicle. Do not use it for tires that a different size than the original ones, or for any other purposes.
- The sealant has a limited lifespan. The expiry date is marked on the bottle. The bottle of sealant should be replaced with a new bottle before the expiry date. Contact any authorized Toyota dealer or repairer, or another duly qualified and equipped professional for replacement.
- If the sealant gets on your clothes, it may stain.
- If the sealant adheres to a wheel or the surface of the vehicle body, the stain may not be removable if it is not cleaned at once. Immediately wipe away the sealant with a wet cloth.
- During operation of the repair kit, a loud operation noise is produced. This does not indicate a malfunction.
- Do not use to check or to adjust the tire pressure.

 **WARNING****■ Do not drive the vehicle with a flat tire**

Do not continue driving with a flat tire.

Driving even a short distance with a flat tire can damage the tire and the wheel beyond repair.

Driving with a flat tire may cause a circumferential groove on the side wall. In such a case, the tire may explode when using a repair kit.

■ Caution while driving

- Store the repair kit in the luggage room.
Injuries may result in the event of an accident or sudden braking.
- The repair kit is exclusively only for your vehicle.
Do not use repair kit on other vehicles, which could lead to an accident causing death or serious injury.
- Do not use repair kit for tires that are different size than the original ones, or for any other purpose. If the tires have not been completely repaired, it could lead to an accident causing death or serious injury.

■ Precautions for use of the sealant

- Ingesting the sealant is hazardous to your health. If you ingest sealant, consume as much water as possible, and then immediately consult a doctor.
- If sealant gets in eyes or adheres to skin, immediately wash it off with water. If discomfort persists, consult a doctor.

■ When fixing the flat tire

- Stop your vehicle in a safe and flat area.
- Do not touch the wheels or the area around the brakes immediately after the vehicle has been driven.
After the vehicle has been driven, the wheels and the area around the brakes may be extremely hot. Touching these areas with hands, feet or other body parts may result in burns.
- To avoid risk of burst or severe leakage, do not drop or damage the bottle. Visually inspect the bottle before use. Do not use a bottle with shock, crack, scratch, leakage or any other damage. In such case, immediately replace.

 **WARNING**

- Connect the valve and hose securely with the tire installed on the vehicle. If the hose is not properly connected to the valve, air leakage may occur as sealant may be sprayed out.
 - If the hose comes off the valve while inflating the tire, there is a risk that the hose will move abruptly due to air pressure.
 - After inflation of the tire has completed, the sealant may splatter when the hose is disconnected or some air is let out of the tire.
 - Follow the operation procedure to repair the tire. If the procedures not followed, the sealant may spray out.
 - Keep back from the tire while it is being repaired, as there is a chance of it bursting while the repair operation is being performed. If you notice any cracks or deformation of the tire, turn off the compressor switch and stop the repair operation immediately.
 - The repair kit may overheat if operated for a long period of time. Do not operate the repair kit continuously for more than 40 minutes.
 - Parts of the repair kit become hot during operation. Be careful when handling the repair kit during and after operation. Do not touch the metal part around the connecting area between the bottle and compressor. It will be extremely hot.
 - Do not attach the vehicle speed warning sticker to an area other than the one indicated. If the sticker is attached to an area where an SRS airbag is located, such as the pad of the steering wheel, it may prevent the SRS airbag from operating properly.
- **Driving to spread the liquid sealant evenly**
- Observe the following precautions to reduce the risk of accidents. Failing to do so may result in a loss of vehicle control and cause death or serious injury.
- Drive the vehicle carefully at a low speed. Be especially careful when turning and cornering.
 - If the vehicle does not drive straight or you feel a pull through the steering wheel, stop the vehicle and check the following.
 - Tire condition. The tire may have separated from the wheel.
 - Tire inflation pressure. If the tire inflation pressure is 130 kPa (1.3 kgf/cm² or bar, 19 psi) or less, the tire may be severely damaged.

 NOTICE**■ When performing an emergency repair**

- A tire should only be repaired with the emergency tire puncture repair kit if the damage is caused by a sharp object such as nail or screw passing through the tire tread.

Do not remove the sharp object from the tire. Removing the object may widen the opening and disenable emergency repair with the repair kit.

- The repair kit is not waterproof. Make sure that the repair kit is not exposed to water, such as when it is being used in the rain.
- Do not put the repair kit directly onto dusty ground such as sand at the side of the road. If the repair kit vacuums up dust etc., a malfunction may occur.

■ Precautions for the emergency tire puncture repair kit

- The repair kit power source should be 12 V DC suitable for vehicle use. Do not connect the repair kit to any other source.
- If gasoline splatters on the repair kit, the repair kit may deteriorate. Take care not to allow gasoline to contact it.
- Place the repair kit in a storage to prevent it from being exposed to dirt or water.
- Store the repair kit in the luggage room out of reach of children.
- Do not disassemble or modify the repair kit. Do not subject parts such as the air pressure indicator to impacts. This may cause a malfunction.

■ To avoid damage to the tire pressure warning valves and transmitters (vehicles with a tire pressure warning system)

When a tire is repaired with liquid sealants, the tire pressure warning valve and transmitter may not operate properly. If a liquid sealant is used, contact any authorized Toyota dealer or repairer, or another duly qualified and equipped professional or other qualified service shop as soon as possible. Make sure to replace the tire pressure warning valve and transmitter when replacing the tire. (→P. 348)

If the engine will not start

If the engine will not start even though correct starting procedures are being followed (→P. 182, 185), consider each of the following points:

The engine will not start even though the starter motor operates normally.

One of the following may be the cause of the problem:

- There may not be sufficient fuel in the vehicle's tank.
Gasoline engine: Refuel the vehicle.
Diesel engine: →P. 462
- The engine may be flooded. (gasoline engine)
Try to restart the engine again following correct starting procedures.
(→P. 182, 185)
- There may be a malfunction in the engine immobilizer system.
(→P. 74)

The starter motor turns over slowly, the interior lights and headlights are dim, or the horn does not sound or sounds at a low volume.

One of the following may be the cause of the problem:

- The battery may be discharged. (→P. 453)
- The battery terminal connections may be loose or corroded.

The starter motor does not turn over (vehicles with a smart entry & start system).

The engine starting system may be malfunctioning due to an electrical problem such as an open circuit or a blown fuse. However, an interim measure is available to start the engine. (→P. 449)

The starter motor does not turn over, the interior lights and headlights do not turn on, or the horn does not sound.

One of the following may be the cause of the problem:

- One or both of the battery terminals may be disconnected.
- The battery may be discharged. (→P. 453)
- There may be a malfunction in the steering lock system (vehicles with a smart entry & start system).

Contact any authorized Toyota dealer or repairer, or another duly qualified and equipped professional, if the problem cannot be repaired, or if repair procedures are unknown.

Emergency start function (vehicles with a smart entry & start system)

When the engine does not start, the following steps can be used as an interim measure to start the engine if the engine switch is functioning normally:

- 1 Set the parking brake.
- 2 Shift the shift lever to P (Multidrive) or N (manual transmission).
- 3 Turn the engine switch to ACCESSORY mode.
- 4 Press and hold the engine switch for about 15 seconds while depressing the brake pedal (Multidrive) or brake pedal and clutch pedal (manual transmission) firmly.

Even if the engine can be started using the above steps, the system may be malfunctioning. Have the vehicle inspected by any authorized Toyota dealer or repairer, or another duly qualified and equipped professional.

If the shift lever cannot be shifted from P (vehicles with a Multidrive)

If the shift lever cannot be shifted with your foot on the brake pedal, there may be a problem with the shift lock system (a system to prevent accidental operation of the shift lever). Have the vehicle inspected by any authorized Toyota dealer or repairer, or another duly qualified and equipped professional immediately. The following steps may be used as an emergency measure to ensure that the shift lever can be shifted:

- 1 Set the parking brake.
- 2 Vehicles without a smart entry & start system:
Turn the engine switch to the "ACC" position.
Vehicles with a smart entry & start system:
Turn the engine switch to ACCESSORY mode.
- 3 Depress the brake pedal.
- 4 Pry the cover up with a flathead screwdriver or equivalent tool.
To prevent damage to the cover, wrap the tip of the screwdriver with a rag.

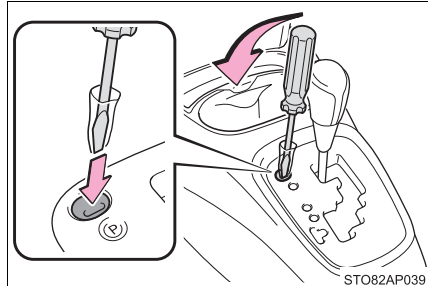

- 5 Press the shift lock override button.
The shift lever can be shifted while the button is pressed.

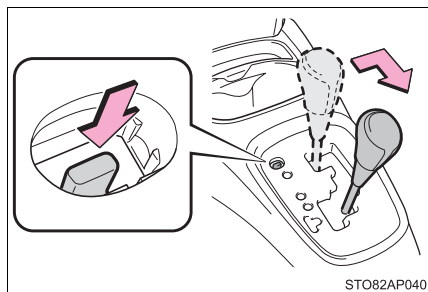

If the electronic key does not operate properly (vehicles with a smart entry & start system)

If communication between the electronic key and vehicle is interrupted (→P. 130) or the electronic key cannot be used because the battery is depleted, the smart entry & start system and wireless remote control cannot be used. In such cases, the doors can be opened and the engine can be started by following the procedure below.

Locking and unlocking the doors

Use the mechanical key (→P. 104) in order to perform the following operations:

- ① Unlocks all the doors
- ② Locks all the doors

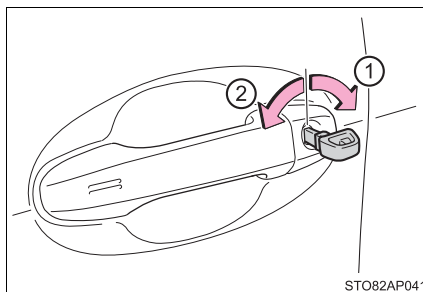

Starting the engine

- 1 Vehicles with a Multidrive:
Ensure that the shift lever is in P and depress the brake pedal.
Vehicles with a manual transmission:
Ensure that the shift lever is in N and depress the clutch pedal.

- 2 Touch the Toyota emblem side of the electronic key to the engine switch.

The engine switch will turn to IGNITION ON mode.

When the smart entry & start system is deactivated in customization setting, the engine switch will turn to ACCESSORY mode.

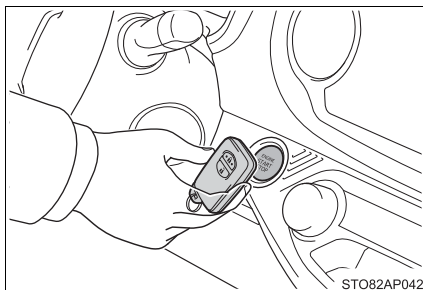

- 3 Firmly depress the brake pedal (Multidrive) or clutch pedal (manual transmission) and check that  (green) turns on.

- 4 Press the engine switch.

In the event that the engine still cannot be started, contact any authorized Toyota dealer or repairer, or another duly qualified and equipped professional.

■ Stopping the engine

Shift the shift lever to P (Multidrive) or N (manual transmission) and press the engine switch as you normally do when stopping the engine.

■ Replacing the key battery

As the above procedure is a temporary measure, it is recommended that the electronic key battery be replaced immediately when the battery is depleted. (→P. 367)

■ Changing engine switch modes

Release the brake pedal (Multidrive) or clutch pedal (manual transmission) and press the engine switch in step 3 above.

The engine does not start and modes will be changed each time the switch is pressed. (→P. 186)

■ When the electronic key does not work properly

Make sure that the smart entry & start system has not been deactivated in the customization setting. If it is off, turn the function on.

(Customizable features: →P. 489)

If the vehicle battery is discharged

The following procedures may be used to start the engine if the vehicle's battery is discharged.

You can also call any authorized Toyota dealer or repairer, or another duly qualified and equipped professional.

If you have a set of jumper (or booster) cables and a second vehicle with a 12-volt battery, you can jump start your vehicle by following the steps below.

- 1 Open the hood. (→P. 328)
- 2 Connect the jumper cables according to the following procedure:
 - ▶ 1KR-FE engine

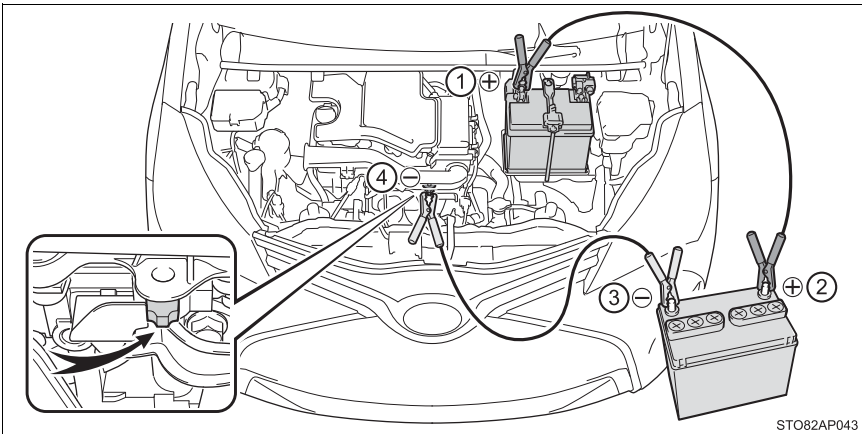

- ① Connect a positive jumper cable clamp to the positive (+) battery terminal on your vehicle.
- ② Connect the clamp on the other end of the positive cable to the positive (+) battery terminal on the second vehicle.
- ③ Connect a negative cable clamp to the negative (-) battery terminal on the second vehicle.
- ④ Connect the clamp at the other end of the negative cable to a solid, stationary, unpainted metallic point away from the battery and any moving parts, as shown in the illustration.

► 1NR-FE engine

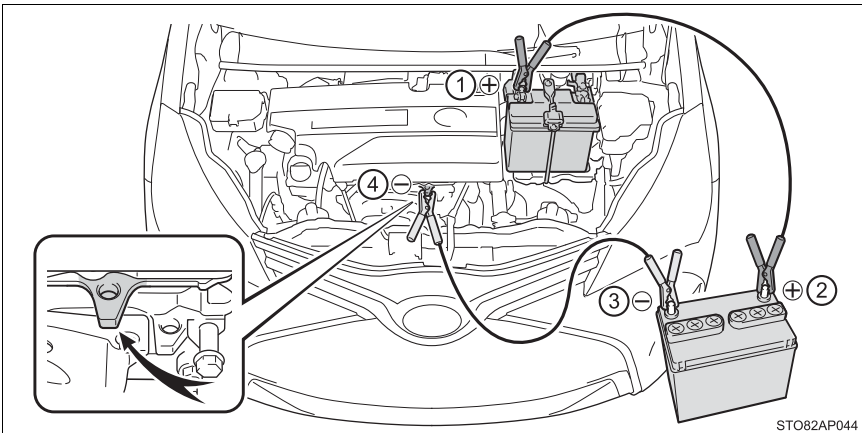

- ① Connect a positive jumper cable clamp to the positive (+) battery terminal on your vehicle.
- ② Connect the clamp on the other end of the positive cable to the positive (+) battery terminal on the second vehicle.
- ③ Connect a negative cable clamp to the negative (-) battery terminal on the second vehicle.
- ④ Connect the clamp at the other end of the negative cable to a solid, stationary, unpainted metallic point away from the battery and any moving parts, as shown in the illustration.

► 1ND-TV engine

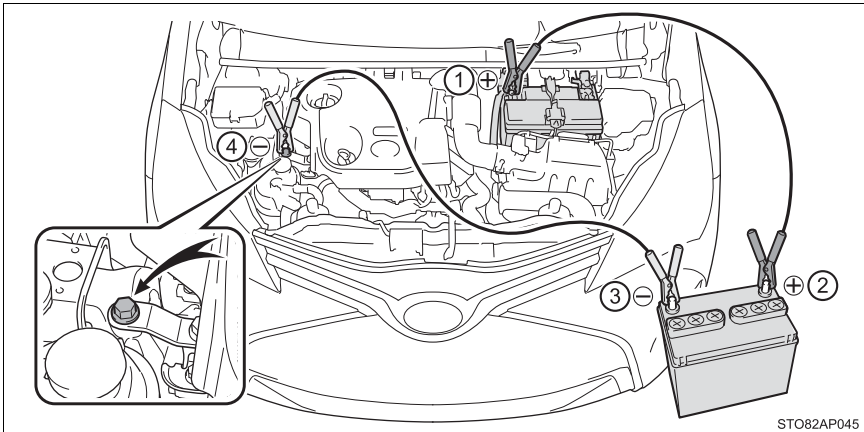

STO82AP045

- ① Connect a positive jumper cable clamp to the positive (+) battery terminal on your vehicle.
 - ② Connect the clamp on the other end of the positive cable to the positive (+) battery terminal on the second vehicle.
 - ③ Connect a negative cable clamp to the negative (-) battery terminal on the second vehicle.
 - ④ Connect the clamp at the other end of the negative cable to a solid, stationary, unpainted metallic point away from the battery and any moving parts, as shown in the illustration.
- 3 Start the engine of the second vehicle. Increase the engine speed slightly and maintain it at that level for approximately 5 minutes to recharge the battery of your vehicle.
 - 4 Vehicles with a smart entry & start system: Open and close any of the doors of your vehicle with the engine switch off.
 - 5 Maintain the engine speed of the second vehicle and turn the engine switch to "ON" position (vehicles without a smart entry & start system) or IGNITION ON mode (vehicles with a smart entry & start system), then start the vehicle's engine.

- 6 Once the vehicle's engine has started, remove the jumper cables in the exact reverse order from which they were connected.

Once the engine starts, have the vehicle inspected at any authorized Toyota dealer or repairer, or another duly qualified and equipped professional as soon as possible.

■ **Starting the engine when the battery is discharged (vehicles with a Multi-drive)**

The engine cannot be started by push-starting.

■ **To prevent battery discharge**

- Turn off the headlights and the audio system while the engine is off.
- Turn off any unnecessary electrical components when the vehicle is running at a low speed for an extended period, such as in heavy traffic.

■ **Charging the battery**

The electricity stored in the battery will discharge gradually even when the vehicle is not in use, due to natural discharge and the draining effects of certain electrical appliances. If the vehicle is left for a long time, the battery may discharge, and the engine may be unable to start. (The battery recharges automatically during driving.)

■ **Precautions when the battery is discharged (vehicles with a smart entry & start system)**

- In some cases, it may not be possible to unlock the doors using the smart entry & start system when the battery is discharged. Use the wireless remote control or the mechanical key to lock or unlock the doors.
- The engine may not start on the first attempt after the battery has recharged but will start normally after the second attempt. This is not a malfunction.
- The engine switch mode is memorized by the vehicle. When the battery is reconnected, the system will return to the mode it was in before the battery was discharged. Before disconnecting the battery, turn the engine switch off. If you are unsure what mode the engine switch was in before the battery discharged, be especially careful when reconnecting the battery.

 **WARNING****■ Avoiding battery fires or explosions**

Observe the following precautions to prevent accidentally igniting the flammable gas that may be emitted from the battery:

- Make sure each jumper cable is connected to the correct terminal and that it is not unintentionally in contact with anything other than the intended terminal.
- Do not allow the + and - clamps of the jumper cables to come into contact with each other.
- Do not smoke, use matches, cigarette lighters or allow open flame near the battery.

■ Battery precautions

The battery contains poisonous and corrosive acidic electrolyte, while related parts contain lead and lead compounds. Observe the following precautions when handling the battery:

- When working with the battery, always wear safety glasses and take care not to allow any battery fluids (acid) to come into contact with skin, clothing or the vehicle body.
- Do not lean over the battery.
- In the event that battery fluid comes into contact with the skin or eyes, immediately wash the affected area with water and seek medical attention. Place a wet sponge or cloth over the affected area until medical attention can be received.
- Always wash your hands after handling the battery support, terminals, and other battery-related parts.
- Do not allow children near the battery.

■ To prevent damage to the vehicle

Do not pull- or push-start the vehicle as the three-way catalytic converter (gasoline engine) or catalytic converter (diesel engine) may overheat and become a fire hazard.

 **NOTICE****■ When handling jumper cables**

When connecting the jumper cables, ensure that they do not become entangled in the cooling fans or engine drive belt.

If your vehicle overheats

The following may indicate that your vehicle is overheating:

- The high engine coolant temperature warning light (→P. 406) comes on or flashes, or a loss of engine power is experienced. (For example, the vehicle speed does not increase.)
- Steam comes out from under the hood.

Correction procedures

- 1 Stop the vehicle in a safe place and turn off the air conditioning system, and then stop the engine.
- 2 If you see steam:
Carefully lift the hood after the steam subsides.

If you do not see steam:
Carefully lift the hood.
- 3 After the engine has cooled down sufficiently, inspect the hoses and radiator core (radiator) for any leaks.

► Gasoline engine

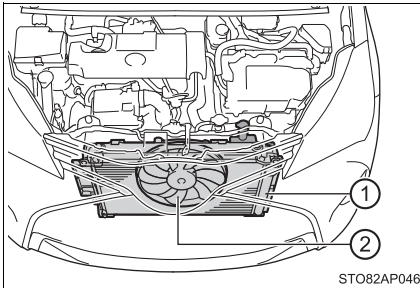

- 1 Radiator
- 2 Cooling fan

► Diesel engine

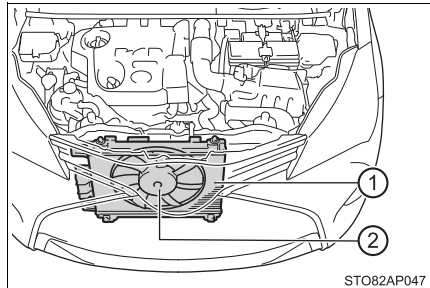

- 1 Radiator
- 2 Cooling fan

If a large amount of coolant leaks, immediately contact any authorized Toyota dealer or repairer, or another duly qualified and equipped professional.

- 4 The coolant level is satisfactory if it is between the “FULL” and “LOW” lines on the reservoir.

► Gasoline engine

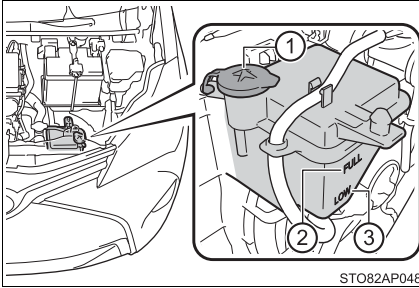

- ① Reservoir
- ② “FULL”
- ③ “LOW”

► Diesel engine

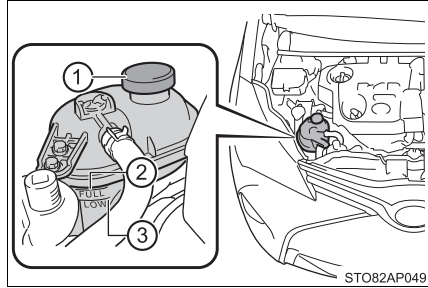

- ① Reservoir
- ② “FULL”
- ③ “LOW”

- 5 Add coolant if necessary.

Water can be used in an emergency if coolant is unavailable.

► Gasoline engine

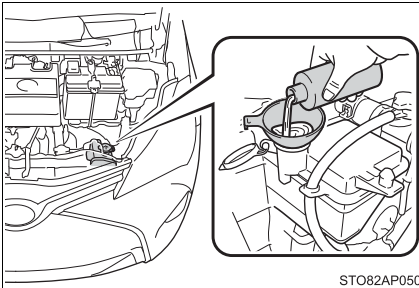

► Diesel engine

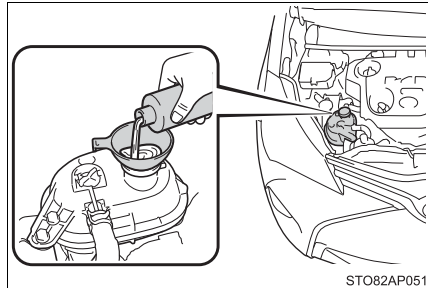

- 6 Start the engine and turn the air conditioning system on to check that the radiator cooling fan operates and to check for coolant leaks from the radiator or hoses.

The fan operates when the air conditioning system is turned on immediately after a cold start. Confirm that the fan is operating by checking the fan sound and air flow. If it is difficult to check these, turn the air conditioning system on and off repeatedly.

(The fan may not operate in freezing temperatures.)

- 7 If the fan is not operating:
Stop the engine immediately and contact any authorized Toyota dealer or repairer, or another duly qualified and equipped professional.

If the fan is operating:

Have the vehicle inspected at the nearest authorized Toyota dealer or repairer, or another duly qualified and equipped professional.

 **WARNING****■ To prevent an accident or injury when inspecting under the hood of your vehicle**

Observe the following precautions.

Failure to do so may result in serious injury such as burns.

- If steam is seen coming from under the hood, do not open the hood until the steam has subsided. The engine compartment may be very hot.
- Keep hands and clothing (especially a tie, a scarf or a muffler) away from the fan and belts while the engine is operating.
- Do not loosen the radiator cap or the coolant reservoir cap while the engine and radiator are hot.

 **NOTICE****■ When adding engine coolant**

Add coolant slowly after the engine has cooled down sufficiently. Adding cool coolant to a hot engine too quickly can cause damage to the engine.

■ To prevent damage to the cooling system

Observe the following precautions.

- Avoid contaminating the coolant with foreign matter (such as sand or dust etc.).
- Do not use any coolant additives.

If you run out of fuel and the engine stalls (diesel engine only)

If you run out of fuel and the engine stalls

- 1 Refuel your vehicle.
- 2 Pull the rubber strip on the edge to unhook it from the cover, and then push the tabs in and lift the cover off.

► Left-hand drive vehicles

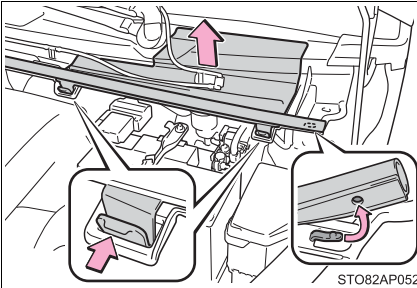

► Right-hand drive vehicles

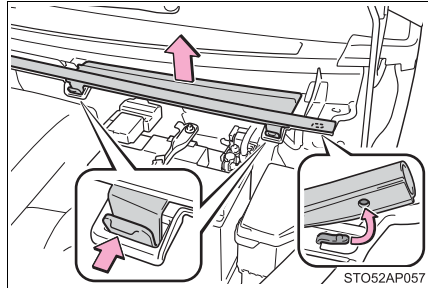

- 3 To bleed the fuel system, operate the priming pump until you feel more resistance.

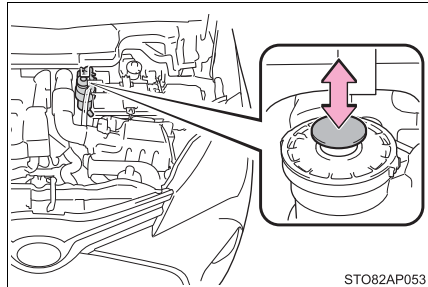

- 4 Reinstall the cover, and then hook the rubber strip's groove onto the cover.

▶ Left-hand drive vehicles

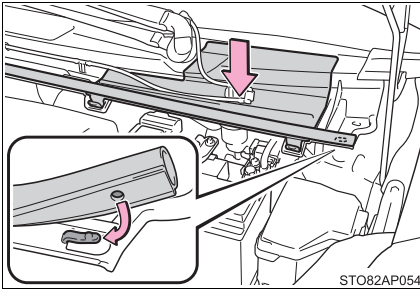

▶ Right-hand drive vehicles

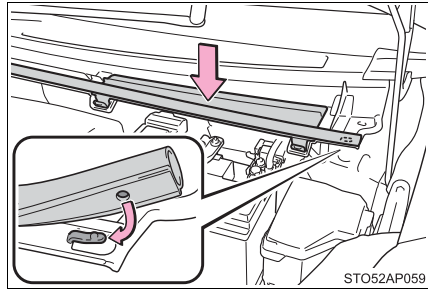

- 5 Start the engine. (→P. 182, 185)

If the engine does not start after the above steps have been performed, wait for 10 seconds and then try steps 3 and 5 again. If the engine still does not start, contact any authorized Toyota dealer or repairer, or another duly qualified and equipped professional.

After starting the engine, depress the accelerator pedal lightly until the engine runs smoothly.

 NOTICE

■ **When restarting the engine**

- Do not crank the engine before refueling and operating the priming pump. This may damage the engine and fuel system.
- Vehicles without a smart entry & start system: Do not crank the engine for more than 30 seconds at a time. This may overheat the starter and wiring system.

If the vehicle becomes stuck

Carry out the following procedures if the tires spin or the vehicle becomes stuck in mud, dirt or snow:

- 1 Stop the engine. Set the parking brake and shift the shift lever to P (Multidrive) or N (manual transmission).
- 2 Remove the mud, snow or sand from around the front wheels.
- 3 Place wood, stones or some other material under the front wheels to help provide traction.
- 4 Restart the engine.
- 5 Shift the shift lever to D or R (Multidrive) or 1 or R (manual transmission) and release the parking brake. Then, while exercising caution, depress the accelerator pedal.

■ When it is difficult to free the vehicle

Press the switch to turn off TRC.

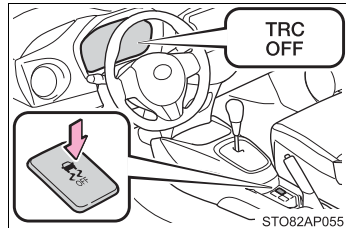

■ Emergency hooks

When your vehicle becomes stuck and cannot move, the emergency hooks are used for another vehicle to pull your vehicle out in an emergency.

Your vehicle is not designed to tow another vehicle.

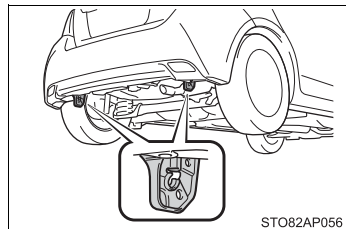

 **WARNING****■ When attempting to free a stuck vehicle**

If you choose to push the vehicle back and forth to free it, make sure the surrounding area is clear to avoid striking other vehicles, objects or people. The vehicle may also lunge forward or lunge back suddenly as it becomes free. Use extreme caution.

■ When shifting the shift lever

Be careful not to shift the shift lever with the accelerator pedal depressed. This may lead to unexpected rapid acceleration of the vehicle that may cause an accident resulting in death or serious injury.

 **NOTICE****■ To avoid damage to the transmission and other components**

- Avoid spinning the front wheels and depressing the accelerator pedal more than necessary.
- If the vehicle remains stuck even after these procedures are performed, the vehicle may require towing to be freed.

Vehicle specifications

9

9-1. Specifications

Maintenance data (fuel, oil level, etc.).....	468
Fuel information	487

9-2. Customization

Customizable features	489
-----------------------------	-----

9-3. Items to initialize

Items to initialize	493
---------------------------	-----

Maintenance data (fuel, oil level, etc.)

Dimensions and weights

Overall length		3950 mm (155.5 in.)
Overall width		1695 mm (66.7 in.)
Overall height* ¹		1510 mm (59.4 in.) 1520 mm (59.8 in.)* ² 1530 mm (60.2 in.)* ³
Wheelbase		2510 mm (98.8 in.)
Tread	Front	1485 mm (58.5 in.)* ⁴ 1470 mm (57.9 in.)* ⁵ 1460 mm (57.5 in.)* ⁶
	Rear	1470 mm (57.9 in.)* ⁴ 1460 mm (57.5 in.)* ⁵ 1445 mm (56.9 in.)* ⁶
Gross vehicle mass	1KR-FE engine	1450 kg (3197 lb.)
	1NR-FE engine	► Multidrive 1500 kg (3307 lb.) ► Manual transmission 1490 kg (3285 lb.)
	1ND-TV engine	1545 kg (3406 lb.)
Maximum permissible axle capacity	Front	► 1KR-FE engine 825 kg (1819 lb.) ► 1NR-FE engine 850 kg (1874 lb.) ► 1ND-TV engine 895 kg (1973 lb.)
	Rear	825 kg (1819 lb.)
Drawbar load		50 kg (110 lb.)

Towing capacity	with brake	<ul style="list-style-type: none"> ▶ 1KR-FE engine 730 kg (1609 lb.) ▶ 1NR-FE engine 880 kg (1940 lb.) ▶ 1ND-TV engine 780 kg (1719 lb.)
	without brake	550 kg (1212 lb.)
Maximum permissible mass for towing hitch/bracket*7		19 kg (41 lb.)

*1: Unladen vehicles

*2: Vehicles with rough road package (without raised vehicle height)

*3: Vehicles with rough road package (with raised vehicle height)

*4: 175/65R14, 175/70R14 or 175/65R15 tires

*5: 185/60R15 tires

*6: 195/50R16 tires

*7: Vehicle category N1 models

Vehicle identification

■ Vehicle identification number

The vehicle identification number (VIN) is the legal identifier for your vehicle. This is the primary identification number for your Toyota. It is used in registering the ownership of your vehicle.

This number is stamped under the front right seat.

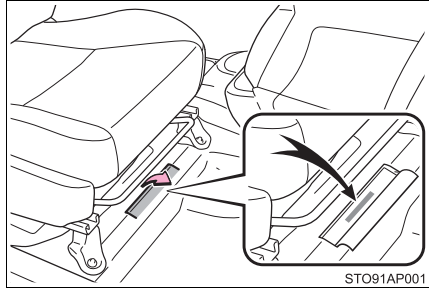

This number is also on the manufacturer's label on the left-hand side of the center pillar.

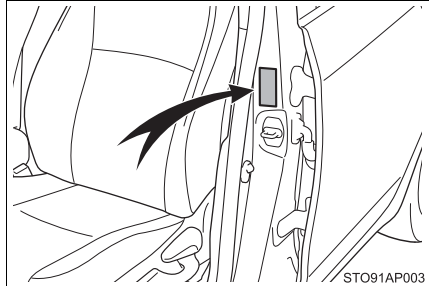

■ Engine number

The engine number is stamped on the engine block as shown.

▶ 1KR-FE engine

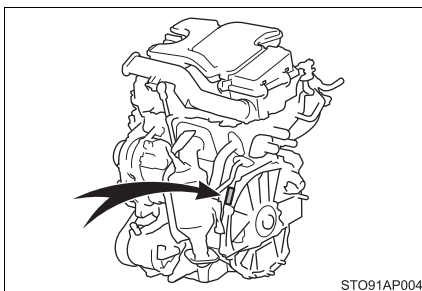

▶ 1NR-FE engine

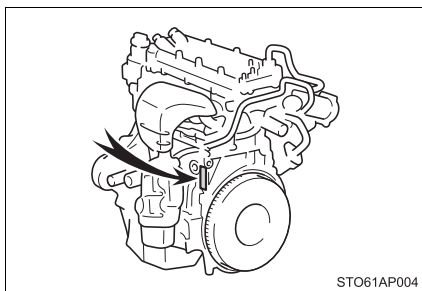

▶ 1ND-TV engine

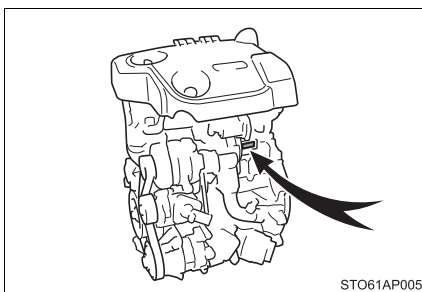

Engine

■ Gasoline engine

▶ 1KR-FE engine

Model	1KR-FE
Type	3-cylinder in line, 4-cycle, gasoline
Bore and stroke	71.0 × 84.0 mm (2.79 × 3.30 in.)
Displacement	998 cm ³ (60.9 cu.in.)
Valve clearance (engine cold)	Intake: 0.145 — 0.235 mm (0.006 — 0.009 in.) Exhaust: 0.275 — 0.365 mm (0.011 — 0.014 in.)
Drive belt tension	Automatic adjustment

▶ 1NR-FE engine

Model	1NR-FE
Type	4-cylinder in line, 4-cycle, gasoline
Bore and stroke	72.5 × 80.5 mm (2.85 × 3.17 in.)
Displacement	1329 cm ³ (81.1 cu.in.)
Valve clearance (engine cold)	Automatic adjustment
Drive belt tension	Automatic adjustment

■ Diesel engine

▶ 1ND-TV engine

Model	1ND-TV
Type	4-cylinder in line, 4-cycle, diesel
Bore and stroke	73.0 × 81.5 mm (2.87 × 3.21 in.)
Displacement	1364 cm ³ (83.2 cu.in.)
Valve clearance (engine cold)	Intake: 0.11 — 0.17 mm (0.004 — 0.007 in.) Exhaust: 0.14 — 0.20 mm (0.006 — 0.008 in.)
Drive belt tension	Automatic adjustment



NOTICE

■ Drive belt type (diesel engine)

The high strength drive belt is used for the generator side drive belt. When replacing the drive belt, use Toyota genuine drive belt or equivalent high strength drive belt. If the high strength drive belt is not used, durability of the belt may become less than expected. The high strength drive belt is a belt with Aramid core which has higher strength compared to usually available belts with PET or PEN core.

Fuel

■ Gasoline engine

Fuel type	EU area: Unleaded gasoline conforming to European standard EN228 only Except EU area: Unleaded gasoline only
Research Octane Number	95 or higher
Fuel tank capacity (Reference)	42 L (11.1 gal., 9.2 Imp.gal.)

■ Diesel engine

Fuel type	EU area: Diesel fuel conforming to European standard EN590 Except EU area: Diesel fuel that contains 50 ppm or less of sulfur
Cetane number	48 or higher
Fuel tank capacity (Reference)	42 L (11.1 gal., 9.2 Imp.gal.)

Lubrication system (gasoline engine)

■ Oil capacity (Drain and refill — reference*)

With filter	<ul style="list-style-type: none"> ▶ 1KR-FE engine 2.8 L (3.0 qt., 2.5 Imp.qt.) ▶ 1NR-FE engine 3.4 L (3.6 qt., 3.0 Imp.qt.)
Without filter	<ul style="list-style-type: none"> ▶ 1KR-FE engine 2.6 L (2.7 qt., 2.3 Imp.qt.) ▶ 1NR-FE engine 3.2 L (3.4 qt., 2.8 Imp.qt.)

*: The engine oil capacity is a reference quantity to be used when changing the engine oil. Warm up and turn off the engine, wait more than 5 minutes, and check the oil level on the dipstick.

■ Engine oil selection

“Toyota Genuine Motor Oil” is used in your Toyota vehicle. Toyota recommends the use of approved “Toyota Genuine Motor Oil”. Another motor oil of matching quality can also be used.

Oil grade:

0W-20, 5W-20, 5W-30 and 10W-30:

API grade SL “Energy-Conserving”, SM “Energy-Conserving” or SN “Resource-Conserving”; or ILSAC multigrade engine oil

15W-40 and 20W-50:

API grade SL, SM or SN multigrade engine oil

Recommended viscosity (SAE):

SAE 0W-20 is filled into your Toyota vehicle at manufacturing, and the best choice for good fuel economy and good starting in cold weather.

If SAE 0W-20 oil is not available, SAE 5W-30 oil may be used. However, it should be replaced with SAE 0W-20 at the next oil change.

If you use SAE 10W-30 or a higher viscosity engine oil in extremely low temperatures, the engine may become difficult to start, so SAE 0W-20, 5W-20 or 5W-30 engine oil is recommended.

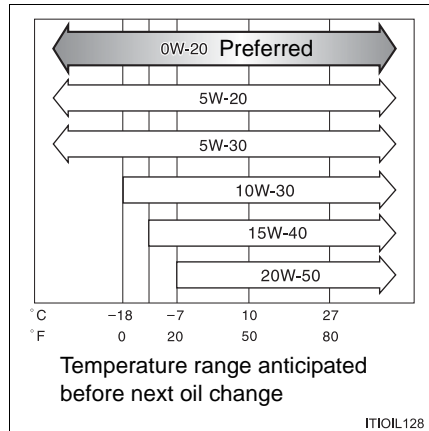

Oil viscosity (0W-20 is explained here as an example):

- The 0W in 0W-20 indicates the characteristic of the oil which allows cold startability. Oils with a lower value before the W allow for easier starting of the engine in cold weather.
- The 20 in 0W-20 indicates the viscosity characteristic of the oil when the oil is at high temperature. An oil with a higher viscosity (one with a higher value) may be better suited if the vehicle is operated at high speeds, or under extreme load conditions.

How to read oil container labels:

Either or both API registered marks are added to some oil containers to help you select the oil you should use.

① API Service Symbol

Top portion: "API SERVICE SN" means the oil quality designation by American Petroleum Institute (API).

Center portion: "SAE 0W-20" means the SAE viscosity grade.

Lower portion: "Resource-Conserving" means that the oil has fuel-saving and environmental protection capabilities.

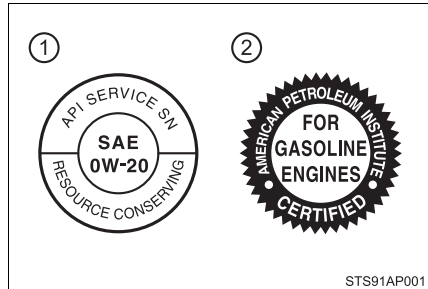

② ILSAC Certification Mark

The International Lubricant Specification Advisory Committee (ILSAC) Certification Mark is displayed on the front of the container.

Lubrication system (diesel engine)

■ Oil capacity (Drain and refill — reference*)

With filter	3.9 L (4.1 qt., 3.4 Imp.qt.)
Without filter	3.5 L (3.7 qt., 3.1 Imp.qt.)

*: The engine oil capacity is a reference quantity to be used when changing the engine oil. Warm up and turn off the engine, wait more than 5 minutes, and check the oil level on the dipstick.

■ Engine oil selection

▶ Vehicles without a DPF system*

“Toyota Genuine Motor Oil” is used in your Toyota vehicle. Toyota recommends the use of approved “Toyota Genuine Motor Oil”. Another motor oil of matching quality can also be used.

Oil grade: ACEA C2, B1, API CF-4 or CF

Recommended viscosity (SAE):

SAE 0W-30 is filled into your Toyota vehicle at manufacturing, and the best choice for good fuel economy and good starting in cold weather.

If you use SAE 10W-30 or a higher viscosity engine oil in extremely low temperatures, the engine may become difficult to start, so SAE 5W-30 or 0W-30 engine oil is recommended.

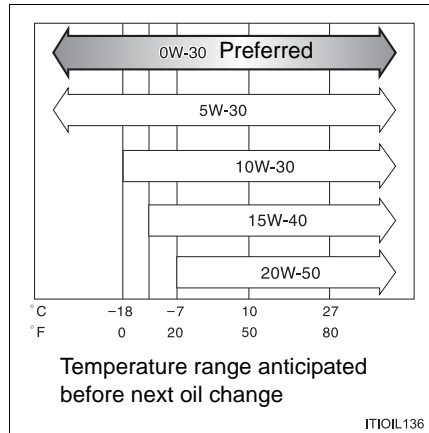

Oil viscosity (0W-30 is explained here as an example):

- The 0W in 0W-30 indicates the characteristic of the oil which allows cold startability. Oils with a lower value before the W allow for easier starting of the engine in cold weather.
- The 30 in 0W-30 indicates the viscosity characteristic of the oil when the oil is at high temperature. An oil with a higher viscosity (one with a higher value) may be better suited if the vehicle is operated at high speeds, or under extreme load conditions.

*: To determine whether or not your vehicle has a DPF system, contact any authorized Toyota dealer or repairer, or another duly qualified and equipped professional.

► Vehicles with a DPF system*

“Toyota Genuine Motor Oil” is used in your Toyota vehicle. Toyota recommends the use of approved “Toyota Genuine Motor Oil”. Another motor oil of matching quality can also be used.

Oil grade: ACEA C2



NOTICE

Using engine oil other than ACEA C2 may damage the catalytic converter.

Recommended viscosity (SAE):

SAE 0W-30 is filled into your Toyota vehicle at manufacturing, and the best choice for good fuel economy and good starting in cold weather.

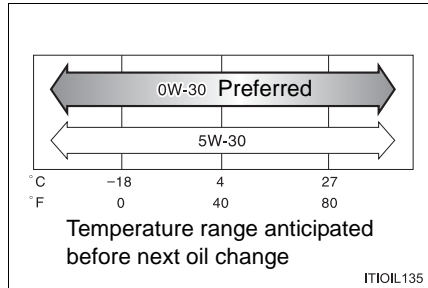

Oil viscosity (0W-30 is explained here as an example):

- The 0W in 0W-30 indicates the characteristic of the oil which allows cold startability. Oils with a lower value before the W allow for easier starting of the engine in cold weather.
- The 30 in 0W-30 indicates the viscosity characteristic of the oil when the oil is at high temperature. An oil with a higher viscosity (one with a higher value) may be better suited if the vehicle is operated at high speeds, or under extreme load conditions.

*: To determine whether or not your vehicle has a DPF system, contact any authorized Toyota dealer or repairer, or another duly qualified and equipped professional.

Cooling system

■ Gasoline engine

Capacity (Reference)	1KR-FE engine	4.5 L (4.8 qt., 4.0 Imp.qt.)
	1NR-FE engine	<ul style="list-style-type: none"> ▶ Multidrive 4.8 L (5.1 qt., 4.2 Imp.qt.) ▶ Manual transmission 4.6 L (4.9 qt., 4.0 Imp.qt.)
Coolant type		<p>Use either of the following:</p> <ul style="list-style-type: none"> • “Toyota Super Long Life Coolant” • A similar high-quality ethylene glycol-based non-silicate, non-amine, non-nitrite, and non-borate coolant with long-life hybrid organic acid technology <p>Do not use plain water alone.</p>

■ Diesel engine

Capacity (Reference)	<ul style="list-style-type: none"> ▶ Without a power heater 4.5 L (4.8 qt., 4.0 Imp.qt.) ▶ With a power heater 4.9 L (5.2 qt., 4.3 Imp.qt.)
Coolant type	<p>Use either of the following:</p> <ul style="list-style-type: none"> • “Toyota Super Long Life Coolant” • A similar high-quality ethylene glycol-based non-silicate, non-amine, non-nitrite, and non-borate coolant with long-life hybrid organic acid technology <p>Do not use plain water alone.</p>

Ignition system (gasoline engine only)

Spark plug	
Make	▶ 1KR-FE engine DENSO SC16HR11 ▶ 1NR-FE engine DENSO SC20HR11
Gap	1.1 mm (0.043 in.)



NOTICE

■ Iridium-tipped spark plugs

Use only iridium-tipped spark plugs. Do not adjust the spark plug gap.

Electrical system

Battery	
Open voltage* at 20°C (68°F):	12.6 — 12.8 V Fully charged 12.2 — 12.4 V Half charged 11.8 — 12.0 V Discharged (*: Voltage is checked 20 minutes after the engine and all lights are turned off.)
Charging rates	5 A max.

Multidrive

Fluid capacity*	6.4 L (6.8 qt., 5.6 Imp.qt.)
Fluid type	Toyota Genuine CVT Fluid FE

*: The fluid capacity is the reference quantity. If replacement is necessary, contact any authorized Toyota dealer or repairer, or another duly qualified and equipped professional.

 NOTICE

■ **Multidrive fluid type**

Using Multidrive fluid other than “Toyota Genuine CVT Fluid FE” may cause deterioration in shift quality, locking up of your transmission accompanied by vibration, and ultimately damage the transmission of your vehicle.

Manual transmission

Gear oil capacity (Reference)	<ul style="list-style-type: none"> ▶ 1KR-FE engine 1.7 L (1.8 qt., 1.5 Imp.qt.) ▶ 1NR-FE and 1ND-TV engines 2.4 L (2.5 qt., 2.1 Imp.qt.)
Gear oil type	Use either of the following: <ul style="list-style-type: none"> • “TOYOTA Genuine Manual Transmission Gear Oil LV” • Other gear oil that meets API GL-4 and SAE 75W specifications

 NOTICE

■ **Manual transmission gear oil**

Please be aware that depending on the particular characteristics of the gear oil used or the operating conditions, idle sound, shift feeling and/or fuel efficiency may be different or affected. Toyota recommends to use “TOYOTA Genuine Manual Transmission Gear Oil LV” to achieve optimal performance.

Clutch

Pedal free play	5 — 15 mm (0.2 — 0.6 in.)
Fluid type	SAE J1704 or FMVSS No. 116 DOT 4

Brakes

Pedal clearance* ¹	Left-hand drive vehicles	Gasoline engines	<ul style="list-style-type: none"> ▶ Rear drum brake 83 mm (3.27 in.) Min. ▶ Rear disk brake 79 mm (3.11 in.) Min.
		Diesel engines	<ul style="list-style-type: none"> ▶ Rear drum brake 81 mm (3.19 in.) Min. ▶ Rear disk brake 78 mm (3.07 in.) Min.
	Right-hand drive vehicles	Gasoline engines	<ul style="list-style-type: none"> ▶ Rear drum brake 76 mm (2.99 in.) Min. ▶ Rear disk brake 74 mm (2.91 in.) Min.
		Diesel engines	<ul style="list-style-type: none"> ▶ Rear drum brake 75 mm (2.95 in.) Min. ▶ Rear disk brake 73 mm (2.87 in.) Min.
Pedal free play		1 — 6 mm (0.04 — 0.24 in.)	
Parking brake lever travel* ²		<ul style="list-style-type: none"> ▶ Rear drum brake 5 — 7 clicks ▶ Rear disc brake 4 — 6 clicks 	
Fluid type		SAE J1704 or FMVSS No.116 DOT 4	

*1: Minimum pedal clearance when depressed with a force of 300 N (31.0 kgf, 67.4 lbf) while the engine is running

*2: Parking brake lever travel when pulled up with a force of 200 N (20.4 kgf, 45.0 lbf)

Steering

Free play	Less than 30 mm (1.2 in.)
-----------	---------------------------

Tires and wheels

► 14-inch tires (Type A)

Tire size	175/65R14 82T
Tire inflation pressure (Recommended cold tire inflation pressure)	220 kPa (2.2 kgf/cm ² or bar, 32 psi)
Wheel size	14 × 5J
Wheel nut torque	103 N·m (10.5 kgf·m, 76 ft·lbf)

► 14-inch tires (Type B)

Tire size	175/70R14 84S	
Tire inflation pressure (Recommended cold tire inflation pressure)	Front wheel kPa (kgf/cm ² or bar, psi)	Rear wheel kPa (kgf/cm ² or bar, psi)
	250 (2.5, 36)	240 (2.4, 35)
Wheel size	14 × 5J	
Wheel nut torque	103 N·m (10.5 kgf·m, 76 ft·lbf)	

► 15-inch tires (Type A)

Tire size	175/65R15 84H	
Tire inflation pressure (Recommended cold tire inflation pressure)	Front wheel kPa (kgf/cm ² or bar, psi)	Rear wheel kPa (kgf/cm ² or bar, psi)
	Standard tire pressure: 230 (2.3, 33) ECO tire pressure*: 250 (2.5, 36)	Standard tire pressure: 220 (2.2, 32) ECO tire pressure*: 240 (2.4, 35)
Wheel size	15 × 5J	
Wheel nut torque	103 N·m (10.5 kgf·m, 76 ft·lbf)	

*: For some models, ECO tire pressure is shown on the tire pressure label.
(→P. 440)

“For optimizing fuel economy, ECO tire pressure is recommended.

Tire pressure affects traveling comfort, road noise and steering characteristics.”

► 15-inch tires (Type B)

Tire size	185/60R15 84H		
Tire inflation pressure (Recommended cold tire inflation pressure)	Vehicle speed	Front wheel kPa (kgf/cm ² or bar, psi)	Rear wheel kPa (kgf/cm ² or bar, psi)
	160 km/h (99 mph) or less	220 (2.2, 32)	220 (2.2, 32)
	More than 160 km/h (99 mph)	240 (2.4, 35)	220 (2.2, 32)
Wheel size	15 × 5 1/2J		
Wheel nut torque	103 N·m (10.5 kgf·m, 76 ft·lbf)		

► 16-inch tires

Tire size	195/50R16 84V		
Tire inflation pressure (Recommended cold tire inflation pressure)	Vehicle speed	Front wheel kPa (kgf/cm ² or bar, psi)	Rear wheel kPa (kgf/cm ² or bar, psi)
	160 km/h (99 mph) or less	220 (2.2, 32)	200 (2.0, 29)
	More than 160 km/h (99 mph)	240 (2.4, 35)	210 (2.1, 30)
Wheel size	16 × 6J		
Wheel nut torque	103 N·m (10.5 kgf·m, 76 ft·lbf)		

► Compact spare tires

Tire size	T125/70D15 95M
Tire inflation pressure (Recommended cold tire inflation pressure)	420 kPa (4.2 kgf/cm ² or bar, 60 psi)
Wheel size	15 × 4T
Wheel nut torque	103 N·m (10.5 kgf·m, 76 ft·lbf)

Tire size	T125/70D16 96M
Tire inflation pressure (Recommended cold tire inflation pressure)	420 kPa (4.2 kgf/cm ² or bar, 60 psi)
Wheel size	16 × 4T
Wheel nut torque	103 N·m (10.5 kgf·m, 76 ft·lbf)

■ When towing a trailer

Add 20.0 kPa (0.2 kgf/cm² or bar, 3 psi) to the recommended tire inflation pressure, and drive at speeds below 100 km/h (62 mph).

Light bulbs

	Light Bulbs	W	Type
Exterior	Halogen headlights Reflector type Projector type	60/55 55	A B
	Front fog lights*	19	C
	Front position light/daytime running lights (bulb type)	21/5	D
	Front turn signal lights	21	E
	Side turn signal lights	5	E
	Rear turn signal lights	21	G
	Stop/tail lights (bulb type)	21/5	D
	Back-up light	21	D
	Rear fog light	21	D
	License plate lights	5	D
Interior	Vanity lights*	5	F
	Personal lights/interior light	5	D
	Luggage compartment light	5	F

A: H4 halogen bulbs

B: HIR2 halogen bulbs

C: H16 halogen bulbs

D: Wedge base bulbs (clear)

E: Wedge base bulbs (amber)

F: Double end bulbs

G: Single end bulbs (clear)

*: If equipped

Fuel information

▶ Gasoline engine

EU area:

Your vehicle must use only unleaded gasoline conforming to European standard EN228.

For optimum engine performance, select unleaded gasoline with a Research Octane Number of 95 or higher.

Except EU area:

Your vehicle must use only unleaded gasoline.

For optimum engine performance, select unleaded gasoline with a Research Octane Number of 95 or higher.

▶ Diesel engine

EU area:

Your vehicle must use only diesel fuel conforming to European standard EN590.

Except EU area:

Your vehicle must use only diesel fuel that contains 50 ppm or less of sulfur and has a cetane number of 48 or higher.

■ Fuel tank opening for unleaded gasoline (gasoline engine)

To help prevent incorrect fueling, your vehicle has a fuel tank opening that only accommodates the special nozzle on unleaded fuel pumps.

■ If you plan to drive in foreign countries (diesel engine)

Low sulfur diesel fuel may not be available, so please check the availability with your distributor.

■ If your engine knocks

- Consult any authorized Toyota dealer or repairer, or another duly qualified and equipped professional.
- You may occasionally notice light knocking for a short time while accelerating or driving uphill. This is normal and there is no need for concern.

 NOTICE**■ Notice on fuel quality (gasoline engine)**

- Do not use improper fuels. If improper fuels are used, the engine will be damaged.
- Do not use leaded gasoline.
Leaded gasoline will cause the three-way catalytic converter to lose its effectiveness and the emission control system to function improperly.
- EU area: Bioethanol fuel sold under names such as “E50” or “E85” and fuel containing a large amount of ethanol should not be used. The use of these fuels will damage the vehicle’s fuel system. In case of any doubt, ask any authorized Toyota dealer or repairer, or another duly qualified and equipped professional.
- Except EU area: Bioethanol fuel sold under names such as “E50” or “E85” and fuel containing a large amount of ethanol should not be used. Your vehicle can use gasoline mixed with 10% max ethanol. The use of fuel with more than 10% ethanol content (E10) will damage the vehicle’s fuel system. You must ensure that refueling is carried out only from a source where fuel specification and quality can be guaranteed. In case of any doubt, ask any authorized Toyota dealer or repairer, or another duly qualified and equipped professional.

■ Notice on fuel quality (diesel engine)

- Do not use improper fuels. If improper fuels are used, the engine will be damaged.
- Do not use a fuel that contains more than 50 ppm of sulfur.
Use of such a high sulfur fuel may damage the engine.
- EU area: FAME (Fatty Acid Methyl Ester) fuel sold under names such as “B30” or “B100” and fuel containing a large amount of FAME should not be used. The use of these fuels will damage the vehicle’s fuel system. In case of any doubt, ask any authorized Toyota dealer or repairer, or another duly qualified and equipped professional.
- Except EU area: FAME (Fatty Acid Methyl Ester) fuel sold under names such as “B30” or “B100” and fuel containing a large amount of FAME should not be used. Your vehicle can use diesel mixed with 5% max bio-diesel FAME (B5). The use of fuel with more than 5% FAME content (B5) will damage the vehicle’s fuel system. You must ensure that refueling is carried out only from a source where fuel specification and quality can be guaranteed. In case of any doubt, ask any authorized Toyota dealer or repairer, or another duly qualified and equipped professional.

Customizable features

Your vehicle includes a variety of electronic features that can be personalized to suit your preferences. Programming these preferences requires specialized equipment and may be performed by any authorized Toyota dealer or repairer, or another duly qualified and equipped professional.

Customizable features

Some function settings are changed simultaneously with other functions being customized. Contact any authorized Toyota dealer or repairer, or another duly qualified and equipped professional for further details.

- ① Vehicles with a Navigation/Multimedia system: Settings that can be changed using the Navigation/Multimedia system
(For further information on customizing settings using the Navigation/Multimedia system, refer to the “Navigation and multimedia system Owner’s Manual”.)
- ② Settings that can be changed by any authorized Toyota dealer or repairer, or another duly qualified and equipped professional for further details

Definition of symbols: O = Available, — = Not available

■ Smart entry & start system (→P. 114, 127)

Function	Default setting	Customized setting	①	②
Smart entry & start system	ON	OFF	○	○
Operation signal (Emergency flashers)	ON	OFF	—	○
Time elapsed before automatic door lock function is activated if door is not opened after being unlocked	30 seconds	60 seconds	—	○
		120 seconds		
Open door warning function (when locking the vehicle)	ON	OFF	—	○

■ Wireless remote control (→P. 103, 115)

Function	Default setting	Customized setting	①	②
Wireless remote control	ON	OFF	—	○
Operation signal (Emergency flashers)	ON	OFF	—	○
Time elapsed before automatic door lock function is activated if door is not opened after being unlocked	30 seconds	60 seconds	—	○
		120 seconds		
Open door warning buzzer (When locking the vehicle)	ON	OFF	—	○

■ Automatic light control system (→P. 202)

Function	Default setting	Customized setting	①	②
Light sensor sensitivity	Level 3	Level 1 to 5	○	○

■ Lights (→P. 202)

Function	Default setting	Customized setting	①	②
Time that the low beam headlights are on when the vehicle is parked	30 seconds	60 seconds	—	○
		90 seconds		
		120 seconds		

■ Illumination (→P. 299)

Function	Default setting	Customized setting	①	②
Time elapsed before the interior lights turn off	15 seconds	7.5 seconds	—	○
		30 seconds		
Operation when the doors are unlocked	ON	OFF	—	○
Operation after the engine switch is turned off	ON	OFF	—	○
Operation when you approach the vehicle with the electronic key on your person*	ON	OFF	—	○

*: Vehicles with a smart entry & start system

**WARNING****■ During customization**

As the engine needs to be running during customization, ensure that the vehicle is parked in a place with adequate ventilation. In a closed area such as a garage, exhaust gases including harmful carbon monoxide (CO) may collect and enter the vehicle. This may lead to death or a serious health hazard.

**NOTICE****■ During customization**

To prevent battery discharge, ensure that the engine is running while customizing features.

Items to initialize

The following item must be initialized for normal system operation in cases such as after the battery is reconnected, or maintenance is performed on the vehicle.

Item	When to initialize	Reference
Engine oil maintenance data *1	After changing engine oil	P. 338
Tire pressure warning system *2	<ul style="list-style-type: none"> • When rotating the tires on vehicles with differing front and rear tire inflation pressures • When changing tire pressure (such as when changing traveling speed) • When changing the tire size 	P. 348

*1: Diesel engine only

*2: If equipped

Index

What to do if... (Troubleshooting)	496
Alphabetical index	500

For vehicles with a Navigation/Multimedia system, refer to the “Navigation and multimedia system Owner’s Manual” for information regarding the equipment listed below.

- Navigation/Multimedia system
- Rear view monitor system

What to do if... (Troubleshooting)

If you have a problem, check the following before contacting any authorized Toyota dealer or repairer, or another duly qualified and equipped professional.

The doors cannot be locked, unlocked, opened or closed



You lose your keys

- If you lose your keys, new genuine keys can be made by any authorized Toyota dealer or repairer, or another duly qualified and equipped professional. (→P. 104)
- If you lose your electronic keys, the risk of vehicle theft increases significantly. Contact any authorized Toyota dealer or repairer, or another duly qualified and equipped professional immediately. (→P. 113)



The doors cannot be locked or unlocked

- Is the key battery weak or depleted? (→P. 367)
- Vehicles with a smart entry & start system:
Is the engine switch in IGNITION ON mode?
When locking the doors, turn the engine switch off. (→P. 186)
- Vehicles with a smart entry & start system:
Is the electronic key left inside the vehicle?
When locking the doors, make sure that you have the electronic key on your person.
- The function may not operate properly due to the condition of the radio wave. (→P. 105, 130)



The rear door cannot be opened

- Is the child-protector lock set?
The rear door cannot be opened from inside the vehicle when the lock is set. Open the rear door from outside and then unlock the child-protector lock. (→P. 119)

If you think something is wrong



The engine does not start (vehicles without a smart entry & start system)

- Vehicles with a Multidrive:
Is the shift lever in P? (→P. 182)
- Vehicles with a manual transmission:
Did you turn the key while firmly depressing the clutch pedal? (→P. 182)
- Is the battery discharged? (→P. 453)



The engine does not start (vehicles with a smart entry & start system)

- Vehicles with a Multidrive:
Did you press the engine switch while firmly depressing the brake pedal?
(→P. 185)
- Vehicles with a manual transmission:
Did you press the engine switch while firmly depressing the clutch pedal?
(→P. 185)
- Vehicles with a Multidrive:
Is the shift lever in P? (→P. 185)
- Is the electronic key anywhere detectable inside the vehicle? (→P. 128)
- Is the steering wheel unlocked? (→P. 188)
- Is the electronic key battery weak or depleted?
In this case, the engine can be started in a temporary way. (→P. 451)
- Is the battery discharged? (→P. 453)



The shift lever cannot be shifted from P even if you depress the brake pedal (vehicles with a Multidrive)

- Vehicles without a smart entry & start system:
Is the engine switch in the "ON" position?
If you cannot release the shift lever by depressing the brake pedal with the engine switch in the "ON" position. (→P. 450)
- Vehicles with a smart entry & start system:
Is the engine switch in IGNITION ON mode?
If you cannot release the shift lever by depressing the brake pedal with the engine switch in IGNITION ON mode. (→P. 450)



The steering wheel cannot be turned after the engine is stopped

- Vehicles without a smart entry & start system:
It is locked to prevent theft of the vehicle if the key is pulled from the engine switch. (→P. 184)
- Vehicles with a smart entry & start system:
It is locked automatically to prevent theft of the vehicle. (→P. 188)



The windows do not open or close by operating the power window switches

- Is the window lock switch pressed?
The power window except for the one at the driver's seat cannot be operated if the window lock switch is pressed. (→P. 154)



The engine switch is turned off automatically (vehicles with a smart entry & start system)

- The auto power off function will be operated if the vehicle is left in ACCESSORY or IGNITION ON mode (the engine is not running) for a period of time. (→P. 187)



A warning buzzer sounds during driving

- The seat belt reminder light is flashing
Is the driver wearing the seat belts? (→P. 408)
- The parking brake indicator is on
Is the parking brake released? (→P. 405)

Depending on the situation, other types of warning buzzer may also sound. (→P. 405)



A warning light turns on

- When a warning light turns on, refer to P. 405.

When a problem has occurred



If you have a flat tire

- Stop the vehicle in a safe place and replace the flat tire with the spare tire. (→P. 418)



The vehicle becomes stuck

- Try the procedure for when the vehicle becomes stuck in mud, dirt, or snow. (→P. 464)

Alphabetical index

A

A/C..... 280, 287

Air conditioning filter..... 365

Automatic air conditioning

system 287

Manual air conditioning

system 280

ABS (Anti-lock Brake System) 235

Function 235

Warning light 406

Air conditioning filter 365**Air conditioning****system 280, 287**

Air conditioning filter..... 365

Automatic air conditioning

system 287

Manual air conditioning

system 280

Airbag manual on-off system ... 49**Airbags 37**

Airbag manual on-off

system 49

Airbag operating conditions 44

Airbag precautions for

your child 39

Airbag warning light 406

Correct driving posture..... 28

Curtain shield airbag

operating conditions 44

Curtain shield airbag

precautions 41

General airbag precautions..... 39

Locations of airbags..... 37

Modification and

disposal of airbags..... 43

Side airbag operating

conditions 44

Side airbag precautions 41

Side and curtain shield

airbags operating

conditions 44

Side and curtain shield

airbags precautions 41

SRS airbags..... 37

Alarm

Warning buzzer..... 405

Anchor brackets 67**Antenna**

Radio 256, 316

Smart entry &

smart system 127

Anti-lock Brake System**(ABS) 235**

Function 235

Warning light 406

Armrest..... 313**Ashtray 310****Assist grips 314****Audio system (with a navigation/ multimedia system)*****Audio system****(without a navigation/****multimedia system)..... 246**

CD player 257

iPod..... 266

MP3/WMA disc 257

Optimal use..... 250

Radio 252

Steering wheel audio

switch 248

USB memory 273

USB port 249

Automatic air conditioning system 287
 Air conditioning filter..... 365
 Automatic air conditioning system 287
Automatic light control system 205
Auxiliary boxes 308

B

Back door
 Back door..... 121
 Luggage compartment light..... 123
Back-up lights
 Replacing light bulb..... 389
 Wattage..... 486
Battery 342
 If the vehicle battery is discharged 453
 Preparing and checking before winter..... 242
 Warning light..... 405
Bottle holders..... 304
Brake
 Fluid 482
 Parking brake..... 201
 Warning light..... 405
Brake assist..... 235
Break-in tips 163
Brightness control
 Instrument panel light control..... 89

C

Care..... 316, 319
 Aluminum wheels..... 317
 Exterior 316
 Interior..... 319
 Seat belts 320
CD player 257
Chains..... 243
Child restraint system..... 53
 Baby seats definition..... 54
 Baby seats installation 64
 Child seats definition..... 54
 Child seats installation 64, 65
 Installing CRS with ISOFIX rigid anchors..... 67
 Installing CRS with seat belts 64
 Installing CRS with top strap... 68
 Junior seats definition 54
 Junior seats installation 66
Child safety 52
 Airbag precautions..... 39
 Back door precautions 124
 Battery precautions..... 343
 Child restraint system 53
 How your child should wear the seat belt..... 33
 Installing child restraints 63
 Power window lock switch 154
 Power window precautions ... 157
 Rear door child-protectors 119
 Removed key battery precautions..... 369
 Seat belt precautions 34
 Seat heater precaution 298

*: Refer to "Navigation and multimedia system Owner's manual".

Child-protectors	119
Cigarette lighter	311
Cleaning	316, 319
Aluminum wheels.....	317
Exterior.....	316
Interior.....	319
Seat belts.....	320
Clock	93
Clutch	481
Condenser	341
Coolant	340
Capacity.....	479
Checking.....	340
Preparing and checking	
before winter.....	242
Cooling system	340
Engine overheating.....	458
CRS (Child Restraint	
System)	53
Cruise control	220
Warning lights	407
Cup holders	303
Curtain shield airbags	37
Customizable features	489

D

Daytime running light	
system	205
Replacing light bulbs.....	390
Defogger	
Outside rear view	
mirrors	283, 291
Rear window	283, 291
Windshield	282, 291
Diesel Particular Filter	
system	240
Warning lights.....	409
Dimensions	468
Display	
Drive information.....	91
Multi-information display	90
Do-it-yourself maintenance	325
Door lock	
Back door.....	121
Side doors.....	114
Smart entry & start system ...	127
Wireless remote control.....	103
Doors	
Back door.....	121
Door glasses.....	154
Door lock.....	114, 121
Open door warning buzzer ...	128
Open door warning light.....	407
Outside rear view mirrors.....	151
Rear door child-protector	119
Side doors.....	114
Side windows.....	154
Double locking system	79
Driver's seat belt reminder	
light	408
Driving	160
Break-in tips.....	163
Correct driving posture	28
Procedures	160
Winter drive tips	242

E

Eco Driving Indicator Light.....	164
Electric Power Steering	
(EPS).....	235
Function	235
Warning light.....	406
Electronic key	102
Battery-saving function	129
If the electronic key does not operate properly	451
Replacing the battery	367
Emergency brake signal	235
Emergency flashers.....	394
Emergency, in case of	
If the electronic key does not operate properly	451
If the engine will not start	448
If the shift lever cannot be shifted from P	450
If the vehicle battery is discharged	453
If the warning buzzer sounds	405
If the warning light turns on.....	405
If you have a flat tire.....	418, 433
If you lose your keys	104
If you run out of fuel and the engine stalls.....	462
If you think something is wrong.....	403
If your vehicle becomes stuck	464
If your vehicle has to be stopped in an emergency ...	395
If your vehicle needs to be towed.....	397
If your vehicle overheats	458

Engine

“ACC” position	183
Accessory mode	186
Compartment.....	332
Engine switch.....	182, 185
Hood	328
How to start	
the engine.....	182, 185
Identification number	471
If the engine will not start	448
If you run out of fuel and the engine stalls	462
If your vehicle has to be stopped in an emergency ...	395
Ignition switch (engine switch)	182, 185
Overheating	458
Engine coolant.....	340
Capacity.....	479
Checking.....	340
Preparing and checking before winter.....	242
Engine coolant temperature warning light.....	406
Engine immobilizer system	74
Engine oil	335
Capacity.....	474
Checking.....	335
Preparing and checking before winter.....	242
Warning lights	410

Engine oil maintenance	
data	338
Engine switch	
(ignition switch)	182, 185
Engine switch light	
(ignition switch light)	299
EPS (Electric Power	
Steering)	235
Function	235
Warning light	406

F

Flat tire	418, 433
Floor mats	26
Fluid	
Brake	482
Clutch	481
Multidrive.....	480
Washer.....	345
Fog lights	208
Replacing light bulbs.....	381, 389
Switch	208
Wattage.....	486
Follow me home system	203
Front passenger's	
seat belt reminder light	408
Front position lights	202
Light switch	202
Replacing light bulbs.....	383
Wattage.....	486
Front seats	138
Adjustment	138
Cleaning.....	319
Correct driving posture.....	28
Head restraints.....	144
Seat heaters.....	297

Front turn signal lights	200
Replacing light bulbs.....	384
Turn signal lever	200
Wattage	486
Fuel	
Capacity	473
Fuel gauge.....	88
Fuel pump shut off system....	404
If you run out of fuel and	
the engine stalls	462
Information.....	487
Refueling.....	216
Type.....	216, 473
Warning light.....	408

Fuel consumption

Average fuel consumption	92
Instantaneous fuel	
consumption	92
Fuel filter	346, 407
Fuel filler door	216
Refueling.....	216
Fuel pump shut off system	404
Fuses	370

G

Gas station information	512
Gauges	88
Gear Shift Indicator	198
Glove box	302

H

Hands-free system (for cellular phone)*	
Hazard lights	
Switch	394
Head restraints.....	144
Headlights	202
Follow me home system	203
Light switch	202
Replacing light bulbs.....	378
Wattage.....	486
Heaters.....	280, 287
Automatic air conditioning system	287
Manual air conditioning system	280
Outside rear view mirrors	283, 291
Seat heaters.....	297
High mounted stoplight	
Replacing light bulbs.....	390
Hood.....	328
Open	328
Hooks	
Retaining hooks (floor mat).....	26
Horn	146

I

Identification	470
Engine.....	471
Vehicle	470
Ignition switch (engine switch)	182, 185
Ignition switch light (engine switch light)	299
Illuminated entry system	300
Immobilizer system	74
Indicators	85
Initialization	
Engine oil maintenance data	338
Items to initialize	493
Tire pressure warning system	348
Inside rear view mirror	148
Instrument panel light control	89
Intercooler	341
Interior lights.....	299
Switch	299
Wattage	486
ISOFIX rigid anchors	67

*: Refer to "Navigation and multimedia system Owner's manual".

J**Jack**

Positioning a floor jack 330

Vehicle-equipped jack 419

Jack handle 419, 434**Jam protection function**

Power window 155

K**Keyless entry**

Smart entry & start system 127

Wireless remote control 103

Keys 102

Battery-saving function 129

Electronic key 102

Engine switch 182, 185

If the electronic key does
not operate properly 451

If you lose your keys 104

Ignition switch 182, 185

Key number plate 102

Keyless entry 103

Mechanical key 104

Replacing the battery 367

Warning buzzer 128

Wireless remote control
key 103**L****Lever**

Auxiliary catch lever 328

Hood lock release lever 328

Shift lever 191, 196

Turn signal lever 200

Wiper lever 210, 214

License plate lights 202

Light switch 202

Replacing light bulbs 388

Wattage 486

Light bulbs

Replacing 376

Wattage 486

Lights

Engine switch light 299

Fog light switch 208

Follow me home system 203

Headlight switch 202

Ignition switch light 299

Illuminated entry system 300

Interior light 299

Interior lights list 299

Luggage compartment
light 123

Personal lights 300

Replacing light bulbs 376

Turn signal lever 200

Vanity lights 309

Wattage 486

Lock steering column 184, 188**Luggage cover 306**

M

Maintenance
 Do-it-yourself maintenance ... 325
 Maintenance data 468
 Maintenance requirements ... 322
Malfunction indicator lamp..... 406
Manual headlight leveling
 dial 204
Manual transmission 196
 Oil 481
Meter 88
 Indicators 85
 Instrument panel light
 control 89
 Meters 88
 Multi-information display 90
 Warning lights 83
Mirrors
 Inside rear view mirror 148
 Outside rear view mirror
 defoggers 283, 291
 Outside rear view mirrors 151
 Vanity mirrors 309
MP3 disc 257
Multidrive 191
 If the shift lever cannot be
 shifted from P 450
 Paddle shift switches 193, 194
Multi-information display 90
Multimedia system*

N

Navigation system*

O

Odometer..... 91
Oil
 Engine oil 474
 Manual transmission oil 481
Opener
 Back door 122
 Fuel filler door 218
 Hood 328
Outside rear view mirrors 151
 Adjusting and folding 151
 Outside rear view mirror
 defoggers 283, 291
Outside temperature
 display 94
Overheating..... 458

P

Paddle shift switches..... 193, 194
Parking brake..... 201
 Operation 201
 Parking brake engaged
 warning buzzer 405
Personal lights..... 300
 Switch 300
 Wattage 486
Portable ashtray 310
Power heater 295
Power outlet..... 312
Power steering..... 235
 Warning light 406
Power windows..... 154
 Jam protection function 155
 Operation 154
 Window lock switch 154

*: Refer to “Navigation and multimedia system Owner’s manual”.

R

Radiator	341
Radio	252
Radio data system	254
RDS	254
Rear fog light	208
Replacing light bulbs.....	389
Switch	208
Wattage.....	486
Rear passengers' seat belt reminder light	408
Rear seat	141
Folding down the rear seatbacks	141
Rear turn signal lights	200
Replacing light bulbs.....	386
Turn signal lever	200
Wattage.....	486
Rear view mirror	
Inside rear view mirror	148
Outside rear view mirrors.....	151
Rear view monitor*	
Rear window defogger	283, 291
Rear window wiper	214
Refueling	216
Capacity	473
Fuel types	216, 473
Opening the fuel tank cap	218
Replacing	
Electronic key battery.....	367
Fuses	370
Light bulbs.....	376
Tires.....	418, 433
Wireless remote control battery.....	367
Reset the maintenance data	338
Roof shade	313

S

Seat belt reminder light	408
Seat belts	30
Child restraint system installation	63
Cleaning and maintaining the seat belt.....	320
Emergency Locking Retractor (ELR)	33
How to wear your seat belt	30
How your child should wear the seat belt.....	33
Pregnant women, proper seat belt use	34
Reminder light and buzzer....	408
Seat belt pretensioners.....	33
SRS warning light	406
Seat heaters	297
Seats	138, 141
Adjustment.....	138
Adjustment precautions	140
Child seats/child restraint system installation.....	63
Cleaning.....	319
Folding down the rear seatbacks	141
Head restraints	144
Properly sitting in the seat	28
Seat heaters	297
Shift lever	191, 196
If the shift lever cannot be shifted from P	450
Manual transmission.....	196
Multidrive	191
Shift lock system	450

- Side airbags** 37
- Side doors** 114
- Side mirrors**..... 151
 - Adjusting and folding..... 151
 - Heaters 283, 291
- Side turn signal lights** 200
 - Replacing light bulbs..... 385
 - Turn signal lever 200
 - Wattage..... 486
- Smart entry & start system** 127
 - Antenna location 127
 - Entry functions 114, 121
 - Starting the engine..... 185
 - Warning lights 407
- Snow tires**..... 242
- Spare tire** 419
 - Inflation pressure 483
 - Storage location 419
- Spark plug** 480
- Specifications** 468
- Speed limiter** 224
 - Warning lights 407
- Speedometer** 88
- Steering lock** 184, 188
- Steering wheel** 146
 - Adjustment..... 146
 - Audio switches 248
- Stop & Start system**..... 228
 - Warning lights 407
- Stop lights**
 - Emergency brake signal 235
 - Replacing light bulbs..... 386, 390
 - Wattage..... 486
- Storage feature** 301
- Stuck**
 - If the vehicle becomes stuck 464
- Sun shade**
 - Roof 313
- Sun visors** 309
- Switches**
 - Audio remote control switches..... 248
 - Cruise control switch..... 220
 - Door lock switches..... 118
 - Emergency flashers switch ... 394
 - Engine switch..... 182, 185
 - Fog light switch 208
 - Hazard switch 394
 - Ignition switch 182, 185
 - Light switch 202
 - Outside rear view mirror switches..... 151
 - Paddle shift switches 193, 194
 - Power door lock switch 118
 - Power window switches 154
 - Rear window defogger switch 297
 - Rear window wiper and washer switch..... 214
 - Seat heater switches 297
 - “SPORT” button 192
 - Stop & Start cancel switch 229
 - Talk switch*
 - Telephone switch*
 - Tire pressure warning reset switch 349
 - VSC OFF switch 236
 - Window lock switch..... 154
 - Windshield wipers and washer switch..... 210

*: Refer to “Navigation and multimedia system Owner’s manual”.

T

Tachometer	88
Tail lights	202
Light switch	202
Replacing light bulbs.....	386, 390
Wattage.....	486
Talk switch*	
Telephone switch*	
Theft deterrent system	
Double locking system	79
Engine immobilizer system	74
Tire inflation pressure	360
Maintenance data	483
Warning light.....	408
Tire pressure warning system	348
Function	348
Initializing	348
Installing tire pressure warning valves and transmitters.....	348
Registering ID codes.....	350
Tire pressure warning reset switch.....	349
Warning light.....	408
Tires	347
Chains.....	243
Checking	347
If you have a flat tire.....	418, 433
Inflation pressure	483
Replacing.....	418, 433
Rotating tires.....	347
Size	483
Snow tires	242
Spare tire	418
Tire pressure warning reset switch.....	349
Warning light.....	408

Tools	419, 434
Top strap	68
Towing	
Emergency towing	397
Towing eyelet.....	399
Trailer towing	173
Traction control	235
Trailer towing	173
Transmission	191, 196
If the shift lever cannot be shifted from P	450
Manual transmission.....	196
Multidrive	191
Paddle shift switches	193, 194
Trip meters	91
Turn signal lights	200
Replacing light bulbs.....	384, 386
Turn signal lever	200
Wattage	486

U

USB memory*	273
USB port*	249

V

Vanity lights	309
Vanity lights	309
Wattage	486
Vanity mirrors	309
Vehicle identification number	470
Vehicle Stability Control (VSC)	235
VSC (Vehicle Stability Control)	235

W

Warning buzzers

Brake system	405
Electric power steering.....	406
Key reminder.....	184
Open door	407
Seat belt reminder.....	408
Smart entry & start system....	128

Warning lights..... 83

ABS.....	406
Brake system	405
Charging system	405
Cruise control indicator	407
Electric power steering system	406
Fuel filter	407
High engine coolant temperature	406
Low engine oil pressure	405
Low fuel level	408
Malfunction indicator lamp	406
Open door	407
Seat belt reminder light	408
Slip indicator	407
Smart entry & start system....	407
Speed limiter indicator	407
SRS.....	406
Stop & Start cancel indicator	407
Tire pressure.....	408

Washer..... 210, 214

Checking.....	345
Preparing and checking before winter.....	242
Switch	210, 214

Washing and waxing..... 316

Weight..... 468

Wheels..... 362

Replacing.....	362
Size.....	483

Window glasses..... 154

Window lock switch..... 154

Windows..... 154

Power windows.....	154
Rear window defogger	283, 291
Washer	210

Windshield wipers..... 210

Intermittent windshield wipers	210
Rain-sensing windshield wipers	211

Winter driving tips..... 242

Wireless remote control

key	103
Battery-saving function	129
Locking/Unlocking.....	103
Replacing the battery.....	367

WMA disc..... 257

*: Refer to "Navigation and multimedia system Owner's manual".

GAS STATION INFORMATION

Auxiliary catch lever

P. 328

Fuel filler door

P. 218

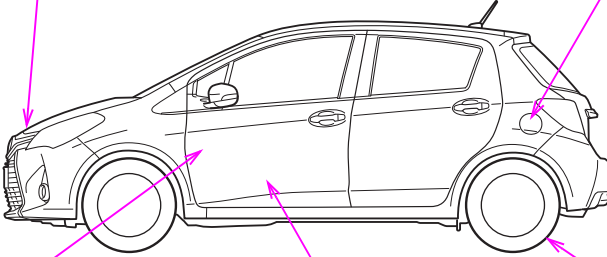

STOPIAP036

Hood lock release
lever

P. 328

Fuel filler door opener

P. 218

Tire inflation pressure

P. 483

Fuel tank capacity (Reference)	42 L (11.1 gal., 9.2 Imp.gal.)
Fuel type	P. 216, 473
Cold tire inflation pressure	P. 483
Engine oil capacity (Drain and refill — reference)	P. 474, 476
Engine oil type	P. 474, 476