

	Pictorial index	Search by illustration	
1	For safety and security	Make sure to read through them	
2	Instrument cluster	How to read the gauges and meters, the variety of warning lights and indicators, etc.	
3	Operation of each component	Opening and closing the doors and windows, adjustment before driving, etc.	
4	Driving	Operations and advices which are necessary for driving	
5	Audio system	Operating the audio system	
6	Interior features	Usage of the interior features, etc.	
7	Maintenance and care	Caring for your vehicle and maintenance procedures	
8	When trouble arises	What to do in case of malfunction or emergency	
9	Vehicle specifications	Vehicle specifications, customizable features, etc.	
	Index	Search by symptom	
		Search alphabetically	

For your information8
 Reading this manual..... 10
 How to search 11
 Pictorial index 12

1 For safety and security

1-1. For safe use
 Before driving.....32
 For safety drive34
 Seat belts36
 SRS airbags.....41
 Airbag manual on-off sys-
 tem.....54
 Safety information for chil-
 dren.....56
 Child restraint systems57
 Installing child restraints70
 Exhaust gas precautions81

1-2. Theft deterrent system
 Engine immobilizer sys-
 tem.....82
 Double locking system.....90
 Alarm91

2 Instrument cluster

2. Instrument cluster
 Warning lights and indica-
 tors.....98
 Gauges and meters105
 Multi-information display (Type
 A).....109
 Multi-information display(Type
 B).....114
 Fuel consumption informa-
 tion.....122

**3 Operation of each compo-
 nent**

3-1. Key information
 Keys 124

**3-2. Opening, closing and locking
 the doors**
 Side doors 130
 Back door 140
 Glass hatch 147
 Smart entry & start sys-
 tem.....153

3-3. Adjusting the seats
 Front seats 170
 Rear seats 173
 Driving position memory.... 188
 Head restraints..... 192

**3-4. Adjusting the steering wheel
 and mirrors**
 Steering wheel 195
 Inside rear view mirror..... 198
 Outside rear view mir-
 rors.....200

**3-5. Opening and closing the win-
 dows and moon roof**
 Power windows 203
 Moon roof 206

4 Driving

- 4-1. Before driving**
- Driving the vehicle212
 - Cargo and luggage224
 - Trailer towing227
- 4-2. Driving procedures**
- Engine (ignition) switch (vehicles without a smart entry & start system).....240
 - Engine (ignition) switch(vehicles with a smart entry & start system).....243
 - Automatic transmission.....251
 - Manual transmission.....258
 - Turn signal lever263
 - Parking brake.....264
 - Diesel Particulate Filter system (diesel engine only).....265
- 4-3. Operating the lights and wipers**
- Headlight switch.....267
 - Fog light switch277
 - Windshield wipers and washer.....279
 - Rear window wiper and washer.....285
 - Headlight cleaner switch....286
- 4-4. Refueling**
- Opening the fuel tank cap.....288
- 4-5. Using the driving support systems**
- Cruise control 292
 - Dynamic radar cruise control.....296
 - Toyota parking assist-sensor.....312
 - Rear view monitor system.....322
 - Toyota parking assist monitor.....333
 - Driving assist systems..... 360
 - BSM (Blind Spot Monitor) 366
 - The Blind Spot Monitor function.....375
 - The Rear Crossing Traffic Alert function.....375
 - PCS (Pre-Crash Safety system).....378
- 4-6. Driving tips**
- Winter driving tips..... 387

5 Audio system

5-1. Basic Operations
 Audio system types.....392
 Steering wheel audio switches.....393
 AUX port/USB port.....394

5-2. Using the audio system
 Optimal use of the audio system.....395

5-3. Using the radio
 Radio operation397

5-4. Playing an audio CD and MP3/WMA discs
 CD player operation.....401

5-5. Using an external device
 Listening to an iPod409
 Listening USB memory device.....416
 Using the AUX port423

5-6. Using Bluetooth® devices
 Bluetooth® audio/phone424
 Using the steering wheel switches.....429
 Registering a Bluetooth® device.....430

5-7. “SETUP” menu
 Using the “SETUP” menu(blue-tooth*menu).....431
 Using the “SETUP” menu (“TEL” menu).....435

5-8. Bluetooth® Audio
 Operating a Bluetooth® enables portable player.....439

5-9. Bluetooth® Phone
 Making a phone call 441
 Receiving a phone call 443
 Speaking on the phone 444

5-10. Bluetooth®
 Bluetooth® 446

6 Interior features

6-1. Using the air conditioning system and defogger
 Front manual air conditioning system.....452
 Front automatic air conditioning system.....458
 Rear manual air conditioning system.....467
 Rear automatic air conditioning system.....469
 Heated steering wheel/seat heaters.....472

6-2. Using the interior lights

- Interior lights list.....476
 - Personal/interior lights main switch.....477
 - Personal/interior lights ...477
 - Lounge illumination control switches.....478

6-3. Using the storage features

- List of storage features480
 - Glove box481
 - Card holder.....482
 - Console box482
 - Cup holders/bottle holders/door pockets.....484
 - Auxiliary boxes487

Luggage compartment features.....489

6-4. Using the other interior features

- Other interior features493
 - Cool box493
 - Sun visors.....495
 - Vanity mirror495
 - Conversation mirror496
 - Clock497
 - Power outlet498
 - Armrest.....501
 - Coat hooks501
 - Assist grips502
 - Ashtray503

7 Maintenance and care**7-1. Maintenance and care**

Cleaning and protecting the vehicle exterior.....506

Cleaning and protecting the vehicle interior.....510

7-2. Maintenance

Maintenance requirements.....513

1

2

3

4

5

6

7

8

9

7-3. Do-it-yourself maintenance

Do-it-yourself service (precautions).....	516
Hood	519
Engine compartment.....	520
Tires.....	539
Tire inflation pressure	552
Wheels.....	554
Air conditioning filter	557
Wireless remote (control/electronic (key battery)).....	559
Checking and replacing fuses.....	563
Light bulbs	567

8 When trouble arises**8-1. Essential information**

Emergency flashers	584
If your vehicle has to be stopped in an emergency.....	585

8-2. Steps to take in an emergency

If your vehicle needs to be towed.....	587
If you think something	
If you think something Fuel pump shut off system (gasoline engine only).....	593
If a warning light turns on or a warning (buzzer sounds).....	594
If a warning message is displayed.....	606
If you have a flat tire (vehicle with (a spare tire)).....	622
If you have a flat tire (vehicles without a spare tire)).....	641
If the engine will (not start).....	657
If the shift lever cannot be shifted from P (automatic (transmission)).....	659
If the electronic key does not operate properly(vehicles with a smart entry & (start system)).....	660
If the vehicle battery is discharged.....	663
If your vehicle overheats.....	669
If you run out of fuel (and the engine stalls(diesel engine only)).....	672
If the vehicle becomes stuck.....	673

9 Vehicle specifications

9-1. Specifications
Maintenance data ((fuel, oil level, etc.)).....676
Fuel information702

9-2. Customization
Customizable features705

9-3. Items to initialize
Items to initialize715

Index

What to do if... (Troubleshooting).....718
Alphabetical index722



For vehicles with a navigation system or a multimedia system, refer to the “Navigation system owner’s manual” for information regarding the equipment listed below.

- Navigation system
- Hands-free system (for cellular phone)
- Rear seat entertainment system
- Audio/video system

For your information

Main Owner's Manual

Please note that this manual applies to all models and explains all equipment, including options. Therefore, you may find some explanations for equipment not installed on your vehicle.

All specifications provided in this manual are current at the time of printing. However, because of the Toyota policy of continual product improvement, we reserve the right to make changes at any time without notice.

Depending on specifications, the vehicle shown in the illustrations may differ from your vehicle in terms of equipment.

Accessories, spare parts and modification of your Toyota

Both genuine Toyota and a wide variety of other spare parts and accessories for Toyota vehicles are currently available on the market. Should it be determined that any of the genuine Toyota parts or accessories supplied with the vehicle need to be replaced, Toyota recommends that genuine Toyota parts or accessories, be used to replace them. Other parts or accessories of matching quality can also be used. Toyota cannot accept any liability or guarantee spare parts and accessories which are not genuine Toyota products, nor for replacement or installation involving such parts. In addition, damage or performance problems resulting from the use of non-genuine Toyota spare parts or accessories may not be covered under warranty.

Installation of an RF-transmitter system

The installation of an RF-transmitter system in your vehicle could affect electronic systems such as:

- Multipoint fuel injection system/sequential multipoint fuel injection system
- Dynamic radar cruise control system
- Cruise control system
- Anti-lock brake system
- SRS airbag system
- Seat belt pretensioner system

Be sure to check with any authorized Toyota dealer or repairer, or another duly qualified and equipped professional for precautionary measures or special instructions regarding installation of an RF-transmitter system.

Further information regarding frequency bands, power levels, antenna positions and installation provisions for the installation of RF-transmitters, is available on request at any authorized Toyota dealer or repairer, or another duly qualified and equipped professional.

Scrapping of your Toyota

The SRS airbag and seat belt pretensioner devices in your Toyota contain explosive chemicals. If the vehicle is scrapped with the airbags and seat belt pretensioners left as they are, this may cause an accident such as fire. Be sure to have the systems of the SRS airbag and seat belt pretensioner removed and disposed of by a qualified service shop or by any authorized Toyota dealer or repairer, or another duly qualified and equipped professional before you scrap your vehicle.



Your vehicle contains batteries and/or accumulators. Do not discard them into the environment but cooperate with separate collection (Directive 2006/66/EC).

CAUTION

■ General precautions while driving

Driving under the influence: Never drive your vehicle when under the influence of alcohol or drugs that have impaired your ability to operate your vehicle. Alcohol and certain drugs delay reaction time, impair judgment and reduce coordination, which could lead to an accident that could result in death or serious injury.

Defensive driving: Always drive defensively. Anticipate mistakes that other drivers or pedestrians might make and be ready to avoid accidents.

Driver distraction: Always give your full attention to driving. Anything that distracts the driver, such as adjusting controls, talking on a cellular phone or reading can result in a collision with resulting death or serious injury to you, your occupants or others.

■ General precaution regarding children's safety

Never leave children unattended in the vehicle, and never allow children to have or use the key.

Children may be able to start the vehicle or shift the vehicle into neutral. There is also a danger that children may injure themselves by playing with the windows, the moon roof, or other features of the vehicle. In addition, heat build-up or extremely cold temperatures inside the vehicle can be fatal to children.

Reading this manual

 **CAUTION:**
Explains something that, if not obeyed, could cause death or serious injury to people.

 **NOTICE:**
Explains something that, if not obeyed, could cause damage to or a malfunction in the vehicle or its equipment.

... Indicates operating or working procedures. Follow the steps in numerical order.

 Indicates the action (pushing, turning, etc.) used to operate switches and other devices.

 Indicates the outcome of an operation (e.g. a lid opens).

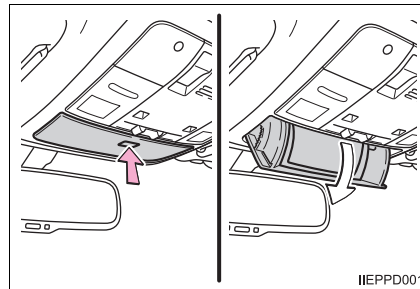

 Indicates the component or position being explained.

 Means "Do not", "Do not do this", or "Do not let this happen".

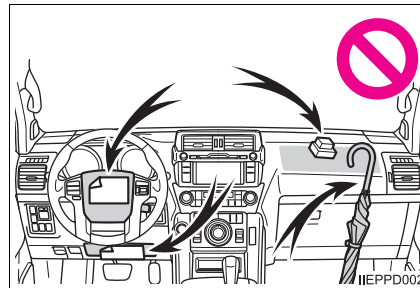

How to search

■ Searching by name

- Alphabetical index P. 722

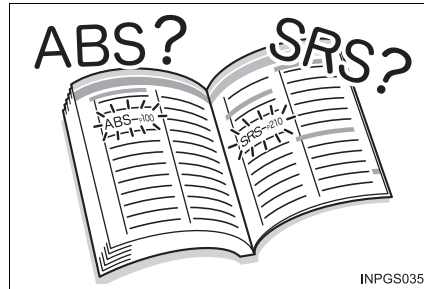

■ Searching by installation position

- Pictorial index P. 12

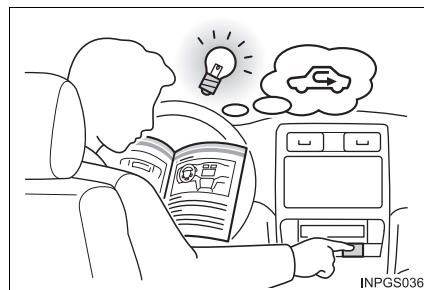

■ Searching by symptom or sound

- What to do if...
(Troubleshooting) P. 718



■ Searching by title

- Table of contents P. 3

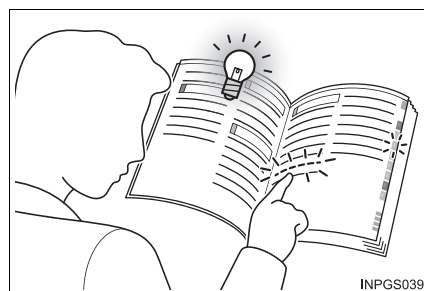

Pictorial index

■ Exterior

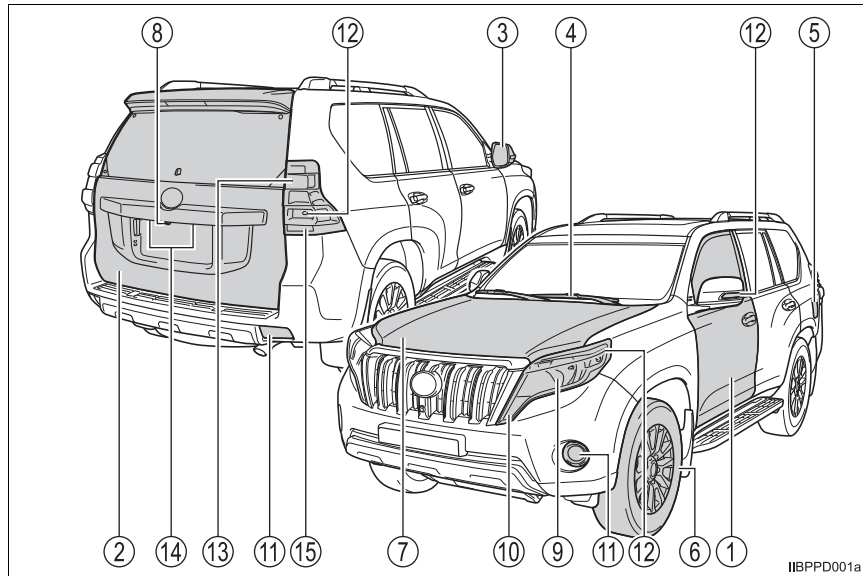

- ① **Side doors** **P. 130**
 - Locking/unlocking P. 130
 - Opening/closing the door glasses P. 203
 - Locking/unlocking by using the mechanical key*1 P. 660
 - Warning lights/warning messages*1 P. 597, 607
- ② **Back door** **P. 140**
 - Opening from outside P. 140
 - Opening/closing the glass hatch*1 P. 147
 - Warning lights/warning messages*1 P. 597, 607
- ③ **Outside rear view mirrors** **P. 200**
 - Adjusting the mirror angle P. 200
 - Folding the mirrors P. 201
 - Defogging the mirrors*1 P. 461

- ④ **Windshield wipers** **P. 279**
 Precautions against winter season P. 387
 To prevent freezing (windshield wiper de-icer)^{*1} P. 462
 Precautions against car wash P. 508
- ⑤ **Fuel filler door** **P. 288**
 Refueling method P. 288
 Fuel type/fuel tank capacity P. 682
- ⑥ **Tires** **P. 539**
 Tire size/inflation pressure P. 699
 Winter tires/tire chain P. 387
 Checking/rotation/tire pressure warning system^{*} P. 539
 Coping with flat tires P. 622
- ⑦ **Hood** **P. 519**
 Opening P. 519
 Engine oil P. 683
 Coping with overheat P. 669
- ⑧ **Camera^{*1, 2}** **P. 322, 333**

Light bulbs of the exterior lights for driving
 (Replacing method: P. 567, Watts: P. 701)

- ⑨ **Headlights/daytime running lights^{*1}** **P. 267**
- ⑩ **Front position lights/daytime running lights^{*1}** **P. 267**
- ⑪ **Front fog lights^{*1}/rear fog lights** **P. 277**
- ⑫ **Turn signal lights** **P. 263**
- ⑬ **Stop/tail lights** **P. 267**
 Hill-start assist control^{*1, 3}
 Downhill assist control system^{*1, 3}
- ⑭ **License plate lights^{*4}** **P. 267**
- ⑮ **Back-up lights**
 Shifting the shift lever to R. P. 251, 258

^{*1}: If equipped

^{*2}: The location of the camera differs depending on the location of the spare tire.
 (→P. 325, 351)

^{*3}: Refer to the "Off-road Driving Owner's Manual".

^{*4}: The location of the license plate lights differs depending on the location of the spare tire. (→P. 567)

■ Instrument panel (Left-hand drive vehicles)

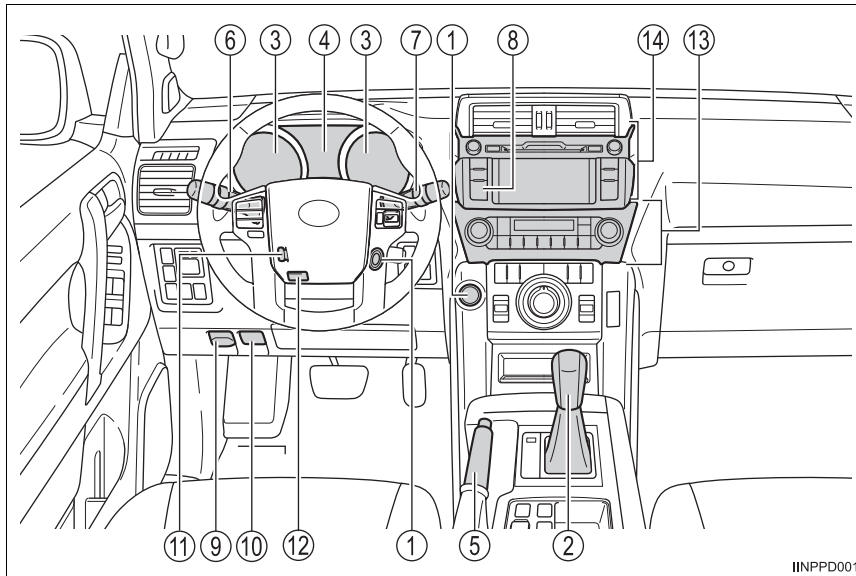

①	Engine switch	P. 240, 243
	Starting the engine/changing the modes	P. 240, 243
	Emergency stop of the engine	P. 585
	When the engine will not start	P. 657
	Warning messages*1	P. 606
②	Shift lever (Automatic transmission)	P. 251
	Changing the shift position	P. 251
	Precautions against towing	P. 589
	When the shift lever does not move	P. 659
	Shift lever (Manual transmission)	P. 258
	Changing the shift position	P. 258
	Precautions against towing	P. 589
③	Meters	P. 105
	Reading the meters	P. 105
	Adjusting the instrument cluster light	P. 107
	Warning lights/indicators	P. 98
	When the warning lights come on	P. 594

- ④ **Multi-information display** **P. 109, 114**
 Display P. 109, 114
 When the warning messages are displayed*1 P. 606
- ⑤ **Parking brake lever** **P. 264**
 Applying/releasing P. 264
 Precautions against winter season P. 388
 Warning buzzer/message P. 600, 608
- ⑥ **Turn signal lever** **P. 263**
Headlight switch **P. 267**
 Headlights/front position lights/tail lights/
 daytime running lights P. 267
 Front fog lights*1/rear fog lights P. 277
- ⑦ **Windshield wiper and washer switch** **P. 279**
 Usage P. 279
 Adding washer fluid P. 535
- ⑧ **Emergency flasher switch** **P. 584**
- ⑨ **Fuel filler door opener** **P. 291**
- ⑩ **Hood lock release lever** **P. 519**
- ⑪ **Tilt and telescopic steering control switch*1** **P. 195**
 Adjustment P. 195
 Driving position memory P. 188
- ⑫ **Tilt and telescopic steering lock release lever*1** **P. 195**
- ⑬ **Front manual air conditioning system** **P. 452**
 Usage P. 452
 Rear window defogger P. 453
Front automatic air conditioning system **P. 458**
 Usage P. 458
 Rear window defogger P. 461
- ⑭ **Audio system*1, 2** **P. 392**
 Audio system*1, 2 P. 392
 Hands-free system*1, 2 P. 424

*1: If equipped

*2: For vehicles with a navigation system or a multimedia system,
 refer to the "Navigation system owner's manual".

■ Switches (Left-hand drive vehicles)

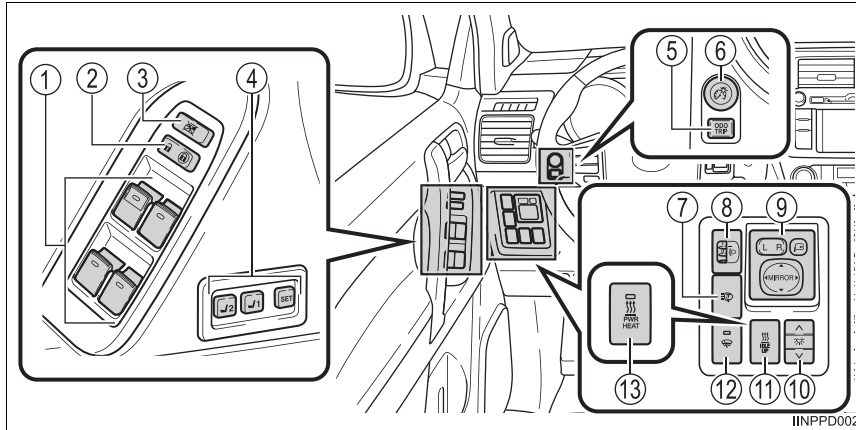

- ① Power window switches P. 203
- ② Door lock switch P. 134
- ③ Window lock switch P. 203
- ④ Driving position memory buttons* P. 188
- ⑤ Odometer/trip meter and trip meter reset button P. 107, 110
- ⑥ Instrument cluster light control dial P. 107
- ⑦ Headlight cleaner switch* P. 286
- ⑧ Manual headlight leveling dial* P. 268
- ⑨ Outside rear view mirror switches P. 200
- ⑩ Lounge illumination control switches* P. 478
- ⑪ Heater idle up switch* P. 454
- ⑫ Windshield wiper de-icer switch* P. 462
- ⑬ Power heater switch* P. 455

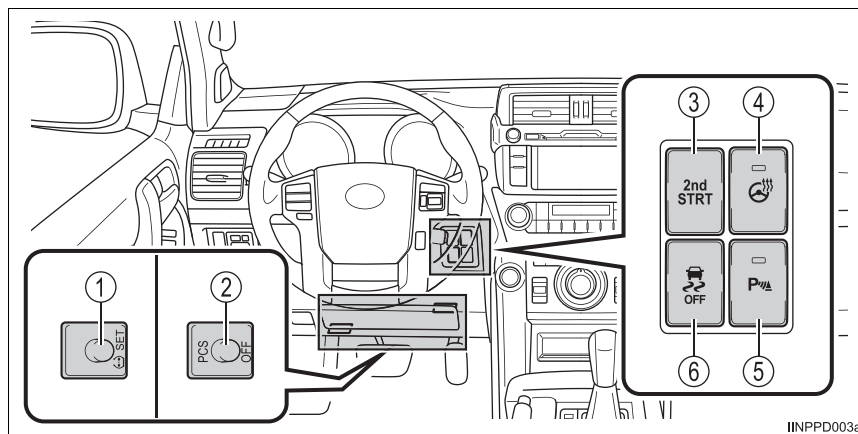

- ① **Tire pressure warning reset switch*** P. 541
- ② **Pre-crash braking off switch*** P. 379
- ③ **“2nd STRT” button*** P. 254
- ④ **Heated steering wheel switch*** P. 473
- ⑤ **Toyota parking assist-sensor switch*** P. 312
- ⑥ **VSC OFF switch**..... P. 362

*: If equipped

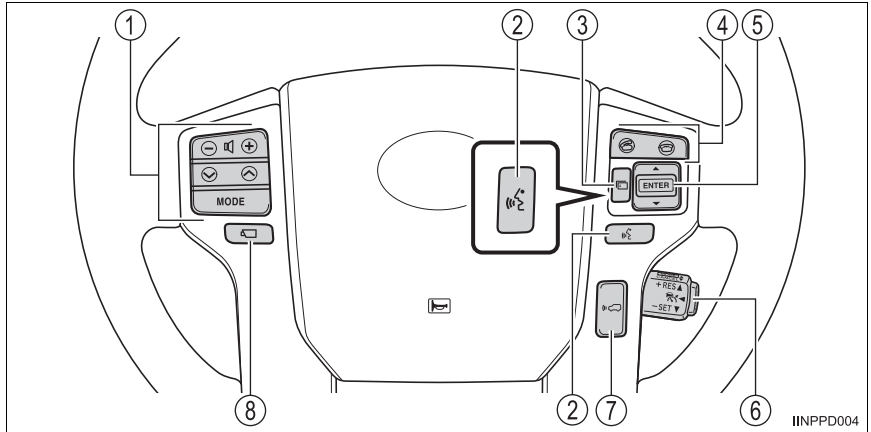

- ① **Audio remote control switches***1, 2 P. 393
- ② **Talk switch***1, 2
- ③ **Menu switch***1 P. 115
- ④ **Telephone switches***1, 2 P. 429
- ⑤ **“ENTER” switch***1 P. 115
- ⑥ **Cruise control switch***1
 Cruise control*1 P. 292
 Dynamic radar cruise control*1 P. 296
- ⑦ **Vehicle-to-vehicle distance button***1 P. 299
- ⑧ **Multi-terrain Monitor switch***1, 3

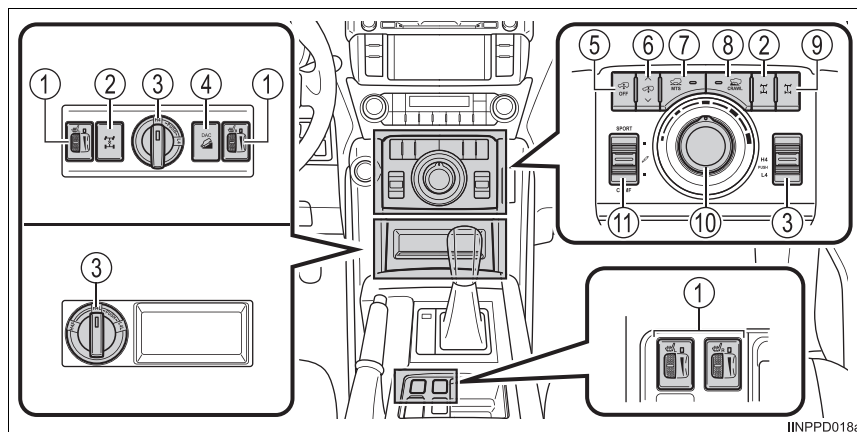

- ① Front seat heater switches*1 P. 474
- ② Center differential lock/unlock switch*1, 3
- ③ Four-wheel drive control switch*3
- ④ “DAC” switch*1, 3
- ⑤ Height control OFF button*1, 3
- ⑥ Height control button*1, 3
- ⑦ Multi-terrain Select ON/OFF switch*1, 3
- ⑧ Crawl Control ON/OFF switch*1, 3
- ⑨ Rear differential lock/unlock switch*1, 3
- ⑩ Multi-terrain Select mode selector dial*1, 3
Crawl Control speed selector dial*1, 3
- ⑪ AVS switch*1, 3

*1: If equipped

*2: For vehicles with a navigation system or a multimedia system, refer to the “Navigation system owner’s manual”.

*3: Refer to the “Off-road driving Owner’s manual”.

■ Interior (Left-hand drive vehicles)

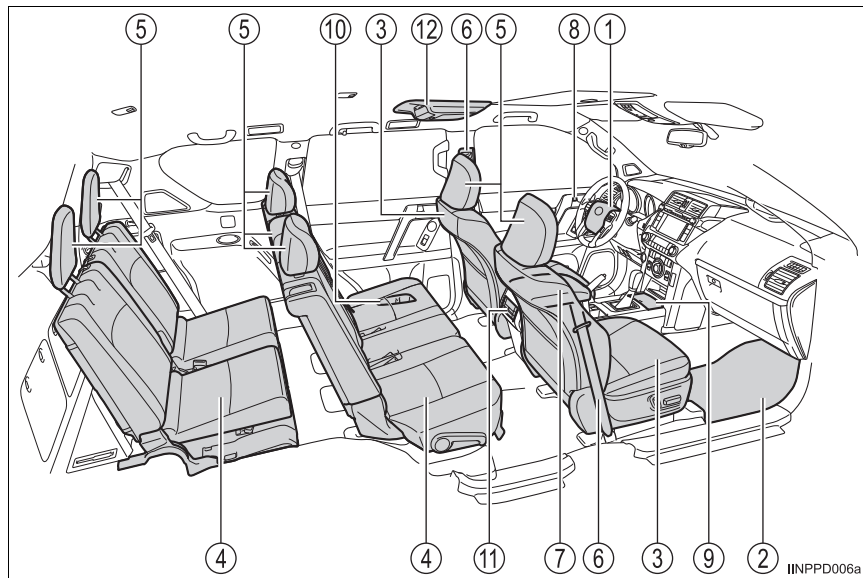

- | | | |
|---|---|-------------|
| ① | SRS airbags | P. 41 |
| ② | Floor mats | P. 32 |
| ③ | Front seats | P. 170 |
| ④ | Rear seats ^{*1} | P. 173 |
| ⑤ | Head restraints | P. 192 |
| ⑥ | Seat belts | P. 36 |
| ⑦ | Console box | P. 482 |
| | Cool box | P. 493 |
| ⑧ | Inside lock buttons | P. 134 |
| ⑨ | Cup holders | P. 484 |
| ⑩ | Bottle holders | P. 485 |
| ⑪ | Rear air conditioning system ^{*1} | P. 467, 469 |
| ⑫ | Rear seat entertainment system ^{*1, 2} | |

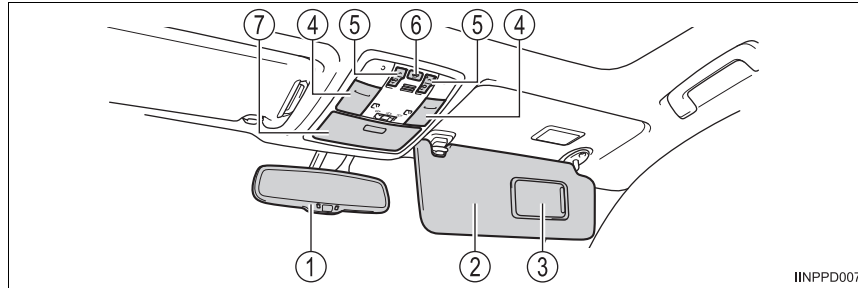

IINPPD007

- ① Inside rear view mirror P. 198
- ② Sun visors*3 P. 495
- ③ Vanity mirrors P. 495
- ④ Personal/interior lights*4 P. 477
- ⑤ Moon roof switches*1 P. 206
- ⑥ Intrusion sensor cancel switch*1 P. 94
- ⑦ Conversation mirror P. 496
- Auxiliary boxes P. 487

*1: If equipped

*2: For vehicles with a navigation system or a multimedia system, refer to the "Navigation system owner's manual".

*3: NEVER use a rearward facing child restraint on a seat protected by an ACTIVE AIRBAG in front of it, DEATH or SERIOUS INJURY to the CHILD can occur. (→P. 79)



*4: The illustration shows the front, but they are also equipped in the rear.

■ Instrument panel (Right-hand drive vehicles)

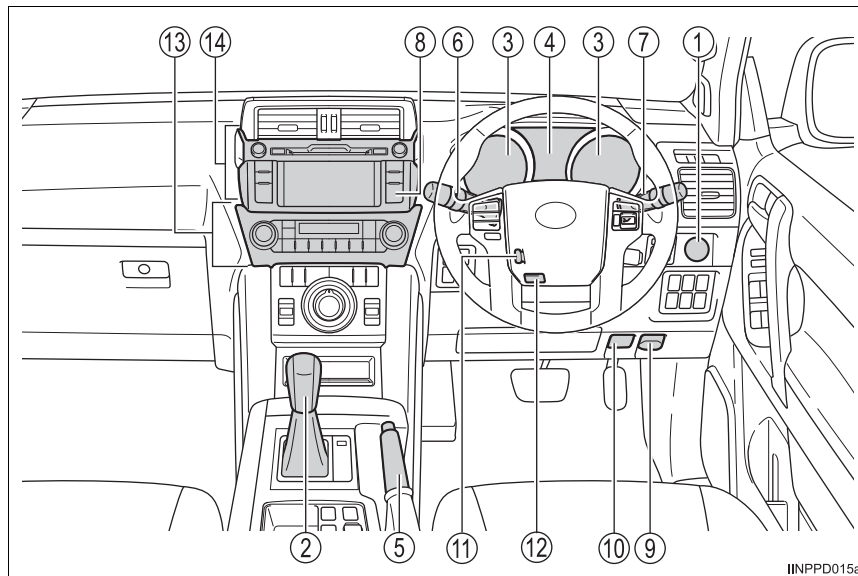

①	Engine switch	P. 243
	Starting the engine/changing the modes	P. 243
	Emergency stop of the engine	P. 585
	When the engine will not start	P. 657
	Warning messages*1	P. 606
②	Shift lever (Automatic transmission)	P. 251
	Changing the shift position	P. 251
	Precautions against towing	P. 589
	When the shift lever does not move	P. 659
	Shift lever (Manual transmission)	P. 258
	Changing the shift position	P. 258
	Precautions against towing	P. 589
③	Meters	P. 105
	Reading the meters	P. 105
	Adjusting the instrument cluster light	P. 107
	Warning lights/indicators	P. 98
	When the warning lights come on	P. 594

- ④ **Multi-information display** **P. 109, 114**
 Display P. 109, 114
 When the warning messages are displayed*1 P. 606
- ⑤ **Parking brake lever** **P. 264**
 Applying/releasing P. 264
 Precautions against winter season P. 388
 Warning buzzer/message P. 600, 608
- ⑥ **Turn signal lever** **P. 263**
Headlight switch **P. 267**
 Headlights/front position lights/tail lights/
 daytime running lights P. 267
 Front fog lights*1/rear fog lights P. 277
- ⑦ **Windshield wiper and washer switch** **P. 279**
 Usage P. 279
 Adding washer fluid P. 535
- ⑧ **Emergency flasher switch** **P. 584**
- ⑨ **Fuel filler door opener** **P. 291**
- ⑩ **Hood lock release lever** **P. 519**
- ⑪ **Tilt and telescopic steering control switch*1** **P. 195**
 Adjustment P. 195
 Driving position memory P. 188
- ⑫ **Tilt and telescopic steering lock release lever*1** **P. 195**
- ⑬ **Front manual air conditioning system** **P. 452**
 Usage P. 452
 Rear window defogger P. 453
Front automatic air conditioning system **P. 458**
 Usage P. 458
 Rear window defogger P. 461
- ⑭ **Audio system*1, 2** **P. 392**
 Audio system*1, 2 P. 392
 Hands-free system*1, 2 P. 424

*1: If equipped

*2: For vehicles with a navigation system or a multimedia system,
 refer to the "Navigation system owner's manual".

■ Switches (Right-hand drive vehicles)

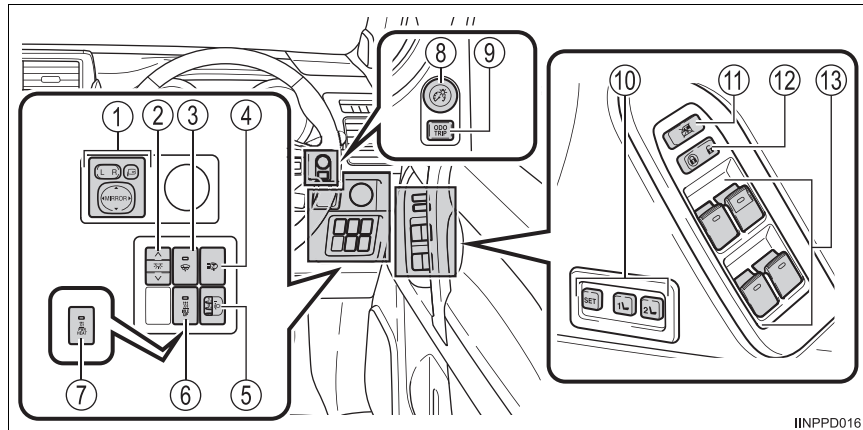

- ① Outside rear view mirror switches P. 200
- ② Lounge illumination control switches* P. 478
- ③ Windshield wiper de-icer switch* P. 462
- ④ Headlight cleaner switch* P. 286
- ⑤ Manual headlight leveling dial* P. 268
- ⑥ Heater idle up switch* P. 454
- ⑦ Power heater switch* P. 455
- ⑧ Instrument cluster light control dial P. 107
- ⑨ Odometer/trip meter and trip meter reset button P. 107, 110
- ⑩ Driving position memory buttons* P. 188
- ⑪ Window lock switch P. 203
- ⑫ Door lock switch P. 134
- ⑬ Power window switches P. 203

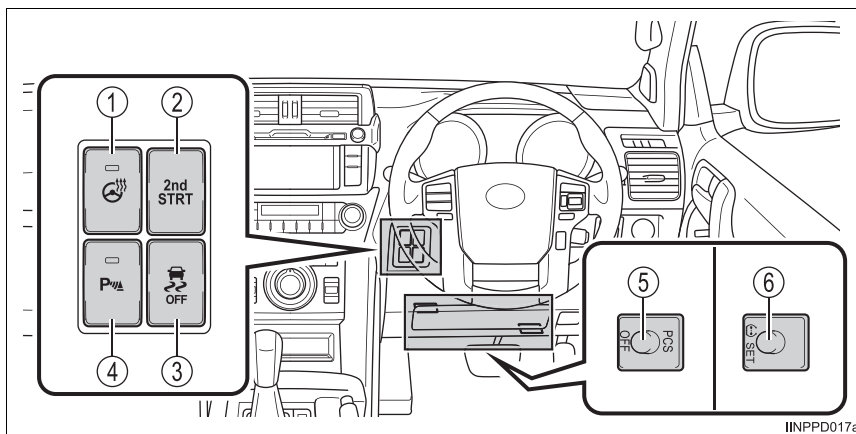

- ① Heated steering wheel switch* P. 473
- ② “2nd STRT” button* P. 254
- ③ VSC OFF switch..... P. 362
- ④ Toyota parking assist-sensor switch* P. 312
- ⑤ Pre-crash braking off switch* P. 379
- ⑥ Tire pressure warning reset switch* P. 541

*: If equipped

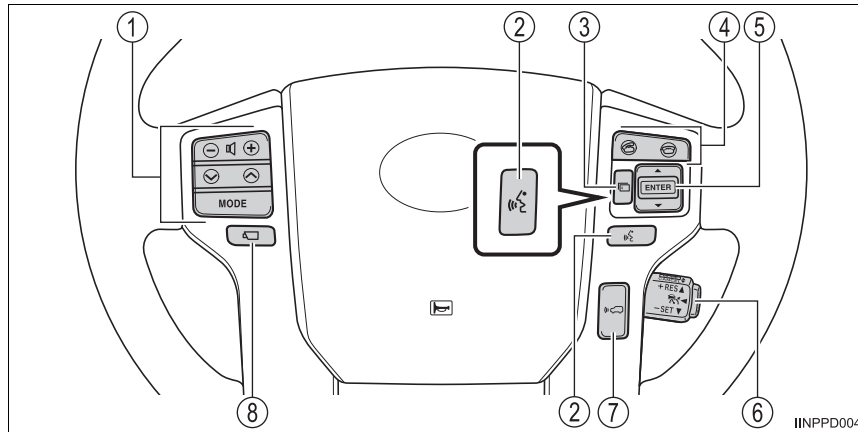

- ① **Audio remote control switches***1, 2 P. 393
- ② **Talk switch***1, 2
- ③ **Menu switch***1 P. 115
- ④ **Telephone switches***1, 2 P. 429
- ⑤ **“ENTER” switch***1 P. 115
- ⑥ **Cruise control switch***1
 Cruise control*1 P. 292
 Dynamic radar cruise control*1 P. 296
- ⑦ **Vehicle-to-vehicle distance button***1 P. 299
- ⑧ **Multi-terrain Monitor switch***1, 3

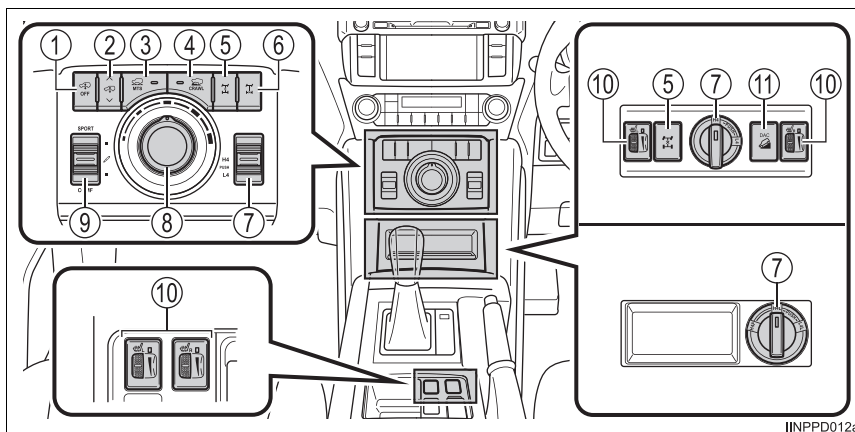

- ① Height control OFF button*1, 3
- ② Height control button*1, 3
- ③ Multi-terrain Select ON/OFF switch*1, 3
- ④ Crawl Control ON/OFF switch*1, 3
- ⑤ Center differential lock/unlock switch*1, 3
- ⑥ Rear differential lock/unlock switch*1, 3
- ⑦ Four-wheel drive control switch*3
- ⑧ Multi-terrain Select mode selector dial*1, 3
Crawl Control speed selector dial*1, 3
- ⑨ AVS switch*1, 3
- ⑩ Front seat heater switches*1 P. 474
- ⑪ “DAC” switch*1, 3

*1: If equipped

*2: For vehicles with a navigation system or a multimedia system, refer to the “Navigation system owner’s manual”.

*3: Refer to the “Off-road driving Owner’s manual”.

■ Interior (Right-hand drive vehicles)

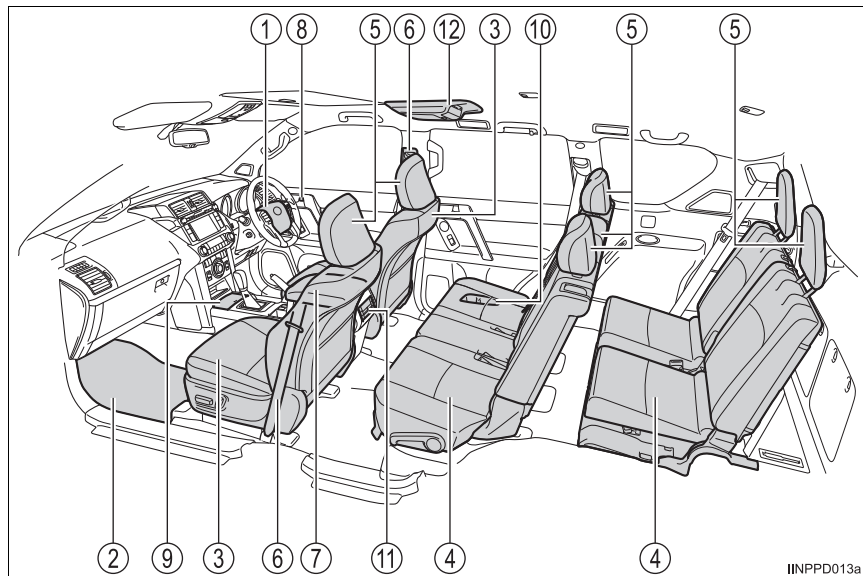

①	SRS airbags	P. 41
②	Floor mats	P. 32
③	Front seats	P. 170
④	Rear seats ^{*1}	P. 173
⑤	Head restraints	P. 192
⑥	Seat belts	P. 36
⑦	Console box	P. 482
	Cool box	P. 493
⑧	Inside lock buttons	P. 134
⑨	Cup holders	P. 484
⑩	Bottle holders	P. 485
⑪	Rear air conditioning system ^{*1}	P. 467, 469
⑫	Rear seat entertainment system ^{*1, 2}	

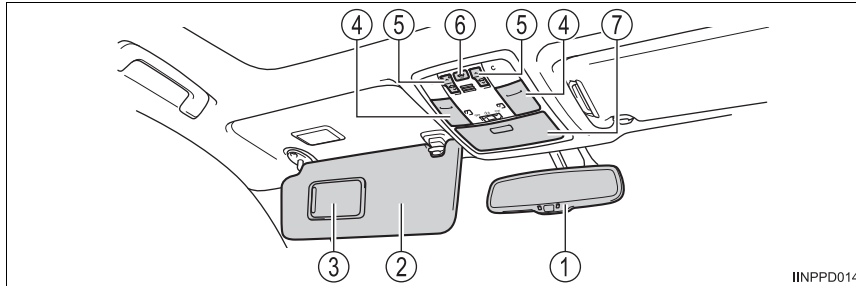

IINPPD014

- ① Inside rear view mirror P. 198
- ② Sun visors*3 P. 495
- ③ Vanity mirrors P. 495
- ④ Personal/interior lights*4 P. 477
- ⑤ Moon roof switches*1 P. 206
- ⑥ Intrusion sensor cancel switch*1 P. 94
 Intrusion sensor and tilt sensor cancel switch*1 P. 94
- ⑦ Conversation mirror P. 496
 Auxiliary boxes P. 487

*1: If equipped

*2: For vehicles with a navigation system or a multimedia system, refer to the "Navigation system owner's manual".

*3: NEVER use a rearward facing child restraint on a seat protected by an ACTIVE AIRBAG in front of it, DEATH or SERIOUS INJURY to the CHILD can occur. (→P. 79)



*4: The illustration shows the front, but they are also equipped in the rear.

For safety and security

1

1-1. For safe use

Before driving.....32
For safety drive34
Seat belts.....36
SRS airbags.....41
Airbag manual on-off
system54
Safety information
for children.....56
Child restraint systems57
Installing child restraints70
Exhaust gas precautions81

1-2. Theft deterrent system

Engine immobilizer
system82
Double locking system.....90
Alarm91

Before driving

Floor mat

Use only floor mats designed specifically for vehicles of the same model and model year as your vehicle. Fix them securely in place onto the carpet.

- 1 Insert the retaining hooks (clips) into the floor mat eyelets.

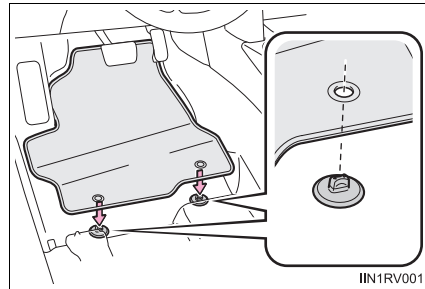

- 2 Turn the upper knob of each retaining hook (clip) to secure the floor mats in place.

*: Always align the \triangle marks.

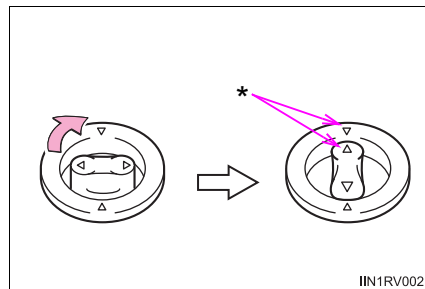

The shape of the retaining hooks (clips) may differ from that shown in the illustration.

⚠ CAUTION

Observe the following precautions.

Failure to do so may cause the driver's floor mat to slip, possibly interfering with the pedals while driving. An unexpectedly high speed may result or it may become difficult to stop the vehicle, leading to an accident, or leading to death or a serious injury.

■ When installing the driver's floor mat

- Do not use floor mats designed for other models or different model year vehicles, even if they are Toyota Genuine floor mats.
- Only use floor mats designed for the driver's seat.
- Always install the floor mat securely using the retaining hooks (clips) provided.
- Do not use two or more floor mats on top of each other.
- Do not place the floor mat bottom-side up or upside-down.

■ Before driving

- Check that the floor mat is securely fixed in the correct place with all the provided retaining hooks (clips). Be especially careful to perform this check after cleaning the floor.
- With the engine stopped and the shift lever in P (automatic transmission) or N (manual transmission), fully depress each pedal to the floor to make sure it does not interfere with the floor mat.

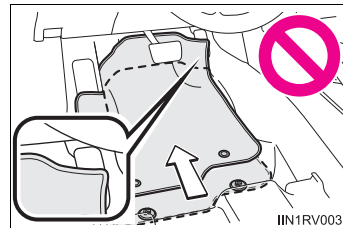

For safety drive

For safe driving, adjust the seat and mirror to an appropriate position before driving.

Correct driving posture

- ① Adjust the angle of the seat-back so that you are sitting straight up and so that you do not have to lean forward to steer. (→P. 170)
- ② Adjust the seat so that you can depress the pedals fully and so that your arms bend slightly at the elbow when gripping the steering wheel. (→P. 170)
- ③ Lock the head restraint in place with the center of the head restraint closest to the top of your ears. (→P. 192)
- ④ Wear the seat belt correctly. (→P. 37)

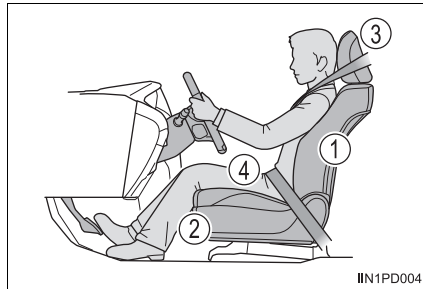

Correct use of the seat belts

Make sure that all occupants are wearing their seat belts before driving the vehicle. (→P. 37)

Use a child restraint system appropriate for the child until the child becomes large enough to properly wear the vehicle's seat belt. (→P. 58)

Adjusting the mirrors

Make sure that you can see backward clearly by adjusting the inside and outside rear view mirrors properly. (→P. 198, 200)

CAUTION

Observe the following precautions.

Failure to do so may result in death or serious injury.

- Do not adjust the position of the driver's seat while driving.
Doing so could cause the driver to lose control of the vehicle.
- Do not place a cushion between the driver or passenger and the seatback.
A cushion may prevent correct posture from being achieved, and reduce the effectiveness of the seat belt and head restraint.
- Do not place anything under the front seats.
Objects placed under the front seats may become jammed in the seat tracks and stop the seat from locking in place. This may lead to an accident and the adjustment mechanism may also be damaged.
- When driving over long distances, take regular breaks before you start to feel tired.
Also, if you feel tired or sleepy while driving, do not force yourself to continue driving and take a break immediately.

1

For safety and security

Seat belts

Make sure that all occupants are wearing their seat belts before driving the vehicle.

Correct use of the seat belts

- Extend the shoulder belt so that it comes fully over the shoulder, but does not come into contact with the neck or slide off the shoulder.
- Position the lap belt as low as possible over the hips.
- Adjust the position of the seat-back. Sit up straight and well back in the seat.
- Do not twist the seat belt.

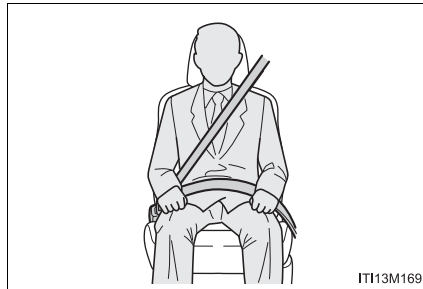

Fastening and releasing the seat belt

- ① To fasten the seat belt, push the plate into the buckle until a click sound is heard.
- ② To release the seat belt, press the release button.

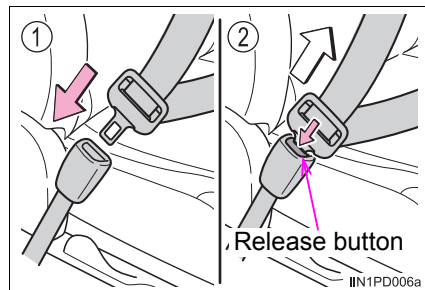

Adjusting the seat belt shoulder anchor height (front and outer second [5-door models] seats)

- ① Push the seat belt shoulder anchor down while pressing the release button.
 - ② Push the seat belt shoulder anchor up.
- Move the height adjuster up and down as needed until you hear a click.

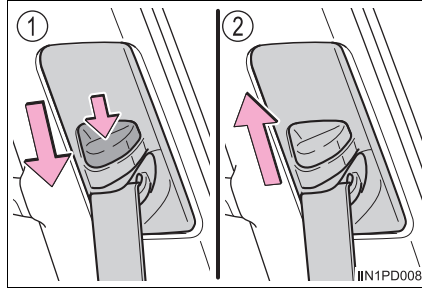

Seat belt pretensioners (front seats)

The pretensioner helps the seat belt to quickly restrain the occupant by retracting the seat belt when the vehicle is subjected to certain types of severe frontal collision or side collision (vehicles with SRS side airbags and curtain shield airbags).

The pretensioner may not activate in the event of a minor frontal or side impact, or a rear impact.

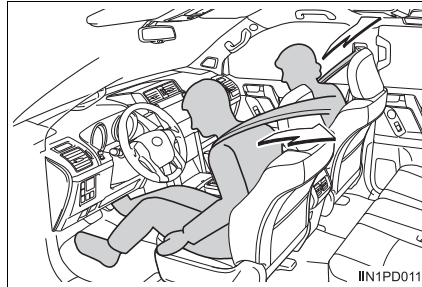

Pre-crash seat belts (front seats of vehicles with pre-crash safety system)

If the system determines that a collision is unavoidable, the front seat belts will retract before the collision. (→P. 378)

■ Emergency locking retractor (ELR)

The retractor will lock the belt during a sudden stop or on impact. It may also lock if you lean forward too quickly. A slow, easy motion will allow the belt to extend so that you can move around fully.

■ Automatic locking retractor (ALR) (if equipped)

When an outer second seat passenger's shoulder belt is completely extended and then retracted even slightly, the belt is locked in that position and cannot be extended. This feature is used to hold the child restraint system (CRS) firmly. To free the belt again, fully retract the belt and then pull the belt out once more. (→P. 71)

■ Child seat belt usage

The seat belts of your vehicle were principally designed for persons of adult size.

- Use a child restraint system appropriate for the child, until the child becomes large enough to properly wear the vehicle's seat belt. (→P. 58)
- When the child becomes large enough to properly wear the vehicle's seat belt, follow the instructions on P. 37 regarding seat belt usage.

■ Replacing the belt after the pretensioner has been activated

If the vehicle is involved in multiple collisions, the pretensioner will activate for the first collision, but will not activate for the second or subsequent collisions.

■ Seat belt regulations

If seat belt regulations exist in the country where you reside, please contact any authorized Toyota dealer or repairer, or another duly qualified and equipped professional for seat belt replacement or installation.

⚠ CAUTION

Observe the following precautions to reduce the risk of injury in the event of sudden braking, sudden swerving or an accident. Failure to do so may cause death or serious injury.

■ Wearing a seat belt

- Ensure that all passengers wear a seat belt.
- Always wear a seat belt properly.
- Each seat belt should be used by one person only. Do not use a seat belt for more than one person at once, including children.
- Toyota recommends that children be seated in the rear seat and always use a seat belt and/or an appropriate child restraint system.
- To achieve a proper seating position, do not recline the seat more than necessary. The seat belt is most effective when the occupants are sitting up straight and well back in the seats.
- Do not wear the shoulder belt under your arm.
- Always wear your seat belt low and snug across your hips.

■ Pregnant women

Obtain medical advice and wear the seat belt in the proper way. (→P. 37)

Women who are pregnant should position the lap belt as low as possible over the hips in the same manner as other occupants, extending the shoulder belt completely over the shoulder and avoiding belt contact with the rounding of the abdominal area.

If the seat belt is not worn properly, not only the pregnant woman, but also the fetus could suffer death or serious injury as a result of sudden braking, sudden swerving or a collision.

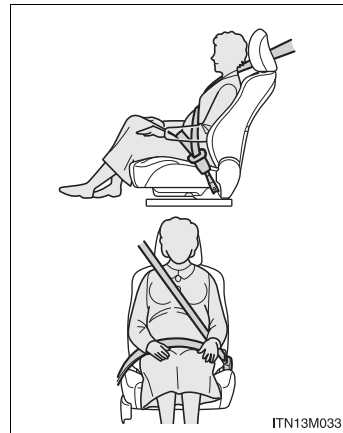

 CAUTION**■ People suffering illness**

Obtain medical advice and wear the seat belt in the proper way. (→P. 37)

■ When children are in the vehicle

Do not allow children to play with the seat belt. If the seat belt becomes twisted around a child's neck, it may lead to choking or other serious injuries that could result in death.

If this occurs and the buckle cannot be unfastened, scissors should be used to cut the belt.

■ Seat belt pretensioners

If the pretensioner has activated, the SRS warning light will come on. In that case, the seat belt cannot be used again and must be replaced at any authorized Toyota dealer or repairer, or another duly qualified and equipped professional.

■ Adjustable shoulder anchor

Always make sure the shoulder belt is positioned across the center of your shoulder. The belt should be kept away from your neck, but not falling off your shoulder. Failure to do so could reduce the amount of protection in an accident and cause death or serious injuries in the event of a sudden stop, sudden swerve or accident. (→P. 38)

■ Seat belt damage and wear

- Do not damage the seat belts by allowing the belt, plate, or buckle to be jammed in the door.
- Inspect the seat belt system periodically. Check for cuts, fraying, and loose parts. Do not use a damaged seat belt until it is replaced. Damaged seat belt cannot protect an occupant from death or serious injury.
- Ensure that the belt and plate are locked and the belt is not twisted.
If the seat belt does not function correctly, immediately contact any authorized Toyota dealer or repairer, or another duly qualified and equipped professional.
- Replace the seat assembly, including the belts, if your vehicle has been involved in a serious accident, even if there is no obvious damage.
- Do not attempt to install, remove, modify, disassemble or dispose of the seat belts. Have any necessary repairs carried out by any authorized Toyota dealer or repairer, or another duly qualified and equipped professional. Inappropriate handling may lead to incorrect operation.

SRS airbags

The SRS airbags inflate when the vehicle is subjected to certain types of severe impacts that may cause significant injury to the occupants. They work together with the seat belts to help reduce the risk of death or serious injury.

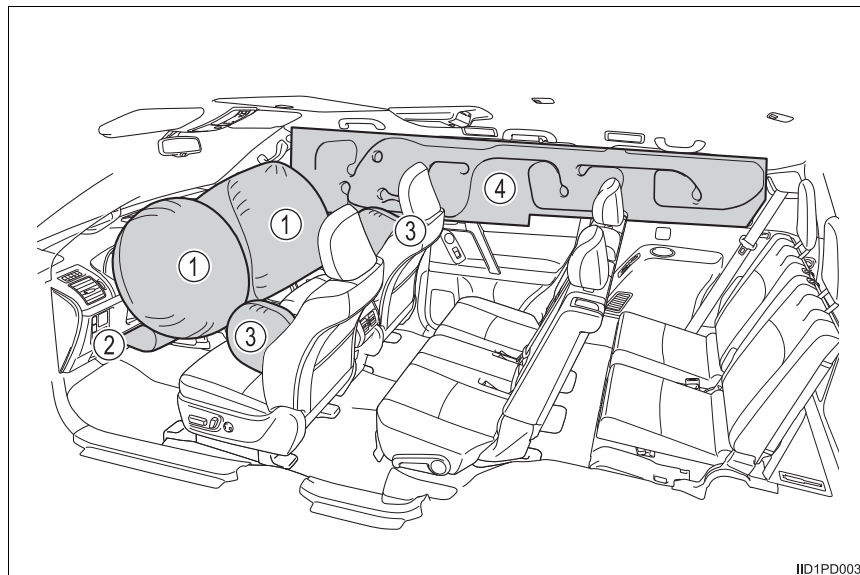

◆ SRS front airbags

- ① SRS driver airbag/front passenger airbag
Can help protect the head and chest of the driver and front passenger from impact with interior components
- ② SRS driver knee airbag (if equipped)
Can help provide driver protection

◆ SRS side and curtain shield airbags

- ③ SRS side airbags (if equipped)
Can help protect the torso of the front seat occupants
- ④ SRS curtain shield airbags (if equipped)
Can help protect primarily the head of occupants in the outer seats

Airbag system components

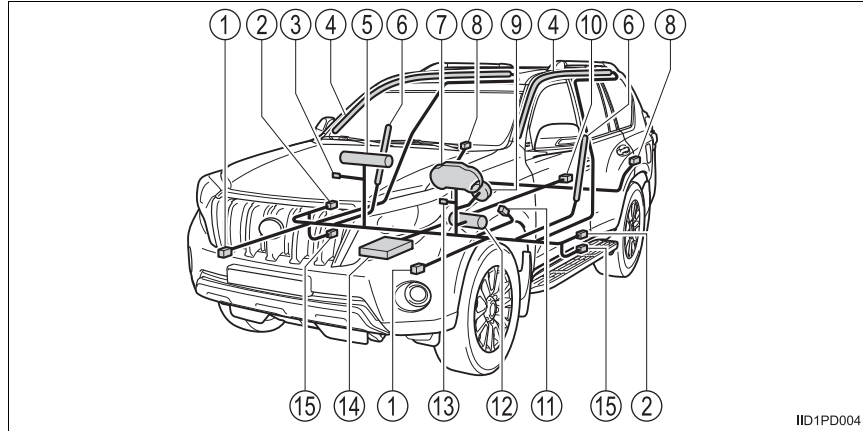

- | | |
|--|---|
| ① Front impact sensors | ⑨ Driver airbag |
| ② Side impact sensors (front)
(if equipped) | ⑩ Safing sensor (rear)
(if equipped) |
| ③ Airbag manual on-off switch
(if equipped) | ⑪ Driver's seat belt buckle
switch |
| ④ Curtain shield airbags
(if equipped) | ⑫ Driver knee airbag
(if equipped) |
| ⑤ Front passenger airbag | ⑬ Airbag manual off indicator
(if equipped) |
| ⑥ Side airbags (if equipped) | ⑭ Airbag sensor assembly |
| ⑦ SRS warning light | ⑮ Seat belt pretensioners and
force limiters |
| ⑧ Side impact sensors (rear)
(if equipped) | |

The main SRS airbag system components are shown above. The SRS airbag system is controlled by the airbag sensor assembly. As the airbags deploy, a chemical reaction in the inflators quickly fills the airbags with non-toxic gas to help restrain the motion of the occupants.

 CAUTION

■ **SRS airbag precautions**

Observe the following precautions regarding the SRS airbags. Failure to do so may cause death or serious injury.

- The driver and all passengers in the vehicle must wear their seat belts properly.

The SRS airbags are supplemental devices to be used with the seat belts.

- The SRS driver airbag deploys with considerable force, and can cause death or serious injury especially if the driver is very close to the airbag.

Since the risk zone for the driver's airbag is the first 50 - 75 mm (2 - 3 in.) of inflation, placing yourself 250 mm (10 in.) from your driver airbag provides you with a clear margin of safety. This distance is measured from the center of the steering wheel to your breastbone. If you sit less than 250 mm (10 in.) away now, you can change your driving position in several ways:

- Move your seat to the rear as far as you can while still reaching the pedals comfortably.
- Slightly recline the back of the seat. Although vehicle designs vary, many drivers can achieve the 250 mm (10 in.) distance, even with the driver seat all the way forward, simply by reclining the back of the seat somewhat. If reclining the back of your seat makes it hard to see the road, raise yourself by using a firm, non-slippery cushion, or raise the seat if your vehicle has that feature.
- If your steering wheel is adjustable, tilt it downward. This points the airbag toward your chest instead of your head and neck.

The seat should be adjusted as recommended above, while still maintaining control of the foot pedals, steering wheel, and your view of the instrument panel controls.

⚠ CAUTION**■ SRS airbag precautions**

- The SRS front passenger airbag also deploys with considerable force, and can cause death or serious injury especially if the front passenger is very close to the airbag. The front passenger seat should be as far from the airbag as possible with the seatback adjusted, so the front passenger sits upright.
- Improperly seated and/or restrained infants and children can be killed or seriously injured by a deploying airbag. An infant or child who is too small to use a seat belt should be properly secured using a child restraint system. Toyota strongly recommends that all infants and children be placed in the rear seats of the vehicle and properly restrained. The rear seats are safer for infants and children than the front passenger seat. (→P. 58)
- Do not sit on the edge of the seat or lean against the dashboard.

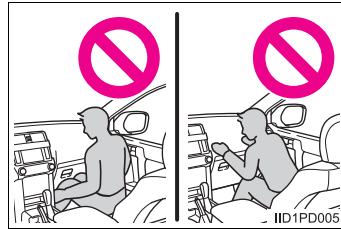

- Do not allow a child to stand in front of the SRS front passenger airbag unit or sit on the knees of a front passenger.
- Do not allow the front seat occupants to hold items on their knees.

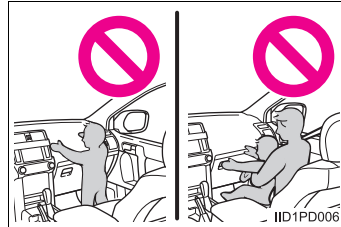

⚠ CAUTION**■ SRS airbag precautions**

- Vehicles without SRS curtain shield airbags:

Do not lean against the front door.

Vehicles with SRS curtain shield airbags:

Do not lean against the door, the roof side rail or the front, center and rear pillars.

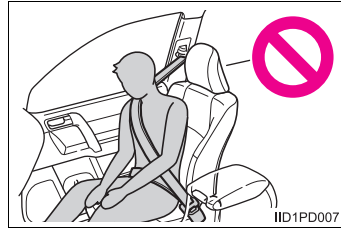

- Vehicles with SRS side airbags:

Do not allow anyone to kneel on the passenger seats toward the door or put their head or hands outside the vehicle.

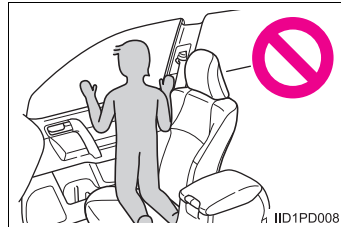

- Do not attach anything to or lean anything against areas such as the dashboard, steering wheel pad and lower portion of the instrument panel. These items can become projectiles when the SRS driver, front passenger and knee airbags (if equipped) deploy.

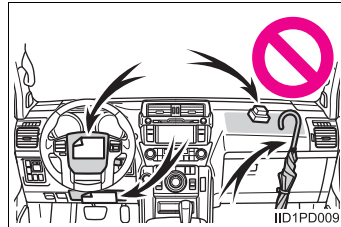

CAUTION**SRS airbag precautions**

- Vehicles with SRS curtain shield airbags:
Do not attach anything to areas such as the door, windshield glass, side door glass, front, center or rear pillars, roof side rail and assist grip.

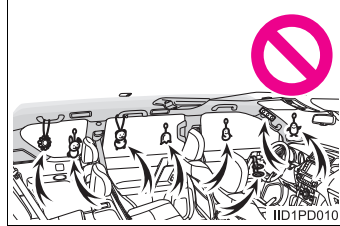

- Vehicles without a smart entry & start system:
Do not attach any heavy, sharp or hard objects such as keys or accessories to the key. The objects may restrict the SRS knee airbag (if equipped) inflation or be thrust into the driver's seat area by the force of the deploying airbag, thus causing a danger.

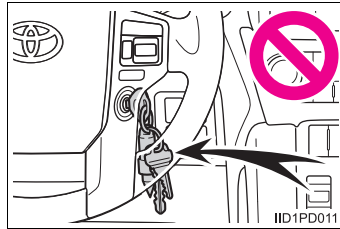

- Vehicles with SRS curtain shield airbags:
Do not hang coat hangers or other hard objects on the coat hooks. All of these items could become projectiles and may cause death or serious injury, should the SRS curtain shield airbag deploy.
- Vehicles with SRS knee airbag:
If the vinyl cover is put on the area where the SRS knee airbag will deploy, be sure to remove it.

**CAUTION****■ SRS airbag precautions**

- Vehicles with SRS side airbags:
Do not use seat accessories which cover the parts where the SRS side airbags inflate as they may interfere with inflation of the airbags. Such accessories may prevent the side airbags from activating correctly, disable the system or cause the side airbags to inflate accidentally, resulting in death or serious injury.
- Do not strike or apply significant levels of force to the area of the SRS airbag components.
Doing so can cause the SRS airbags to malfunction.
- Do not touch any of the component parts immediately after the SRS airbags have deployed (inflated) as they may be hot.
- If breathing becomes difficult after the SRS airbags have deployed, open a door or window to allow fresh air in, or leave the vehicle if it is safe to do so. Wash off any residue as soon as possible to prevent skin irritation.
- If the areas where the SRS airbags are stored, such as the steering wheel pad and front, center and rear pillar garnishes, are damaged or cracked, have them replaced by any authorized Toyota dealer or repairer, or another duly qualified and equipped professional.

 CAUTION**■ Modification and disposal of SRS airbag system components**

Do not dispose of your vehicle or perform any of the following modifications without consulting any authorized Toyota dealer or repairer, or another duly qualified and equipped professional. The SRS airbags may malfunction or deploy (inflate) accidentally, causing death or serious injury.

- Installation, removal, disassembly and repair of the SRS airbags
- Repairs, modifications, removal or replacement of the steering wheel, instrument panel, dashboard, seats or seat upholstery, front, center and rear pillars or roof side rail
- Repairs or modifications of the front fender, front bumper, or side of the occupant compartment
- Installation of a grille guard (bull bars, kangaroo bar, etc.), snow plows or winches
- Modifications to the vehicle's suspension system
- Installation of electronic devices such as mobile two-way radios (RF-transmitter) and CD players
- Modifications to your vehicle for a person with a physical disability

■ If the SRS airbags deploy (inflate)

- Bruising and slight abrasions may result from contact with a deploying (inflating) SRS airbag.
- A loud noise and white powder will be emitted.
- Vehicles with SRS curtain shield airbags:
Parts of the airbag module (steering wheel hub, airbag cover and inflator) as well as the front seats, parts of the front, center and rear pillars and roof side rail, may be hot for several minutes. The airbag itself may also be hot.
Vehicles without SRS curtain shield airbags:
Parts of the airbag module (steering wheel hub, airbag cover and inflator) as well as the front seats may be hot for several minutes. The airbag itself may also be hot.
- The windshield may crack.

■ SRS airbag deployment conditions (SRS front airbags)

- The SRS front airbag will deploy in the event of an impact that exceeds the set threshold level (the level of force corresponding to an approximately 20 - 30 km/h [12 - 18 mph] frontal collision with a fixed wall that does not move or deform).

However, this threshold velocity will be considerably higher in the following situations:

- If the vehicle strikes an object, such as a parked vehicle or sign pole, which can move or deform on impact
 - If the vehicle is involved in an underride collision, such as a collision in which the front of the vehicle “underrides”, or goes under, the bed of a truck
- Depending on the type of collision, it is possible that only the seat belt pretensioners will activate.

■ SRS airbag deployment conditions (SRS side airbags and curtain shield airbags)

The SRS side and curtain shield airbags will deploy in the event of an impact that exceeds the set threshold level (the level of force corresponding to the impact force produced by an approximately 1500 kg [3300 lb.] vehicle colliding with the vehicle cabin from a direction perpendicular to the vehicle orientation at an approximate speed of 20 - 30 km/h [12 - 18 mph]).

■ Conditions under which the SRS airbags may deploy (inflate), other than a collision

The SRS front airbags may also deploy if a serious impact occurs to the underside of your vehicle. Some examples are shown in the illustration.

- Hitting a curb, edge of pavement or hard surface
- Falling into or jumping over a deep hole
- Landing hard or falling

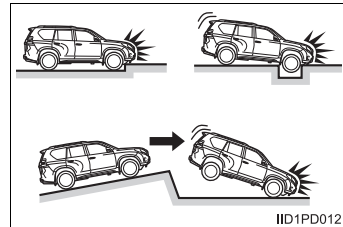

■ **Types of collisions that may not deploy the SRS airbags (SRS front airbags)**

The SRS front airbags are generally not designed to inflate if the vehicle is involved in a side or rear collision, if it rolls over, or if it is involved in a low-speed frontal collision. But, whenever a collision of any type causes sufficient forward deceleration of the vehicle, deployment of the SRS front airbags may occur.

- Collision from the side
- Collision from the rear
- Vehicle rollover

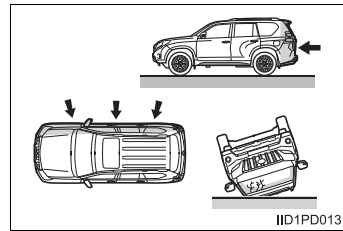

■ **Types of collisions that may not deploy the SRS airbags (SRS side airbags and curtain shield airbags)**

The SRS side airbag and curtain shield airbag system may not activate if the vehicle is subjected to a collision from the side at certain angles, or a collision to the side of the vehicle body other than the passenger compartment.

- Collision from the side to the vehicle body other than the passenger compartment
- Collision from the side at an angle

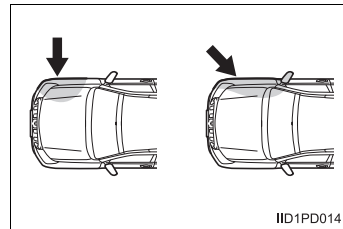

The SRS side airbags and curtain shield airbags are not generally designed to inflate if the vehicle is involved in a frontal or rear collision, if it rolls over, or if it is involved in a low-speed side collision.

- Collision from the front
- Collision from the rear
- Vehicle rollover

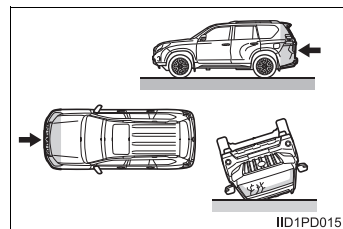

■ **When to contact any authorized Toyota dealer or repairer, or another duly qualified and equipped professional**

In the following cases, the vehicle will require inspection and/or repair. Contact any authorized Toyota dealer or repairer, or another duly qualified and equipped professional as soon as possible.

- Any of the SRS airbags have been inflated.
- The front of the vehicle is damaged or deformed, or was involved in an accident that was not severe enough to cause the SRS airbags to inflate.

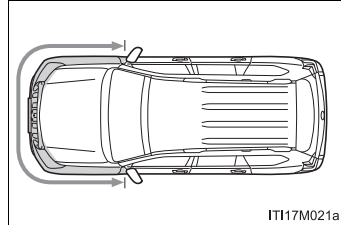

- Vehicles with SRS side and curtain shield airbags:
A portion of a door is damaged or deformed, or the vehicle was involved in an accident that was not severe enough to cause the SRS side airbags and curtain shield airbags to inflate.

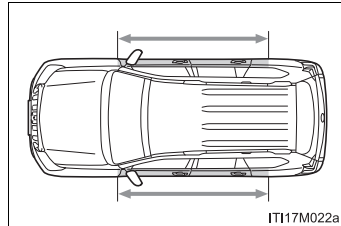

- Vehicles without an SRS knee airbag:
The pad section of the steering wheel or dashboard near the front passenger airbag is scratched, cracked, or otherwise damaged.

Vehicles with an SRS knee airbag:
The pad section of the steering wheel, dashboard near the front passenger airbag cover or lower portion of the instrument panel is scratched, cracked, or otherwise damaged.

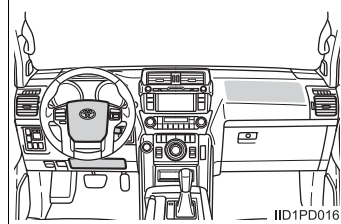

- Vehicles with SRS side airbags:
The surface of the seats with the side airbag is scratched, cracked or otherwise damaged.

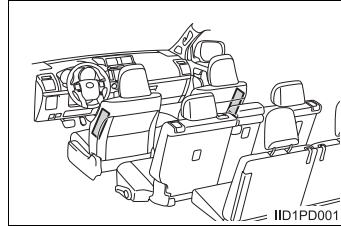

- Vehicles with SRS curtain shield airbags:
The portion of the front pillars, center pillars, rear pillars or roof side rail garnishes (padding) containing the curtain shield airbags inside is scratched, cracked or otherwise damaged.

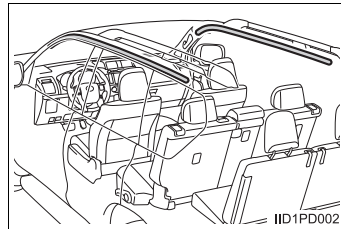

Airbag manual on-off system*

This system deactivates the front passenger airbag.
Only deactivate the airbag when using a child restraint system on the front passenger seat.

① Airbag off indicator

This indicator light turns on when the engine switch is in IGNITION ON mode.

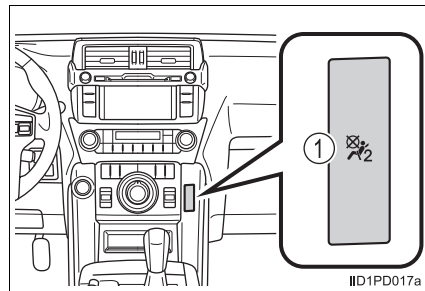

② Airbag manual on-off switch

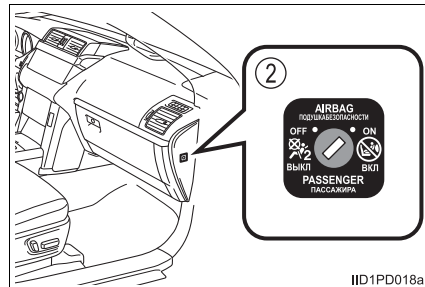

Deactivating the front seat passenger airbag

Insert the mechanical key into the cylinder and rotate to the "OFF" position.

The indicator light turns on (only when the engine switch is in IGNITION ON mode).

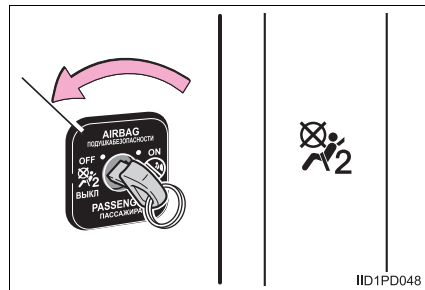

*: If equipped

■ Airbag off indicator

If any of the following problems occur, it is possible that there is a malfunction in the system. Have the vehicle inspected by any authorized Toyota dealer or repairer, or another duly qualified and equipped professional.

- The indicator light does not come on when the airbag manual on-off switch is switched to "OFF".
- The indicator light does not go off when the airbag manual on-off switch is switched to "ON".

**CAUTION****■ When installing a child restraint system**

For safety reasons, always install the child restraint system in a rear seat. In the event that the rear seat cannot be used, the front seat can be used as long as the airbag manual on-off system is set to "OFF".

If the airbag manual on-off system is left on, the strong impact of the airbag deployment (inflation) may cause serious injury or even death.

■ When a child restraint system is not installed on the front passenger seat

Ensure that the airbag manual on-off system is set to "ON".

If it is left off, the airbag may not deploy in the event of an accident, which may result in serious injury or even death.

Safety information for children

Observe the following precautions when children are in the vehicle.

Use a child restraint system appropriate for the child, until the child becomes large enough to properly wear the vehicle's seat belt.

- It is recommended that children sit in the rear seats to avoid accidental contact with the shift lever, wiper switch etc.
- Use the rear door child-protector lock or the window lock switch to avoid children opening the door while driving or operating the power window accidentally.
- Do not let small children operate equipment which may catch or pinch body parts, such as the power window, hood, back door, seats etc.



CAUTION

Never leave children unattended in the vehicle, and never allow children to have or use the key.

Children may be able to start the vehicle or shift the vehicle into neutral. There is also a danger that children may injure themselves by playing with the windows, the moon roof (if equipped) or other features of the vehicle. In addition, heat build-up or extremely cold temperatures inside the vehicle can be fatal to children.

Child restraint systems

Toyota strongly urges the use of child restraint systems.

Points to remember

Studies have shown that installing a child restraint on a rear seat is much safer than installing one to the front passenger seat.

- Choose a child restraint system that suits your vehicle and is appropriate to the age and size of the child.
- For installation details, follow the instructions provided with the child restraint system.

General installation instructions are provided in this manual.

(→P. 71)

- If child restraint system regulations exist in the country where you reside, please contact any authorized Toyota dealer or repairer, or another duly qualified and equipped professional for the child restraint system installation.
- Toyota recommends that you use a child restraint system which conforms to the regulation ECE No.44.

1

For safety and security

Types of child restraints

Child restraint systems are classified into the following 5 groups according to the regulation ECE No.44.

Group 0: Up to 10 kg (22 lb.) (0 - 9 months)

Group 0+: Up to 13 kg (28 lb.) (0 - 2 years)

Group I: 9 to 18 kg (20 to 39 lb.) (9 months - 4 years)

Group II: 15 to 25 kg (34 to 55 lb.) (4 years - 7 years)

Group III: 22 to 36 kg (49 to 79 lb.) (6 years - 12 years)

In this owner's manual, the following 3 types of popular child restraint systems that can be secured with the seat belts are explained:

► Baby seat

Equal to Group 0 and 0+ of ECE No.44



► Child seat

Equal to Group 0+ and I of ECE No.44

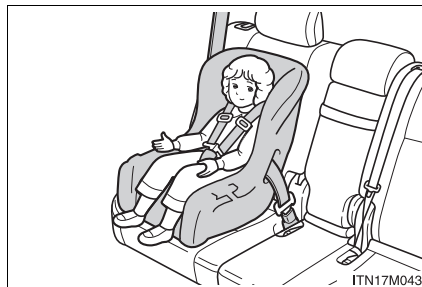

► Junior seat

Equal to Group II and III of ECE No.44

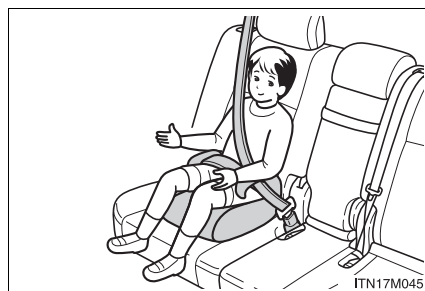

Child restraint system suitability for various seating positions

Information provided in the table shows your child restraint system suitability for various seating positions.

► 3-door models

Seating position Mass groups	Front passenger seat			Second seat	
	Standard	Airbag manual on-off switch		Outboard	Center
		ON	OFF		
0 Up to 10 kg (22 lb.) (0 - 9 months)	X Never put	X Never put	U*1	U	U
0+ Up to 13 kg (28 lb.) (0 - 2 years)	X Never put	X Never put	U*1	U	U
I 9 to 18 kg (20 to 39 lb.) (9 months - 4 years)	Rear- facing — X Never put	Rear- facing — X Never put	U*1	U*2	U*2
	Forward- facing — UF*1	Forward- facing — UF*1			
II, III 15 to 36 kg (34 to 79 lb.) (4 - 12 years)	UF*1	UF*1	U*1	U*2	U*2

Key of letters inserted in the above table:

U: Suitable for “universal” category child restraint system approved for the use in this mass group.

UF: Suitable for forward-facing “universal” category child restraint system approved for the use in this mass group.

X: Not suitable seat position for children in this mass group.

NOTE:

*1: Adjust the seatback to the most upright position.

If the head restraint interferes with your child restraint system, and the head restraint can be removed, remove the head restraint.

If the passenger seat is equipped with a vertical height adjuster, it must be placed in the upper most position.

Follow these procedures:

- For installing a baby seat with support base
If the baby seat interferes with the seatback when latching the baby seat into the support base, adjust the seatback rearward until there is no interference.
- For installing a forward-facing child seat
If there is gap between the child seat and the seatback, tilt the seatback rearward until good contact is achieved.
If the seat belt shoulder anchor is ahead of the child seat belt guide, move the seat cushion forward.
- For installing a junior seat
If the child in your child restraint system is in a very upright position, adjust the seatback to the most comfortable position.
If the seat belt shoulder anchor is ahead of the child seat belt guide, move the seat cushion forward.

*2: If the head restraint interferes with your child restraint system, and the head restraint can be removed, remove the head restraint.

The child restraint systems mentioned in the table may not be available outside of the EU area.

Other child restraint systems which are different from the systems mentioned in the table can be used, but the suitability of the systems must be carefully checked with the child restraint system manufacturer concerned and the seller of those seats.

► 5-door models

Seating position Mass groups	Front passenger seat			Second seat		Third seat (if equipped)
	Standard	Airbag manual on-off switch		Out-board	Center	
		ON	OFF			
0 Up to 10 kg (22 lb.) (0 - 9 months)	X Never put	X Never put	U*1	U	L1	L1
0+ Up to 13 kg (28 lb.) (0 - 2 years)	X Never put	X Never put	U*1	U	L1	L1
I 9 to 18 kg (20 to 39 lb.) (9 months - 4 years)	Rear-facing — X Never put	Rear-facing — X Never put	U*1	U*2	L2*3	L2*4
	Forward-facing — UF*1	Forward-facing — UF*1				
II, III 15 to 36 kg (34 to 79 lb.) (4 - 12 years)	UF*1	UF*1	U*1	U*2	L3*3	L3*5

1

For safety and security

Key of letters inserted in the above table:

- U: Suitable for “universal” category child restraint system approved for the use in this mass group.
- UF: Suitable for forward-facing “universal” category child restraint system approved for the use in this mass group.
- L1: Suitable for “TOYOTA G 0+, BABYSAFE PLUS” (0 to 13 kg [0 to 28 lb.]) and “TOYOTA MINI” (0 to 13 kg [0 to 28 lb.]) approved for the use in this mass group.
- L2: Suitable for “TOYOTA DUO+” (without ISOFIX, 9 to 18 kg [20 to 39 lb.]) approved for the use in this mass group.
- L3: Suitable for “TOYOTA KID” (15 to 36 kg [34 to 79 lb.]) approved for the use in this mass group.
- X: Not suitable seat position for children in this mass group.

NOTE:

- *1: Adjust the seatback to the most upright position.
If the head restraint interferes with your child restraint system, and the head restraint can be removed, remove the head restraint.
If the passenger seat is equipped with a vertical height adjuster, it must be placed in the upper most position.
Follow these procedures:
- For installing a baby seat with support base
If the baby seat interferes with the seatback when latching the baby seat into the support base, adjust the seatback rearward until there is no interference.
 - For installing a forward-facing child seat
If there is gap between the child seat and the seatback, tilt the seatback rearward until good contact is achieved.
If the seat belt shoulder anchor is ahead of the child seat belt guide, move the seat cushion forward.
 - For installing a junior seat
If the child in your child restraint system is in a very upright position, adjust the seatback to the most comfortable position.
If the seat belt shoulder anchor is ahead of the child seat belt guide, move the seat cushion forward.
- *2: If the head restraint interferes with your child restraint system, and the head restraint can be removed, remove the head restraint.
- *3: When you use a child restraint system in this position, move the head restraint to the lowest position.
- *4: When you use a child restraint system in this position, move the head restraint to the upmost position. (vehicles with third manual seats)
- *5: When you use a child restraint system in this position, remove the head restraint. (vehicles with third manual seats)

The child restraint systems mentioned in the table may not be available outside of the EU area.

Other child restraint systems which are different from the systems mentioned in the table can be used, but the suitability of the systems must be carefully checked with the child restraint system manufacturer concerned and the seller of those seats.

Child restraint system suitability for various seating positions (with ISOFIX rigid anchors)

Information provided in the table shows your child restraint system suitability for various seating positions.

► 3-door models

Mass groups	Size class	Fixture	Vehicle ISOFIX positions	
			Outboard second seat	
			Right-hand	Left-hand
Carycot	F	ISO/L1	X	X
	G	ISO/L2	X	X
		(1)	X	X
0 Up to 10 kg (22 lb.) (0 - 9 months)	E	ISO/R1	IL1	X
		(1)	X	X
0+ Up to 13 kg (28 lb.) (0 - 2 years)	E	ISO/R1	IL1	X
	D	ISO/R2	IL1	X
	C	ISO/R3	IL1	X
		(1)	X	X
I 9 to 18 kg (20 to 39 lb.) (9 months - 4 years)	D	ISO/R2	X	X
	C	ISO/R3	X	X
	B	ISO/F2	IUF*, IL2*	IUF*
	B1	ISO/F2X	IUF*, IL2*	IUF*
	A	ISO/F3	IUF*, IL2*	IUF*
		(1)	X	X
II, III 15 to 36 kg (34 to 79 lb.) (4 - 12 years)		(1)	X	X

- (1) For the child restraint system which do not carry the ISO/XX size class identification (A to G), for the applicable mass group, the car manufacturer shall indicate the vehicle specific ISOFIX child restraint system(s) recommended for each position.

Key of letters inserted in the above table:

IUF: Suitable for ISOFIX forward-facing child restraint systems of universal category approved for use in this mass group.

IL1: Suitable for "TOYOTA MINI with BASE" (0 to 13 kg [0 to 28 lb.]) and "TOYOTA MIDI" (0 to 13 kg [0 to 28 lb.]) approved for the use in this mass group.

IL2: Suitable for "TOYOTA MIDI" (9 to 18 kg [20 to 39 lb.]) approved for the use in this mass group.

When using a "TOYOTA MINI" or "TOYOTA MIDI", adjust the support leg and ISOFIX connectors as follows:

- ① Lock the support leg where 5th hole can be seen.
- ② Lock the ISOFIX connectors where number 3 can be seen.

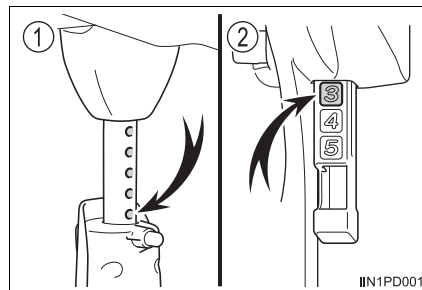

X: ISOFIX position not suitable for ISOFIX child restraint systems in this mass group and/or this size class.

*: If the head restraint interferes with your child restraint system, and the head restraint can be removed, remove the head restraint.

The child restraint systems mentioned in the table may not be available outside of the EU area.

Other child restraint systems different from the systems mentioned in the table can be used, but the suitability of the systems must be carefully checked with the child restraint system manufacturer and retailer.

► 5-door models

Mass groups	Size class	Fixture	Vehicle ISOFIX positions
			Outboard second seat
Carrycot	F	ISO/L1	X
	G	ISO/L2	X
		(1)	X
0 Up to 10 kg (22 lb.) (0 - 9 months)	E	ISO/R1	IL1
		(1)	X
0+ Up to 13 kg (28 lb.) (0 - 2 years)	E	ISO/R1	IL1
	D	ISO/R2	IL1
	C	ISO/R3	IL1
		(1)	X
I 9 to 18 kg (20 to 39 lb.) (9 months - 4 years)	D	ISO/R2	X
	C	ISO/R3	X
	B	ISO/F2	IUF*, IL2*
	B1	ISO/F2X	IUF*, IL2*
	A	ISO/F3	IUF*, IL2*
		(1)	X
II, III 15 to 36 kg (34 to 79 lb.) (4 - 12 years)		(1)	X

(1) For the child restraint system which do not carry the ISO/XX size class identification (A to G), for the applicable mass group, the car manufacturer shall indicate the vehicle specific ISOFIX child restraint system(s) recommended for each position.

Key of letters inserted in the above table:

IUF: Suitable for ISOFIX forward-facing child restraint systems of universal category approved for use in this mass group.

IL1: Suitable for "TOYOTA MINI with BASE" (0 to 13 kg [0 to 28 lb.]) and "TOYOTA MIDI" (0 to 13 kg [0 to 28 lb.]) approved for the use in this mass group.

IL2: Suitable for "TOYOTA MIDI" (9 to 18 kg [20 to 39 lb.]) approved for the use in this mass group.

When using a "TOYOTA MINI" or "TOYOTA MIDI", adjust the support leg and ISOFIX connectors as follows:

► 7-passengers models

- ① Lock the support leg where 4th hole can be seen.
- ② Lock the ISOFIX connectors where number 4 can be seen.

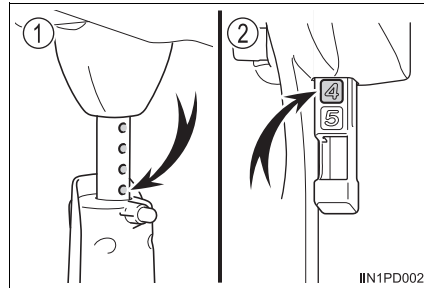

► 5-passengers models

- ① Lock the support leg where 4th hole can be seen.
- ② Lock the ISOFIX connectors where number 2 can be seen.

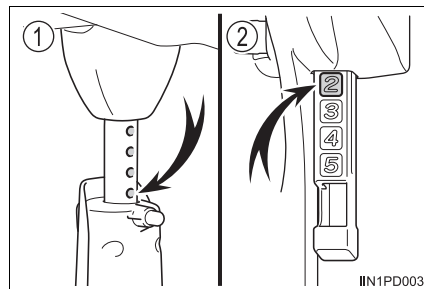

X: ISOFIX position not suitable for ISOFIX child restraint systems in this mass group and/or this size class.

*: If the head restraint interferes with your child restraint system, and the head restraint can be removed, remove the head restraint.

The child restraint systems mentioned in the table may not be available outside of the EU area.

Other child restraint systems different from the systems mentioned in the table can be used, but the suitability of the systems must be carefully checked with the child restraint system manufacturer and retailer.

■ When installing a child restraint system on the front passenger seat

When you have to use a child restraint system on the front passenger seat, adjust the following:

- The seatback to the most upright position
- The seat cushion to the fully rearward position

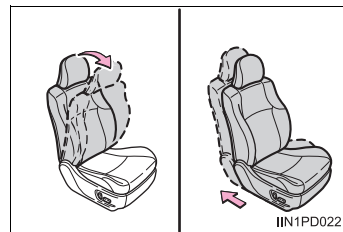

■ Selecting an appropriate child restraint system

- Use a child restraint system appropriate for the child until the child becomes large enough to properly wear the vehicle's seat belt.
- If the child is too large for a child restraint system, sit the child on a rear seat and use the vehicle's seat belt. (→P. 37)

⚠ CAUTION

■ Using a child restraint system

The use of a child restraint system not suitable for the vehicle may not properly secure the infant or child. It may result in death or serious injury (in the event of sudden braking, sudden swerving or an accident).

■ Child restraint precautions

- For effective protection in automobile accidents and sudden stops, a child must be properly restrained, using a seat belt or child restraint system depending on the age and size of the child. Holding a child in your arms is not a substitute for a child restraint system. In an accident, the child can be crushed against the windshield, or between you and the vehicle's interior.
- Toyota strongly urges the use of a proper child restraint system that conforms to the size of the child, installed on the rear seat. According to accident statistics, the child is safer when properly restrained in the rear seat than in the front seat.

 CAUTION**■ Child restraint precautions**

- Vehicles without airbag manual on-off switch: Never install a rear-facing child restraint system on the front passenger seat.
In the event of an accident, the force of the rapid inflation of the front passenger airbag can cause death or serious injury to the child.

Vehicles with airbag manual on-off switch: Never install a rear-facing child restraint system on the front passenger seat when the airbag manual on-off switch is on. (→P. 55)

In the event of an accident, the force of the rapid inflation of the front passenger airbag can cause death or serious injury to the child.

- A forward-facing child restraint system may be installed on the front passenger seat only when it is unavoidable. Always move the seat as far back as possible, because the front passenger airbag could inflate with considerable speed and force. Otherwise, the child may be killed or seriously injured.
- Do not allow the child to lean his/her head or any part of his/her body against the door or the area of the seat, front, center and rear pillars or roof side rail from which the SRS side airbags or SRS curtain shield airbags deploy even if the child is seated in the child restraint system. It is dangerous if the SRS side airbags and curtain shield airbags inflate, and the impact could cause death or serious injury to the child.
- Make sure you have complied with all installation instructions provided by the child restraint manufacturer and that the system is properly secured. If it is not secured properly, it may cause death or serious injury to the child in the event of a sudden stop, sudden swerve or accident.

■ When children are in the vehicle

Do not allow children to play with the seat belt. If the seat belt becomes twisted around a child's neck, it may lead to choking or other serious injuries that could result in death.

If this occurs and the buckle cannot be unfastened, scissors should be used to cut the belt.

■ When the child restraint system is not in use

- Keep the child restraint system properly secured on the seat even if it is not in use. Do not store the child restraint system unsecured in the passenger compartment.
- If it is necessary to detach the child restraint system, remove it from the vehicle or store it securely in the luggage compartment. This will prevent it from injuring passengers in the event of a sudden stop, sudden swerve or accident.

Installing child restraints

Follow the child restraint system manufacturer's instructions. Firmly secure child restraints to the seats using a seat belt or ISOFIX rigid anchors. Attach the top strap when installing a child restraint.

Seat belts (An ELR belt requires a locking clip)

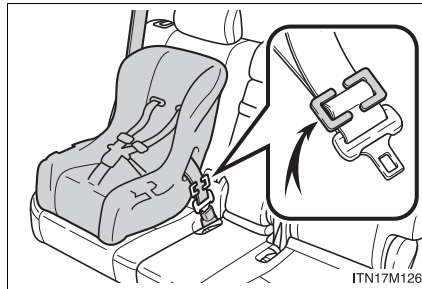

Vehicles for Ukraine, Kazakhstan, Azerbaijan and Georgia: Seat belts equipped with a child restraint locking mechanism (ALR/ELR belts on the outboard second seats)

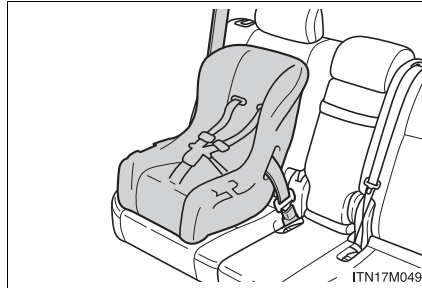

ISOFIX rigid anchors (ISOFIX child restraint system)

Lower anchors are provided for the outboard second seats. (Tags displaying the location of the anchors are attached to the seats.)

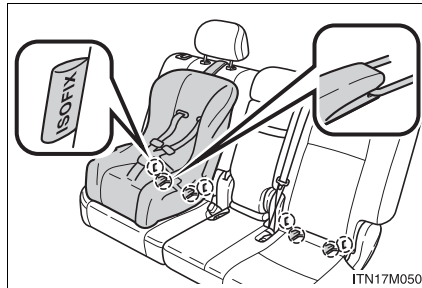

Anchor brackets (for the top strap)

An anchor bracket is provided for each second seat.

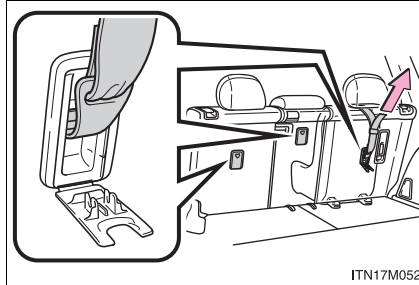

Installing child restraints using a seat belt (child restraint lock function belt)

■ Rear-facing — Baby seat/child seat

① Adjust the seats as follows:

▶ 3-door models

Fold the seatback forward and then back to the 1st lock position (most upright position) until it locks into place. Adjust the seatback to the 5th lock position. (→P. 173)

① 1st lock position

② 5th lock position

▶ 5-door models

Fold the seatback forward. Then return the seatback and secure it at the first lock position (most upright position). (→P. 173)

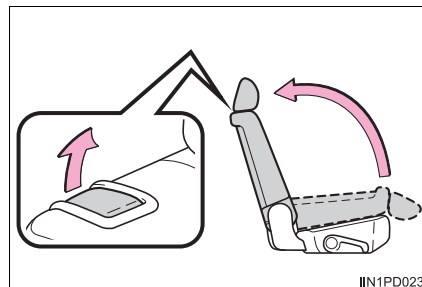
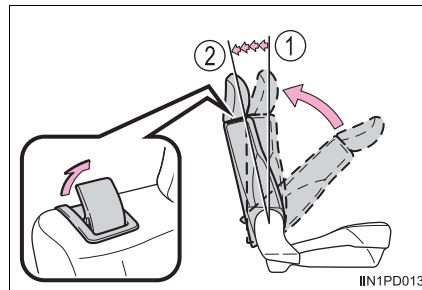

- 2 Place the child restraint system on the second seat facing the rear of the vehicle.

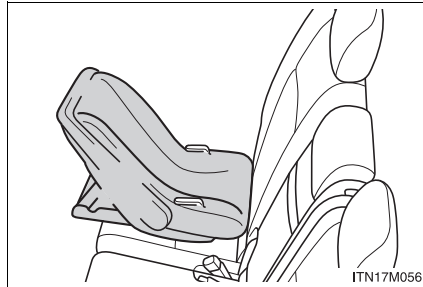

- 3 Run the seat belt through the child restraint system and insert the plate into the buckle. Make sure that the belt is not twisted.

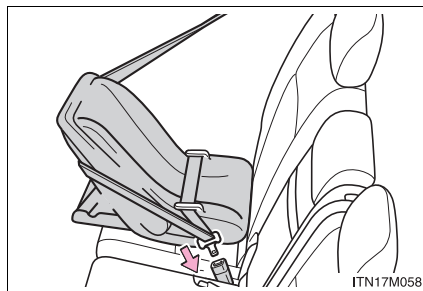

■ Forward-facing — Child seat

- 1 Adjust the seats as follows:

► 3-door models

Fold the seatback forward and then back to the 1st lock position (most upright position) until it locks into place. Adjust the seatback to the 5th lock position. (→P. 173)

- ① 1st lock position
② 5th lock position

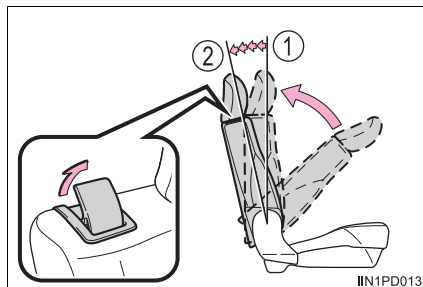

► 5-door models

Fold the seatback forward. Then return the seatback and secure it at the first lock position (most upright position). (→P. 173)

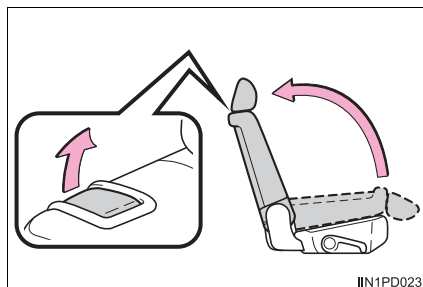

- 2 Place the child restraint system on the seat facing the front of the vehicle.

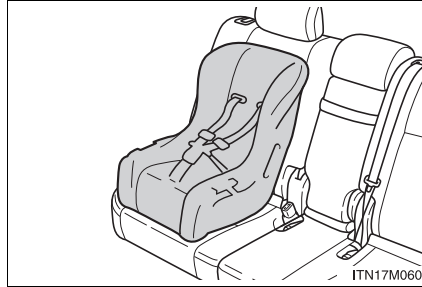

- 3 Run the seat belt through the child restraint system and insert the plate into the buckle. Make sure that the belt is not twisted.

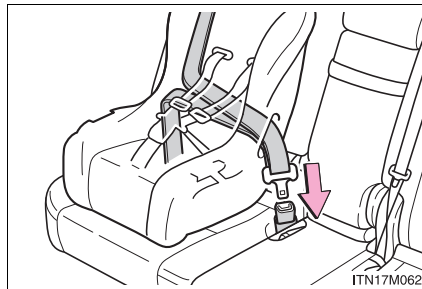

- 4 Fully extend the shoulder belt and allow it to retract to put it in lock mode. In lock mode, the belt cannot be extended.

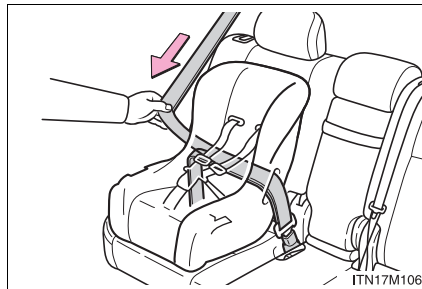

- 5 While pushing the child restraint system into the second seat, allow the shoulder belt to retract until the child restraint system is securely in place.

After the shoulder belt has retracted to a point where there is no slack in the belt, pull the belt to check that it cannot be extended.

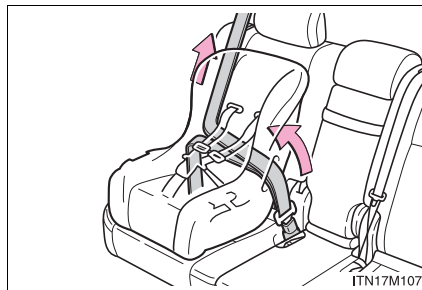

■ Junior seat

1 Adjust the seats as follows:

▶ 3-door models

Fold the seatback forward and then back to the 1st lock position (most upright position) until it locks into place. Adjust the seatback to the 5th lock position. (→P. 173)

① 1st lock position

② 5th lock position

▶ 5-door models

Fold the seatback forward. Then return the seatback and secure it at the first lock position (most upright position). (→P. 173)

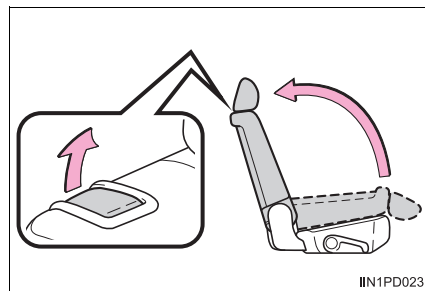
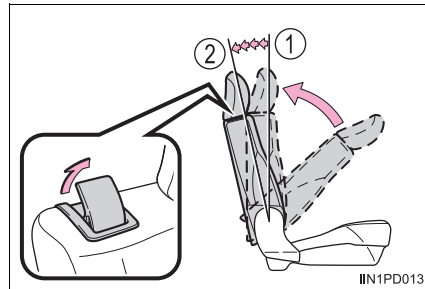

2 Place the child restraint system on the seat facing the front of the vehicle.

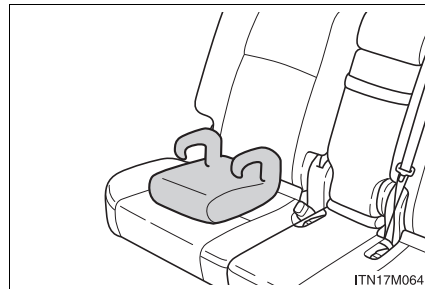

- 3 Sit the child in the child restraint system. Fit the seat belt to the child restraint system according to the manufacturer's instructions and insert the plate into the buckle. Make sure that the belt is not twisted.

Check that the shoulder belt is correctly positioned over the child's shoulder, and that the lap belt is as low as possible.

(→P. 37)



Removing a child restraint installed with a seat belt

Push the buckle release button and fully retract the seat belt.

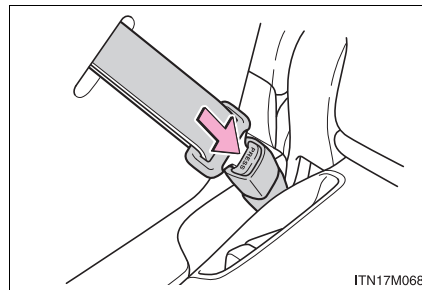

Installation with ISOFIX rigid anchors (ISOFIX child restraint system)

1 Adjust the seats as follows:

► 3-door models

Fold the seatback forward and then back to the 1st lock position (most upright position) until it locks into place. Adjust the seatback to the 5th lock position.

(→P. 173)

① 1st lock position

② 5th lock position

► 5-door models

Fold the seatback forward. Then return the seatback and secure it at the first lock position (most upright position). (→P. 173)

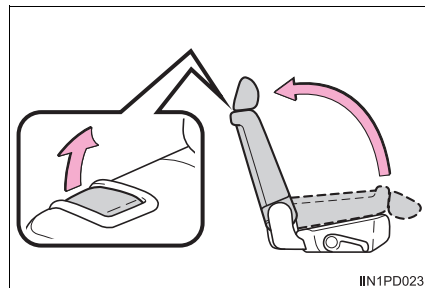
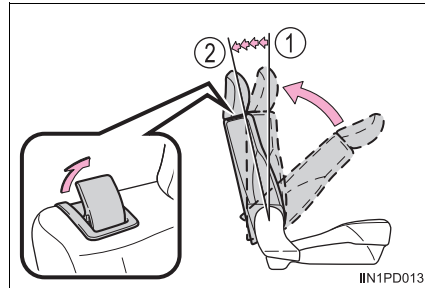

2 Flip the cover (3-door models and 5-door models with third power/manual seats), and latch the buckles onto the exclusive fixing bars.

If the child restraint has a top strap, the top strap should be latched onto the anchor bracket.

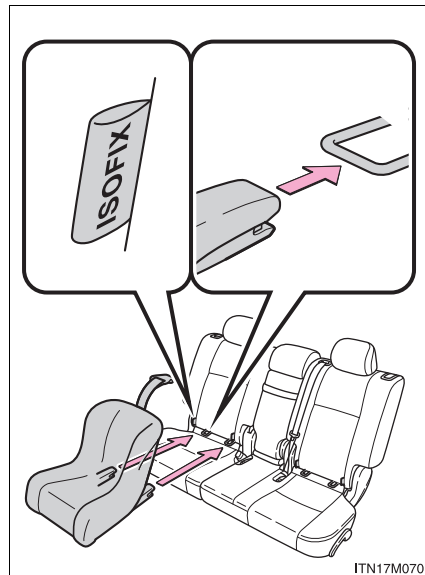

Child restraint systems with a top strap

- 1 Secure the child restraint system using a seat belt or ISOFIX rigid anchors, and move the head restraint in place at the utmost position.

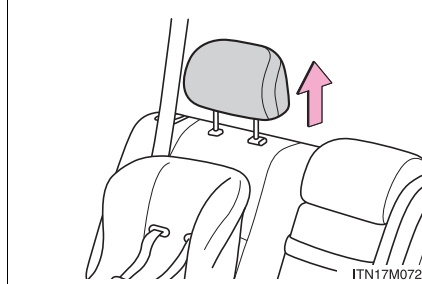

- 2 Open the anchor bracket cover, latch the hook onto the anchor bracket and tighten the top strap.

Make sure the top strap is securely latched.

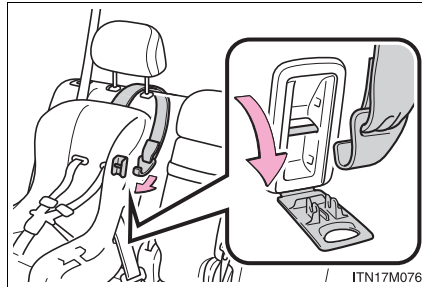

■ When installing a child restraint system in the seat with ELR belt (→P. 71)

You need a locking clip to install the child restraint system. Follow the instructions provided by the manufacturer of the system. If your child restraint system does not provide a locking clip, you can purchase the following item from any authorized Toyota dealer or repairer, or another duly qualified and equipped professional:

Locking clip for child restraint system
(Part No. 73119-22010)

 CAUTION

■ **When installing a junior seat on an outboard second seat (vehicles for Ukraine, Kazakhstan, Azerbaijan and Georgia)**

To prevent the belt from going into ALR lock mode, do not fully extend the shoulder belt. ALR mode causes the belt to tighten only. This could cause injury or discomfort to the child. (→P. 39)

■ **When installing a child restraint system**

Follow the directions given in the child restraint system installation manual and fix the child restraint system securely in place.

If the child restraint system is not correctly fixed in place, the child or other passengers may be seriously injured or even killed in the event of sudden braking, sudden swerving or an accident.

- If the driver's seat interferes with the child restraint system and prevents it from being attached correctly, attach the child restraint system to the right-hand second seat (left-hand drive vehicles) or the left-hand second seat (right-hand drive vehicles).

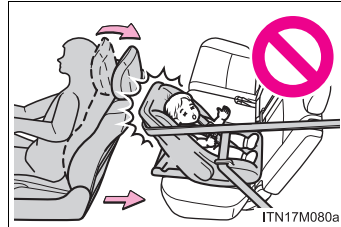

- Adjust the front passenger seat so that it does not interfere with the child restraint system.

- Child restraint system installed on the third seat should not contact the second seatbacks.

- Vehicles without an airbag manual on-off switch: Only put a forward facing child restraint system on the front seat when unavoidable.

When installing a forward-facing child restraint system on the front passenger seat, move the seat as far back as possible. Failing to do so may result in death or serious injury if the airbags deploy (inflate).

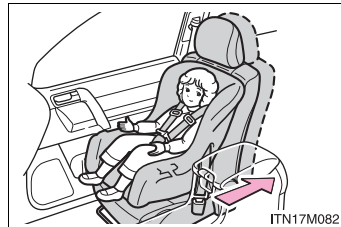

⚠ CAUTION

■ When installing a child restraint system

- Vehicles without an airbag manual on-off switch: Never install a rear-facing child restraint system on the front passenger seat.

The force of the rapid inflation of the front passenger airbag can cause death or serious injury to children in the event of an accident.

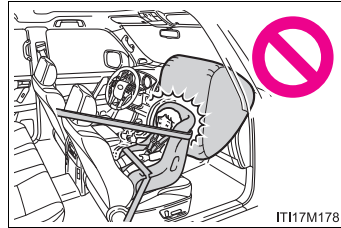

- Vehicles with an airbag manual on-off switch: Never install a rear-facing child restraint system on the front passenger seat when the airbag manual on-off switch is on. (→P. 55)

The force of the rapid inflation of the front passenger airbag can cause death or serious injury to children in the event of an accident.

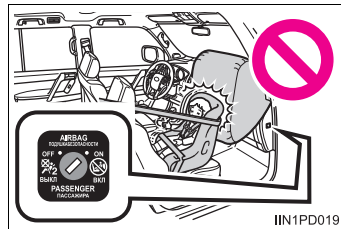

- On some models: There is a label(s) on the passenger side sun visor, indicating it is forbidden to attach a rear-facing child restraint system to the front passenger seat.

Details of the label(s) are shown in the illustration below.

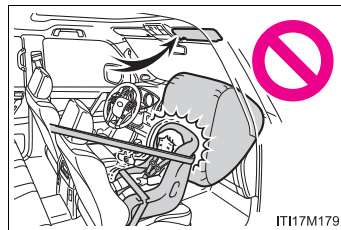

IT117H118a

 CAUTION

■ **When installing a child restraint system**

- If child restraint system regulations exist in the country where you reside, please contact any authorized Toyota dealer or repairer, or another duly qualified and equipped professional for the child restraint system installation.
- When installing a child restraint system on the second center seat, adjust both seat cushions to the same position (vehicles with third manual/power seats) and align both seatbacks at the same angle. The seatbacks must be adjusted to the same angle. Otherwise, the child restraint system cannot be securely restrained and this may cause death or serious injuries in the event of sudden braking, sudden swerving or an accident.
- When a junior seat is installed, always ensure that the shoulder belt is positioned across the center of the child's shoulder. The belt should be kept away from the child's neck, but not so that it could fall off the child's shoulder. Failing to do so may result in death or serious injury in the event of sudden braking, sudden swerving or an accident.
- Ensure that the belt and plate are securely locked and the seat belt is not twisted.
- Shake the child restraint system left and right, and forward and backward to ensure that it has been securely installed.
- After securing a child restraint system, never adjust the seat.
- Follow all installation instructions provided by the child restraint system manufacturer.

- When using the left-hand second seat (left-hand drive vehicles) or right-hand second seat (right-hand drive vehicles) for the child restraint system, do not sit in the center second seat.

Seat belt function may be impaired, such as being positioned overly high or loose-fitting, which may result in death or serious injury in the event of sudden braking, sudden swerving or an accident.

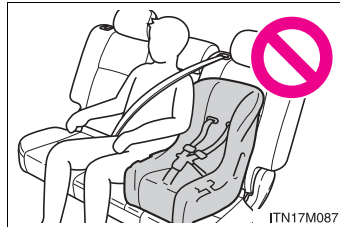

■ **To correctly attach a child restraint system to the anchors**

When using the lower anchors, be sure that there are no foreign objects around the anchors and that the seat belt is not caught behind the child restraint system. Make sure the child restraint system is securely attached, or it may cause death or serious injury to the child or other passengers in the event of a sudden stop, sudden swerve or accident.

Exhaust gas precautions

Harmful substance to the human body is included in exhaust gases if inhale.

CAUTION

Exhaust gases include harmful carbon monoxide (CO), which is colorless and odorless. Observe the following precautions.

Failure to do so may cause exhaust gases enter the vehicle and may lead to an accident caused by light-headedness, or may lead to death or a serious health hazard.

■ Important points while driving

- Keep the back door closed.
- If you smell exhaust gases in the vehicle even when the back door is closed, open the windows and have the vehicle inspected at any authorized Toyota dealer or repairer, or another duly qualified and equipped professional as soon as possible.

■ When parking

- If the vehicle is in a poorly ventilated area or a closed area, such as a garage, stop the engine.
- Do not leave the vehicle with the engine running for a long time.
If such a situation cannot be avoided, park the vehicle in an open space and ensure that exhaust fumes do not enter the vehicle interior.
- Do not leave the engine running in an area with snow build-up, or where it is snowing. If snowbanks build up around the vehicle while the engine is running, exhaust gases may collect and enter the vehicle.

■ Exhaust pipe

The exhaust system needs to be checked periodically. If there is a hole or crack caused by corrosion, damage to a joint or abnormal exhaust noise, be sure to have the vehicle inspected and repaired by any authorized Toyota dealer or repairer, or another duly qualified and equipped professional.

Engine immobilizer system

The vehicle's keys have built-in transponder chips that prevent the engine from starting if a key has not been previously registered in the vehicle's on-board computer.

Never leave the keys inside the vehicle when you leave the vehicle.

► Vehicles without a smart entry & start system

The indicator light flashes after the key has been removed from the engine switch to indicate that the system is operating.

The indicator light stops flashing after the registered key has been inserted into the engine switch to indicate that the system has been canceled.

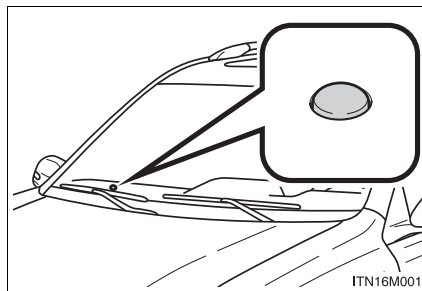

► Vehicles with a smart entry & start system

The indicator light flashes after the engine switch has been turned off to indicate that the system is operating.

The indicator light stops flashing after the engine switch has been turned to ACCESSORY or IGNITION ON mode to indicate that the system has been canceled.

■ System maintenance

The vehicle has a maintenance-free type engine immobilizer system.

■ Conditions that may cause the system to malfunction

- If the grip portion of the key is in contact with a metallic object
- If the key is in close proximity to or touching a key to the security system (key with a built-in transponder chip) of another vehicle

■ Certifications for the engine immobilizer system**▶ Vehicles without a smart entry & start system**

Hereby, Tokai Rika Co., Ltd., declares that this RI-33BTY is in compliance with the essential requirements and other relevant provisions of Directive 1999/5/EC.

The DECLARATION of CONFORMITY (DoC) is available at the following address:

<http://www.tokai-rika.co.jp/pc/>



<p>Hereby, Tokai Rika Co., Ltd., declares that this RI-33BTY is in compliance with the essential requirements and other relevant provisions of Directive 1999/5/EC.</p>
<p>Tokai Rika Co., Ltd. vakuuttaa täten että RI-33BTY tyyppinen laite on direktiivin 1999/5/EY oleellisten vaatimusten ja sitä koskevien direktiivin muiden ehtojen mukainen.</p>
<p>Hierbij verklaart Tokai Rika Co., Ltd. dat het toestel RI-33BTY in overeenstemming is met de essentiële eisen en de andere relevante bepalingen van richtlijn 1999/5/EG.</p>
<p>Par la présente Tokai Rika Co., Ltd. déclare que l'appareil RI-33BTY est conforme aux exigences essentielles et aux autres dispositions pertinentes de la directive 1999/5/CE.</p>
<p>Härmed intygar Tokai Rika Co., Ltd. att denna RI-33BTY står i överensstämmelse med de väsentliga egenskapskrav och övriga relevanta bestämmelser som framgår av direktiv 1999/5/EG.</p>
<p>Undertegnede Tokai Rika Co., Ltd. erklærer herved, at følgende udstyr RI-33BTY overholder de væsentlige krav og øvrige relevante krav i direktiv 1999/5/EF.</p>
<p>Hiermit erklärt Tokai Rika Co., Ltd., dass sich das Gerät RI-33BTY in Übereinstimmung mit den grundlegenden Anforderungen und den übrigen einschlägigen Bestimmungen der Richtlinie 1999/5/EG befindet.</p>
<p>ΜΕ ΤΗΝ ΠΑΡΟΥΣΑ Tokai Rika Co., Ltd. ΔΗΛΩΝΕΙ ΟΤΙ RI-33BTY ΣΥΜΜΟΡΦΩΝΕΤΑΙ ΠΡΟΣ ΤΙΣ ΟΥΣΙΩΔΕΙΣ ΑΠΑΙΤΗΣΕΙΣ ΚΑΙ ΤΙΣ ΛΟΙΠΕΣ ΣΧΕΤΙΚΕΣ ΔΙΑΤΑΞΕΙΣ ΤΗΣ ΟΔΗΓΙΑΣ 1999/5/ΕΚ.</p>
<p>Con la presente Tokai Rika Co., Ltd. dichiara che questo RI-33BTY è conforme ai requisiti essenziali ed alle altre disposizioni pertinenti stabilite dalla direttiva 1999/5/CE.</p>
<p>Por medio de la presente Tokai Rika Co., Ltd. declara que el RI-33BTY cumple con los requisitos esenciales y cualesquiera otras disposiciones aplicables o exigibles de la Directiva 1999/5/CE.</p>
<p>Tokai Rika Co., Ltd. declara que este RI-33BTY está conforme com os requisitos essenciais e outras disposições da Directiva 1999/5/CE.</p>
<p>Hawnhekk, Tokai Rika Co., Ltd., jiddikjara li dan RI-33BTY jikkonforma mal-htigijiet essenzjali u ma provvedimenti oħrajn relevanti li hemm fid-Dirrettiva 1999/5/EC.</p>
<p>Käesolevaga kinnitab Tokai Rika Co., Ltd. seadme RI-33BTY vastavust direktiivi 1999/5/EÜ põhinõuetele ja nimetatud direktiivist tulenevatele teistele asjakohastele sätetele.</p>
<p>Alulírott, Tokai Rika Co., Ltd. nyilatkozom, hogy a RI-33BTY megfelel a vonatkozó alapvető követelményeknek és az 1999/5/EC irányelv egyéb előírásainak.</p>

Tokai Rika Co., Ltd. tímto vyhlasuje, že RI-33BTY spĺňa základné požiadavky a všetky príslušné ustanovenia Smernice 1999/5/ES.
Tokai Rika Co., Ltd. tímto prohlašuje, že tento RI-33BTY je ve shodě se základními požadavky a dalšími příslušnými ustanoveními směrnice 1999/5/ES.
Tokai Rika Co., Ltd. izjavlja, da je ta RI-33BTY v skladu z bistvenimi zahtevami in ostalimi relevantnimi določili direktive 1999/5/ES.
Šiuo Tokai Rika Co., Ltd. deklaruoja, kad šis RI-33BTY atitinka esminius reikalavimus ir kitas 1999/5/EB Direktyvos nuostatas.
Ar šo Tokai Rika Co., Ltd. deklarē, ka RI-33BTY atbilst Direktīvas 1999/5/EK būtiskajām prasībām un citiem ar to saistītajiem noteikumiem.
Niniejszym Tokai Rika Co., Ltd. oświadcza, że RI-33BTY jest zgodny z zasadniczymi wymogami oraz pozostałymi stosownymi postanowieniami Dyrektywy 1999/5/EC.
Hér með lýsir Tokai Rika Co., Ltd. yfir því að RI-33BTY er í samræmi við grunnkröfur og aðrar kröfur, sem gerðar eru í tilskipun 1999/5/EC.
Tokai Rika Co., Ltd. erklærer herved at utstyret RI-33BTY er i samsvar med de grunnleggende krav og øvrige relevante krav i direktiv 1999/5/EF.
С настоящето, Tokai Rika Co., Ltd., декларира, че RI-33BTY е в съответствие със съществените изисквания и другите приложими разпоредби на Директива 1999/5/EC.
Prin prezenta, Tokai Rika Co., Ltd., declară că aparatul RI-33BTY este în conformitate cu cerințele esențiale și cu alte prevederi pertinente ale Directivei 1999/5/CE.
Ovim, Tokai Rika Co., Ltd., izjavlja da ovaj RI-33BTY je usklađen sa bitnim zahtjevima i drugim relevantnim odredbama Direktive 1999/5/EC.
Nepermjet kesaj, Tokai Rika Co., Ltd., deklaroi qe ky RI-33BTY eshte ne pajtim me kerkesat thelbesore dhe dispozitat e tjera perkatese te Direktives 1999/5/EC.
Ovim Tokai Rika Co., Ltd., izjavjuje da je RI-33BTY u skladu s bitnim zahtjevima i drugim relevantnim odredbama Direktive 1999/5/EC i Pravilnika o RiTT opremi (NN 25/2012).
Ovim, Tokai Rika Co., Ltd., deklarirše da je RI-33BTY u skladu sa osnovnim zahtevima i ostalim relevantnim odredbama Direktive 1999/5/EC.

► Vehicles with a smart entry & start system

Hereby, Toyota Motor Corporation, declares that this TMIMB-2 is in compliance with the essential requirements and other relevant provisions of Directive 1999/5/EC.

TOYOTA

TOYOTA MOTOR CORPORATION

1, TOYOTA-CHO, TOYOTA, AICHI, 471-8571, JAPAN TEL:+81-565-28-2121

R&TTE Declaration of Conformity

We,

Manufacturer's Name: TOYOTA MOTOR CORPORATION

Manufacturer's Address: 1, Toyota -cho, Toyota, Aichi, 471-8572, Japan

hereby declare under our sole responsibility that the product:

Product Name: Immobilizer

Product Model: TMIMB-2

to which this declaration relates is in conformity with the essential requirements and other relevant requirements of the R&TTE Directive (1999/5/EC). The product is compliant with the following standards and/or other normative documents:

-Health & safety requirements:	EN 60950-1
-EMC requirements	EN 301 489-01 & EN 301 489-03
-Effective uses of radio spectrum:	EN 300 330-2

Supplementary information:

* CE mark	
* Member states intended for use	EU and EFTA

Date: February 25, 2013

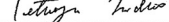
Signature: 
Tetsuya Matsuo

Hereby, Toyota Motor Corporation, declares that this TMIMB-2 is in compliance with the essential requirements and other relevant provisions of Directive 1999/5/EC.
Toyota Motor Corporation vakuuttaa täten että TMIMB-2 tyyppinen laite on direktiivin 1999/5/EY oleellisten vaatimusten ja sitä koskevien direktiivin muiden ehtojen mukainen.
Hierbij verklaart Toyota Motor Corporation dat het toestel TMIMB-2 in overeenstemming is met de essentiële eisen en de andere relevante bepalingen van richtlijn 1999/5/EG.
Par la présente Toyota Motor Corporation déclare que l'appareil TMIMB-2 est conforme aux exigences essentielles et aux autres dispositions pertinentes de la directive 1999/5/CE.
Härmed intygar Toyota Motor Corporation att denna TMIMB-2 står i överensstämmelse med de väsentliga egenskapskrav och övriga relevanta bestämmelser som framgår av direktiv 1999/5/EG.
Undertegnede Toyota Motor Corporation erklærer herved, at følgende udstyr TMIMB-2 overholder de væsentlige krav og øvrige relevante krav i direktiv 1999/5/EF.
Hiermit erklärt Toyota Motor Corporation, dass sich das Gerät TMIMB-2 in Übereinstimmung mit den grundlegenden Anforderungen und den übrigen einschlägigen Bestimmungen der Richtlinie 1999/5/EG befindet.
ΜΕ ΤΗΝ ΠΑΡΟΥΣΑ Toyota Motor Corporation ΔΗΛΩΝΕΙ ΟΤΙ ΤΜΙΜΒ-2 ΣΥΜΜΟΡΦΩΝΕΤΑΙ ΠΡΟΣ ΤΙΣ ΟΥΣΙΩΔΕΙΣ ΑΠΑΙΤΗΣΕΙΣ ΚΑΙ ΤΙΣ ΛΟΙΠΕΣ ΣΧΕΤΙΚΕΣ ΔΙΑΤΑΞΕΙΣ ΤΗΣ ΟΔΗΓΙΑΣ 1999/5/ΕΚ.
Con la presente Toyota Motor Corporation dichiara che questo TMIMB-2 è conforme ai requisiti essenziali ed alle altre disposizioni pertinenti stabilite dalla direttiva 1999/5/CE.
Por medio de la presente Toyota Motor Corporation declara que el TMIMB-2 cumple con los requisitos esenciales y cualesquiera otras disposiciones aplicables o exigibles de la Directiva 1999/5/CE.
Toyota Motor Corporation declara que este TMIMB-2 está conforme com os requisitos essenciais e outras disposições da Directiva 1999/5/CE.
Hawnhekk, Toyota Motor Corporation, jiddikjara li dan TMIMB-2 jikkonforma mal-htigijiet essenzjali u ma provvedimenti oħrajn relevanti li hemm fid-Dirrettiva 1999/5/EC.
Käesolevaga kinnitab Toyota Motor Corporation seadme TMIMB-2 vastavust direktiivi 1999/5/EÜ põhinõuetele ja nimetatud direktiivist tulenevatele teistele asjakohastele sätetele.
Alulírott, Toyota Motor Corporation nyilatkozom, hogy a TMIMB-2 megfelel a vonatkozó alapvető követelményeknek és az 1999/5/EC irányelv egyéb előírásainak.

<p>Toyota Motor Corporation týmto vyhlasuje, že TMIMB-2 spĺňa základné požiadavky a všetky príslušné ustanovenia Smernice 1999/5/ES.</p>
<p>Toyota Motor Corporation tímto prohlašuje, že tento TMIMB-2 je ve shodě se základními požadavky a dalšími příslušnými ustanoveními směrnice 1999/5/ES.</p>
<p>Toyota Motor Corporation izjavlja, da je ta TMIMB-2 v skladu z bistvenimi zahtevami in ostalimi relevantnimi določili direktive 1999/5/ES.</p>
<p>Šiuo Toyota Motor Corporation deklaruoja, kad šis TMIMB-2 atitinka esminius reikalavimus ir kitas 1999/5/EB Direktyvos nuostatas.</p>
<p>Ar šo Toyota Motor Corporation deklarē, ka TMIMB-2 atbilst Direktīvas 1999/5/EK būtiskajām prasībām un citiem ar to saistītajiem noteikumiem.</p>
<p>Niniejszym Toyota Motor Corporation oświadcza, że TMIMB-2 jest zgodny z zasadniczymi wymogami oraz pozostałymi stosownymi postanowieniami Dyrektywy 1999/5/EC.</p>
<p>Hér með lýsir Toyota Motor Corporation yfir því að TMIMB-2 er í samræmi við grunnkröfur og aðrar kröfur, sem gerðar eru í tilskipun 1999/5/EC.</p>
<p>Toyota Motor Corporation erklærer herved at utstyret TMIMB-2 er i samsvar med de grunnleggende krav og øvrige relevante krav i direktiv 1999/5/EF.</p>
<p>С настоящето, Toyota Motor Corporation, декларира, че TMIMB-2 е в съответствие със съществените изисквания и другите приложими разпоредби на Директива 1999/5/EC.</p>
<p>Prin prezenta, Toyota Motor Corporation, declară că aparatul TMIMB-2 este în conformitate cu cerințele esențiale și cu alte prevederi pertinente ale Directivei 1999/5/CE.</p>
<p>Ovim, Toyota Motor Corporation, izjavljuje da ovaj TMIMB-2 je usklađen sa bitnim zahtjevima i drugim relevantnim odredbama Direktive 1999/5/EC.</p>
<p>Nepermjet kesaj, Toyota Motor Corporation, deklaroj qe ky TMIMB-2 eshte ne pajtim me kerkesat thelbesore dhe dispozitat e tjera perkatese te Direktives 1999/5/EC.</p>
<p>Ovim Toyota Motor Corporation, izjavljuje da je TMIMB-2 u skladu s bitnim zahtjevima i drugim relevantnim odredbama Direktive 1999/5/EC i Pravilnika o RITT opremi (NN 25/2012).</p>
<p>Ovim, Toyota Motor Corporation, deklarirše da je TMIMB-2 u skladu sa osnovnim zahtevima i ostalim relevantnim odredbama Direktive 1999/5/EC.</p>

**NOTICE****■ To ensure the system operates correctly**

Do not modify or remove the system. If modified or removed, the proper operation of the system cannot be guaranteed.

Double locking system*

Unauthorized access to the vehicle is prevented by disabling the door unlocking function from both the interior and exterior of the vehicle.

Vehicles employing this system have labels on the window glass of both front doors.

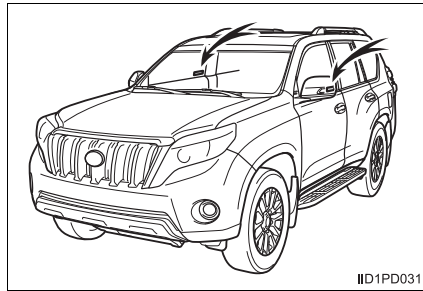

Setting the double locking system

Turn the engine switch off, have all the passengers exit the vehicle and ensure that all the doors are closed.

Using the entry function (vehicles with a smart entry & start system):
Touch the sensor area on the front outside door handles twice within 5 seconds.

Using the wireless remote control:
Press  twice within 5 seconds.

Canceling the double locking system

Using the entry function (vehicles with a smart entry & start system):
Hold the outside door handle on the driver's side.

Using the wireless remote control: Press  .

CAUTION

■ Double locking system precaution

Never activate the double locking system when there are people in the vehicle because all the doors cannot be opened from inside the vehicle.

*: If equipped

Alarm*

The alarm

The alarm uses light and sound to give an alert when an intrusion is detected.

The alarm is triggered in the following situations when the alarm is set:

- A locked door or glass hatch (if equipped) is unlocked or opened in any way other than using the entry function or the wireless remote control. (The doors will lock again automatically.)
- The hood is opened.
- The intrusion sensor detects something moving inside the vehicle. (An intruder gets in the vehicle.) (if equipped)
- The tilt sensor detects a change of vehicle inclination. (vehicles for U.K.)
- The quarter windows (5-door models) or back door window are broken. (if equipped)

Setting the alarm system

Close the doors, glass hatch and hood, and lock all the doors using the entry function or wireless remote control. The system will be set automatically after 30 seconds.

The indicator light changes from being on to flashing when the system is set.

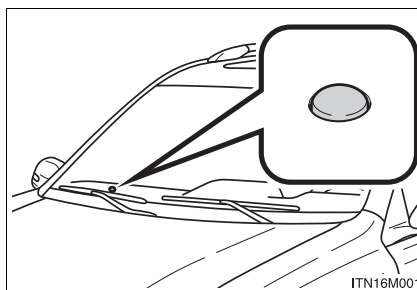

*: If equipped

Deactivating or stopping the alarm

Do one of the following to deactivate or stop the alarm.

- Unlock the doors using the entry function or the wireless remote control.
- Start the engine. (The alarm will be deactivated or stopped after a few seconds.)

■ System maintenance

The vehicle has a maintenance-free type alarm system.

■ Items to check before locking the vehicle

To prevent unexpected triggering of the alarm and vehicle theft, make sure of the following.

- Nobody is in the vehicle.
- The windows and moon roof (if equipped) are closed before the alarm is set.
- No valuables or other personal items are left in the vehicle.

■ Triggering of the alarm

The alarm may be triggered in the following situations:
(Stopping the alarm deactivates the alarm system.)

- The doors are unlocked using the mechanical key.

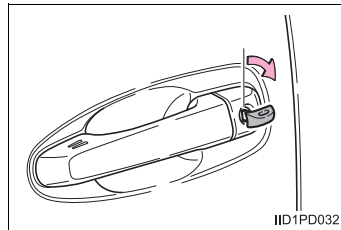

- A person inside the vehicle opens a door or hood.



- The battery is recharged or replaced when the vehicle is locked. (→P. 667)

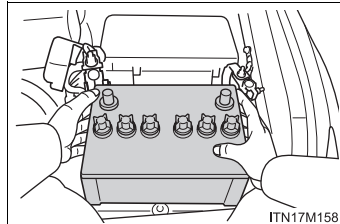

■ Alarm-operated door lock

- When the alarm is operating, the doors are locked automatically to prevent intruders.
- Do not leave the key inside the vehicle when the alarm is operating, and make sure the key is not inside the vehicle when recharging or replacing the battery.

■ Customization

The alarm can be set to deactivate when the mechanical key is used to unlock.

(Customizable features: →P. 705)



NOTICE

■ To ensure the system operates correctly

Do not modify or remove the system. If modified or removed, the proper operation of the system cannot be guaranteed.

Intrusion sensor and tilt sensor (if equipped)

- The intrusion sensor detects intruders or movement in the vehicle.
- The tilt sensor detects changes in vehicle inclination, such as when the vehicle is towed away. (vehicles for U.K.)

This system is designed to deter and prevent vehicle theft but does not guarantee absolute security against all intrusions.

■ Setting the intrusion sensor and tilt sensor

The intrusion sensor and tilt sensor will be set automatically when the alarm is set. (→P. 92)

■ Canceling the intrusion sensor and tilt sensor

If you are leaving pets or other moving things inside the vehicle, make sure to stop the intrusion sensor and tilt sensor before setting the alarm, as they will respond to movement inside the vehicle.

- 1 Turn the engine switch off.
- 2 Press the intrusion sensor and tilt sensor cancel switch.

When the system is canceled, the indicator flashes rapidly.

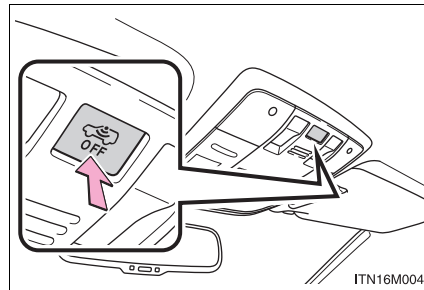

■ Canceling and automatic re-enabling of the intrusion sensor and tilt sensor (if equipped)

- The alarm will still be set even when the intrusion sensor and tilt sensor are canceled.
- After the intrusion sensor and tilt sensor are canceled, pressing the engine switch or unlocking the doors using the entry function or wireless remote control will re-enable the intrusion sensor and tilt sensor.
- The intrusion sensor and tilt sensor will automatically be re-enabled when the alarm system is deactivated.

■ Intrusion sensor detection considerations (if equipped)

The sensor may trigger the alarm in the following situations:

- A window or the moon roof (if equipped) is open.

In this case, the sensor may detect the following:

- Wind or the movement of objects such as leaves and insects inside the vehicle
- Ultrasonic waves emitted from devices such as the intrusion sensors of other vehicles
- The movement of people outside the vehicle

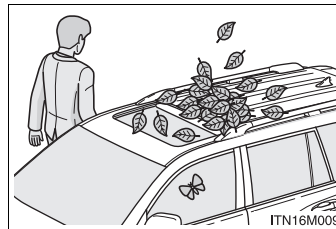

- Unstable items, such as dangling accessories or clothes hanging on the coat hooks, are in the vehicle.

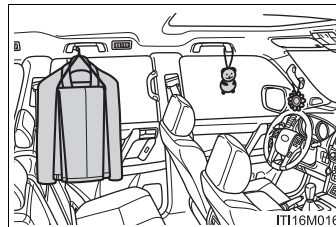

- Places with extreme vibrations or noises, or situations in which the vehicle is subject to repeated impacts or vibrations:

- When parked in a parking garage
- When the vehicle is transported by a ferry, trailer, train, etc.
- When ice adhering to the vehicle is removed
- When the vehicle is in an automatic or high-pressure car wash
- When in a hail or lightning storm

■ Tilt sensor detection considerations (if equipped)

The sensor may trigger the alarm in the following situations:

- The vehicle is transported by a ferry, trailer, train, etc.
- The vehicle is parked in a parking garage.
- The vehicle is inside a car wash that moves the vehicle.
- Any of the tires loses air pressure.
- The vehicle is jacked up.
- An earthquake occurs or the road caves in.
- Cargo is loaded onto or unloaded from the roof luggage carrier.

 NOTICE**■ To ensure the intrusion sensor functions correctly (if equipped)**

- To ensure that the sensors operate properly, do not touch or cover them.

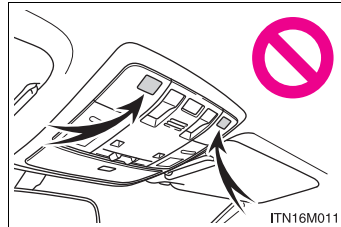

- Do not spray air fresheners or other products directly into the sensor holes.

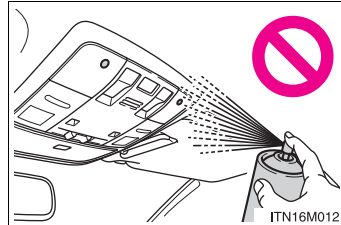

Instrument cluster

2

2. Instrument cluster

Warning lights and indicators98
Gauges and meters 105
Multi-information display (Type A)..... 109
Multi-information display (Type B)..... 114
Fuel consumption information 122

Warning lights and indicators

The warning lights and indicators on the instrument cluster and center panel inform the driver of the status of the vehicle's various systems.

For the purpose of explanation, the following illustrations display all warning lights and indicators illuminated.

- Vehicles with the multi-information display type A

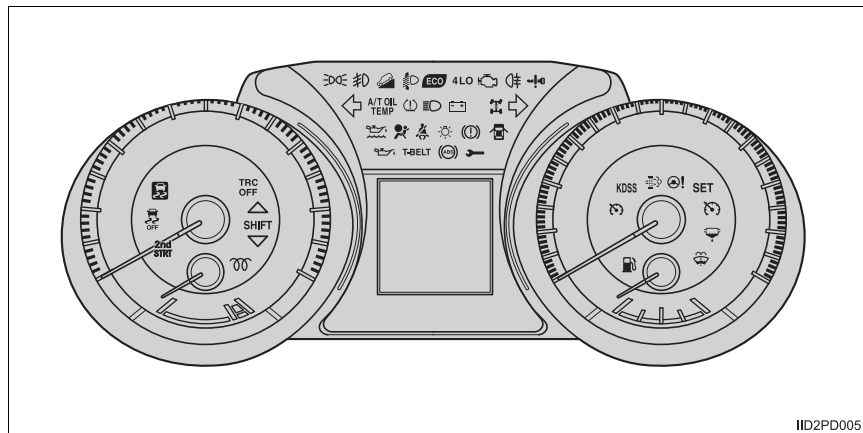



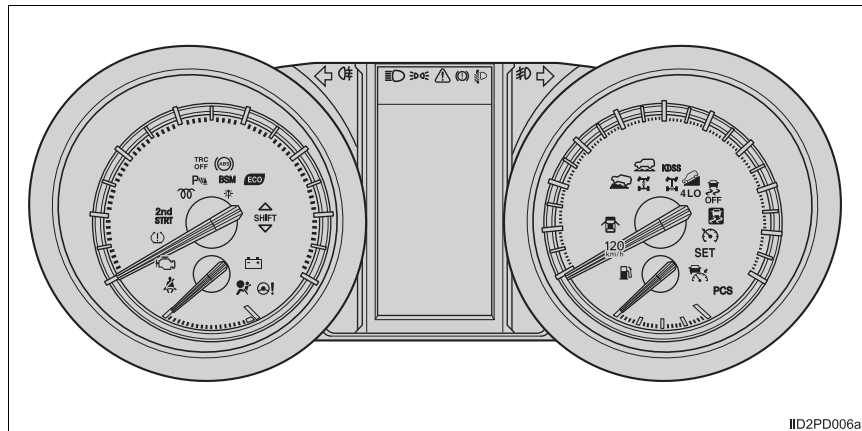













► Vehicles with the multi-information display type B













The units used on the speedometer and some indicators may differ depending on the target region.

Warning lights

Warning lights inform the driver of malfunctions in the indicated vehicle's systems.

<p>^{*1}  (if equipped)</p>	<p>Master warning light (→P. 598)</p>	<p></p>	<p>Open door warning light (→P. 597)</p>
<p>^{*1} </p>	<p>Brake system warning light (→P. 594)</p>	<p></p>	<p>Seat belt reminder light (→P. 597)</p>
<p>^{*1} </p>	<p>Charging system warning light (→P. 594)</p>	<p></p>	<p>Low fuel level warning light (→P. 597)</p>
<p>^{*1}  (if equipped)</p>	<p>Low engine oil pressure warning light (→P. 594)</p>	<p>^{*1}  (if equipped)</p>	<p>Low engine oil level warning light (→P. 598)</p>
<p>^{*1} </p>	<p>Malfunction indicator lamp (→P. 594)</p>	<p>^{*1, 2}  (if equipped)</p>	<p>Automatic transmission fluid temperature warning light (→P. 596)</p>
<p>^{*1} </p>	<p>SRS warning light (→P. 595)</p>	<p>^{*1}  (if equipped)</p>	<p>KDSS warning light (→P. 596)</p>
<p>^{*1} </p>	<p>ABS warning light (→P. 595)</p>	<p>^{*1}  (if equipped)</p>	<p>Timing belt replacement warning light (→P. 596)</p>
<p>^{*1} </p>	<p>Power steering system warning light (→P. 595)</p>	<p>^{*1}  (if equipped)</p>	<p>Fuel filter warning light (→P. 597)</p>
<p>^{*1} </p>	<p>Slip indicator (→P. 596)</p>		

<p>^{*1, 2}  (if equipped)</p>	<p>Pre-crash safety system warning light (→P. 595)</p>	<p>^{*1}  (if equipped)</p>	<p>Tire pressure warning light (→P. 598)</p>
<p>^{*1}  (if equipped)</p>	<p>DPF system warning light (→P. 599)</p>	<p>^{*1}  (if equipped)</p>	<p>Smart entry & start system indicator (→P. 601)</p>
<p>^{*1}  (if equipped)</p>	<p>Engine oil change reminder light (→P. 599)</p>	<p>^{*1}  (if equipped)</p>	<p>Low windshield washer fluid warning light (→P. 598)</p>
<p>^{*1, 3}  (if equipped)</p>	<p>Toyota parking assist-sensor indicator (→P. 599)</p>	<p>^{*1, 2}  (if equipped)</p>	<p>Automatic headlight leveling system warning light (→P. 599)</p>
<p>^{*1}  (if equipped)</p>	<p>LED headlight warning light (→P. 598)</p>	<p>^{*1}  (yellow) (if equipped)</p>	<p>Cruise control indicator (→P. 595)</p>
<p>^{*1}  (if equipped)</p>	<p>Fuel system warning light (→P. 597)</p>		



















^{*1}: These lights turn on when the engine switch is turned to the “ON” position (vehicles without a smart entry & start system) or IGNITION ON mode (vehicles with a smart entry & start system), to indicate that a system check is being performed. They will turn off after the engine is started, or after a few seconds. There may be a malfunction in a system if the lights do not come on, or turn off. Have the vehicle inspected by any authorized Toyota dealer or repairer, or another duly qualified and equipped professional.









^{*2}: The light flashes to indicate a malfunction.

^{*3}: This light illuminates on the center panel.

Indicators

The indicators inform the driver of the operating state of the vehicle's various systems.

^{*1} 	Turn signal indicator (→P. 263)	^{*1} 	"SET" indicator (→P. 292, 296)
	Headlight high beam indicator (→P. 267)	^(if equipped) 	Dynamic radar cruise control indicator (→P. 296)
	Tail light indicator (→P. 267)	^{*1, 2} 	Slip indicator (→P. 361)
	Front fog light indicator (→P. 277)	^(if equipped)	
	Rear fog light indicator (→P. 277)	^{*1, 2} 	VSC OFF indicator (→P. 362)
^(if equipped)			"TRC OFF" indicator (→P. 362)
^(if equipped)		^(if equipped)	
^{*1} 	Eco Driving Indicator Light (→P. 113, 120)		Engine preheating indicator (→P. 243)
^(if equipped)		^(diesel engine)	
^{*1} 	Gear Shift Indicator (→P. 259)	^{*2} 	Multi-terrain Select indicator
^(if equipped)		^(if equipped)	
	Cruise control indicator (→P. 292, 296)	^{*1, 2} 	Crawl Control indicator
^(green)		^(if equipped)	
^(if equipped)			
^{*1, 2} 	Downhill assist control system indicator	^{*1, 6} 	Airbag manual off indicator (→P. 55)
^(if equipped)		^(if equipped)	

- | | | | |
|---|---|---|---|
| 
(automatic transmission) | Automatic transmission second start indicator (→P. 254) | 
(if equipped) | Toyota parking assist-sensor indicator (→P. 312) |
| *2
 | Low speed four-wheel drive indicator light | *1, 3

(if equipped) | Pre-crash safety system warning light (→P. 378) |
| *2

(if equipped) | Rear differential lock indicator | *4, 5

(if equipped) | BSM (Blind Spot Monitor) outside rear view mirror indicator (→P. 366) |
| *2
 | Center differential lock indicator | *1

(if equipped) | “BSM” (Blind Spot Monitor) indicator (→P. 366) |
| *1, 6

(if equipped) | Toyota parking assist-sensor indicator (→P. 314) | | |

2

Instrument cluster

- *1: These lights turn on when the engine switch is turned to the “ON” position (vehicles without a smart entry & start system) or the engine switch is turned to IGNITION ON mode (vehicles with a smart entry & start system) to indicate that a system check is being performed. They will turn off after the engine is started, or after a few seconds. There may be a malfunction in a system if a light does not turn on, or if the lights do not turn off. Have the vehicle inspected by any authorized Toyota dealer or repairer, or another duly qualified and equipped professional.
- *2: Refer to the “Off-road Driving Owner’s Manual”
- *3: The light turns on when pre-crash braking is disabled. The light flashes quickly to indicate that the system is operating.
- *4: In order to confirm operation, the BSM outside rear view mirror indicators illuminate in the following situations:
- When the engine switch is turned to the “ON” position (vehicles without a smart entry & start system) or IGNITION ON mode (vehicles with a smart entry & start system) while the system is set to ON.
 - When the system is set to ON while the engine switch is in the “ON” position (vehicles without a smart entry & start system) or IGNITION ON mode (vehicles with a smart entry & start system).
- If the system is functioning correctly, the BSM outside rear view mirror indicators will turn off after a few seconds.
- If the BSM outside rear view mirror indicators do not illuminate or do not turn off, there may be a malfunction with the system. If this occurs, have the vehicle inspected by any authorized Toyota dealer or repairer, or another duly qualified and equipped professional.
- *5: This light illuminates on the outside rear view mirrors.
- *6: This light illuminates on the center panel.

 CAUTION**■ If a safety system warning light does not turn on**

Should a safety system light such as ABS/Multi Terrain ABS and the SRS warning light not turn on when you start the engine, this could mean that these systems are not available to help protect you in an accident, which could result in death or serious injury. Have the vehicle inspected by any authorized Toyota dealer or repairer, or another duly qualified and equipped professional immediately if this occurs.

Gauges and meters

- Vehicles with the multi-information display type A

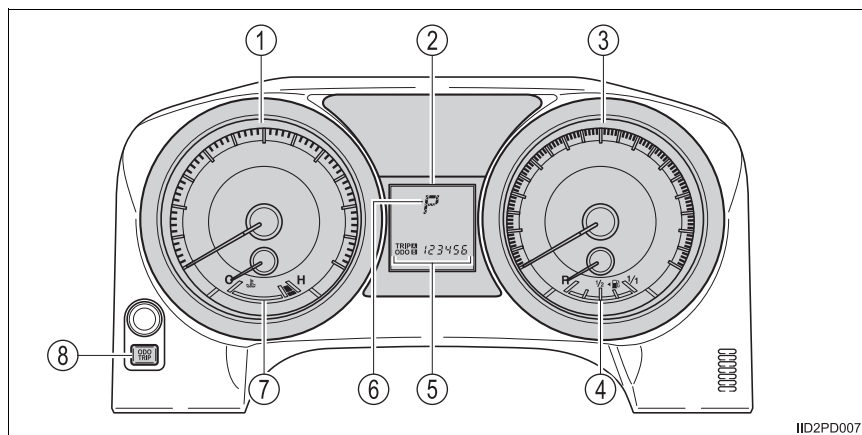

- Vehicles with the multi-information display type B

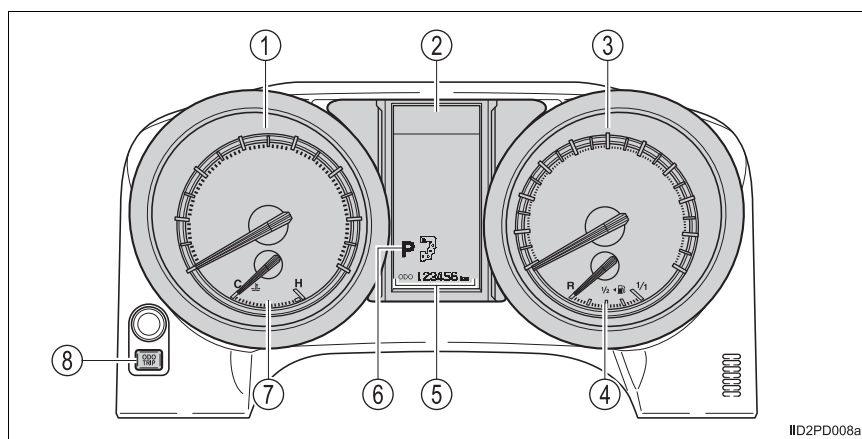

The units used on the speedometer may differ depending on the target region.

- ① Tachometer
Displays the engine speed in revolutions per minute
- ② Multi-information display
Presents the driver with a variety of driving-related data
(→P. 110, 115)
- ③ Speedometer
Displays the vehicle speed
- ④ Fuel gauge
Displays the quantity of fuel remaining in the tank
- ⑤ Odometer and trip meter display
Odometer:
Displays the total distance the vehicle has been driven.
Trip meter:
Displays the distance the vehicle has been driven since the meter was last reset. Trip meters A and B can be used to record and display different distances independently.
- ⑥ Shift position and shift range
Displays the selected shift position or selected shift range
(→P. 251)
- ⑦ Engine coolant temperature gauge
Displays the engine coolant temperature
- ⑧ Odometer/trip meter display change button
→P. 108

Changing the display

- ▶ Vehicles with the multi-information display type A

→P. 110

- ▶ Vehicles with the multi-information display type B

Switches between odometer and trip meter displays. When the trip meter is displayed, pressing and holding the button will reset the trip meter.

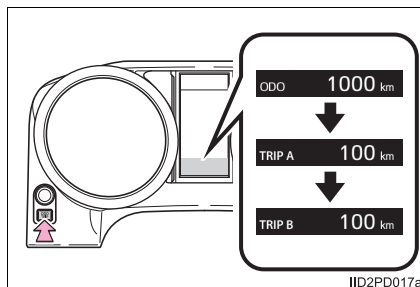

Instrument cluster light control

The brightness of the instrument cluster lights can be adjusted by turning the dial.

- ① Darker
- ② Brighter

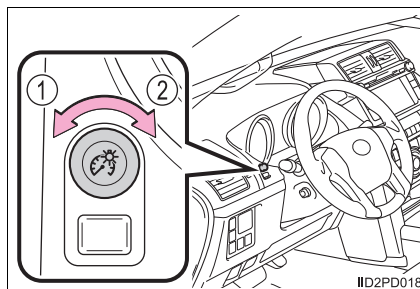

■ **The meters and display illuminate when**

- ▶ Vehicles without a smart entry & start system

The engine switch is in the "ON" position.

- ▶ Vehicles with a smart entry & start system

The engine switch is in IGNITION ON mode.

■ **The brightness of the instrument cluster lights**

- ▶ Vehicles with the multi-information display type A

When the headlight switch is turned to on, the brightness will be reduced slightly.

- ▶ Vehicles with the multi-information display type B

When the headlight switch is turned to on, the brightness will be reduced slightly unless the control dial is turned fully clockwise.

■ **When disconnecting and reconnecting battery terminals**

- ▶ Vehicles with the multi-information display type A

→P. 114

- ▶ Vehicles with the multi-information display type B

The trip meter data will be reset.

If the trip meter was displayed last, the ODO screen will be displayed after resetting.



NOTICE

■ **To prevent damage to the engine and its components**

- Do not let the indicator needle of the tachometer enter the red zone, which indicates the maximum engine speed.
- The engine may be overheating if the engine coolant temperature gauge is in the red zone (H). In this case, immediately stop the vehicle in a safe place, and check the engine after it has cooled completely. (→P. 669)

Multi-information display (Type A)*

Display contents

The multi-information display presents the driver with a variety of driving-related data including the current outside air temperature.

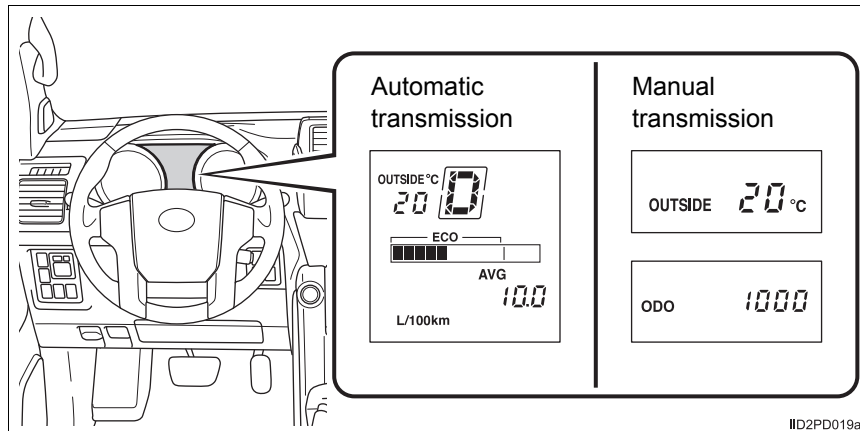

2

Instrument cluster

- Outside temperature display (→P. 112)
- Trip information contents (→P. 111)
- Shift position and shift range (if equipped) (→P. 251)
- Eco Driving Indicator Zone Display (if equipped) (→P. 113)

*: If equipped

Switching the display

Items displayed can be switched by pressing the “ODO/TRIP” button.

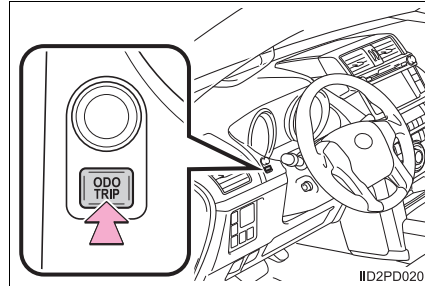

Trip information contents

■ Odometer

Displays the total distance the vehicle has been driven.

■ Trip meters A and B

Displays the distance the vehicle has been driven since the meter was last reset. Trip meters A and B can be used to record and display different distances independently.

Press the hold the button to reset.

■ Driving range

Displays the estimated maximum distance that can be driven with the quantity of fuel remaining

- This distance is computed based on your average fuel consumption. As a result, the actual distance that can be driven may differ from that displayed.
- When only a small amount of fuel is added to the tank, the display may not be updated.

When refueling, turn the engine switch off. If the vehicle is refueled without turning the engine switch off, the display may not be updated.

■ Current fuel consumption

Displays the current rate of fuel consumption

■ Eco Driving Indicator Zone Display*

→P. 113

■ Average fuel consumption

Displays the average fuel consumption since the function was reset

- The function can be reset by pressing the “ODO/TRIP” button for longer than 1 second when the average fuel consumption is displayed.
- Use the displayed average fuel consumption as a reference.

- **Average vehicle speed**

Displays the average vehicle speed since the engine was started or the function was reset

The function can be reset by pressing the “ODO/TRIP” button for longer than 1 second when the average vehicle speed is displayed.

- **Outside temperature display**

Displays the outside temperature

The temperature range that can be displayed is from -40°C (-40°F) to 50°C (122°F).

- **Eco Driving Indicator Light setting screen***

Eco Driving Indicator Light can be set to on or off.

The function can be activated or deactivated by pressing the “ODO/TRIP” button for longer than 1 second when Eco Driving Indicator Light setting screen is displayed.

*: Displayed on vehicles with an automatic transmission only

■ **Eco Driving Indicator (vehicles with an automatic transmission)**

- ① Eco Driving Indicator Light
During Eco-friendly acceleration (Eco driving), Eco Driving Indicator Light will turn on.
- ② Eco Driving Indicator Zone Display
Suggests Zone of Eco driving with current Eco driving ratio based on acceleration.
- ③ Zone of Eco driving
- ④ Eco driving ratio based on acceleration
If the vehicle exceeds Zone of Eco driving, the right side of Eco Driving Indicator Zone Display will blink and Eco Driving Indicator Light will turn off.

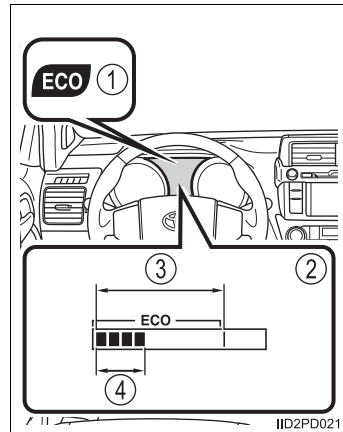

Eco Driving Indicator Light will not operate in the following conditions:

- The shift lever is in anything other than D.
- The vehicle is set to second start mode. (→P. 254)
- The vehicle speed is approximately 130 km/h (80 mph) or higher.

■ When disconnecting and reconnecting battery terminals

The following information data will be reset:

- Trip meter
- Average fuel consumption
- Average vehicle speed

If the trip meter was displayed last, the ODO screen will be displayed after resetting.

■ Customization

Settings (e.g. available language) can be changed.
(Customizable features →P. 706)

 **CAUTION****■ The multi-information display at low temperatures (vehicles with an automatic transmission)**

Allow the interior of the vehicle to warm up before using the multi-information display. At extremely low temperatures, the multi-information display monitor may respond slowly, and display changes may be delayed.

For example, there is a lag between the driver's shifting and the new gear number appearing on the display. This lag could cause the driver to down-shift again, causing rapid and excessive engine braking and possibly an accident resulting in death or serious injury.

 **NOTICE****■ The multi-information display at low temperatures**

Allow the interior of the vehicle to warm up before using the multi-information display. At extremely low temperatures, the multi-information display monitor may respond slowly, and display changes may be delayed.

Multi-information display (Type B)*

Display contents

The multi-information display presents the driver with a variety of driving-related data including the current outside air temperature.

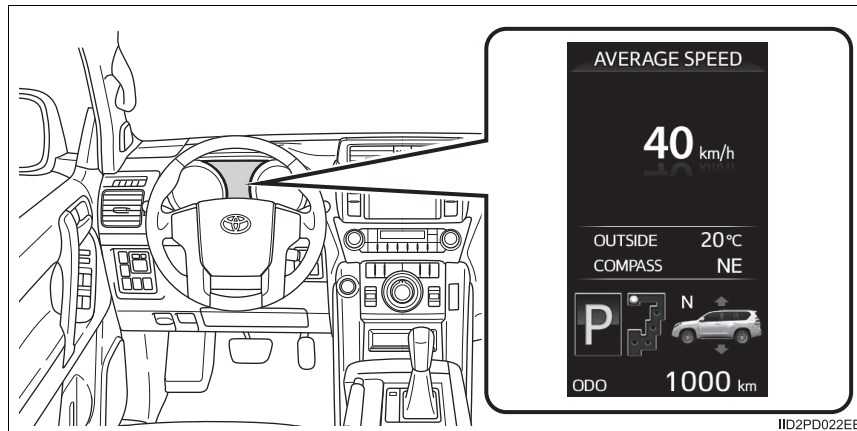

- Trip information contents (→P. 116)
Displays driving range, fuel consumption and other cruising related information
- Electronic features control contents (→P. 117)
- Other contents (→P. 118)

*: If equipped

Switching the display

① Menu switch

Changes modes to electronic features control mode, customization mode or back to normal display mode

② “ENTER” switch

Changes trip information items. This switch is also used to turn on/off electronic features controls and to change customization settings.

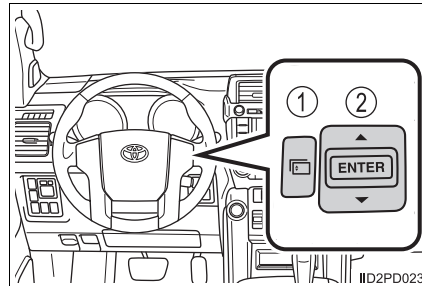

Trip information contents

Trip information items displayed can be switched by pressing the “ENTER” switch upwards or downwards.

■ **Front tire angle**

The direction of the front tires is displayed

The tire direction is displayed in 3 stages for both left and right, in accordance with the angle of the tire.

■ **Speedometer**

Displays the vehicle speed.

■ **Driving range**

Displays the estimated maximum distance that can be driven with the quantity of fuel remaining

- This distance is computed based on your average fuel consumption. As a result, the actual distance that can be driven may differ from that displayed.
- When only a small amount of fuel is added to the tank, the display may not be updated.

■ **Average fuel consumption after refueling**

Displays the average fuel consumption since the vehicle was last refueled

Use the displayed average fuel consumption as a reference.

■ **Current fuel consumption**

Displays the current rate of fuel consumption

■ **Average fuel consumption**

Displays the average fuel consumption since the function was reset

- The function can be reset by pressing the “ENTER” switch for longer than 1 second when the average fuel consumption is displayed.
- Use the displayed average fuel consumption as a reference.

■ **Eco Driving Indicator Zone Display**

→P. 120

■ **Average vehicle speed**

Displays the average vehicle speed since the engine was started or the function was reset

The function can be reset by pressing the “ENTER” switch for longer than 1 second when the average vehicle speed is displayed.

■ **Elapsed time**

Displays the elapsed time since the function was last reset

The function can be reset by pressing the “ENTER” switch for longer than 1 second when the elapsed time is displayed.

■ **Clinometer (L4L/L4 only)**

→Refer to the “Off-road Driving Owner’s Manual”

■ **Differential lock/unlock display (L4L/L4 only)**

→Refer to the “Off-road Driving Owner’s Manual”

■ **Active TRC (Traction Control) display (L4L/L4 only)**

→Refer to the “Off-road Driving Owner’s Manual”

■ **Display off**

A blank screen is displayed

Electronic features control contents

■ **Toyota parking assist-sensor (if equipped) (→P. 312)**

■ **BSM (Blind Spot Monitor) (if equipped) (→P. 366)**

■ **Second start mode (if equipped) (→P. 254)**

Other contents

- **Shift position and shift range (if equipped) (→P. 251)**
- **Rear height control air suspension display (if equipped)**
→Refer to the “Off-road Driving Owner’s Manual”
- **Multi-terrain Select display (if equipped)**
→Refer to the “Off-road Driving Owner’s Manual”
- **Crawl Control display* (if equipped)**
→Refer to the “Off-road Driving Owner’s Manual”
- **Dynamic radar cruise control display* (if equipped) (→P. 296)**
- **Warning messages (→P. 606)**
Automatically displayed when a malfunction occurs in one of the vehicles systems
- **Compass (vehicles with a navigation system)**
The compass indicates the direction in which the vehicle is heading.
Displays and directions: →P. 121
- **Outside temperature display**
Displays the outside temperature
The temperature range that can be displayed is from -40°C (-40°F) to 50°C (122°F).
When the outside temperature drops below 3 °C,  and the outside temperature are displayed.
- **Turn-by-turn navigation screen (vehicles with a navigation system) (→P. 119)**
If the turn-by-turn navigation setting screen is not displayed, set the destination. When the destination is set, the turn-by-turn navigation screen is displayed.
- **Customization**
Settings (e.g. available language) can be changed.
(Customizable features →P. 706)

*: Automatically displayed when the system is used

■ **Electronic features control can be turned on/off when**

- ▶ Vehicles without a smart entry & start system
The engine switch is in the “ON” position.
- ▶ Vehicles with a smart entry & start system
The engine switch is in IGNITION ON mode.

■ **System check display**

- ▶ Vehicles with a smart entry & start system
After switching the engine switch to IGNITION ON mode, opening image is displayed while system operation is checked. When the system check is complete, the normal screen will return.
- ▶ Vehicles without a smart entry & start system
After turning the engine switch to “ON” position, opening image is displayed while system operation is checked. When the system check is complete, the normal screen will return.

■ **Conditions for ending electronic features control**

In the following situations, the electronic features control will end automatically:

- The menu switch is pressed
- Toyota parking assist-sensor starts operating (if equipped)
- The Crawl Control is operated (if equipped)
- The dynamic radar cruise control is operated (if equipped)
- A warning message appears after the electronic features control screen is displayed

■ **Turn-by-turn navigation (vehicles with a navigation system)**

The turn-by-turn navigation appears only while route guidance of the navigation system is being performed. When a turn approaches, the distance to the turn and the turn direction are displayed.

- ① Distance to the next turn
- ② Turn direction

The image shown may differ from the actual intersection.

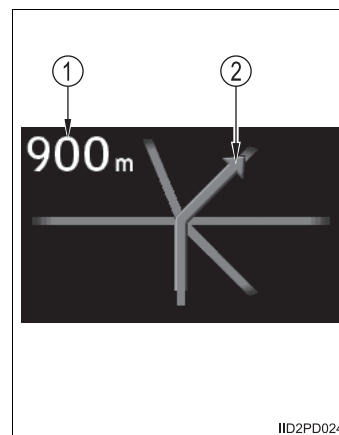

■ Eco Driving Indicator (vehicles with an automatic transmission)

- ① Eco Driving Indicator Light
During Eco-friendly acceleration (Eco driving), Eco Driving Indicator Light will turn on.
- ② Eco Driving Indicator Zone Display
Suggests Zone of Eco driving with current Eco driving ratio based on acceleration.
- ③ Zone of Eco driving
- ④ Eco driving ratio based on acceleration
If the vehicle exceeds Zone of Eco driving, the right side of Eco Driving Indicator Zone Display will blink and Eco Driving Indicator Light will turn off.

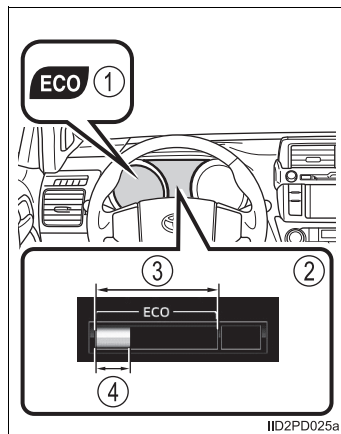

Eco Driving Indicator Light will not operate in the following conditions:

- The shift lever is in anything other than D.
- The vehicle is set to second start mode. (→P. 254)
- The vehicle speed is approximately 130 km/h (80 mph) or higher.

■ Displays and directions of the compass

Display	Direction
N	North
NE	Northeast
E	East
SE	Southeast
S	South
SW	Southwest
W	West
NW	Northwest

■ Outside temperature display

In the following situations, the correct outside temperature may not be displayed, or the display may take longer than normal to change:

- When the vehicle is stopped, or moving at low speeds (less than 20 km/h [12 mph])
- When the outside temperature has changed suddenly (at the entrance/exit of a garage, tunnel, etc.)

■ When “--” or “E” is displayed

The system may be malfunctioning. Take your vehicle to any authorized Toyota dealer or repairer, or another duly qualified and equipped professional.

■ When disconnecting and reconnecting battery terminals

- The following information data will be reset:
 - Average fuel consumption after refueling
 - Average fuel consumption
 - Average vehicle speed
 - Elapsed time
- The following information data will be initialized:
 - Turn-by-turn navigation (vehicles with a navigation system)

 CAUTION**■ The multi-information display at low temperatures (vehicles with an automatic transmission)**

Allow the interior of the vehicle to warm up before using the multi-information display. At extremely low temperatures, the multi-information display monitor may respond slowly, and display changes may be delayed.

For example, there is a lag between the driver's shifting and the new gear number appearing on the display. This lag could cause the driver to down-shift again, causing rapid and excessive engine braking and possibly an accident resulting in death or serious injury.

 NOTICE**■ The multi-information display at low temperatures**

Allow the interior of the vehicle to warm up before using the multi-information display. At extremely low temperatures, the multi-information display monitor may respond slowly, and display changes may be delayed.

Fuel consumption information*

The fuel consumption information can be displayed on the navigation system or multimedia system screen.

Display the screen

Press the “CAR” button, and then select “Trip information” on the screen.

Fuel consumption

- ① Cruising range
- ② Previous fuel consumption per minute
- ③ Reset the trip information data

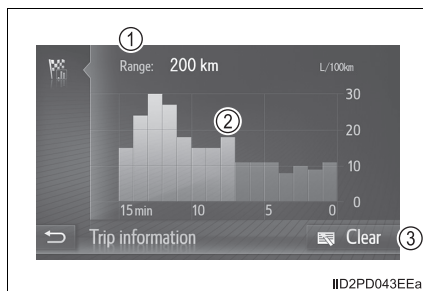

Average fuel consumption for the past 15 minutes is divided by color into past averages and averages attained since the engine switch was last turned to the “ON” position (vehicles without a smart entry & start system) or IGNITION ON mode (vehicles with a smart entry & start system). Use the displayed average fuel consumption as a reference.

These images are examples only, and may vary slightly from actual conditions.

■ Resetting the data

Selecting “Clear” on the consumption screen will reset the consumption data.

■ Cruising range

Displays the estimated maximum distance that can be driven with the quantity of fuel remaining.

This distance is computed based on your average fuel consumption. As a result, the actual distance that can be driven may differ from that displayed.

*: If equipped

**Operation of
each component****3**

3-1. Key information	
Keys.....	124
3-2. Opening, closing and locking the doors	
Side doors.....	130
Back door.....	140
Glass hatch.....	147
Smart entry & start system	153
3-3. Adjusting the seats	
Front seats.....	170
Rear seats	173
Driving position memory	188
Head restraints	192
3-4. Adjusting the steering wheel and mirrors	
Steering wheel	195
Inside rear view mirror	198
Outside rear view mirrors	200
3-5. Opening and closing the windows and moon roof	
Power windows.....	203
Moon roof.....	206

Keys

The keys

The following keys are provided with the vehicle.

- ▶ Vehicles without a smart entry & start system (type A)

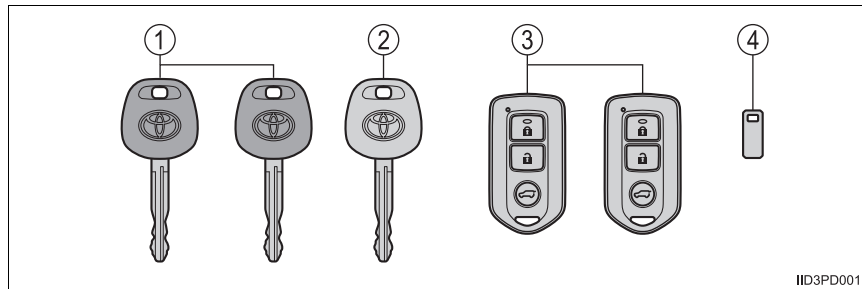

- ① Master keys
- ② Valet key
- ③ Wireless remote controls
Operating the wireless remote control function
- ④ Key number plate

▶ Vehicles without a smart entry & start system (type B)

- ① Master keys
 - Operating the wireless remote control function
- ② Valet key
- ③ Key number plate

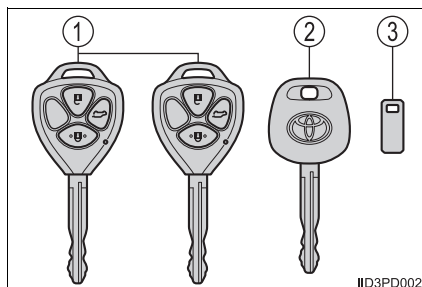

▶ Vehicles with a smart entry & start system

- ① Electronic keys
 - Operating the smart entry & start system (→P. 153)
 - Operating the wireless remote control function
- ② Mechanical keys
- ③ Key number plate

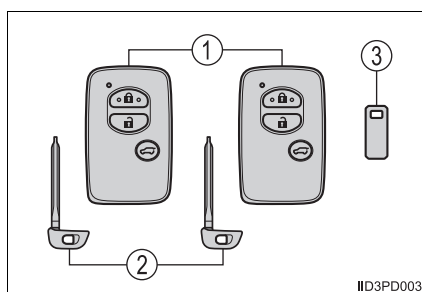

3

Index

Wireless remote control

▶ Vehicles without a smart entry & start system (type A)

- ① Locks the doors (→P. 130)
- ② Closes the windows and moon roof* (→P. 130)
- ③ Unlocks the doors (→P. 130)
- ④ Opens the windows and moon roof* (→P. 130)
- ⑤ Opens the glass hatch (→P. 147)

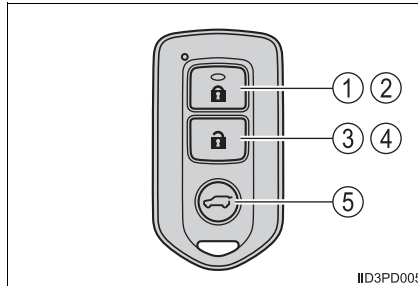

*: These settings must be customized at any authorized Toyota dealer or repairer, or another duly qualified and equipped professional.

▶ Vehicles without a smart entry & start system (type B: 2 switches)

- ① Locks the doors (→P. 130)
- ② Closes the windows and moon roof* (→P. 130)
- ③ Unlocks the doors (→P. 130)
- ④ Opens the windows and moon roof* (→P. 130)

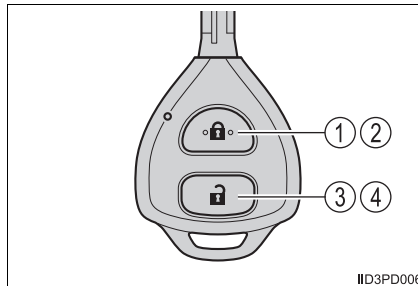

*: These settings must be customized at any authorized Toyota dealer or repairer, or another duly qualified and equipped professional.

► Vehicles without a smart entry & start system (type B: 3 switches)

- ① Locks the doors (→P. 130)
- ② Closes the windows and moon roof* (→P. 130)
- ③ Unlocks the doors (→P. 130)
- ④ Opens the windows and moon roof* (→P. 130)
- ⑤ Opens the glass hatch (→P. 147)

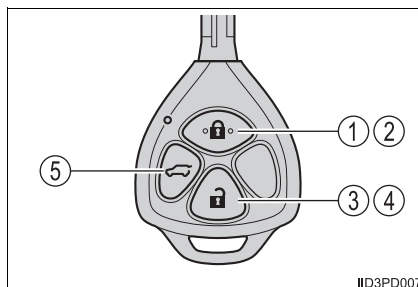

*: These settings must be customized at any authorized Toyota dealer or repairer, or another duly qualified and equipped professional.

► Vehicles with a smart entry & start system

- ① Locks the doors (→P. 130)
- ② Closes the windows and moon roof* (→P. 130)
- ③ Unlocks the doors (→P. 130)
- ④ Opens the windows and moon roof* (→P. 130)
- ⑤ Opens the glass hatch (vehicles with a glass hatch) (→P. 147)

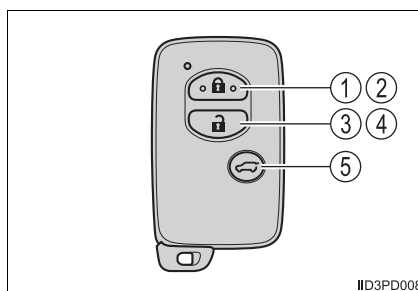

*: These settings must be customized at any authorized Toyota dealer or repairer, or another duly qualified and equipped professional.

Using the mechanical key (vehicles with a smart entry & start system)

To take out the mechanical key, push the release button and take the key out.

After using the mechanical key, store it in the electronic key. Carry the mechanical key together with the electronic key. If the electronic key battery is depleted or the entry function does not operate properly, you will need the mechanical key. (→P. 660)

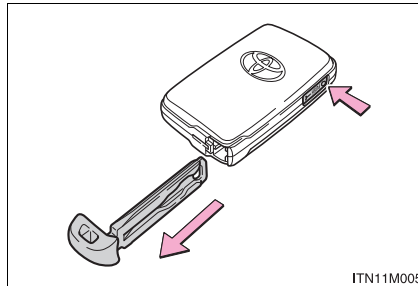
**■ When required to leave the vehicle's key with a parking attendant**

Lock the glove box as circumstances demand. (→P. 481)

▶ Vehicles without a smart entry & start system

Carry the master key for your own use and provide the attendant with the valet key.

▶ Vehicles with a smart entry & start system

Remove the mechanical key for your own use and provide the attendant with the electronic key only.

■ If you lose your keys/wireless remote control

▶ Keys

New genuine keys can be made by any authorized Toyota dealer or repairer, or another duly qualified and equipped professional using a master key (vehicles without a smart entry & start system) or the other key (vehicles with a smart entry & start system) and the key number stamped on your key number plate. Keep the plate in a safe place such as your wallet, not in the vehicle.

▶ Wireless remote control (if equipped)

New genuine wireless remote control can be purchased and programmed by any authorized Toyota dealer or repairer, or another duly qualified and equipped professional. If a wireless remote control has been lost, bring the other wireless remote control when going to pick up the new one.

■ When riding in an aircraft

When bringing a key with wireless remote control function onto an aircraft, make sure you do not press any buttons on the key while inside the aircraft cabin. If you are carrying the key in your bag etc., ensure that the buttons are not likely to be pressed accidentally. Pressing a button may cause the key to emit radio waves that could interfere with the operation of the aircraft.

■ Key battery depletion

- ▶ Vehicles without a smart entry & start system

If the wireless remote control function does not operate, the battery may be depleted. Replace the battery when necessary. (→P. 559)

- ▶ Vehicles with a smart entry & start system

→P. 159

■ Replacing the electronic key battery

→P. 559

 NOTICE**■ To prevent key damage**

- Do not drop the keys, subject them to strong shocks or bend them.
- Do not expose the keys to high temperatures for long periods of time.
- Do not get the keys wet or wash them in an ultrasonic washer etc.
- Do not attach metallic or magnetic materials to the keys or place the keys close to such materials.
- Do not disassemble the keys.
- Do not attach a sticker or anything else to the surface of the electronic key.
- Do not place the keys near objects that produce magnetic fields, such as TVs, audio systems and induction cookers, or medical electrical equipment, such as low-frequency therapy equipment.

■ Carrying the electronic key on your person (vehicles with a smart entry & start system)

Carry the electronic key 10 cm (3.9 in.) or more away from electric appliances that are turned on. Radio waves emitted from electric appliances within 10 cm (3.9 in.) of the electronic key may interfere with the key, causing the key to not function properly.

■ In case of a smart entry & start system malfunction or other key-related problems (vehicles with a smart entry & start system)

Take your vehicle with all the electronic keys provided with your vehicle to any authorized Toyota dealer or repairer, or another duly qualified and equipped professional.

■ When an electronic key is lost (vehicles with a smart entry & start system)

If the electronic key remains lost, the risk of vehicle theft increases significantly. Visit any authorized Toyota dealer or repairer, or another duly qualified and equipped professional immediately with all remaining electronic keys that were provided with your vehicle.

Side doors

The vehicle can be locked and unlocked using the entry function, wireless remote control, key or door lock switch.

Locking and unlocking the doors from the outside

◆ Smart entry & start system (if equipped)

Carry the electronic key to enable this function.

- ① Grip the front door handle to unlock the doors.

Make sure to touch the sensor on the back of the handle.

The doors cannot be unlocked for 3 seconds after the doors are locked.

- ② Touch the lock sensor (the indentation on the upper or lower part of the front door handle) to lock the doors.

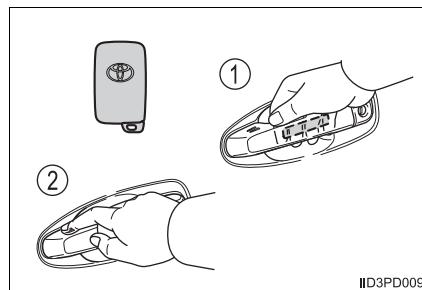

◆ Wireless remote control

- ▶ Vehicles without a smart entry & start system (type A)

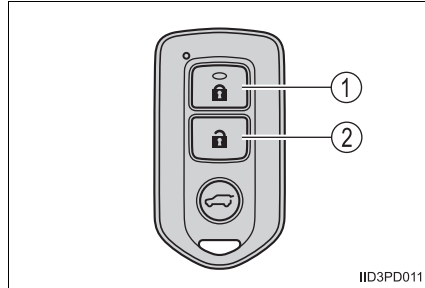

- ▶ Vehicles without a smart entry & start system (type B: 2 switches)

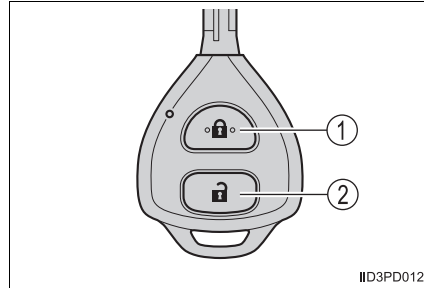

- ▶ Vehicles without a smart entry & start system (type B: 3 switches)

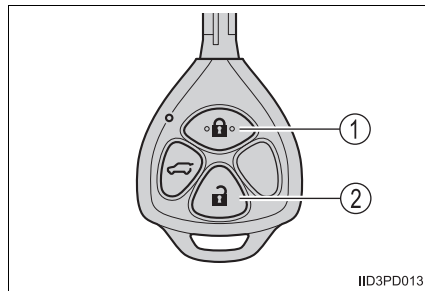

- ▶ Vehicles with a smart entry & start system

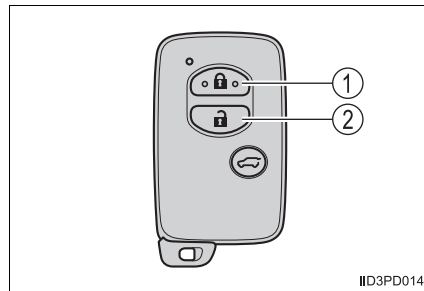

- ① Locks all the doors
Press and hold to close the windows and moon roof.*
- ② Unlocks all the doors
Press and hold to open the windows and moon roof.*

*: These settings must be customized at any authorized Toyota dealer or repairer, or another duly qualified and equipped professional.

◆ **Key**

▶ Vehicles without a smart entry & start system

- ① Locks all the doors
Turn and hold to close the windows and moon roof.*
- ② Unlocks all the doors
Turn and hold to open the windows and moon roof.*

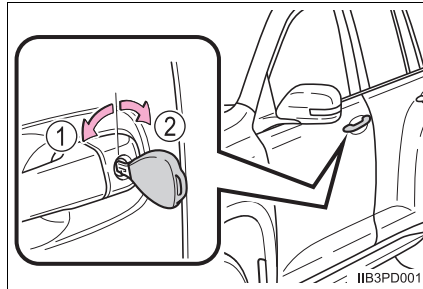

*: These settings must be customized at any authorized Toyota dealer or repairer, or another duly qualified and equipped professional.

▶ Vehicles with a smart entry & start system

The doors can also be locked and unlocked with the mechanical key. (→P. 660)

■ **Operation signals**

Doors: A buzzer (if equipped) sounds and the emergency flashers flash to indicate that the doors have been locked/unlocked. (Locked: Once; Unlocked: Twice)

Windows and moon roof: A buzzer sounds to indicate that the windows and moon roof are operating.

■ **Security feature**

If a door is not opened within approximately 30 seconds after the vehicle is unlocked, the security feature automatically locks the vehicle again.

■ **When the door cannot be locked by the lock sensor on the upper part of the door handle (vehicles with a smart entry & start system)**

If the door will not lock even when the top-side sensor area is touched, try touching both the topside and underside sensor areas at the same time.

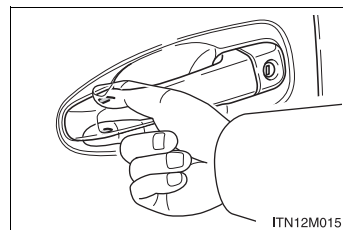

■ Door lock buzzer

If an attempt to lock the doors is made when a door is not fully closed, a buzzer sounds continuously for 5 seconds. Fully close the door to stop the buzzer, and lock the vehicle once more.

■ Setting the alarm (if equipped)

Locking the doors will set the alarm system. (→P. 92)

■ If the smart entry & start system or the wireless remote control does not operate properly (vehicles with a smart entry & start system)

- Use the mechanical key to lock and unlock the doors. (→P. 660)
- Replace the battery with a new one if it is depleted. (→P. 559)

⚠ CAUTION**■ When closing the windows or moon roof using wireless remote control**

Observe the following precautions. Failing to do so may result in death or serious injury.

- Check to make sure that all passengers do not have any part of their body in a position where it could be caught when a window or moon roof is being operated.
- To prevent inadvertent power windows and moon roof operation, never let a small child have and use the wireless remote control.

■ Jam protection function

- Never try jamming any part of your body to activate the jam protection function intentionally.
- The jam protection function may not work if something gets caught just before the window or moon roof fully closes.

Locking and unlocking the doors from the inside

◆ Door lock switch

- ① Locks all the doors
- ② Unlocks all the doors

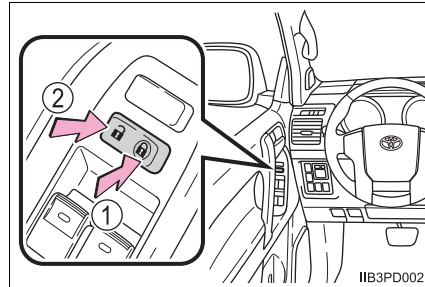

◆ Inside lock button

- ① Locks the door
- ② Unlocks the door

The driver's door and front passenger's door (for some models only) can be opened by pulling the inside handle even if the lock button is in the lock position.

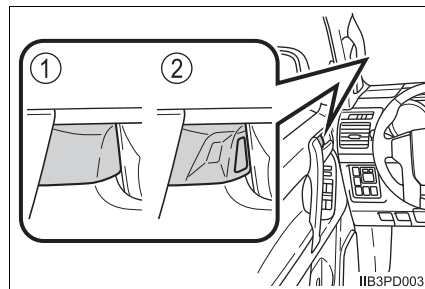

Locking the front doors from the outside without a key

- 1 Move the inside lock button to the lock position.
- 2 Close the door while pulling the door handle.

► Vehicles without a smart entry & start system

The door cannot be locked if the key is in the engine switch.

► Vehicles with a smart entry & start system

The door cannot be locked if the engine switch is in ACCESSORY or IGNITION ON mode, or the electronic key is left inside the vehicle. However, the key may not be detected correctly and the door may be locked.

Rear door child-protector lock (5-door models)

The door cannot be opened from inside the vehicle when the lock is set.

- 1 Unlock
- 2 Lock

These locks can be set to prevent children from opening the rear doors. Push down on each rear door switch to lock both rear doors.

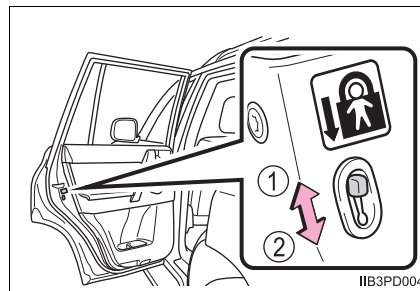

Automatic door locking and unlocking systems (if equipped)



The following functions can be set or canceled:

Function	Operation
Shift position linked door locking function*	Shifting the shift lever out of P locks all the doors.
Shift position linked door unlocking function*	Shifting the shift lever to P unlocks all the doors.
Speed linked door locking function	All the doors are locked when the vehicle speed is approximately 20 km/h (12 mph) or higher.
Driver's door linked door unlocking function	All the doors are unlocked when the driver's door is opened within 43 seconds after turning the engine switch off.

*: Vehicles with an automatic transmission

■ Setting and canceling the functions





To switch between setting and canceling, follow the procedure below.

- 1 Close all the doors and turn the engine switch to IGNITION ON mode. (Perform step 2 within 20 seconds.)
- 2 Shift the shift lever to P or N, and press and hold the driver's door lock switch ( or ) for approximately 5 seconds and then release.

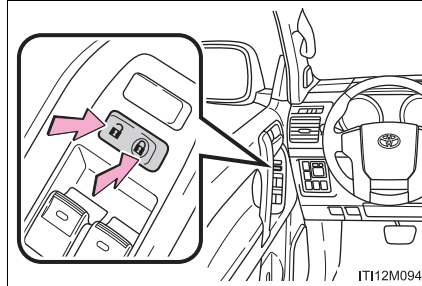
The shift lever and switch positions corresponding to the desired function to be set are shown in the following table.

Use the same procedure to cancel the function.





Function	Shift lever position	Driver's door lock switch position
Shift position linked door locking function*	P	
Shift position linked door unlocking function*		
Speed linked door locking function	N	
Driver's door linked door unlocking function		

*: Vehicles with an automatic transmission

When the setting or canceling operation is complete, all the doors are locked and then unlocked.

■ **Changing the door unlock function setting (vehicles with a smart entry & start system)**

It is possible to set which doors the entry function unlocks using the wireless remote control.

- 1 Turn the engine switch off.
- 2 Cancel the intrusion sensor and tilt sensor of the alarm system to prevent unintended triggering of the alarm during the setting change. (→P. 95)
- 3 When the indicator on the key surface is turned off, press and hold  or  (if equipped) for approximately 5 seconds while pressing  on the key.

The setting changes each time an operation is performed, as shown below. (When changing the setting continuously, release the buttons, wait for at least 5 seconds, and repeat step 3.)

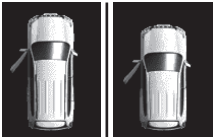
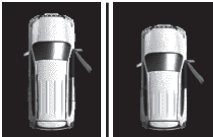
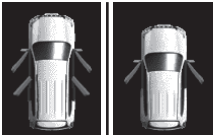
Multi-information display	Unlocking function	Beep
 (Left-hand drive vehicles)	Holding the driver's door handle unlocks only the driver's door.	Exterior: Beeps 3 times Interior: Pings once
 (Right-hand drive vehicles)	Holding the front passenger's door handle unlocks all the doors.	
	Holding either door handle unlocks all the doors.	Exterior: Beeps twice Interior: Pings once

For vehicles with an alarm: To prevent unintended triggering of the alarm, unlock the doors using the wireless remote control and open and close a door once after the settings have been changed. (If a door is not opened within 30 seconds after  is pressed, the doors will be locked again and the alarm will automatically be set.)

In case that the alarm is triggered, immediately stop the alarm. (→P. 92)

■ Impact detection door lock release system (if equipped)

In the event that the vehicle is subject to a strong impact, all the doors are unlocked. Depending on the force of the impact or the type of accident, however, the system may not operate.

■ Conditions affecting the operation of the smart entry and start system or wireless remote control

▶ Vehicles without a smart entry & start system

The wireless remote control function may not operate normally in the following situations.

- Near a TV tower, radio station, electric power plant, airport or other facility that generates strong radio waves
- When carrying a portable radio, cellular phone or other wireless communication device
- When multiple wireless keys are in the vicinity
- When the wireless key has come into contact with, or is covered by a metallic object
- When a wireless key (that emits radio waves) is being used nearby
- When the wireless key has been left near an electrical appliance such as a personal computer

▶ Vehicles with a smart entry & start system

→P. 157

■ Customization

Settings (e.g. unlocking function using a key) can be changed.
(Customizable features →P. 705)

CAUTION

■ To prevent an accident

Observe the following precautions while driving the vehicle. Failing to do so may result in a door opening and an occupant falling out, resulting in death or serious injury.

- Ensure that all the doors are properly closed.
- Do not pull the inside handle of the doors while driving.
Be especially careful for the front doors, as the doors may be opened even if the inside lock button is in locked position.
- Set the rear door child-protector locks when children are seated in the second seat.

Back door

The back door can be locked/unlocked and opened by the following procedures.

Locking and unlocking the back door from the outside

◆ Smart entry & start system (if equipped)

Carry the electronic key to enable this function.

▶ Vehicles with back door mounted spare tire

- ① Locks all the doors
- ② Unlocks all the doors

The doors cannot be unlocked for 3 seconds after the doors are locked.

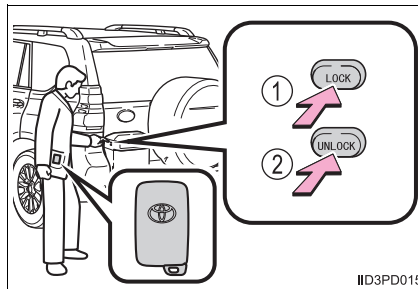

▶ Vehicles with under floor mounted spare tire

- ① Locks all the doors
- ② Unlocks all the doors

The doors cannot be unlocked for 3 seconds after the doors are locked.

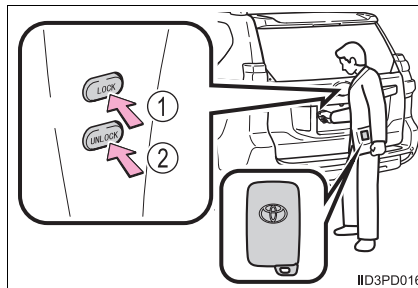

◆ Wireless remote control

→P. 132

Locking and unlocking the back door from the inside**◆ Door lock switch**

- ① Locks all the doors
- ② Unlocks all the doors

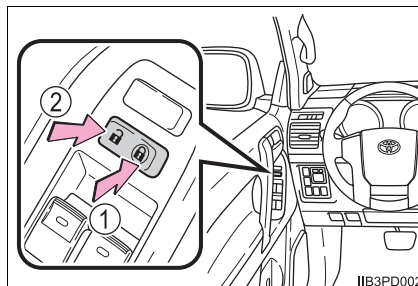
**◆ Inside lock button (vehicles with longitudinal type third seats)**

- ① Locks the door
- ② Unlocks the door

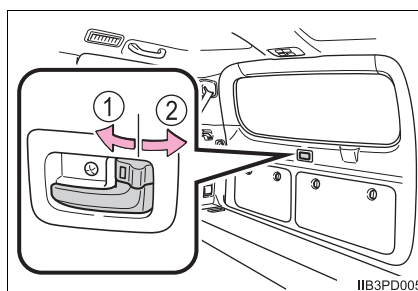

Opening the back door from the outside

► Vehicles with back door mounted spare tire

- ① Pull the handle
- ② Open the back door

The back door can be kept open at a desired position.

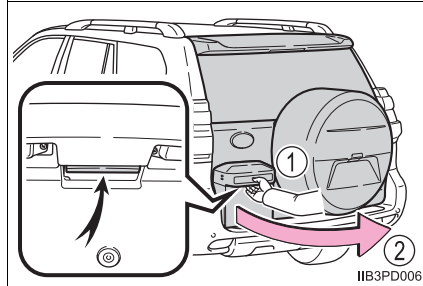

► Vehicles with under floor mounted spare tire

- ① Pull the handle
- ② Open the back door

The back door can be kept open at a desired position.

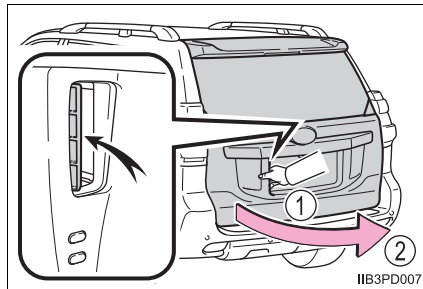

Keeping the back door open

- ① Unlocks the back door stopper
- ② Locks the back door stopper

The back door stopper can only be operated when the back door is fully open.

When closing the back door, check that the back door stopper is unlocked.

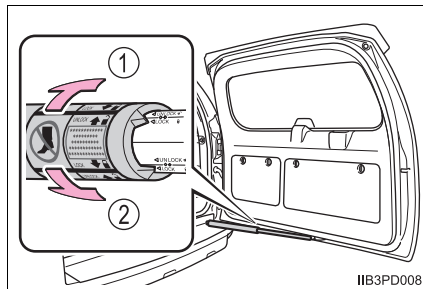

Back door child-protector lock (vehicles with longitudinal type third seats)

The door cannot be opened from inside the vehicle when the lock is set.

- ① Unlock
- ② Lock

This lock can be set to prevent children from opening the back door. Push down on back door switch to lock back door.

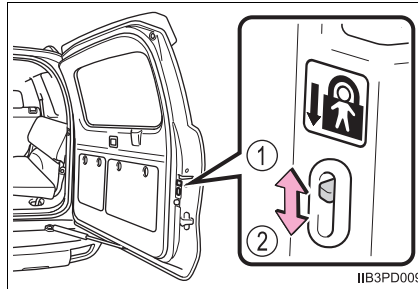
**When closing the back door**

Close the back door using the back door handle, and make sure to push the back door from the outside to close it.

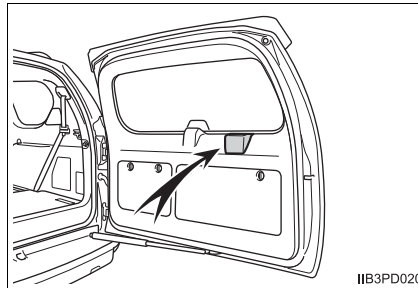
**Rear step bumper**

The rear step bumper is for rear end protection and easier step-up loading.

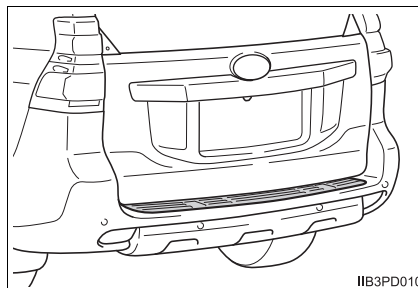

 CAUTION

■ **While driving**

- Keep the back door closed while driving.
If the back door is left open, it may hit near-by objects while driving or luggage may be unexpectedly thrown out, causing an accident.
In addition, exhaust gases may enter the vehicle, causing death or a serious health hazard. Make sure to close the back door before driving.
- Before driving the vehicle, make sure that the back door is fully closed. If the back door is not fully closed, it may open unexpectedly while driving, causing an accident.
- Never let anyone sit in the luggage compartment. In the event of sudden braking, sudden swerving or a collision, they are susceptible to death or serious injury.

■ **When children are in the vehicle**

Observe the following precautions.

Failure to do so may result in death or serious injury.

- Do not allow children to play in the luggage compartment.
If a child is accidentally locked in the luggage compartment, they could have heat exhaustion or other injuries.
- Do not allow a child to open or close the back door.
Doing so may cause the back door to move unexpectedly, or cause the child's hands, head, or neck to be caught by the closing back door.

■ **Operating the back door**

Observe the following precautions.

Failure to do so may cause parts of the body to be caught, resulting in death or serious injury.

- When opening or closing the back door, thoroughly check to make sure the surrounding area is safe.
- If anyone is in the vicinity, make sure they are safe and let them know that the back door is about to open or close.
- Use caution when opening or closing the back door in windy weather as it may move abruptly in strong wind.

⚠ CAUTION**■ Operating the back door**

- The back door may close if the back door stopper is not locked (specifically, when using the luggage compartment with the back door kept open at your desired position). It is more difficult to open or close the back door on an incline than on a level surface, so beware of the back door unexpectedly opening or closing by itself. Make sure that the back door stopper is locked and secure before using the luggage compartment.

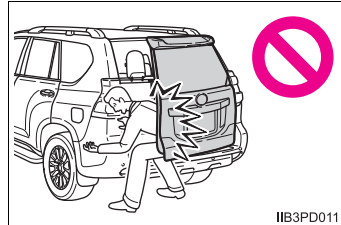

- When closing the back door, take extra care to prevent your fingers etc. from being caught.

- When closing the back door, make sure to press it lightly on its outer surface. If the back door handle is used to fully close the back door, it may result in hands or arms being caught.

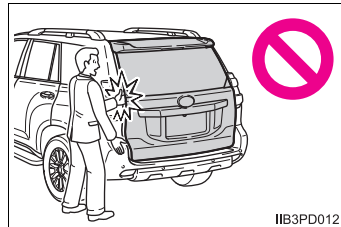

- Do not pull on the back door damper stay to close the back door, and do not hang on the back door damper stay. Doing so may cause hands to be caught or the back door damper stay to break, causing an accident.

- If a bicycle carrier or similar heavy object is attached to the back door, it may suddenly shut again after being opened, causing someone's hands, head or neck to be caught and injured. When installing an accessory part to the back door, using a genuine Toyota part is recommended.

 NOTICE

■ **Back door damper stay**

The back door is equipped with damper stay that hold the back door in place.

Observe the following precautions.

Failure to do so may cause damage to the back door damper stay, resulting in malfunction.

- Do not attach any accessories other than genuine Toyota parts to the back door.
- Do not lean against, climb on or place luggage on the damper stay, or apply lateral forces to it.

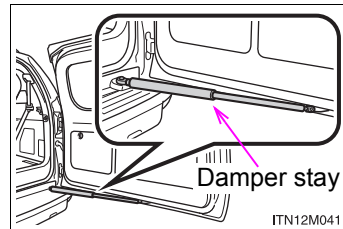

Glass hatch*

The glass hatch can be opened using the glass hatch opener or wireless remote control.

Opening the glass hatch

◆ Glass hatch opener

- ① Press the button to pop up the glass hatch.
- ② Raise
The glass hatch cannot be opened when the back door is locked. Unlock the back door to open the glass hatch.
(→P. 141)

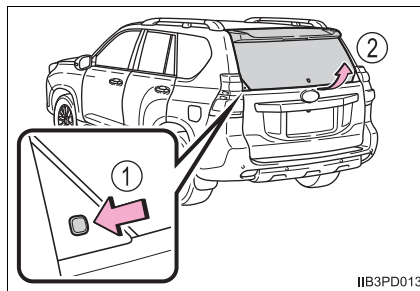

IIB3PD013

◆ Smart entry & start system (if equipped)

- ① While carrying the electronic key, press the button to pop up the glass hatch.
- ② Raise
The glass hatch can be opened even when the back door is locked.

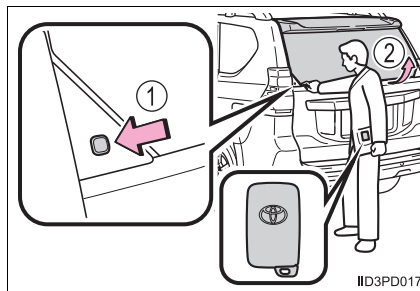

IID3PD017

*: If equipped

◆ **Wireless remote control**

Press and hold the button to open the glass hatch. The glass hatch will pop up.

- ▶ Vehicles without a smart entry & start system (type A)
- ▶ Vehicles without a smart entry & start system (type B)

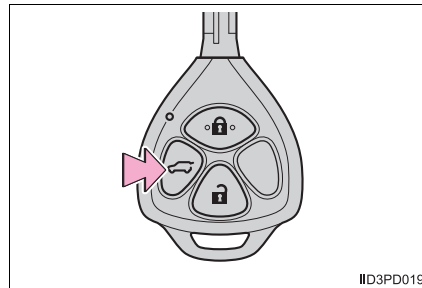
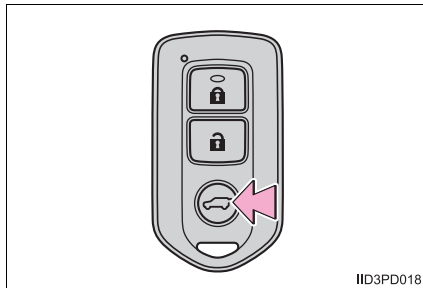

- ▶ Vehicles with a smart entry & start system

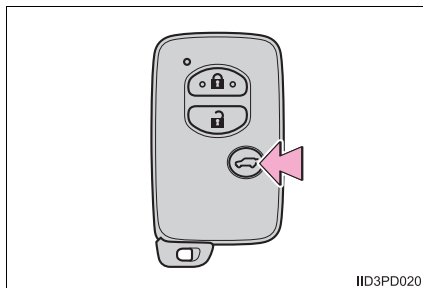

■ When opening the glass hatch

- Open the glass hatch slowly and carefully.
- Use the glass hatch opener or wireless remote control when the back door is closed.

■ Operation signals (when opening with the wireless remote control)

A buzzer (if equipped) sounds once to indicate that the glass hatch have been opened.

■ Opening the glass hatch while the rear window wiper is in operation

Rear window wiper operation will stop moving. Operation will recommence after the glass hatch has been closed.

■ Function to prevent the glass hatch being locked with the electronic key inside (vehicles with a smart entry & start system)

- When all doors are being locked, closing the glass hatch with the electronic key left inside the luggage compartment will sound an alarm. In this case, the glass hatch can be opened using the entry function.
- Even when the spare electronic key is put in the luggage compartment with all the doors locked, the key confinement prevention function can be activated so the glass hatch can be opened. In order to prevent theft, take all electronic keys with you when leaving the vehicle.
- Even when the electronic key is put in the luggage compartment with all the doors are locked, the key may not be detected depending on the places and the surrounding radio wave conditions. In this case, the key confinement prevention function cannot be activated, causing the doors to lock when the glass hatch is closed. Make sure to check where the key is before closing the glass hatch.

■ After closing the glass hatch

Check that the glass hatch is firmly closed. If it is not firmly closed, the rear window wiper and washer will not operate correctly.

■ Customization

The glass hatch opening operation can be changed.
(Customizable features: →P. 705)

 CAUTION

■ **While driving**

- Keep the glass hatch closed while driving.
If the glass hatch is left open, it may hit near-by objects while driving or luggage may be unexpectedly thrown out, causing an accident.
In addition, exhaust gases may enter the vehicle, causing death or a serious health hazard. Make sure to close the glass hatch before driving.
- Before driving the vehicle, make sure that the glass hatch is fully closed. If the glass hatch is not fully closed, it may open unexpectedly while driving, causing an accident.

■ **When children are in the vehicle**

Do not allow a child to open or close the glass hatch.
Doing so may cause the glass hatch to move unexpectedly, or cause the child's hands, head, or neck to be caught by the closing glass hatch.

■ **Operating the glass hatch**

- Observe the following precautions.
Failure to do so may cause parts of the body to be caught, resulting in death or serious injury.
- Remove any heavy loads, such as snow and ice, from the glass hatch before opening it. Failure to do so may cause the glass hatch suddenly shut again after it is opened.
 - When opening or closing the glass hatch, thoroughly check to make sure the surrounding area is safe.
 - If anyone is in the vicinity, make sure they are safe and let them know that the glass hatch is about to open or close.
 - Use caution when opening or closing the glass hatch in windy weather as it may move abruptly in strong wind.

CAUTION**■ Operating the glass hatch**

- The glass hatch may close if it is not opened fully. It is more difficult to open or close the glass hatch on an incline than on a level surface, so beware of the glass hatch unexpectedly opening or closing by itself. Make sure that the glass hatch is fully open and secure before using the luggage compartment.
- When closing the glass hatch, take extra care to prevent your fingers etc. from being caught.
- When closing the glass hatch, make sure to press it lightly on its outer surface.

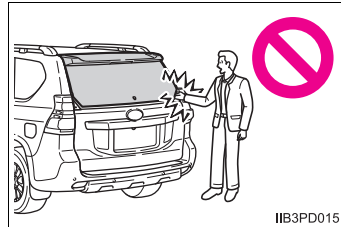

- Do not pull on the glass hatch damper stay to close the glass hatch, and do not hang on the glass hatch damper stay. Doing so may cause hands to be caught or the glass hatch damper stay to break, causing an accident.
- Do not attach any accessories other than genuine Toyota parts to the glass hatch. Such additional weight on the glass hatch may cause the glass hatch to suddenly shut again after it is opened.

 NOTICE

■ **Glass hatch damper stays**

The glass hatch is equipped with damper stays that hold the glass hatch in place.

Observe the following precautions.

Failure to do so may cause damage to the glass hatch damper stay, resulting in malfunction.

- Do not attach any foreign objects, such as strikers, plastic sheets, or adhesives to the damper stay rod.
- Do not touch the damper stay rod with gloves or other fabric items.
- Do not attach any accessories other than genuine Toyota parts to the glass hatch.
- Do not place your hand or foot on the damper stay or apply lateral forces to it.

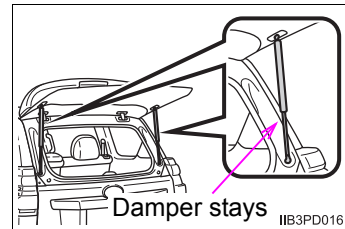

Smart entry & start system*

The following operations can be performed simply by carrying the electronic key on your person, for example in your pocket. The driver should always carry the electronic key.

- Locks and unlocks the side doors (→P. 131)
- Locks and unlocks the back door (→P. 141)
- Opens the glass hatch (→P. 148)
- Starts the engine (→P. 243)

■ Antenna location

- ① Antennas outside the cabin
- ② Antennas inside the cabin
- ③ Antenna outside the luggage compartment

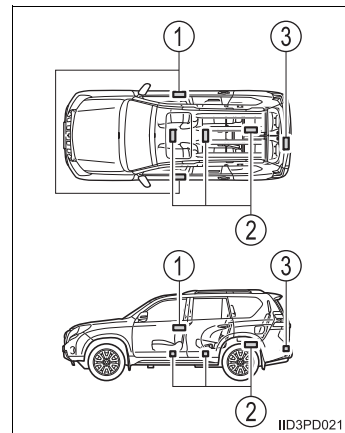

*: If equipped

■ **Effective range (areas within which the electronic key is detected)**

● When locking or unlocking the doors

The system can be operated when the electronic key is within about 0.7 m (2.3 ft.) of either of the outside front door handle. (Only the doors detecting the key can be operated.)

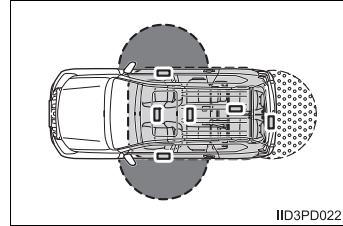

● When opening the glass hatch (if equipped) and locking or unlocking the back door

The system can be operated when the electronic key is within about 0.7 m (2.3 ft.) of the back door handle.

● When starting the engine or changing engine switch modes

The system can be operated when the electronic key is inside the vehicle.

Vehicles for U.K.: The system may not operate when the back door or the glass hatch are open, even if the electronic key is in the rear of the vehicle.

■ **Alarms and warning indicators**

Vehicles with the multi-information display type A: A combination of exterior and interior alarms as well as warning lights are used to prevent theft of the vehicle and unforeseeable accidents resulting from erroneous operation. Take appropriate measures for the warning light that comes on. (→P. 601)

Vehicles with the multi-information display type B: A combination of exterior and interior alarms as well as warning messages shown on the multi-information display are used to prevent theft of the vehicle and accidents resulting from erroneous operation. Take appropriate measures in response to any warning message on the multi-information display. (→P. 607)

The following table describes circumstances and correction procedures when only alarms are sounded.

Alarm	Situation	Correction procedure
Interior alarm pings once and exterior alarm sounds once for 5 seconds*1	An attempt was made to lock the doors using the smart entry & start system while the electronic key was still inside the vehicle.	Retrieve the electronic key from the vehicle and lock the doors again.
Exterior alarm sounds once for 5 seconds	An attempt was made to lock the vehicle while a door was open.	Close all of the doors and lock the doors again.
	An attempt was made to close the glass hatch while the electronic key was still inside the vehicle.	Open the glass hatch again and retrieve the electronic key from the vehicle.
Interior alarm pings continuously	The engine switch was turned to ACCESSORY mode while the driver's door was open (or the driver's door was opened while the engine switch was in ACCESSORY mode).	Turn the engine switch off and close the driver's door.
Interior alarm sounds continuously*1, 2	The driver's door was opened while any shift position other than P was selected without turning off the engine switch.	Shift the shift lever to P.
Interior alarm pings once*1	The electronic key has a low battery.	Replace the electronic key battery.

*1: Vehicles with the multi-information display type A

*2: Vehicles with an automatic transmission

■ Battery-saving function

The battery-saving function will be activated in order to prevent the electronic key battery and the vehicle battery from being discharged while the vehicle is not in operation for a long time.

- In the following situations, the smart entry & start system may take some time to unlock the doors.
 - The electronic key has been left in an area of approximately 2 m (6 ft.) of the outside of the vehicle for 10 minutes or longer.
 - The smart entry & start system has not been used for 5 days or longer.
- If the smart entry & start system has not been used for 14 days or longer, the doors cannot be unlocked at any doors except the driver's door. In this case, take hold of the driver's door handle, or use the wireless remote control or the mechanical key, to unlock the doors.

■ Conditions affecting operation

The smart entry & start system uses weak radio waves. In the following situations, the communication between the electronic key and the vehicle may be affected, preventing the smart entry & start system, wireless remote control and engine immobilizer system from operating properly.

(Ways of coping: →P. 660)

- When the electronic key battery is depleted
- Near a TV tower, electric power plant, gas station, radio station, large display, airport or other facility that generates strong radio waves or electrical noise
- When carrying a portable radio, cellular phone, cordless phone or other wireless communication device
- When the electronic key is in contact with, or is covered by the following metallic objects
 - Cards to which aluminum foil is attached
 - Cigarette boxes that have aluminum foil inside
 - Metallic wallets or bags
 - Coins
 - Hand warmers made of metal
 - Media such as CDs and DVDs
- When multiple electronic keys are in the vicinity
- When other wireless keys (that emit radio waves) are being used nearby
- When carrying the electronic key together with the following devices that emit radio waves
 - Another vehicle's electronic key or a wireless key that emits radio waves
 - Personal computers or personal digital assistants (PDAs)
 - Digital audio players
 - Portable game systems
- If window tint with a metallic content or metallic objects are attached to the rear window

■ Note for the entry function

- Even when the electronic key is within the effective range (detection areas), the system may not operate properly in the following cases:
 - The electronic key is too close to the window or outside door handle, near the ground, or in a high place when the doors are locked or unlocked.
 - The electronic key is near the ground or in a high place, or too close to the rear bumper center when the glass hatch is opened.
 - The electronic key is on the instrument panel, luggage cover or floor, or in the door pockets or glove box when the engine is started or engine switch modes are changed.
- Do not leave the electronic key on top of the instrument panel or near the door pockets when exiting the vehicle. Depending on the radio wave reception conditions, it may be detected by the antenna outside the cabin and the doors will become lockable from the outside, possibly trapping the electronic key inside the vehicle.
- As long as the electronic key is within the effective range, the doors may be locked or unlocked by anyone. However, only the doors detecting the electronic key can be used to unlock the vehicle.
- Even if the electronic key is not inside the vehicle, it may be possible to start the engine if the electronic key is near the window.
- The doors may lock or unlock if a large amount of water splashes on the door handle, such as in the rain or in a car wash, when the electronic key is within the effective range. (The doors will automatically be locked after approximately 30 seconds if the doors are not opened and closed.)
- If the wireless remote control is used to lock the doors when the electronic key is near the vehicle, there is a possibility that the door may not be unlocked by the entry function. (Use the wireless remote control to unlock the doors.)
- Touching the door lock sensor while wearing gloves may prevent lock operation.
- If the door handle becomes wet while the electronic key is within the effective range, the door may lock and unlock repeatedly. Place the electronic key in a location 2 m (6 ft.) or more away from the vehicle. (Take care to ensure that the key is not stolen.)
- If the electronic key is inside the vehicle and a door handle becomes wet during a car wash, a message may be shown on the multi-information display and a buzzer will sound outside the vehicle. To turn off the alarm, lock all the doors.

- The lock sensor may not work properly if it comes into contact with ice, snow, mud, etc. Clean the lock sensor and attempt to operate it again, or use the lock sensor on the lower part of the door handle.
- Fingernails may scrape against the door during operation of the door handle. Be careful not to injure fingernails or damage the surface of the door.
- A sudden approach to the effective range of door handle may prevent the doors from being unlocked. In this case, return the door handle to the original position and check that the doors unlock before pulling the door handle again.
- Unlocking the vehicle may take more time if another electronic key is within the effective range.

■ **When the vehicle is not driven for extended periods**

- To prevent theft of the vehicle, do not leave the electronic key within 2 m (6 ft.) of the vehicle.
- The smart entry & start system can be deactivated in advance. (→P. 705)

■ **To operate the system properly**

Make sure to carry the electronic key when operating the system. Do not get the electronic key too close to the vehicle when operating the system from the outside of the vehicle.

Depending on the position and holding condition of the electronic key, the key may not be detected correctly and the system may not operate properly. (The alarm may go off accidentally, or the door lock prevention function may not operate.)

■ **If the smart entry & start system does not operate properly**

- Locking and unlocking the doors: Use the mechanical key. (→P. 660)
- Starting the engine: →P. 661

■ Electronic key battery depletion

- The standard battery life is 1 to 2 years.
- If the battery becomes low, an alarm will sound in the cabin when the engine stops. (→P. 155, 620)
- As the electronic key always receives radio waves, the battery will become depleted even if the electronic key is not used. The following symptoms indicate that the electronic key battery may be depleted. Replace the battery when necessary. (→P. 559)
 - The smart entry & start system or the wireless remote control does not operate.
 - The detection area becomes smaller.
 - The LED indicator on the key surface does not turn on.
- To avoid serious deterioration, do not leave the electronic key within 1 m (3 ft.) of the following electrical appliances that produce a magnetic field:
 - TVs
 - Personal computers
 - Cellular phones, cordless phones and battery chargers
 - Recharging cellular phones or cordless phones
 - Table lamps
 - Induction cookers

■ Customization

Settings (e.g. smart entry & start system) can be changed.
(Customizable features →P. 705)

■ If the smart entry & start system has been deactivated in a customized setting

- Locking and unlocking the doors:
Use the wireless remote control or mechanical key. (→P. 132, 660)
- Starting the engine and changing engine switch modes: →P. 661
- Stopping the engine: →P. 245

■ **Certification for the smart entry & start system**

Hereby, Toyota Motor Corporation, declares that this TMLF8-15 is in compliance with the essential requirements and other relevant provisions of Directive 1999/5/EC.

TOYOTA

TOYOTA MOTOR CORPORATION

1, TOYOTA-CHO, TOYOTA, AICHI, 471-8571, JAPAN TEL: +81-565-28-2121

R&TTE Declaration of Conformity

We,

Manufacturer's Name: TOYOTA MOTOR CORPORATION
Manufacturer's Address: 1, Toyota -cho, Toyota, Aichi, 471-8572, Japan

hereby declare under our sole responsibility that the product:

Product Name: LF Oscillator
Product Model: TMLF8-15

to which this declaration relates is in conformity with the essential requirements and other relevant requirements of the R&TTE Directive (1999/5/EC). The product is compliant with the following standards and/or other normative documents:

-Health & safety requirements: EN 60950-1
-EMC requirements EN 301 489-01 & EN 301 489-03
-Effective uses of radio spectrum: EN 300 330-2

Supplementary information:

* CE mark	
* Member states intended for use	EU and EFTA

Date: February 25, 2013

Signature: 
Tetsuya Matsuo

Hereby, Toyota Motor Corporation, declares that this TMLF8-15 is in compliance with the essential requirements and other relevant provisions of Directive 1999/5/EC.
Toyota Motor Corporation vakuuttaa täten että TMLF8-15 tyyppinen laite on direktiivin 1999/5/EY oleellisten vaatimusten ja sitä koskevien direktiivin muiden ehtojen mukainen.
Hierbij verklaart Toyota Motor Corporation dat het toestel TMLF8-15 in overeenstemming is met de essentiële eisen en de andere relevante bepalingen van richtlijn 1999/5/EG.
Par la présente Toyota Motor Corporation déclare que l'appareil TMLF8-15 est conforme aux exigences essentielles et aux autres dispositions pertinentes de la directive 1999/5/CE.
Härmed intygar Toyota Motor Corporation att denna TMLF8-15 står i överensstämmelse med de väsentliga egenskapskrav och övriga relevanta bestämmelser som framgår av direktiv 1999/5/EG.
Undertegnede Toyota Motor Corporation erklærer herved, at følgende udstyr TMLF8-15 overholder de væsentlige krav og øvrige relevante krav i direktiv 1999/5/EF.
Hiermit erklärt Toyota Motor Corporation, dass sich das Gerät TMLF8-15 in Übereinstimmung mit den grundlegenden Anforderungen und den übrigen einschlägigen Bestimmungen der Richtlinie 1999/5/EG befindet.
ΜΕ ΤΗΝ ΠΑΡΟΥΣΑ Toyota Motor Corporation ΔΗΛΩΝΕΙ ΟΤΙ ΤΜΛΦ8-15 ΣΥΜΜΟΡΦΩΝΕΤΑΙ ΠΡΟΣ ΤΙΣ ΟΥΣΙΩΔΕΙΣ ΑΠΑΙΤΗΣΕΙΣ ΚΑΙ ΤΙΣ ΛΟΙΠΕΣ ΣΧΕΤΙΚΕΣ ΔΙΑΤΑΞΕΙΣ ΤΗΣ ΟΔΗΓΙΑΣ 1999/5/ΕΚ.
Con la presente Toyota Motor Corporation dichiara che questo TMLF8-15 è conforme ai requisiti essenziali ed alle altre disposizioni pertinenti stabilite dalla direttiva 1999/5/CE.
Por medio de la presente Toyota Motor Corporation declara que el TMLF8-15 cumple con los requisitos esenciales y cualesquiera otras disposiciones aplicables o exigibles de la Directiva 1999/5/CE.
Toyota Motor Corporation declara que este TMLF8-15 está conforme com os requisitos essenciais e outras disposições da Directiva 1999/5/CE.
Hawnhekk, Toyota Motor Corporation, jiddikjara li dan TMLF8-15 jikkonforma mal-htigijiet essenzjali u ma provvedimenti oħrajn relevanti li hemm fid-Dirrettiva 1999/5/EC.
Käesolevaga kinnitab Toyota Motor Corporation seadme TMLF8-15 vastavust direktiivi 1999/5/EÜ põhiohuetele ja nimetatud direktiivist tulenevatele teistele asjakohastele sätetele.
Alulírott, Toyota Motor Corporation nyilatkozom, hogy a TMLF8-15 megfelel a vonatkozó alapvető követelményeknek és az 1999/5/EC irányelv egyéb előírásainak.



Index

<p>Toyota Motor Corporation týmto vyhlasuje, že TMLF8-15 spĺňa základné požiadavky a všetky príslušné ustanovenia Smernice 1999/5/ES.</p>
<p>Toyota Motor Corporation tímto prohlašuje, že tento TMLF8-15 je ve shodě se základními požadavky a dalšími příslušnými ustanoveními směrnice 1999/5/ES.</p>
<p>Toyota Motor Corporation izjavlja, da je ta TMLF8-15 v skladu z bistvenimi zahtevami in ostalimi relevantnimi določili direktive 1999/5/ES.</p>
<p>Šiuo Toyota Motor Corporation deklaruoja, kad šis TMLF8-15 atitinka esminius reikalavimus ir kitas 1999/5/EB Direktyvos nuostatas.</p>
<p>Ar šo Toyota Motor Corporation deklarē, ka TMLF8-15 atbilst Direktīvas 1999/5/EK būtiskajām prasībām un citiem ar to saistītajiem noteikumiem.</p>
<p>Niniejszym Toyota Motor Corporation oświadcza, że TMLF8-15 jest zgodny z zasadniczymi wymogami oraz pozostałymi stosownymi postanowieniami Dyrektywy 1999/5/EC.</p>
<p>Hér með lýsir Toyota Motor Corporation yfir því að TMLF8-15 er í samræmi við grunnkröfur og aðrar kröfur, sem gerðar eru í tilskipun 1999/5/EC.</p>
<p>Toyota Motor Corporation erklærer herved at utstyret TMLF8-15 er i samsvar med de grunnleggende krav og øvrige relevante krav i direktiv 1999/5/EF.</p>
<p>С настоящето, Toyota Motor Corporation, декларира, че TMLF8-15 е в съответствие със съществените изисквания и другите приложими разпоредби на Директива 1999/5/EC.</p>
<p>Prin prezenta, Toyota Motor Corporation, declară că aparatul TMLF8-15 este în conformitate cu cerințele esențiale și cu alte prevederi pertinente ale Directivei 1999/5/CE.</p>
<p>Ovim, Toyota Motor Corporation, izjavljuje da ovaj TMLF8-15 je usklađen sa bitnim zahtjevima i drugim relevantnim odredbama Direktive 1999/5/EC.</p>
<p>Nepermjet kesaj, Toyota Motor Corporation, deklaroj qe ky TMLF8-15 eshte ne pajtim me kerkesat thelbesore dhe dispozitat e tjera perkatese te Direktives 1999/5/EC.</p>
<p>Ovim Toyota Motor Corporation, izjavljuje da je TMLF8-15 u skladu s bitnim zahtjevima i drugim relevantnim odredbama Direktive 1999/5/EC i Pravilnika o RiTT opremi (NN 25/2012).</p>
<p>Ovim, Toyota Motor Corporation, deklarirše da je TMLF8-15 u skladu sa osnovnim zahtevima i ostalim relevantnim odredbama Direktive 1999/5/EC.</p>

Hereby, Tokai Rika Co., Ltd., declares that this B74EA is in compliance with the essential requirements and other relevant provisions of Directive 1999/5/EC.

The DECLARATION of CONFORMITY (DoC) is available at the following address:

<http://www.tokai-rika.co.jp/pc/>



<p>Hereby, Tokai Rika Co., Ltd., declares that this B74EA is in compliance with the essential requirements and other relevant provisions of Directive 1999/5/EC.</p>
<p>Tokai Rika Co., Ltd. vakuuttaa täten että B74EA tyyppinen laite on direktiivin 1999/5/EY oleellisten vaatimusten ja sitä koskevien direktiivin muiden ehtojen mukainen.</p>
<p>Hierbij verklaart Tokai Rika Co., Ltd. dat het toestel B74EA in overeenstemming is met de essentiële eisen en de andere relevante bepalingen van richtlijn 1999/5/EG.</p>
<p>Par la présente Tokai Rika Co., Ltd. déclare que l'appareil B74EA est conforme aux exigences essentielles et aux autres dispositions pertinentes de la directive 1999/5/CE.</p>
<p>Härmed intygar Tokai Rika Co., Ltd. att denna B74EA står i överensstämmelse med de väsentliga egenskapskrav och övriga relevanta bestämmelser som framgår av direktiv 1999/5/EG.</p>
<p>Undertegnede Tokai Rika Co., Ltd. erklærer herved, at følgende udstyr B74EA overholder de væsentlige krav og øvrige relevante krav i direktiv 1999/5/EF.</p>
<p>Hiermit erklärt Tokai Rika Co., Ltd., dass sich das Gerät B74EA in Übereinstimmung mit den grundlegenden Anforderungen und den übrigen einschlägigen Bestimmungen der Richtlinie 1999/5/EG befindet.</p>
<p>ΜΕ ΤΗΝ ΠΑΡΟΥΣΑ Tokai Rika Co., Ltd. ΔΗΛΩΝΕΙ ΟΤΙ Β74ΕΑ ΣΥΜΜΟΡΦΟΝΕΤΑΙ ΠΡΟΣ ΤΙΣ ΟΥΣΙΩΔΕΙΣ ΑΠΑΙΤΗΣΕΙΣ ΚΑΙ ΤΙΣ ΛΟΙΠΕΣ ΣΧΕΤΙΚΕΣ ΔΙΑΤΑΞΕΙΣ ΤΗΣ ΟΔΗΓΙΑΣ 1999/5/ΕΚ.</p>
<p>Con la presente Tokai Rika Co., Ltd. dichiara che questo B74EA è conforme ai requisiti essenziali ed alle altre disposizioni pertinenti stabilite dalla direttiva 1999/5/CE.</p>
<p>Por medio de la presente Tokai Rika Co., Ltd. declara que el B74EA cumple con los requisitos esenciales y cualesquiera otras disposiciones aplicables o exigibles de la Directiva 1999/5/CE.</p>
<p>Tokai Rika Co., Ltd. declara que este B74EA está conforme com os requisitos essenciais e outras disposições da Directiva 1999/5/CE.</p>
<p>Hawnhekk, Tokai Rika Co., Ltd., jiddikjara li dan B74EA jikkonforma mal-htigijiet essenzjali u ma provvedimenti oħrajn relevanti li hemm fid-Dirrettiva 1999/5/EC.</p>
<p>Käesolevaga kinnitab Tokai Rika Co., Ltd. seadme B74EA vastavust direktiivi 1999/5/EÜ põhinõuetele ja nimetatud direktiivist tulenevatele teistele asjakohastele sätetele.</p>
<p>Alulírott, Tokai Rika Co., Ltd. nyilatkozom, hogy a B74EA megfelel a vonatkozó alapvető követelményeknek és az 1999/5/EC irányelv egyéb előírásainak.</p>

Tokai Rika Co., Ltd. týmto vyhlasuje, že B74EA spĺňa základné požiadavky a všetky príslušné ustanovenia Smernice 1999/5/ES.
Tokai Rika Co., Ltd. tímto prohlašuje, že tento B74EA je ve shodě se základními požadavky a dalšími příslušnými ustanoveními směrnice 1999/5/ES.
Tokai Rika Co., Ltd. izjavlja, da je ta B74EA v skladu z bistvenimi zahtevami in ostalimi relevantnimi določili direktive 1999/5/ES.
Šiuo Tokai Rika Co., Ltd. deklaruoja, kad šis B74EA atitinka esminius reikalavimus ir kitas 1999/5/EB Direktyvos nuostatas.
Ar šo Tokai Rika Co., Ltd. deklarē, ka B74EA atbilst Direktīvas 1999/5/EK būtiskajām prasībām un citiem ar to saistītajiem noteikumiem.
Niniejszym Tokai Rika Co., Ltd. oświadcza, że B74EA jest zgodny z zasadniczymi wymogami oraz pozostałymi stosownymi postanowieniami Dyrektywy 1999/5/EC.
Hér með lýsir Tokai Rika Co., Ltd. yfir því að B74EA er í samræmi við grunnkröfur og aðrar kröfur, sem gerðar eru í tilskipun 1999/5/EC.
Tokai Rika Co., Ltd. erklærer herved at utstyret B74EA er i samsvar med de grunnleggende krav og øvrige relevante krav i direktiv 1999/5/EF.
С настоящето, Tokai Rika Co., Ltd., декларира, че B74EA е в съответствие със съществените изисквания и другите приложими разпоредби на Директива 1999/5/EC.
Prin prezenta, Tokai Rika Co., Ltd., declară că aparatul B74EA este în conformitate cu cerințele esențiale și cu alte prevederi pertinente ale Directivei 1999/5/CE.
Ovim, Tokai Rika Co., Ltd., izjavlja da ovaj B74EA je usklađen sa bitnim zahtjevima i drugim relevantnim odredbama Direktive 1999/5/EC.
Nepermjet kesaj, Tokai Rika Co., Ltd., deklaroj qe ky B74EA eshte ne pajtim me kerkesat thelbesore dhe dispozitat e tjera perkatese te Direktives 1999/5/EC.
Ovim Tokai Rika Co., Ltd., izjavlja da je B74EA u skladu s bitnim zahtjevima i drugim relevantnim odredbama Direktive 1999/5/EC i Pravilnika o RITT opremi (NN 25/2012).
Ovim, Tokai Rika Co., Ltd., deklarirše da je B74EA u skladu sa osnovnim zahtevima i ostalim relevantnim odredbama Direktive 1999/5/EC.

Hereby, Tokai Rika Co., Ltd., declares that this B72UA is in compliance with the essential requirements and other relevant provisions of Directive 1999/5/EC.

The DECLARATION of CONFORMITY (DoC) is available at the following address:

<http://www.tokai-rika.co.jp/pc/>



Hereby, Tokai Rika Co., Ltd., declares that this B72UA is in compliance with the essential requirements and other relevant provisions of Directive 1999/5/EC.
Tokai Rika Co., Ltd. vakuuttaa täten että B72UA tyyppinen laite on direktiivin 1999/5/EY oleellisten vaatimusten ja sitä koskevien direktiivin muiden ehtojen mukainen.
Hierbij verklaart Tokai Rika Co., Ltd. dat het toestel B72UA in overeenstemming is met de essentiële eisen en de andere relevante bepalingen van richtlijn 1999/5/EG.
Par la présente Tokai Rika Co., Ltd. déclare que l'appareil B72UA est conforme aux exigences essentielles et aux autres dispositions pertinentes de la directive 1999/5/CE.
Härmed intygar Tokai Rika Co., Ltd. att denna B72UA står i överensstämmelse med de väsentliga egenskapskrav och övriga relevanta bestämmelser som framgår av direktiv 1999/5/EG.
Undertegnede Tokai Rika Co., Ltd. erklærer herved, at følgende udstyr B72UA overholder de væsentlige krav og øvrige relevante krav i direktiv 1999/5/EF.
Hiermit erklärt Tokai Rika Co., Ltd., dass sich das Gerät B72UA in Übereinstimmung mit den grundlegenden Anforderungen und den übrigen einschlägigen Bestimmungen der Richtlinie 1999/5/EG befindet.
ΜΕ ΤΗΝ ΠΑΡΟΥΣΑ Tokai Rika Co., Ltd. ΔΗΛΩΝΕΙ ΟΤΙ Β72UA ΣΥΜΜΟΡΦΩΝΕΤΑΙ ΠΡΟΣ ΤΙΣ ΟΥΣΙΩΔΕΙΣ ΑΠΑΙΤΗΣΕΙΣ ΚΑΙ ΤΙΣ ΛΟΙΠΕΣ ΣΧΕΤΙΚΕΣ ΔΙΑΤΑΞΕΙΣ ΤΗΣ ΟΔΗΓΙΑΣ 1999/5/ΕΚ.
Con la presente Tokai Rika Co., Ltd. dichiara che questo B72UA è conforme ai requisiti essenziali ed alle altre disposizioni pertinenti stabilite dalla direttiva 1999/5/CE.
Por medio de la presente Tokai Rika Co., Ltd. declara que el B72UA cumple con los requisitos esenciales y cualesquiera otras disposiciones aplicables o exigibles de la Directiva 1999/5/CE.
Tokai Rika Co., Ltd. declara que este B72UA está conforme com os requisitos essenciais e outras disposições da Directiva 1999/5/CE.
Hawnhekk, Tokai Rika Co., Ltd., jiddikjara li dan B72UA jikkonforma mal-htigijiet essenzjali u ma provvedimenti oħrajn rilevanti li hemm fid-Direttiva 1999/5/EC.
Käesolevaga kinnitab Tokai Rika Co., Ltd. seadme B72UA vastavust direktiivi 1999/5/EÜ põhinõuetele ja nimetatud direktiivist tulenevatele teistele asjakohastele sätetele.
Alulírott, Tokai Rika Co., Ltd. nyilatkozom, hogy a B72UA megfelel a vonatkozó alapvető követelményeknek és az 1999/5/EC irányelv egyéb előírásainak.

Tokai Rika Co., Ltd. týmto vyhlasuje, že B72UA spĺňa základné požiadavky a všetky príslušné ustanovenia Smernice 1999/5/ES.
Tokai Rika Co., Ltd. tímto prohlašuje, že tento B72UA je ve shodě se základními požadavky a dalšími příslušnými ustanoveními směrnice 1999/5/ES.
Tokai Rika Co., Ltd. izjavlja, da je ta B72UA v skladu z bistvenimi zahtevami in ostalimi relevantnimi določili direktive 1999/5/ES.
Šiuo Tokai Rika Co., Ltd. deklaruoja, kad šis B72UA atitinka esminius reikalavimus ir kitas 1999/5/EB Direktyvos nuostatas.
Ar šo Tokai Rika Co., Ltd. deklarē, ka B72UA atbilst Direktīvas 1999/5/EK būtiskajām prasībām un citiem ar to saistītajiem noteikumiem.
Niniejszym Tokai Rika Co., Ltd. oświadcza, że B72UA jest zgodny z zasadniczymi wymogami oraz pozostałymi stosownymi postanowieniami Dyrektywy 1999/5/EC.
Hér með lýsir Tokai Rika Co., Ltd. yfir því að B72UA er í samræmi við grunnkröfur og aðrar kröfur, sem gerðar eru í tilskipun 1999/5/EC.
Tokai Rika Co., Ltd. erklærer herved at utstyret B72UA er i samsvar med de grunnleggende krav og øvrige relevante krav i direktiv 1999/5/EF.
С настоящето, Tokai Rika Co., Ltd., декларира, че B72UA е в съответствие със съществените изисквания и другите приложими разпоредби на Директива 1999/5/EC.
Prin prezenta, Tokai Rika Co., Ltd., declară că aparatul B72UA este în conformitate cu cerințele esențiale și cu alte prevederi pertinente ale Directivei 1999/5/CE.
Ovim, Tokai Rika Co., Ltd., izjavlja da ovaj B72UA je usklađen sa bitnim zahtjevima i drugim relevantnim odredbama Direktive 1999/5/EC.
Nepermjet kesaj, Tokai Rika Co., Ltd., deklaroj qe ky B72UA eshte ne pajtim me kerkesat thelbesore dhe dispozitat e tjera perkatese te Direktives 1999/5/EC.
Ovim Tokai Rika Co., Ltd., izjavlja da je B72UA u skladu s bitnim zahtjevima i drugim relevantnim odredbama Direktive 1999/5/EC i Pravilnika o RITT opremi (NN 25/2012).
Ovim, Tokai Rika Co., Ltd., deklarirše da je B72UA u skladu sa osnovnim zahtevima i ostalim relevantnim odredbama Direktive 1999/5/EC.

 CAUTION**■ Caution regarding interference with electronic devices**

- People with implantable cardiac pacemakers, cardiac resynchronization therapy-pacemakers or implantable cardioverter defibrillators should maintain a reasonable distance between themselves and the smart entry & start system antennas. (→P. 155)

The radio waves may affect the operation of such devices. If necessary, the entry function can be disabled. Ask any authorized Toyota dealer or repairer, or another duly qualified and equipped professional for details, such as the frequency of radio waves and timing of the emitted radio waves. Then, consult your doctor to see if you should disable the entry function.

- Users of any electrical medical device other than implantable cardiac pacemakers, cardiac resynchronization therapy-pacemakers or implantable cardioverter defibrillators should consult the manufacturer of the device for information about its operation under the influence of radio waves.

Radio waves could have unexpected effects on the operation of such medical devices.

Ask any authorized Toyota dealer or repairer, or another duly qualified and equipped professional for details on disabling the entry function.

Front seats

Adjustment procedure

► Manual seat

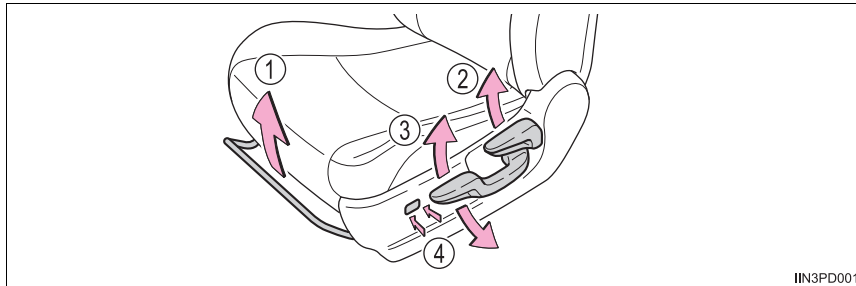

- ① Seat position adjustment lever
- ② Seatback angle adjustment lever
- ③ Vertical height adjustment lever (driver's side only)
- ④ Lumbar support adjustment switch (driver's side only)

► Power seat (driver's side only)

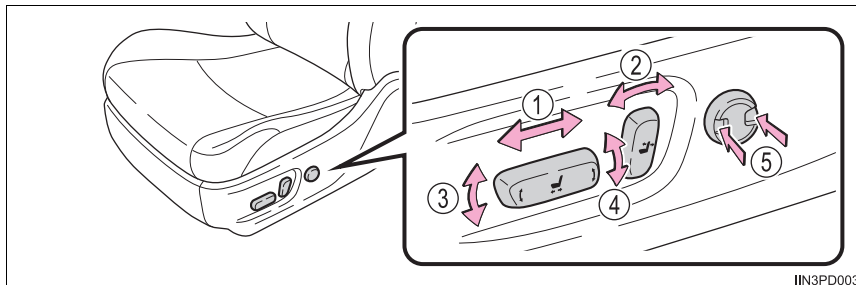

- ① Seat position adjustment switch
- ② Seatback angle adjustment switch
- ③ Seat cushion (front) angle adjustment switch (driver's side only)
- ④ Vertical height adjustment switch (driver's side only)
- ⑤ Lumbar support adjustment switch (driver's side only)

Active head restraints

When the occupant's lower back presses against the seatback during a rear-end collision, the head restraint moves slightly forward and upward to help reduce the risk of whiplash on the seat occupant.

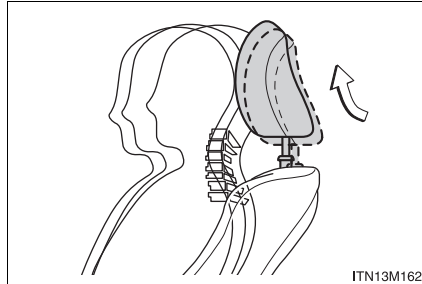

ITN13M162

Moving a front passenger's seat for second seat access (3-door models)

■ Getting in the vehicle

Pull the seatback angle adjustment lever and fold down the seatback. The seat will slide forward.

Move the seat to the front-most position

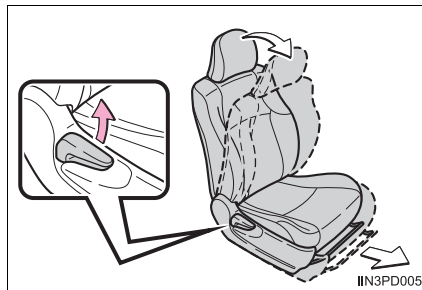

IIN3PD005

■ Getting out of the vehicle

Depress the release pedal and fold down the seatback. The seat will slide forward.

Move the seat to the front-most position

Make sure that no passenger is seated on the front passenger seat before depressing the release pedal.

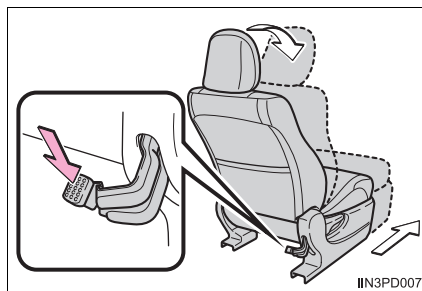

IIN3PD007

■ After passengers have entered/exited the vehicle

Lift up the seatback and slide the seat backward until it locks.

■ Active head restraints

Even small forces applied to the seatback may cause the head restraint to move. Pushing up a locked head restraint forcibly may appear the head restraint inner structure. These do not indicate problems.

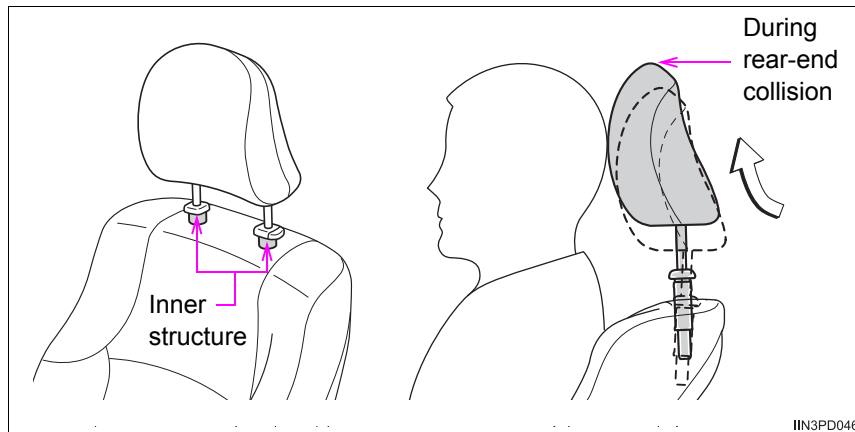

⚠ CAUTION

■ When adjusting the seat position

- Take care when adjusting the seat position to ensure that other passengers are not injured by the moving seat.
- Do not put your hands under the seat or near the moving parts to avoid injury.
Fingers or hands may become jammed in the seat mechanism.

■ Seat adjustment

- To reduce the risk of sliding under the lap belt during a collision, do not recline the seat more than necessary.
If the seat is too reclined, the lap belt may slide past the hips and apply restraint forces directly to the abdomen, or your neck may contact the shoulder belt, increasing the risk of death or serious injury in the event of an accident.
Adjustments should not be made while driving as the seat may unexpectedly move and cause the driver to lose control of the vehicle.
- After adjusting the seat, make sure that the seat is locked in position.
(manual seat only)

Rear seats*

Adjustment procedure

- ▶ Second seats (3-door models) (if equipped)

Seatback angle adjustment lever

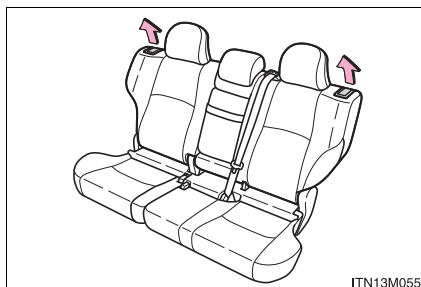

- ▶ Second seats (5-door models without third seats and vehicles with longitudinal type seats) (if equipped)

Seatback angle adjustment lever

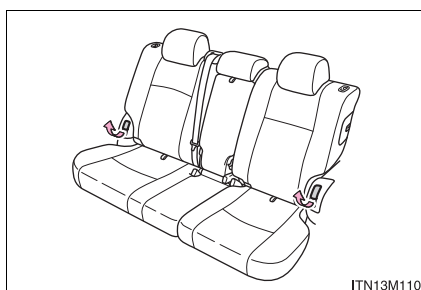

- ▶ Second seats (5-door models with third seats) (if equipped)

- ① Seatback angle adjustment lever
- ② Seat position adjustment lever

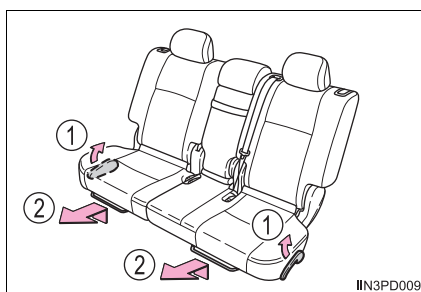

*: If equipped

▶ Third seats (power seat) (if equipped)

Seatback angle adjustment switch

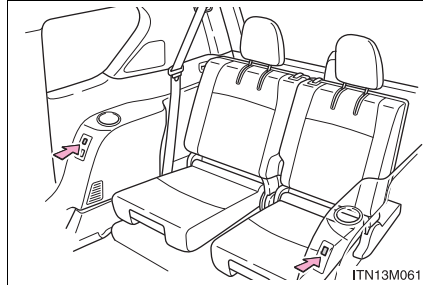

Moving a second seat for third seat access (5-door models with third seats)

■ **Getting in the vehicle (right side only [left-hand drive vehicles] or left side only [right-hand drive vehicles])**

Pull the seatback angle adjustment lever and fold down the seatback. The seat will slide forward.

Move the seat to the front-most position

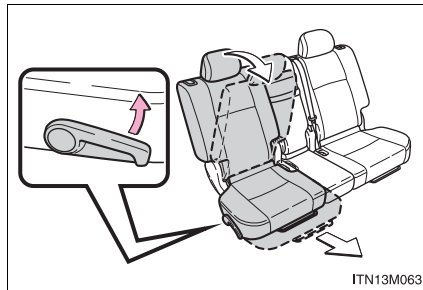

■ **Getting out of the vehicle (right side only [left-hand drive vehicles] or left side only [right-hand drive vehicles])**

Pull the release lever and fold down the seatback. The seat will slide forward.

Move the seat to the front-most position

Make sure that no passenger is seated on the second seat before pulling the release lever.

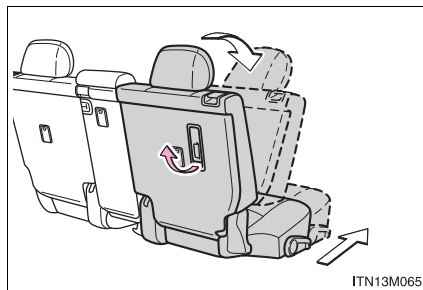

■ **After passengers have entered/exited the vehicle**

Lift up the seatback and slide the seat backward until it locks.

Tumbling the second seats (3-door models)**■ Before tumbling the second seats**

Lower the head restraints to the lowest position.

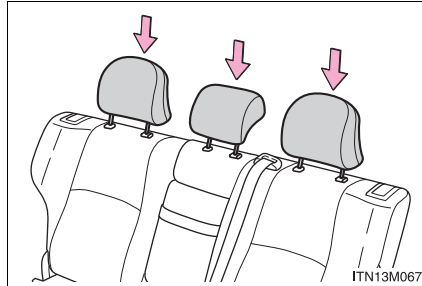

Use the seat belt hangers to prevent the belts from being tangled.

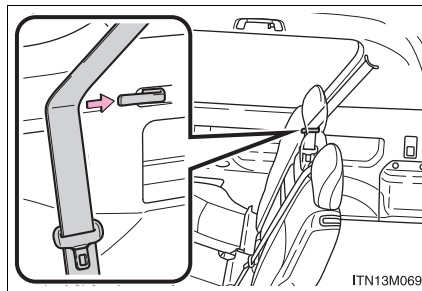

■ **Tumbling the second seats**

- 1 Pull the seatback angle lever and fold them down.

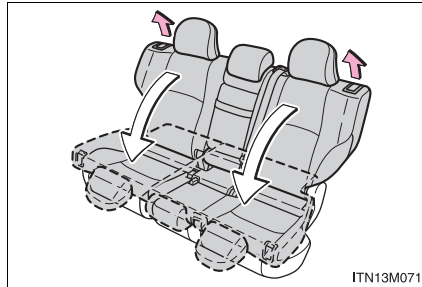

- 2 Pull the seat lock release lever on the back and swing the whole seat up and forward.

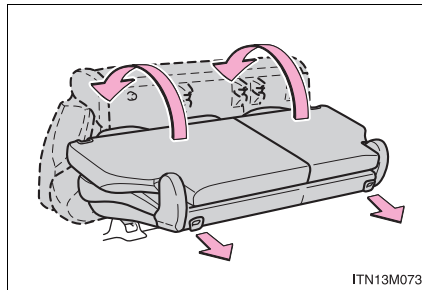

■ **Returning the second seats**

Push the knob to unlock the seat, swing the whole seat down and swing the seatback up.

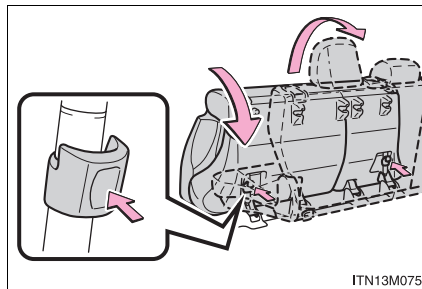

Folding down the second seatbacks (5-door models without third seats and vehicles with longitudinal type seats)

■ Before folding down the second seatbacks

Stow the center seat belt buckle with the hook-and-loop fastener and lower the head restraints to the lowest position.

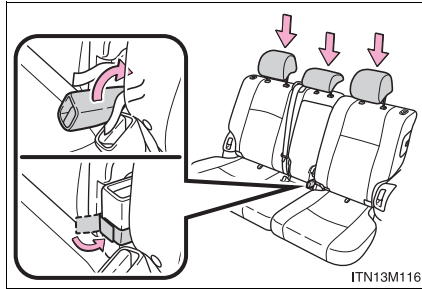

■ Folding down second seatbacks

- 1 Swing the bottom cushion up by pulling the lock release strap.

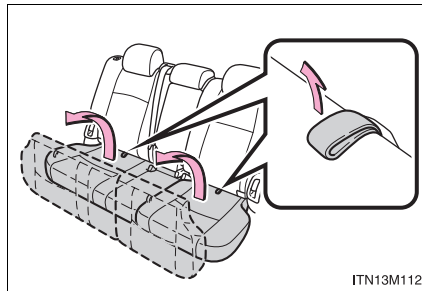

- 2 Push the seatback lock release button and fold them down.

To return the second seatbacks to their original positions, lift them up until they lock.

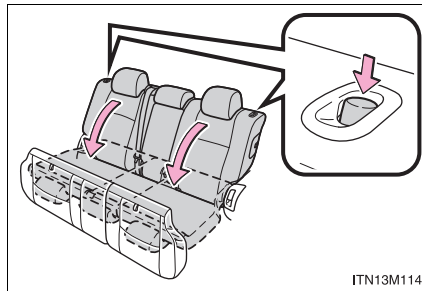

Folding down the second seatbacks (5-door models with third seats)

■ **Before folding down the second seatbacks**

Lower the head restraints to the lowest position.

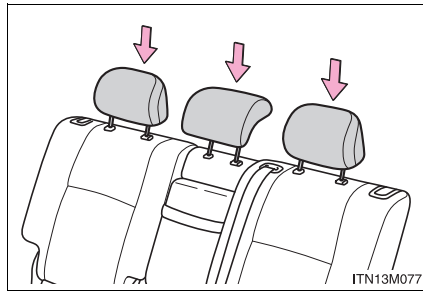

■ **Folding down second seatbacks**

Pull the seatback lock release lever and fold them down.

To return the second seatbacks to their original positions, lift them up until they lock.

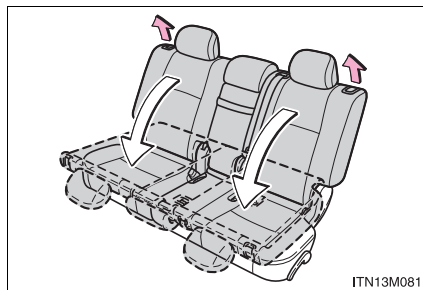

■ Folding down second center seatback only (5-door models)

Pull the center seatback lock release lever behind the seatback and fold it down.

To return the center seatback to its original position, lift it up until it locks.

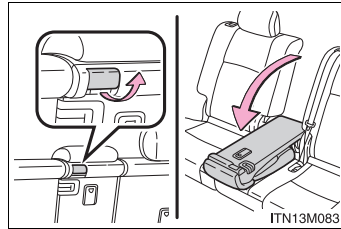
**■ If you cannot raise the seatback**

Release the seat belt lock by:

- ① Pushing on the lower front edge of the seatback to slacken the seat belt.
- ② Let the seat belt retract a little.

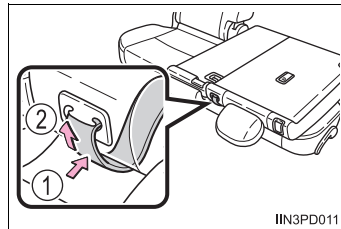

Folding the third seats (longitudinal type seat)

■ Folding the third seats

- 1 Swing the seat cushion fully up.

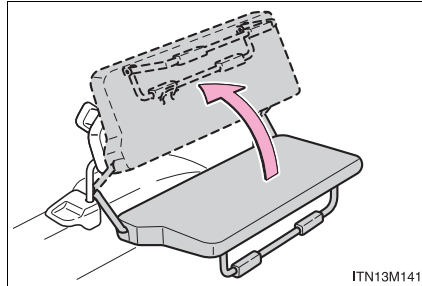

- 2 Take the holding strap of its pocket on the back of the seatback and secure the seat hooking the strap onto the hook in the back of the seat cushion.

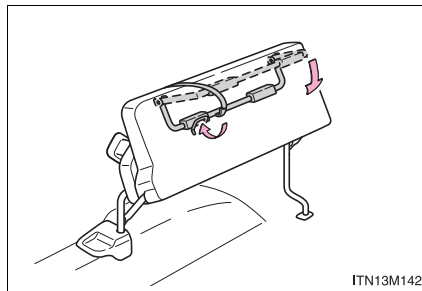

■ Returning the third seats

Reverse the steps above.

Folding down the third seats (manual seat)**■ Before folding down the third seats**

Lower the head restraints to the lowest position.

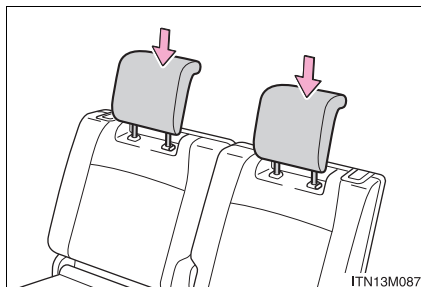

Use the seat belt hangers to prevent the belts from being tangled.

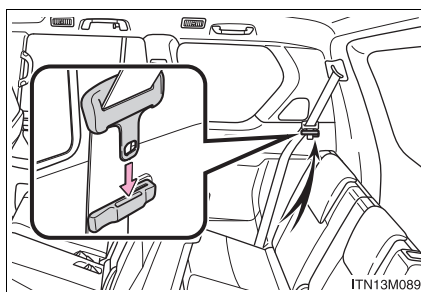
**■ Folding down the third seats****► From back door side**

Pull the seat cushion/seatback lock release lever and fold the seatback down.

The seat cushion is stowed automatically.

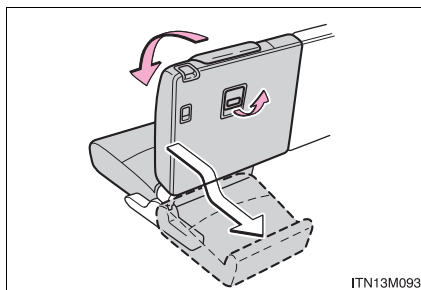

► From rear door side

- 1 Pull the seat cushion lock release lever.
The seat cushion is stowed automatically.

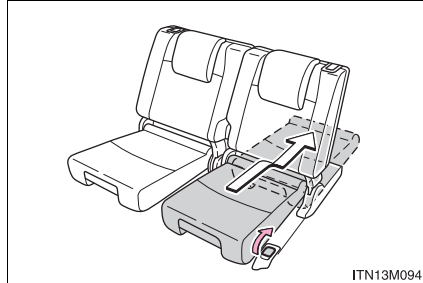

- 2 Pull the seatback lock release lever and fold them down.

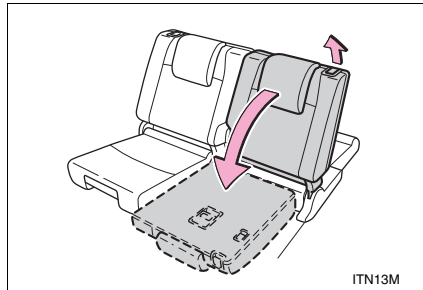

■ Returning the third seats

- 1 From rear door side, unlock the seatbacks by pulling the lock release lever, and lift them up until they lock.

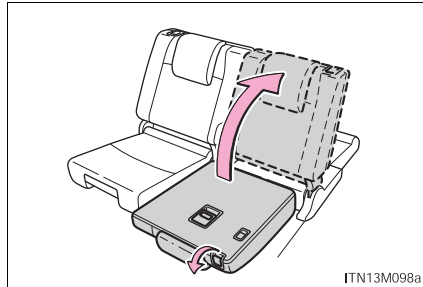

- 2 Pull the grip and carry the seat cushions out.

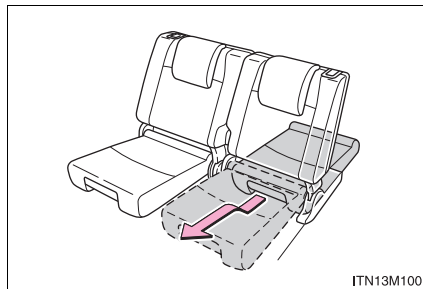

Folding down the third seats (power seat)

▶ Left-hand drive vehicles

▶ Right-hand drive vehicles

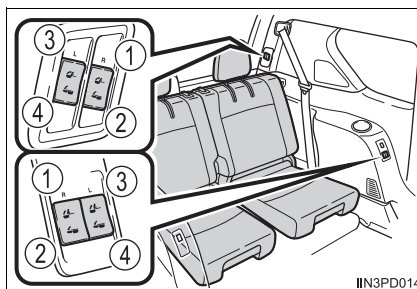
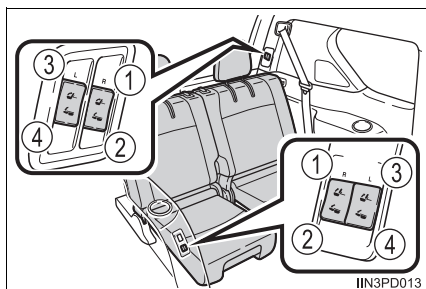

- ① Right seat return switch
- ② Right seat fold switch
- ③ Left seat return switch
- ④ Left seat fold switch

The switches can be operated from both the rear door side and the back door side.

■ Before folding down the third seats

Use the seat belt hangers to prevent the belts from being tangled.

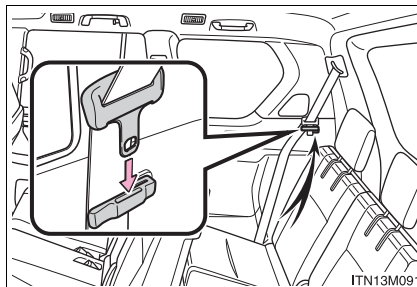

■ **Folding down the third seats**

- 1 Press and hold . Two beeps sound and the seat-back will rise.

When operating is completed, two beeps sound again.

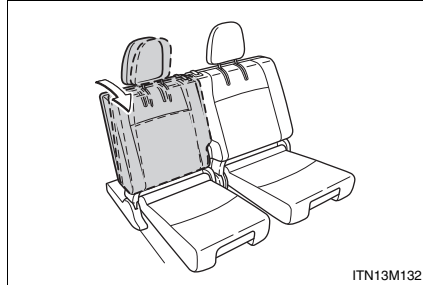

- 2 Press and hold  again.

Two beeps sound, the head restraints will fold forward, and the seat will be stowed.

When operating is completed, two beeps sound again.

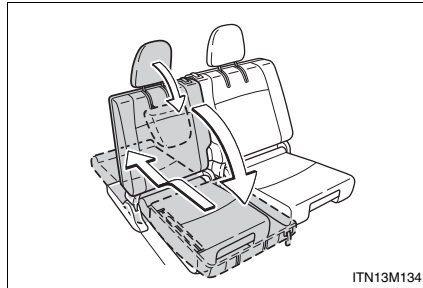

■ **Returning the third seats**

- 1 Press and hold . Two beeps sound and seat-back and seat cushion begin to move. When operating is completed, two beeps sound again.

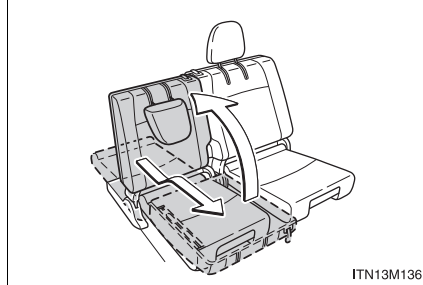

- 2 Lift the head restraints up until they lock.

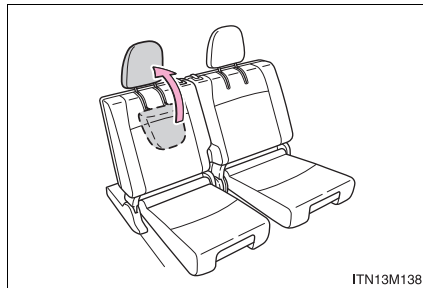

■ The third power seats can be operated when

- The engine switch is off.
- The shift lever is in P position (vehicles with an automatic transmission) or the parking brake is applied (vehicles with a manual transmission) with the engine switch in IGNITION ON mode.

■ During third power seat stowing operation

Do not remove your hand from the switch until the operation stops automatically. If you remove your hand from the switch, the operation will stop and the buzzer will sound continuously. The buzzer will stop when the switch is pressed again.

■ Enlarging the luggage compartment (vehicles with third power seats)

The third seat can be used for sitting when it is in the position shown in step 2 of the folding down the third seats. (→P. 184)

This can be convenient for enlarging the luggage compartment, for instance when the luggage is against the back of the seatback.

■ If the warning buzzer sounds continuously (vehicles with third power seats)





If there is an abnormality in the system, the warning buzzer will sound continuously while the engine switch is in IGNITION ON mode. In this case, perform the following operations:

1 Press and hold  to return the seat.

2 Press and hold  to stow the seat.

For each step, wait until the seat movement stops automatically and the two beeps sound twice before removing your hand from the switch.

If the warning buzzer does not stop even after performing the above procedure correctly, perform the following operations:

- 3 Press and hold  on the rear door side.
- 4 While holding , press forward on  5 times within 10 seconds and keep holding  until 3 beeps sound. The beep will then sound continuously again.
- 5 Repeat step 1 and 2.

⚠ CAUTION**■ When folding the seatbacks down**

Observe the following precautions. Failure to do so may result in death or serious injury.

- Do not fold the seatbacks down while driving.
- Stop the vehicle on level ground, set the parking brake and shift the shift lever to P (automatic transmission) or N (manual transmission).
- Do not allow anyone to sit on a folded seatback or in the luggage compartment while driving.
- Do not allow children to enter the luggage compartment.

■ Seat adjustment

Observe the following precautions. Failure to do so may result in death or serious injury.

- To reduce the risk of sliding under the lap belt during a collision, do not recline the seat more than necessary.
If the seat is too reclined, the lap belt may slide past the hips and apply restraint forces directly to the abdomen, or your neck may contact the shoulder belt, increasing the risk of death or serious injury in the event of an accident.
Adjustments should not be made while driving as the seat may unexpectedly move and cause the driver to lose control of the vehicle.
- Be careful not to get hands or feet pinched between the rear console box and the second seat when folding down the seatback.

 CAUTION**■ When stowing the third seats**

Observe the following precautions. Failure to do so may result in death or serious injury.

- Check that there is no luggage and that there are no other people around the seat before stowing operation.
- Conduct the procedure slowly and carefully (vehicles with manual third seats).
- Do not insert hands or feet into the moving parts of the seat.
- Do not allow children to operate the seat.
- Do not use the seat if only the seat cushion has been stowed (vehicles with manual third seats).

■ After returning the seatbacks to the upright position

Observe the following precautions. Failure to do so may result in death or serious injury.

- Make sure the seatback is securely locked by pushing it forward and rearward on the top. (except for third power seats)
- Check that the seat belts are not twisted or caught in the seatback.

 NOTICE**■ When returning the third seat (vehicles with a luggage cover)**

If the luggage cover is installed in the luggage compartment, make sure you remove it before returning the third seat (→P. 492). The luggage cover may be damaged by the seat.

Driving position memory*

This feature automatically adjusts the driver's seats and steering wheel to make entering and exiting the vehicle easier or to suit your preferences.

Driving position memory

Your preferred driving position (the position of the driver's seat and steering wheel) can be memorized and recalled with the touch of a button.

Two different driving positions can be entered into memory.

■ Recording procedure

- 1 Vehicles with an automatic transmission:
Check that the shift lever is in P.
Vehicles with a manual transmission:
Check that the parking brake is set.
- 2 Vehicles without a smart entry & start system:
Turn the engine switch to the "ON" position.
Vehicles with a smart entry & start system:
Turn the engine switch to IGNITION ON mode.
- 3 Adjust the driver's seat and steering wheel to the desired positions.
- 4 While pressing the "SET" button, or within 3 seconds after the "SET" button is pressed, press button "1" or "2" until the buzzer sounds.

If the selected button has already been preset, the previously recorded position will be overwritten.

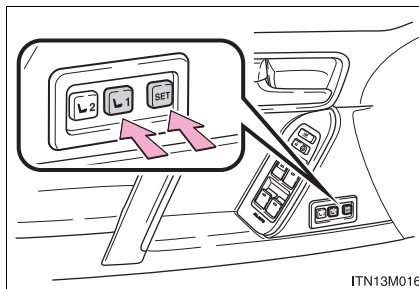

*: If equipped

■ Recall procedure

- 1 Vehicles with an automatic transmission:
Check that the shift lever is in P.
Vehicles with a manual transmission:
Check that the parking brake is set.
- 2 Vehicles without a smart entry & start system:
Turn the engine switch to the "ON" position.
Vehicles with a smart entry & start system:
Turn the engine switch to IGNITION ON mode.
- 3 Press button "1" or "2" for the driving position you want to recall until the buzzer sounds.

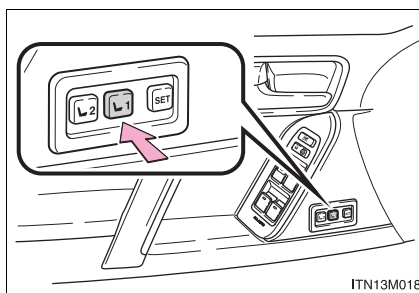

■ To stop the position recall operation part-way through

Perform any of the following:

- Press the "SET" button.
- Press button "1" or "2".
- Operate any of the seat adjustment switches (only cancels seat position recall).
- Operate the tilt and telescopic steering control switch (only cancels steering wheel position recall).

■ Seat positions that can be memorized (→P. 171)

The adjusted positions other than the position adjusted by lumbar support switch can be recorded.

■ Operating the driving position memory after turning the engine switch off

Recorded seat positions can be activated up to 180 seconds after the driver's door is opened and another 60 seconds after it is closed again.

■ In order to correctly use the driving position memory function

If a seat position is already in the furthest possible position and the seat is operated in the same direction, the recorded position may be slightly different when it is recalled.

Memory recall function (vehicles with a smart entry & start system)

Each electronic key can be registered to recall your preferred driving position.

■ Registering procedure

Record your driving position to button “1” or “2” before performing the following:

Carry only the key to which you want to register, and then close the driver’s door. If 2 or more keys are in the vehicle, the driving position cannot be recorded properly.

- 1 Vehicles with an automatic transmission:
Check that the shift lever is in P.
Vehicles with a manual transmission:
Check that the parking brake is set.
- 2 Turn the engine switch to IGNITION ON mode.
- 3 Recall the driving position that you want to record.
- 4 While pressing the recalled button, press and hold the driver’s door lock switch (either lock or unlock) until the signal beeps.

If the button could not be registered, the buzzer sounds continuously for approximately 3 seconds.

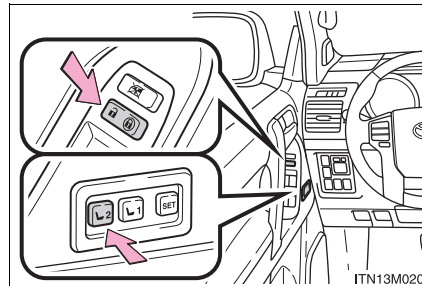

■ Recall procedure

Carry the electronic key that has been registered to the driving position, and then unlock and open the driver’s door using the smart entry & start system or wireless remote control.

The driving position will move to the recorded position.

If the driving position is in a position that has already been recorded, the seat and outside rear view mirrors will not move.

■ Cancellation procedure

Carry only the key you want to cancel and then close the driver's door.

If 2 or more keys are in the vehicle, the driving position cannot be canceled properly.

- 1 Turn the engine switch to IGNITION ON mode.
- 2 While pressing "SET" button, press and hold the driver's door lock switch (either lock or unlock) until the buzzer sounds twice.

■ Recalling the driving position using the memory recall function

- Different driving positions can be registered for each electronic key. Therefore, the driving position that is recalled may be different depending on the key being carried.
- If a door other than the driver's door is unlocked with the smart entry & start system, the driving position cannot be recalled. In this case, press the driving position button which has been set.

■ Customization

The unlock door settings of the memory recall function can be customized. (Customizable features: →P. 708)

⚠ CAUTION**■ Seat adjustment caution**

Take care during seat adjustment so that the seat does not strike the rear passenger or squeeze your body against the steering wheel.

Head restraints

Head restraints are provided for all seats.

Front, second and third manual seats (if equipped)

- ① Up
Pull the head restraints up.
- ② Down
Push the head restraint down while pushing the lock release button.

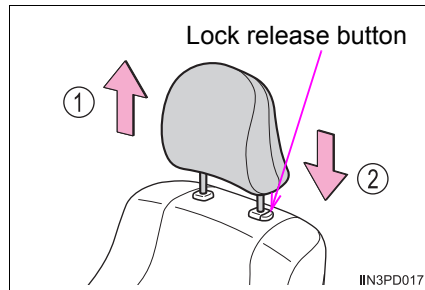

Third power seats (if equipped)

To fold the head restraints, pull the lock release strap.

To return the head restraints, lift them up until they lock.

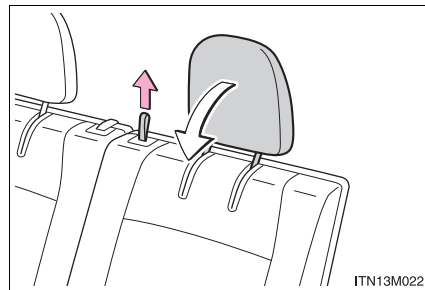

■ Removing the head restraints

- ▶ Front, second and third manual seats

Pull the head restraint up while pressing the lock release button.

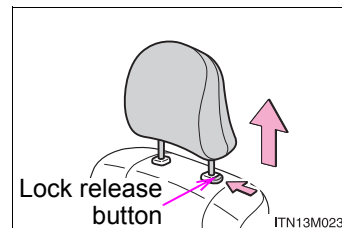

- ▶ Third power seats

The head restraint cannot be removed.

■ Installing the head restraints (front, second and third manual seats)

Align the head restraint with the installation holes and push it down to the lock position.

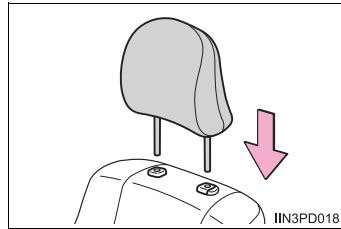
**■ Adjusting the height of the head restraints**

Make sure that the head restraints are adjusted so that the center of the head restraint is closest to the top of your ears.

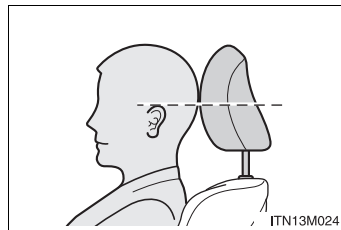
**■ Using the second center, second outer (5-door models without third seats and vehicles with longitudinal type third seats) and third manual seat head restraints**

Always raise the head restraint one level from the stowed position when using.

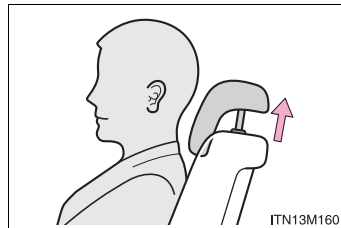
**■ Using the third power seats (if equipped)**

Always lift the head restraints up until they lock when using.

 CAUTION**■ Head restraint precautions**

Observe the following precautions regarding the head restraints. Failure to do so may result in death or serious injury.

- Use the head restraints designed for each respective seat.
- Adjust the head restraints to the correct position at all times.
- After adjusting the head restraints, push down on them and make sure they are locked in position.
- Do not drive with the head restraints removed.

Steering wheel

Adjustment procedure

► Manual adjustment type

- 1 Hold the steering wheel and pull the lever down.

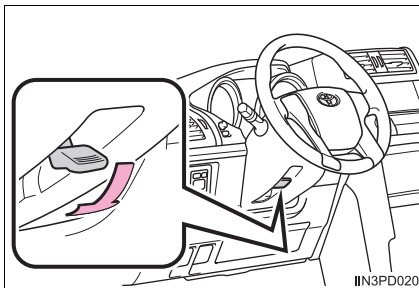

- 2 Adjust to the ideal position by moving the steering wheel horizontally and vertically.

After adjustment, pull the lever up to secure the steering wheel.

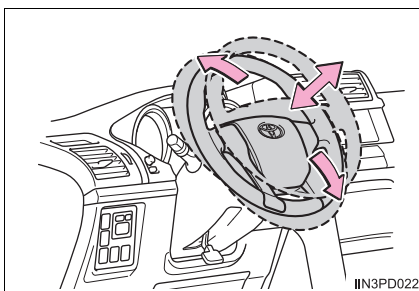

► Power adjustment type

- 1 Up
- 2 Down
- 3 Away from the driver
- 4 Toward the driver

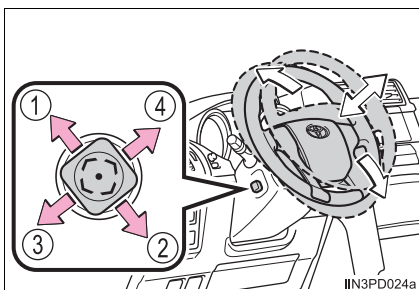

Auto tilt away (power adjustment type)

When the engine switch is turned off, the steering wheel returns to its stowed position by moving up and away to enable easier driver entry and exit.

Turning the engine switch to ACCESSORY or IGNITION ON mode will return the steering wheel to the original position.

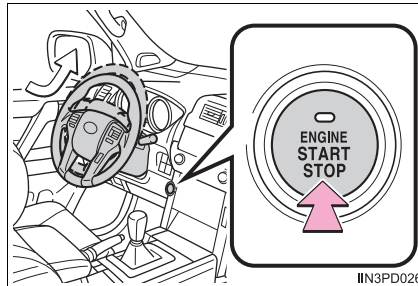

Horn

To sound the horn, press on or close to the  mark.

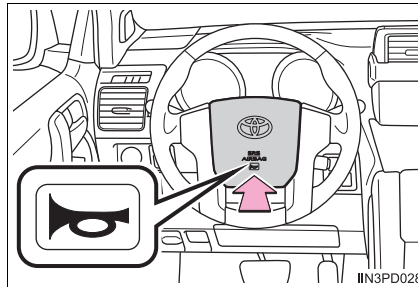

■ **The power adjustment type steering wheel can be adjusted when**

The engine switch is in ACCESSORY or IGNITION ON mode.*

*: If the driver's seat belt is fastened, the steering wheel can be adjusted regardless of engine switch mode.

■ **Automatic adjustment of the steering position**

A desired steering position can be entered to memory and recalled automatically by the driving position memory system. (→P. 189)

■ **After adjusting the steering wheel (manual adjustment type)**

Make sure that the steering wheel is securely locked.

The horn may not sound if the steering wheel is not securely locked.

 CAUTION**■ Caution while driving**

Do not adjust the steering wheel while driving. Doing so may cause the driver to mishandle the vehicle and cause an accident, resulting in death or serious injury.

■ After adjusting the steering wheel (manual adjustment type)

Make sure that the steering wheel is securely locked. Otherwise, the steering wheel may move suddenly, possibly causing an accident, and resulting in death or serious injury.

Inside rear view mirror

The rear view mirror's position can be adjusted to enable sufficient confirmation of the rear view.

Adjusting the height of rear view mirror

The height of the rear view mirror can be adjusted to suit your driving posture.

Adjust the height of the rear view mirror by moving it up and down.

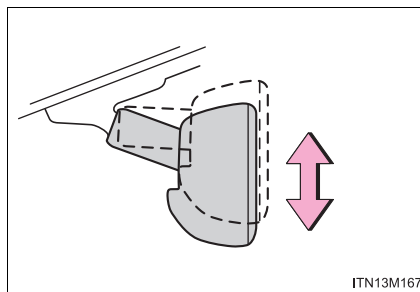

Anti-glare function

- ▶ Manual anti-glare inside rear view mirror

Reflected light from the headlights of vehicles behind can be reduced by operating the lever.

- ① Normal position
- ② Anti-glare position

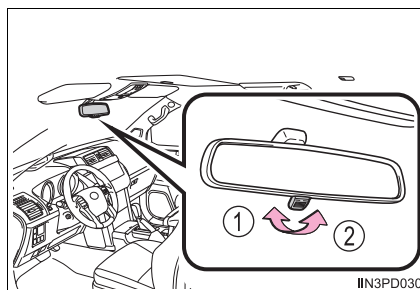

► Auto anti-glare inside rear view mirror

Responding to the level of brightness of the headlights of vehicles behind, the reflected light is automatically reduced.

Changing automatic anti-glare function mode

On/off

When the automatic anti-glare function is in ON mode, the indicator illuminates.

The function will set to ON mode each time the engine switch is turned to IGNITION ON mode.

Pressing the button turns the function to OFF mode. (The indicator also turns off.)

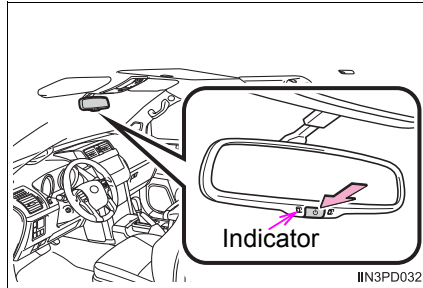

■ To prevent sensor error (vehicles with auto anti-glare inside rear view mirror)

To ensure that the sensors operate properly, do not touch or cover them.

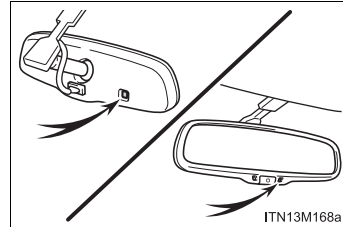

⚠ CAUTION

Do not adjust the position of the mirror while driving. Doing so may lead to mishandling of the vehicle and an accident, resulting in death or serious injury.

Outside rear view mirrors

Adjustment procedure

- 1 To select a mirror to adjust, press the switch.

- ① Left
- ② Right

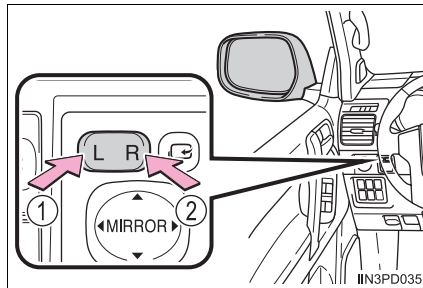

- 2 To adjust the mirror, press the switch.

- ① Up
- ② Right
- ③ Down
- ④ Left

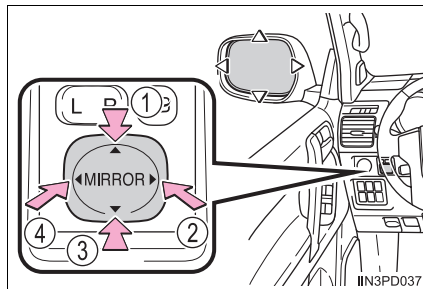

Folding the mirrors

▶ Manual type

Push the mirror back in the direction of the vehicle's rear.

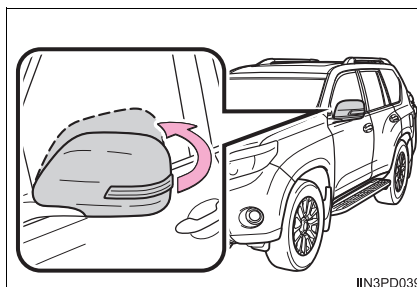

▶ Power type

Press the switch to fold the mirrors.

Press it again to extend them to the original position.

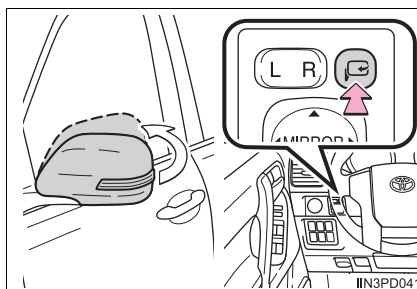

■ Mirror angle can be adjusted when

▶ Vehicles without a smart entry & start system

The engine switch is in the "ACC" or "ON" position.

▶ Vehicles with a smart entry & start system

The engine switch is in ACCESSORY or IGNITION ON mode.

■ When the mirrors are fogged up (vehicles with outside rear view mirror defoggers)

Turn on the mirror defoggers to defog the mirrors. (→P. 453, 461)

 CAUTION

■ **Important points while driving**

Observe the following precautions while driving.

Failing to do so may result in loss of control of the vehicle and cause an accident, resulting in death or serious injury.

- Do not adjust the mirrors while driving.
- Do not drive with the mirrors folded.
- Both the driver and passenger side mirrors must be extended and properly adjusted before driving.

■ **When a mirror is moving**

To avoid personal injury and mirror malfunction, be careful not to get your hand caught by the moving mirror.

■ **When the mirror defoggers are operating (vehicles with outside rear view mirror defoggers)**

Do not touch the rear view mirror surfaces, as they can become very hot and burn you.

 NOTICE

■ **If ice should jam the mirror**

Do not operate the control or scrape the mirror face. Use a spray de-icer to free the mirror.

Power windows

Opening and closing procedures

The power windows can be opened and closed using the switches.

Operating the switch moves the windows as follows:

- ① Closing
- ② One-touch closing*
- ③ Opening
- ④ One-touch opening*

*: To stop the window partway, operate the switch in the opposite direction.

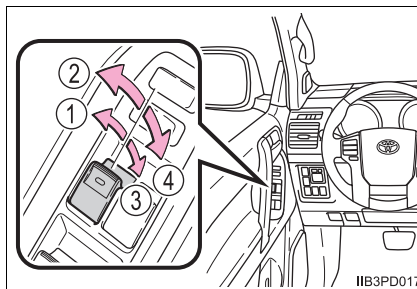

Window lock switch

Press the switch down to lock the passenger window switches.

Use this switch to prevent children from accidentally opening or closing a passenger window.

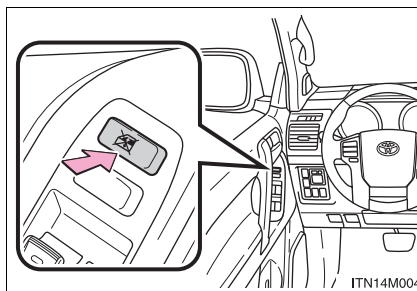

- **The power windows can be operated when**
 - ▶ Vehicles without a smart entry & start system
The engine switch is in the "ON" position.
 - ▶ Vehicles with a smart entry & start system
The engine switch is in IGNITION ON mode.

■ **Operating the power windows after turning the engine off**

▶ Vehicles without a smart entry & start system

The power windows can be operated for approximately 45 seconds even after the engine switch is turned to the “ACC” or “LOCK” position. They cannot, however, be operated once either front door is opened.

▶ Vehicles with a smart entry & start system

The power windows can be operated for approximately 45 seconds even after the engine switch is turned to ACCESSORY mode or turned off. They cannot, however, be operated once either front door is opened.

■ **Jam protection function**

If an object becomes caught between the window and the window frame, window travel is stopped and the window is opened slightly.

■ **When the power window does not close normally**

If the jam protection function is operating abnormally and a window cannot be closed, perform the following operations using the power window switch on the relevant door.

- After stopping the vehicle, the window can be closed by holding the power window switch in the one-touch closing position while the engine switch is in the “ON” position (vehicles without a smart entry & start system) or the engine switch is turned to IGNITION ON mode (vehicles with a smart entry & start system).
- If the window still cannot be closed even by carrying out the operation explained above, initialize the function by performing the following procedure.
 - 1 Press and hold the power window switch. Continue holding the switch for 1 second or more after the window has opened completely.
 - 2 Hold the power window switch in the one-touch closing position. Continue holding the switch for 1 second or more after the window has closed completely.

If you release the switch while the window is moving, start again from the beginning. If the window continues to close but then re-open slightly even after performing the above procedure correctly, have the vehicle inspected by any authorized Toyota dealer or repairer, or another duly qualified and equipped professional.

■ Door lock linked window operation

The power windows can be opened and closed using the wireless remote control or key if customized at any authorized Toyota dealer or repairer, or another duly qualified and equipped professional. (→P. 127, 131)

■ Customization

Settings (e.g. linked door lock operation) can be changed.
(Customizable features →P. 705)

⚠ CAUTION

Observe the following precautions.
Failing to do so may result in death or serious injury.

■ Closing the windows

- Check to make sure that all passengers do not have any part of their body in a position where it could be caught when a window is being operated.
- Do not allow children to operate the power windows.
Closing a power window on someone can cause serious injury, and in some instances, even death.

■ Jam protection function

- Never use any part of your body to intentionally activate the jam protection function.
- The jam protection function may not work if something gets caught just before the window fully closes.

Moon roof*

Use the overhead switches to open and close the moon roof and tilt it up and down.

Opening and closing

- ① Opens the moon roof*
The moon roof stops slightly before the fully open position to reduce wind noise.
Press the switch again to fully open the moon roof.

- ② Closes the moon roof*
*: Lightly press either end of the moon roof switch to stop the moon roof partway.

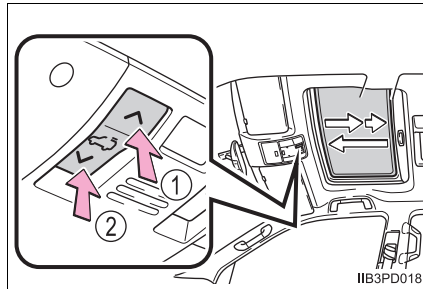

Tilting up and down

- ① Tilts the moon roof up*
- ② Tilts the moon roof down*
*: Lightly press either end of the moon roof switch to stop the moon roof partway.

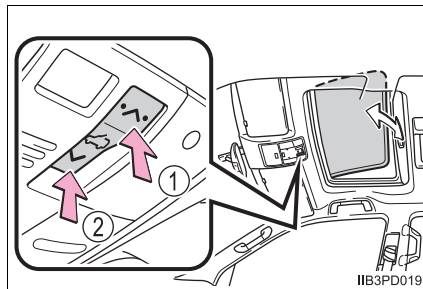

*: If equipped

- **The moon roof can be operated when**
 - ▶ Vehicles without a smart entry & start system
The engine switch is in the “ON” position.
 - ▶ Vehicles with a smart entry & start system
The engine switch is in IGNITION ON mode.
- **Operating the moon roof after turning the engine off**
 - ▶ Vehicles without a smart entry & start system
The moon roof can be operated for approximately 45 seconds after the engine switch is turned to the “ACC” or “LOCK” position. It cannot, however, be operated once either front door is opened.
 - ▶ Vehicles with a smart entry & start system
The moon roof can be operated for approximately 45 seconds after the engine switch is turned to ACCESSORY mode or turned off. It cannot, however, be operated once either front door is opened.
- **Jam protection function**

If an object is detected between the moon roof and the frame while the moon roof is closing or tilting down, travel is stopped and the moon roof opens slightly.
- **Sunshade**

The sunshade can be opened and closed manually. However, the sunshade will open automatically when the moon roof is opened.
- **Door lock linked moon roof operation**

The moon roof can be opened and closed using the wireless remote control or key if customized at any authorized Toyota dealer or repairer, or another duly qualified and equipped professional. (→P. 127, 131)
- **Moon roof open reminder function**

An alarm will sound when the driver’s door is opened with the moon roof not fully closed and the engine switch off.

■ When the moon roof does not close normally

Perform the following procedure:

- If the moon roof closes but then re-opens slightly

1 Stop the vehicle.

2 Press and hold “∨” on the . *1



The moon roof will close, re-open and pause for approximately 10 seconds. *2 Then it will close again, tilt up and pause for approximately 1 second. Finally, it will tilt down, open and close.

3 Check to make sure that the moon roof is completely closed and then release the switch.

- If the moon roof tilts down but then tilts back up

1 Stop the vehicle.

2 Press and hold “∧” on the . *1 until the moon roof moves into the tilt up position and stops.



- 3 Release “^” on the  once and then press and hold “^” on the  again.*1

The moon roof will pause for approximately 10 seconds in the tilt up position.*2 Then it will adjust slightly and pause for approximately 1 second. Finally, it will tilt down, open and close.

- 4 Check to make sure that the moon roof is completely closed and then release the switch.

*1: If the switch is released at the incorrect time, the procedure will have to be performed again from the beginning.

*2: If the switch is released after the above mentioned 10 second pause, automatic operation will be disabled. In that case, press and hold “v” on

the  or “^” on the  and the moon roof will tilt up and pause for approximately 1 second. Then it will tilt down, open and close. Check to make sure that the moon roof is completely closed and then release the switch.

If the moon roof does not fully close even after performing the above procedure correctly, have the vehicle inspected by any authorized Toyota dealer or repairer, or another duly qualified and equipped professional.

■ Customization

Settings (e.g. linked door lock operation) can be changed.
(Customizable features →P. 705)

 **CAUTION**

Observe the following precautions.
Failing to do so may cause death or serious injury.

■ Opening the moon roof

- Do not allow any passengers to put their hands or heads outside the vehicle while it is moving.
- Do not sit on top of the moon roof.

■ Closing the moon roof

- Check to make sure that all passengers do not have any part of their bodies in a position where it could be caught when the moon roof is being operated.
- Do not allow children to operate the moon roof.
Closing the moon roof on someone can cause death or serious injury.

■ Jam protection function

- Never use any part of your body to intentionally activate the jam protection function.
- The jam protection function may not work if something gets caught just before the moon roof fully closes.

Driving

4

4-1. Before driving		4-4. Refueling	
Driving the vehicle	212	Opening the fuel tank cap	288
Cargo and luggage	224	4-5. Using the driving support systems	
Trailer towing	227	Cruise control.....	292
4-2. Driving procedures		Dynamic radar cruise control.....	296
Engine (ignition) switch (vehicles without a smart entry & start system).....	240	Toyota parking assist-sensor	312
Engine (ignition) switch (vehicles with a smart entry & start system).....	243	Rear view monitor system	322
Automatic transmission	251	Toyota parking assist monitor.....	333
Manual transmission.....	258	Driving assist systems	360
Turn signal lever	263	BSM (Blind Spot Monitor).....	366
Parking brake	264	• The Blind Spot Monitor function	373
Diesel Particulate Filter system (diesel engine only)	265	• The Rear Crossing Traffic Alert function	375
4-3. Operating the lights and wipers		PCS (Pre-Crash Safety system).....	378
Headlight switch	267	4-6. Driving tips	
Fog light switch.....	277	Winter driving tips	387
Windshield wipers and washer.....	279		
Rear window wiper and washer	285		
Headlight cleaner switch.....	286		

Driving the vehicle

The following procedures should be observed to ensure safe driving:

Starting the engine

→P. 240, 243

Driving

▶ Automatic transmission

- 1 With the brake pedal depressed, shift the shift lever to D. (→P. 251)
- 2 Release the parking brake. (→P. 264)
- 3 Gradually release the brake pedal and gently depress the accelerator pedal to accelerate the vehicle.

▶ Manual transmission

- 1 While depressing the clutch pedal, shift the shift lever to 1. (→P. 258)
- 2 Release the parking brake. (→P. 264)
- 3 Gradually release the clutch pedal. At the same time, gently depress the accelerator pedal to accelerate the vehicle.

Stopping

▶ Automatic transmission

- 1 With the shift lever in D, depress the brake pedal.
- 2 If necessary, set the parking brake.

If the vehicle is to be stopped for an extended period of time, shift the shift lever to P or N. (→P. 251)

▶ Manual transmission

- 1 While depressing the clutch pedal, depress the brake pedal.
- 2 If necessary, set the parking brake.

If the vehicle is to be stopped for an extended period of time, shift the shift lever to N. (→P. 258)

Parking the vehicle

▶ Automatic transmission

- 1 With the shift lever in D, depress the brake pedal.
- 2 Shift the shift lever to P. (→P. 251)
- 3 Set the parking brake. (→P. 264)
- 4 Vehicles without a smart entry & start system:
Turn the engine switch to the “LOCK” position to stop the engine.
Vehicles with a smart entry & start system:
Press the engine switch to stop the engine.
- 5 Lock the door, making sure that you have the key on your person.
If parking on a hill, block the wheels as needed.

▶ Manual transmission

- 1 While depressing the clutch pedal, depress the brake pedal.
- 2 Shift the shift lever to N. (→P. 258)
- 3 Set the parking brake. (→P. 264)
If parking on a hill, shift the shift lever to 1 or R as needed.
- 4 Vehicles without a smart entry & start system:
Turn the engine switch to the “LOCK” position to stop the engine.
Vehicles with a smart entry & start system:
Press the engine switch to stop the engine.
- 5 Lock the door, making sure that you have the key on your person.
If parking on a hill, block the wheels as needed.

Starting off on a steep uphill

▶ Automatic transmission

- 1 Make sure that the parking brake is set and shift the shift lever to D.
- 2 Gently depress the accelerator pedal.
- 3 Release the parking brake.

▶ Manual transmission

- 1 With the parking brake firmly set and the clutch pedal fully depressed, shift the shift lever to 1.
- 2 Lightly depress the accelerator pedal at the same time as gradually releasing the clutch pedal.
- 3 Release the parking brake.

■ When starting off on a uphill (vehicles with hill-start assist control system)

The hill-start assist control is available. (→Refer to the “Off-road Driving Owner’s Manual”)

■ Driving in the rain

- Drive carefully when it is raining, because visibility will be reduced, the windows may become fogged-up, and the road will be slippery.
- Drive carefully when it starts to rain, because the road surface will be especially slippery.
- Refrain from high speeds when driving on an expressway in the rain, because there may be a layer of water between the tires and the road surface, preventing the steering and brakes from operating properly.

■ Engine speed while driving (automatic transmission)

In the following conditions, the engine speed may become high while driving. This is due to automatic up-shifting control or down-shifting implementation to meet driving conditions. It does not indicate sudden acceleration.

- The vehicle is judged to be driving uphill or downhill
- When the accelerator pedal is released

■ Breaking in your new Toyota

To extend the life of the vehicle, observing the following precautions is recommended:

- For the first 300 km (200 miles):
Avoid sudden stops.
- For the first 800 km (500 miles):
Do not tow a trailer.
- For the first 1000 km (600 miles):
 - Do not drive at extremely high speeds.
 - Avoid sudden acceleration.
 - Do not drive continuously in the low gears.
 - Do not drive at a constant speed for extended periods.
 - Do not drive slowly with the manual transmission in a high gear.

■ Drum-in-disc type parking brake system

Your vehicle has a drum-in-disc type parking brake system.

This type of brake system needs bedding-down of the brake shoes periodically or whenever the parking brake shoes and/or drum are replaced.

Have any authorized Toyota dealer or repairer, or another duly qualified and equipped professional perform the bedding-down operation.

■ Idling time before stopping the engine (diesel engine)

To prevent damage to the turbocharger, allow the engine to idle immediately after high-speed driving or driving up a hill.

Driving condition		Idling time
Normal city driving		Not necessary
High-speed driving	Constant speed of approx. 80 km/h (50 mph)	Approximately 20 seconds
	Constant speed of approx. 100 km/h (63 mph)	Approximately 1 minute
Steep hill driving or continuous driving at 100 km/h (63 mph) or more (race track driving etc.)		Approximately 2 minutes

■ Operating your vehicle in a foreign country

Comply with the relevant vehicle registration laws and confirm the availability of the correct fuel. (→P. 682)

 CAUTION

Observe the following precautions.
Failure to do so may result in death or serious injury.

■ **When starting the vehicle**

On vehicles with an automatic transmission, always keep your foot on the brake pedal while stopped with the engine running. This prevents the vehicle from creeping.

■ **When driving the vehicle**

- Do not drive if you are unfamiliar with the location of the brake and accelerator pedals to avoid depressing the wrong pedal.
 - Accidentally depressing the accelerator pedal instead of the brake pedal will result in sudden acceleration that may lead to an accident.
 - When backing up, you may twist your body around, leading to a difficulty in operating the pedals. Make sure to operate the pedals properly.
 - Make sure to keep a correct driving posture even when moving the vehicle only slightly. This allows you to depress the brake and accelerator pedals properly.
 - Depress the brake pedal using your right foot. Depressing the brake pedal using your left foot may delay response in an emergency, resulting in an accident.
- Do not drive the vehicle over or stop the vehicle near flammable materials. The exhaust system and exhaust gases can be extremely hot. These hot parts may cause a fire if there is any flammable material nearby.

 CAUTION

Observe the following precautions.
Failure to do so may result in death or serious injury.

■ When driving the vehicle

- During normal driving, do not turn off the engine. Turning the engine off while driving will not cause loss of steering or braking control, but the power assist to these systems will be lost. This will make it more difficult to steer and brake, so you should pull over and stop the vehicle as soon as it is safe to do so.
However, in the event of an emergency, such as if it becomes impossible to stop the vehicle in the normal way: →P. 585
- Use engine braking (downshift) to maintain a safe speed when driving down a steep hill.
Using the brakes continuously may cause the brakes to overheat and lose effectiveness. (→P. 253)
- Do not adjust the positions of the steering wheel, the seat, or the inside or outside rear view mirrors while driving.
Doing so may result in a loss of vehicle control.
- Always check that all passengers' arms, heads or other parts of their body are not outside the vehicle.

 CAUTION

Observe the following precautions.
Failure to do so may result in death or serious injury.

■ **When driving on slippery road surfaces**

- Sudden braking, acceleration and steering may cause tire slippage and reduce your ability to control the vehicle.
- Sudden acceleration, engine braking due to shift changing, or changes in engine speed could cause the vehicle to skid.
- After driving through a puddle, lightly depress the brake pedal to make sure that the brakes are functioning properly. Wet brake pads may prevent the brakes from functioning properly. If the brakes on only one side are wet and not functioning properly, steering control may be affected.

■ **When shifting the shift lever**

- On vehicles with an automatic transmission, do not let the vehicle roll backwards while the shift lever is in a driving position, or roll forward while the shift lever is in R.
Doing so may cause the engine to stall or lead to poor brake and steering performance, resulting in an accident or damage to the vehicle.
- On vehicles with an automatic transmission, do not shift the shift lever to P while the vehicle is moving.
Doing so can damage the transmission and may result in a loss of vehicle control.
- Do not shift the shift lever to R while the vehicle is moving forward.
Doing so can damage the transmission and may result in a loss of vehicle control.
- Do not shift the shift lever to D (vehicles with an automatic transmission) or 1 (vehicles with a manual transmission) while the vehicle is moving backward.
Doing so can damage the transmission and may result in a loss of vehicle control.
- Moving the shift lever to N while the vehicle is moving will disengage the engine from the transmission.
Engine braking is not available when N is selected.
- On vehicles with an automatic transmission, be careful not to shift the shift lever with the accelerator pedal depressed. Shifting the shift lever to a gear other than P or N may lead to unexpected rapid acceleration of the vehicle that may cause an accident and result in death or serious injury.

 CAUTION

Observe the following precautions.
Failure to do so may result in death or serious injury.

■ **If you hear a squealing or scraping noise (brake pad wear indicators)**

Have the brake pads checked and replaced by any authorized Toyota dealer or repairer, or another duly qualified and equipped professional as soon as possible.

Rotor damage may result if the pads are not replaced when needed.

It is dangerous to drive the vehicle when the wear limits of the brake pads and/or those of the brake discs are exceeded.

■ **When the vehicle is stopped**

- Do not race the engine.

If the vehicle is in any gear other than P (vehicles with an automatic transmission only) or N, the vehicle may accelerate suddenly and unexpectedly, causing an accident.

- On vehicles with automatic transmission, in order to prevent accidents due to the vehicle rolling away, always keep depressing the brake pedal while the engine is running, and apply the parking brake as necessary.

- If the vehicle is stopped on an incline, in order to prevent accidents caused by the vehicle rolling forward or backward, always depress the brake pedal and securely apply the parking brake as needed.

- Avoid revving or racing the engine.

Running the engine at high speed while the vehicle is stopped may cause the exhaust system to overheat, which could result in a fire if combustible material is nearby.

 CAUTION

Observe the following precautions.
Failure to do so may result in death or serious injury.

■ When the vehicle is parked

- Do not leave glasses, cigarette lighters, spray cans, or soft drink cans in the vehicle when it is in the sun.
Doing so may result in the following:
 - Gas may leak from a cigarette lighter or spray can, and may lead to a fire.
 - The temperature inside the vehicle may cause the plastic lenses and plastic material of glasses to deform or crack.
 - Soft drink cans may fracture, causing the contents to spray over the interior of the vehicle, and may also cause a short circuit in the vehicle's electrical components.
- Do not leave cigarette lighters in the vehicle. If a cigarette lighter is in a place such as the glove box or on the floor, it may be lit accidentally when luggage is loaded or the seat is adjusted, causing a fire.
- Do not attach adhesive discs to the windshield or windows. Do not place containers such as air fresheners on the instrument panel or dashboard. Adhesive discs or containers may act as lenses, causing a fire in the vehicle.
- Do not leave a door or window open if the curved glass is coated with a metallized film such as a silver-colored one. Reflected sunlight may cause the glass to act as a lens, causing a fire.
- Always apply the parking brake, shift the shift lever to P (vehicles with an automatic transmission only), stop the engine and lock the vehicle.
Do not leave the vehicle unattended while the engine is running.
- Do not touch the exhaust pipes while the engine is running or immediately after turning the engine off.
Doing so may cause burns.

 CAUTION

Observe the following precautions.
Failure to do so may result in death or serious injury.

■ **When taking a nap in the vehicle**

Always turn the engine off. Otherwise, if you accidentally move the shift lever or depress the accelerator pedal, this could cause an accident or fire due to engine overheating. Additionally, if the vehicle is parked in a poorly ventilated area, exhaust gases may collect and enter the vehicle, leading to death or a serious health hazard.

■ **When braking**

- When the brakes are wet, drive more cautiously.
Braking distance increases when the brakes are wet, and this may cause one side of the vehicle to brake differently than the other side. Also, the parking brake may not securely hold the vehicle.
- If the power brake assist function does not operate, do not follow other vehicles closely and avoid hills or sharp turns that require braking. In this case, braking is still possible, but the brake pedal should be depressed more firmly than usual. Also, the braking distance will increase. Have your brakes fixed immediately.
- Do not pump the brake pedal if the engine stalls.
Each push on the brake pedal uses up the reserve for the power-assisted brakes.
- The brake system consists of 2 individual hydraulic systems: If one of the systems fails, the other will still operate. In this case, the brake pedal should be depressed more firmly than usual and the braking distance will increase.
Have your brakes fixed immediately.

■ **If the vehicle becomes stuck**

Do not spin the wheels excessively when any of the tires is up in the air, or the vehicle is stuck in sand, mud, etc. This may damage the driveline components or propel the vehicle forward or backward, causing an accident.



NOTICE

■ When driving the vehicle

▶ Automatic transmission

- Do not depress the accelerator and brake pedals at the same time during driving, as this may restrain driving torque.
- Do not use the accelerator pedal or depress the accelerator and brake pedals at the same time to hold the vehicle on a hill.

▶ Manual transmission

- Do not depress the accelerator and brake pedals at the same time during driving, as this may restrain driving torque.
- Do not shift gears unless the clutch pedal is fully depressed. After shifting, do not release the clutch abruptly. Doing so may damage the clutch, transmission and gears.
- Observe the following to prevent the clutch from being damaged.
 - Do not rest your foot on the clutch pedal while driving.
Doing so may cause clutch trouble.
 - Do not use any gear other than the 1st gear when starting off and moving forward.
Doing so may damage the clutch.
 - Do not use the clutch to hold the vehicle when stopping on an uphill grade.
Doing so may damage the clutch.
- Do not shift the shift lever to R when the vehicle is still moving. Doing so may damage the clutch, transmission and gears.

 NOTICE

■ **When parking the vehicle (vehicles with an automatic transmission)**

Always shift the shift lever to P. Failure to do so may cause the vehicle to move or the vehicle may accelerate suddenly if the accelerator pedal is accidentally depressed.

■ **Avoiding damage to vehicle parts**

- Do not turn the steering wheel fully in either direction and hold it there for an extended period of time.
Doing so may damage the power steering pump.
- When driving over bumps in the road, drive as slowly as possible to avoid damaging the wheels, underside of the vehicle, etc.
- Diesel engine only: Make sure to idle the engine immediately after high-speed driving or hill climbing. Stop the engine only after the turbocharger has cooled down.
Failure to do so may cause damage to the turbocharger.

■ **If you get a flat tire while driving**

A flat or damaged tire may cause the following situations. Hold the steering wheel firmly and gradually depress the brake pedal to slow down the vehicle.

- It may be difficult to control your vehicle.
- The vehicle will make abnormal sounds or vibrations.
- The vehicle will lean abnormally.

Information on what to do in case of a flat tire. (→P. 622)

■ **When encountering flooded roads**

Do not drive on a road that has flooded after heavy rain etc. Doing so may cause the following serious damage to the vehicle:

- Engine stalling
- Short in electrical components
- Engine damage caused by water immersion

In the event that you drive on a flooded road and the vehicle is flooded, be sure to have any authorized Toyota dealer or repairer, or another duly qualified and equipped professional check the following:

- Brake function
- Changes in quantity and quality of oil and fluid used for the engine, transmission, transfer, differentials, etc.
- Lubricant condition for the propeller shaft, bearings and suspension joints (where possible), and the function of all joints, bearings, etc.

Cargo and luggage

Take notice of the following information about storage precautions, cargo capacity and load:

Roof luggage carrier (if equipped)

■ Roof luggage carrier components

- ① Roof rail
- ② Cross rail

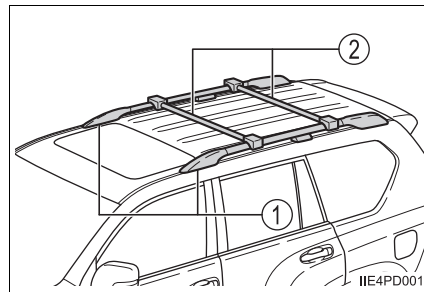

⚠ CAUTION

■ Things that must not be carried in the luggage compartment

The following things may cause a fire if loaded in the luggage compartment:

- Receptacles containing gasoline
- Aerosol cans

 CAUTION**■ Storage precautions**

Observe the following precautions.

Failure to do so may prevent the pedals from being depressed properly, may block the driver's vision, or may result in items hitting the driver or passengers, possibly causing an accident.

- Stow cargo and luggage in the luggage compartment whenever possible.
- Do not stack anything in the luggage compartment higher than the seat-backs.
- Do not place cargo or luggage in or on the following locations.
 - At the feet of the driver
 - On the front passenger or rear seats (when stacking items)
 - On the luggage cover (if equipped)
 - On the instrument panel
 - On the dashboard
- Secure all items in the occupant compartment.
- When you fold down the rear seats, long items should not be placed directly behind the front seats.
- Never allow anyone to ride in the luggage compartment. It is not designed for passengers. They should ride in their seats with their seat belts properly fastened. Otherwise, they are much more likely to suffer death or serious bodily injury, in the event of sudden braking, sudden swerving or an accident.

■ Load and distribution

- Do not overload your vehicle.
- Do not apply loads unevenly.
Improper loading may cause deterioration of steering or braking control which may cause death or serious injury.

 CAUTION**■ Roof luggage carrier precautions (if equipped)**

To use the roof rails as a roof luggage carrier, you must fit the roof rails with two or more genuine Toyota cross rails or their equivalent. Follow the manufacturer's instructions and precautions when installing the cross rails or their equivalent.

When you load cargo on the roof luggage carrier, observe the following:

- Place the cargo so that its weight is distributed evenly between the front and rear axles.
- If loading long or wide cargo, never exceed the vehicle overall length or width. (→P. 676)
- Before driving, make sure the cargo is securely fastened on the roof luggage carrier.
- Loading cargo on the roof luggage carrier will make the center of gravity of the vehicle higher. Avoid high speeds, sudden starts, sharp turns, sudden braking or abrupt maneuvers, otherwise it may result in loss of control or vehicle rollover due to failure to operate this vehicle correctly and result in death or serious injury.
- If driving for a long distance, on rough roads, or at high speeds, stop the vehicle now and then during the trip to make sure the cargo remains in its place.
- Do not exceed 80 kg (176 lb.) cargo weight on the roof luggage carrier.

 NOTICE**■ When loading cargo on the roof luggage carrier (if equipped)**

Be careful not to scratch the surface of the moon roof (if equipped).

Trailer towing

Your vehicle is designed primarily as a passenger-and-load-carrying vehicle. Towing a trailer will have an adverse effect on handling, performance, braking, durability, and fuel consumption. Your safety and satisfaction depend on the proper use of correct equipment and cautious driving habits. For your safety and the safety of others, do not overload the vehicle or trailer.

To tow a trailer safely, use extreme care and drive the vehicle in accordance with the trailer's characteristics and operating conditions.

Toyota warranties do not apply to damage or malfunction caused by towing a trailer for commercial purposes.

Ask your local authorized Toyota dealer or repairer, or another duly qualified and equipped professional for further details before towing, as there are additional legal requirements in some countries.

◆ Weight limits

Check the allowable towing capacity, GVM (Gross Vehicle Mass), MPAC (Maximum Permissible Axle Capacity), and permissible draw bar load before towing. (→P. 676)

◆ Towing hitch/bracket

Toyota recommends the use of the Toyota hitch/bracket for your vehicle. Other products of a suitable nature and comparable quality may also be used.

◆ To prevent an accident

The handling of the vehicle will feel different when towing a trailer. Beware of the 3 most common causes of towing-related accidents: driver error, excessive speed, and overloading.

Selecting a trailer ball

Use the correct trailer ball for your application.

- ① Trailer ball load rating
Matches or exceeds the gross trailer weight rating of the trailer.
- ② Ball diameter
Matches the size of the trailer coupler. Most couplers are stamped with the required trailer ball size.
- ③ Shank length
Protrudes beyond the bottom of the lock washer and nut at least 2 threads.
- ④ Shank diameter
Matches the ball mount hole diameter size.

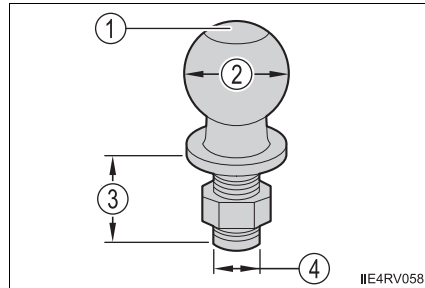

Connecting trailer lights

Use the wire harness stored in the rear end.

Important points regarding trailer loads

■ Total trailer weight and permissible drawbar load

① Total trailer weight

Weight of the trailer itself plus the trailer load should be within the maximum towing capacity. Exceeding this weight is dangerous. (→P. 676)

When towing a trailer, use a friction coupler or friction stabilizer (sway control device).

When the total trailer weight is over 2000 kg (4409 lb.), a friction stabilizer (sway control device) is required.

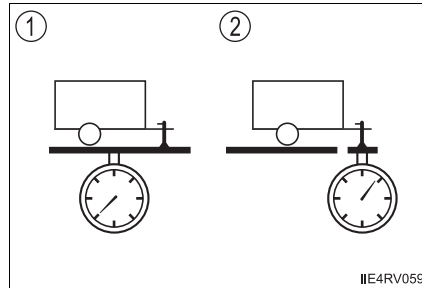

② Permissible drawbar load

Allocate the trailer load so that the drawbar load is greater than 25 kg (55.1 lb.) or 4 % of the towing capacity. Do not let the drawbar load exceed the indicated weight. (→P. 676)

■ Information tag (manufacturer's label)

① Gross vehicle mass

Vehicle category M1 models*:

The combined weight of the driver, passengers, luggage, towing hitch, total curb mass and drawbar load should not exceed the gross vehicle mass by more than 100 kg (220.5 lb.). Exceeding this weight is dangerous.

Vehicle category N1 models*:

The combined weight of the driver, passengers, cargo, towing hitch, total curb mass and drawbar load must not exceed the gross vehicle mass. Exceeding this weight is dangerous.

② Maximum permissible rear axle capacity

Vehicle category M1 models*:

The weight borne by the rear axle should not exceed the maximum permissible axle capacity by 15 % or more. Exceeding this weight is dangerous.

Vehicle category N1 models*:

The weight borne by the rear axle should not exceed the maximum permissible axle capacity. Exceeding this weight is dangerous.

The values for towing capacity were derived from testing conducted at sea level. Take note that engine output and towing capacity will be reduced at high altitudes.

*: To distinguish the vehicle category, ask any authorized Toyota dealer or repairer, or another duly qualified and equipped professional.

► Type A

► Type B

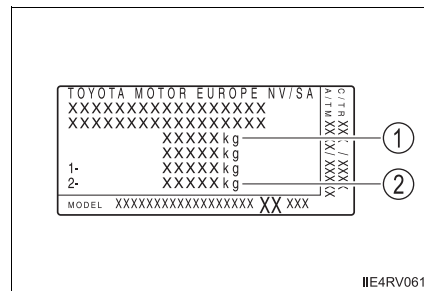
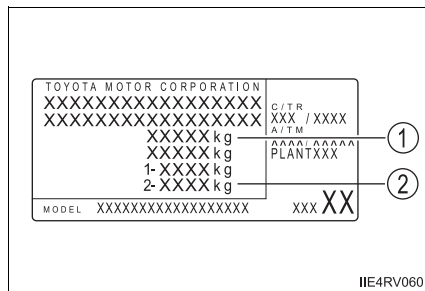

 CAUTION**■ Vehicle category M1 models*: When the gross vehicle mass limit or maximum permissible axle capacity is exceeded**

Do not exceed the established speed limit for towing a trailer in built-up areas or 100 km/h (62 mph), whichever is lower.

Failing to observe this precaution may lead to an accident causing death or serious injury.

*: To distinguish the vehicle category, ask any authorized Toyota dealer or repairer, or another duly qualified and equipped professional.

Installation positions for the towing hitch/bracket and hitch ball

► 5-door models

- ① 78 mm (3.0 in.)
- ② 78 mm (3.0 in.)
- ③ 53 mm (2.1 in.)
- ④ 53 mm (2.1 in.)
- ⑤ 53 mm (2.1 in.)
- ⑥ 53 mm (2.1 in.)
- ⑦ 1219 mm (48.0 in.)
- ⑧ 137 mm (5.4 in.)^{*1}
141 mm (5.6 in.)^{*2}
- ⑨ 79 mm (3.1 in.)^{*1}
83 mm (3.3 in.)^{*2}
- ⑩ 54 mm (2.1 in.)^{*1}
58 mm (2.3 in.)^{*2}
- ⑪ 428 mm (16.9 in.)^{*1}
336 mm (13.2 in.)^{*2}
- ⑫ 200 mm (7.9 in.)^{*1}
199 mm (7.8 in.)^{*2}
- ⑬ 171 mm (6.7 in.)^{*1}
169 mm (6.7 in.)^{*2}
- ⑭ 171 mm (6.7 in.)^{*1}
168 mm (6.6 in.)^{*2}

*1: Vehicles with rear height control air suspension

*2: Vehicles without rear height control air suspension

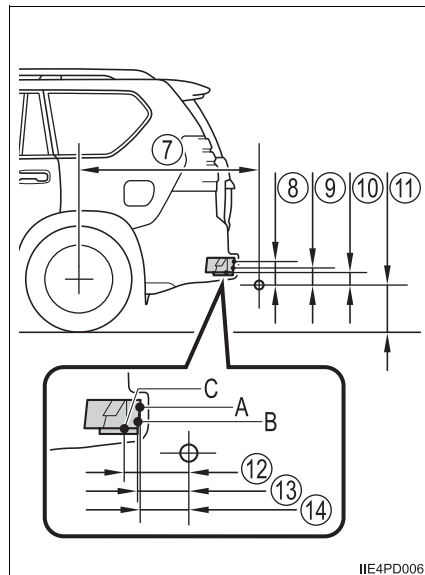
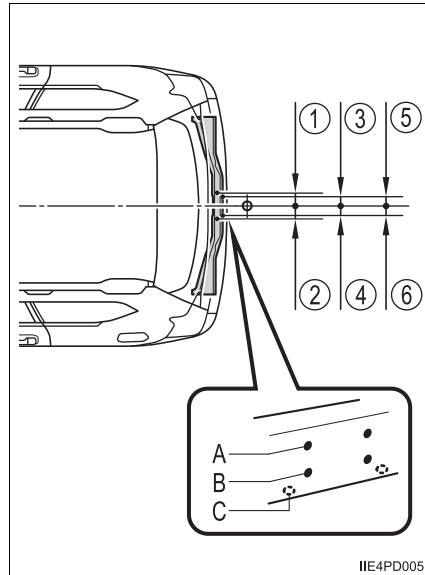

► 3-door models

- ① 78 mm (3.0 in.)
- ② 78 mm (3.0 in.)
- ③ 53 mm (2.1 in.)
- ④ 53 mm (2.1 in.)
- ⑤ 53 mm (2.1 in.)
- ⑥ 53 mm (2.1 in.)
- ⑦ 1110 mm (43.7 in.)
- ⑧ 142 mm (5.6 in.)
- ⑨ 84 mm (3.3 in.)
- ⑩ 59 mm (2.3 in.)
- ⑪ 327 mm (12.9 in.)
- ⑫ 199 mm (7.8 in.)
- ⑬ 169 mm (6.7 in.)
- ⑭ 167 mm (6.6 in.)

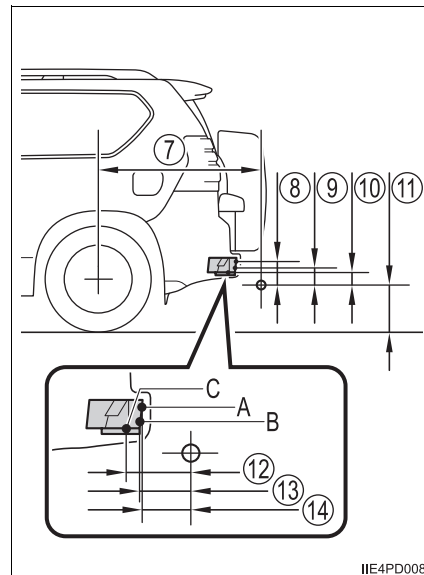
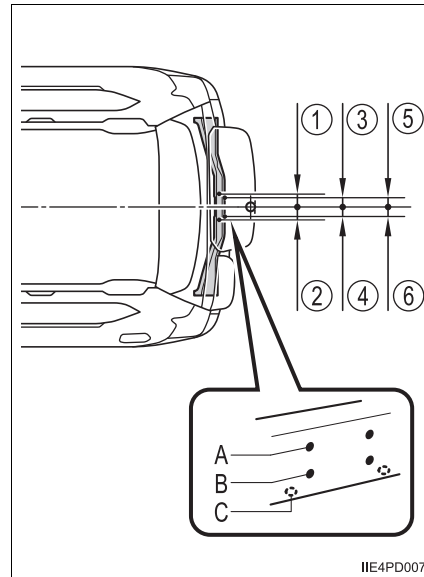

■ When connecting and disconnecting a trailer (vehicles with rear height control air suspension)

● Connecting

- 1 Set the rear height control air suspension to LO mode.
- 2 Turn off the engine switch or the rear height control air suspension.
- 3 Connect the trailer.
- 4 Turn on the switch that was turned off on step 2.
- 5 Set the rear height control air suspension to N mode.

● Disconnecting

- 1 Set the rear height control air suspension to LO mode.
- 2 Turn off the rear height control air suspension.
- 3 Turn off the engine switch.
- 4 Set the supporting leg of a trailer on the ground and raise the hitch by 100 mm (4 in.).
- 5 Turn on the engine switch.
- 6 Turn on the rear height control air suspension.
- 7 Wait until vehicle height is stabilized.

Make sure the hitch is disconnected. If the hitch does not disconnect, raise the hitch higher and repeat steps 2 through 7.

■ Tire information

- On some models, increase the tire inflation pressure to 20.0 kPa (0.2 kgf/cm² or bar, 3 psi) greater than the recommended value when towing. (→P. 699)
- Increase the air pressure of the trailer tires in accordance with the total trailer weight and according to the values recommended by the manufacturer of your trailer.

■ Trailer lights

Check that the turn signal lights and stoplights are operating correctly every time you hitch up the trailer. Directly wiring up to your vehicle may damage the electrical system and stop the lights from functioning correctly.

■ Break-in schedule

Toyota recommends that vehicles fitted with new power train components should not be used for towing trailers for the first 800 km (500 miles).

■ Safety checks before towing

- Check that the maximum load limit for the towing hitch/bracket hitch ball is not exceeded. Bear in mind that the coupling weight of the trailer will add to the load exerted on the vehicle. Also make sure that the total load exerted on the vehicle is within the range of the weight limits. (→P. 230)
- Ensure that the trailer load is secure.
- Supplementary outside rear view mirrors should be added to the vehicle if the traffic behind cannot be clearly seen with standard mirrors. Adjust the extending arms of these mirrors on both sides of the vehicle so that they always provide maximum visibility of the road behind.

■ Maintenance

- Maintenance must be performed more frequently when using the vehicle for towing due to the greater weight burden placed on the vehicle compared to normal driving.
- Retighten all bolts securing the hitching ball and bracket after towing for approximately 1000 km (600 miles).

■ If trailer sway occurs

One or more factors (crosswinds, passing vehicles, rough roads, etc.) can adversely affect handling of your vehicle and trailer, causing instability.

- If trailer swaying occurs:
 - Firmly grip the steering wheel. Steer straight ahead.
Do not try to control trailer swaying by turning the steering wheel.
 - Begin releasing the accelerator pedal immediately but very gradually to reduce speed.
Do not increase speed. Do not apply vehicle brakes.If you make no extreme correction with the steering or brakes, your vehicle and trailer should stabilize (if enabled, Trailer Sway Control can also help to stabilize the vehicle and trailer.).
- After the trailer swaying has stopped:
 - Stop in a safe place. Get all occupants out of the vehicle.
 - Check the tires of the vehicle and the trailer.
 - Check the load in the trailer.
Make sure the load has not shifted.
Make sure the tongue weight is appropriate, if possible.
 - Check the load in the vehicle.
Make sure the vehicle is not overloaded after occupants get in.If you cannot find any problems, the speed at which trailer swaying occurred is beyond the limit of your particular vehicle-trailer combination. Drive at a lower speed to prevent instability. Remember that swaying of the towing vehicle-trailer increases as speed increases.

 CAUTION**■ To avoid accident or injury**

- Vehicles with the rear height control air suspension:
Set the vehicle height to the low mode and turn off the rear height control air suspension to prevent the vehicle height from automatically changing.
- Vehicles with the emergency tire puncture repair kit:
Do not tow a trailer when the tire installed is repaired with the emergency tire puncture repair kit.

 NOTICE**■ When the rear bumper strengthening material is aluminum**

Ensure the steel bracket part does not come directly in contact with that area.

When steel and aluminum come into contact, there is a reaction similar to corrosion, which will weaken the section concerned and may result in damage. Apply a rust inhibitor to parts that will come in contact when attaching a steel bracket.

Guidance

Your vehicle will handle differently when towing a trailer. In order to avoid accident, death or serious injury, keep the following in mind when towing:

■ **Checking connections between trailer and lights**

Stop the vehicle and check the operation of the connection between the trailer and lights after driving for a brief period as well as before starting off.

■ **Practicing driving with a coupled trailer**

- Get the feel for turning, stopping and reversing with the trailer coupled by practicing in an area with no or light traffic.
- When reversing with a coupled trailer, hold the section of the steering wheel nearest to you and rotate clockwise to turn the trailer left or counterclockwise to turn it right. Always rotate a little at a time to prevent steering error. Have someone guide you when reversing to lessen the risk of accident.

■ **Increasing vehicle-to-vehicle distance**

At a speed of 10 km/h (6 mph), the distance to the vehicle running ahead of you should be equivalent to or greater than the combined length of your vehicle and trailer. Avoid sudden braking that may cause skidding. Otherwise, the vehicle may spin out of control. This is especially true when driving on wet or slippery road surfaces.

■ **Sudden acceleration/steering input/cornering**

Executing sharp turns when towing may result in the trailer colliding with your vehicle. Decelerate well in advance when approaching turns and take them slowly and carefully to avoid sudden braking.

■ **Important points regarding turning**

The wheels of the trailer will travel closer to the inside of the curve than the wheels of the vehicle. To make allowance for this, take the turns wider than you would normally do.

■ Important points regarding stability

Vehicle movement resulting from uneven road surfaces and strong crosswinds will affect handling. The vehicle may also be rocked by passing buses or large trucks. Frequently check behind when moving alongside such vehicles. As soon as such vehicle movement occurs, immediately start to decelerate smoothly by slowly applying the brakes. Always steer the vehicle straight ahead while braking.

■ Passing other vehicles

Consider the total combined length of your vehicle and trailer and ensure that the vehicle-to-vehicle distance is sufficient before executing lane changes.

■ Transmission information

Refrain from driving in the 6th gear (6-speed manual transmission) or 5th gear (5-speed manual transmission), 5 range in S mode (multi-mode type automatic transmission) or D (standard type automatic transmission) to maintain the effectiveness of the engine brake and the charge performance of electrical components.

■ If the engine overheats

Towing a loaded trailer up a long, steep incline in temperatures exceeding 30°C (85°F) may result in the engine overheating. If the engine coolant temperature gauge indicates that the engine is overheating, turn the air conditioning off immediately, leave the road and stop the vehicle in a safe place. (→P. 669)

■ When parking the vehicle

Always place wheel chocks under the wheels of both the vehicle and trailer. Firmly set the parking brake and shift the shift lever to P for automatic transmissions, and 1 or R for manual transmissions.

 CAUTION

Follow all the precautions described in this section. Failure to do so could cause an accident resulting in death or serious injury.

■ Trailer towing precautions

- When towing, make sure that none of the weight limits are exceeded. (→P. 230)
- Do not use cruise control (if equipped) or dynamic radar cruise control (if equipped) when trailer towing.

■ Vehicle speed in towing

Observe the legal maximum speeds for trailer towing.

■ Before descending hills or long declines

Reduce speed and downshift. Never downshift abruptly.

■ Operation of the brake pedal

Do not hold the brake pedal depressed often or for long periods of time. Doing so may result in the brake overheating or reduce braking effects.

 NOTICE**■ For vehicles with an emergency tire puncture repair kit (if equipped)**

Do not tow anything if a tire that has been repaired using the emergency tire puncture repair kit is installed. The load on the tire may cause unexpected damage to the tire.

■ Do not directly splice trailer lights

Directly splicing trailer lights may damage your vehicle's electrical system and cause a malfunction.

Engine (ignition) switch (vehicles without a smart entry & start system)

Starting the engine

▶ Automatic transmission

- 1 Check that the parking brake is set.
- 2 Check that the shift lever is set in P.
- 3 Firmly depress the brake pedal.
- 4 Turn the engine switch to the “START” position to start the engine.

▶ Manual transmission

- 1 Check that the parking brake is set.
- 2 Check that the shift lever is set in N.
- 3 Firmly depress the clutch pedal.
- 4 Turn the engine switch to the “START” position to start the engine.

Changing the engine switch positions

① “LOCK”

The steering wheel is locked and the key can be removed. (Vehicles with an automatic transmission: The key can be removed only when the shift lever is in P.)

② “ACC”

Some electrical components such as the audio system can be used.

③ “ON”

All electrical components can be used.

④ “START”

For starting the engine.

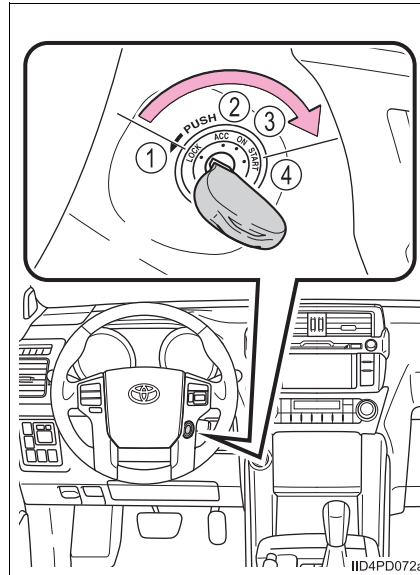

■ Turning the key from “ACC” to “LOCK”

- ① Shift the shift lever to P (automatic transmission) or N (manual transmission). (→P. 252, 259)
- ② Push in the key and turn it to the “LOCK” position.

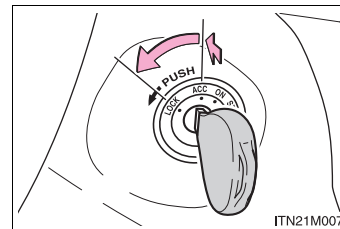

■ If the engine does not start

The engine immobilizer system may not have been deactivated. (→P. 83)
Contact any authorized Toyota dealer or repairer, or another duly qualified and equipped professional.

■ **When the steering lock cannot be released**

When starting the engine, the engine switch may seem stuck in the “LOCK” position. To free it, turn the key while turning the steering wheel slightly left and right.

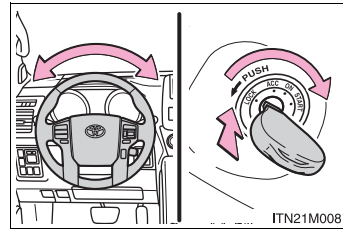

■ **Key reminder function**

A buzzer sounds if the driver’s door is opened while the engine switch is in the “LOCK” or “ACC” position to remind you to remove the key.

 CAUTION
<p>■ When starting the engine</p> <p>Always start the engine while sitting in the driver’s seat. Do not depress the accelerator pedal while starting the engine under any circumstances. Doing so may cause an accident resulting in death or serious injury.</p> <p>■ Caution when driving</p> <p>Do not turn the engine switch to the “LOCK” position while driving. If in an emergency, you must turn the engine off while the vehicle is moving, turn the engine switch only to the “ACC” position to stop the engine. An accident may result if the engine is stopped while driving. (→P. 585)</p>

 NOTICE
<p>■ To prevent battery discharge</p> <p>Do not leave the engine switch in the “ACC” or “ON” position for long periods of time without the engine running.</p> <p>■ When starting the engine</p> <ul style="list-style-type: none"> ● Do not crank the engine for more than 30 seconds at a time. This may overheat the starter and wiring system. ● Do not race a cold engine. ● If the engine becomes difficult to start or stalls frequently, have your vehicle checked by any authorized Toyota dealer or repairer, or another duly qualified and equipped professional immediately.

Engine (ignition) switch (vehicles with a smart entry & start system)

Performing the following operations when carrying the electronic key on your person starts the engine or changes engine switch modes.

Starting the engine

► Automatic transmission

- 1 Check that the parking brake is set.
- 2 Check that the shift lever is set in P.
- 3 Firmly depress the brake pedal.

The engine switch indicator will turn green.

If the indicator does not turn green, the engine cannot be started.

- 4 Press the engine switch.

The engine will crank until it starts or for up to 30 seconds, whichever is less.

Continue depressing the brake pedal until the engine is completely started.

Diesel engine only: the  indicator turns on. The engine will start after the indicator light goes out.

The engine can be started from any engine switch mode.

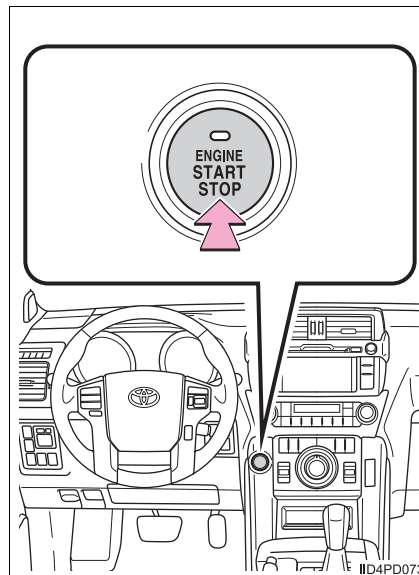

► Manual transmission

- 1 Check that the parking brake is set.
- 2 Check that the shift lever is set in N.
- 3 Firmly depress the clutch pedal.

The engine switch indicator will turn green.

If the indicator does not turn green, the engine cannot be started.

- 4 Press the engine switch.

The engine will crank until it starts or for up to 30 seconds, whichever is less.

Continue depressing the clutch pedal until the engine is completely started.

The  indicator turns on. The engine will start after the indicator light goes out.

The engine can be started from any engine switch mode.

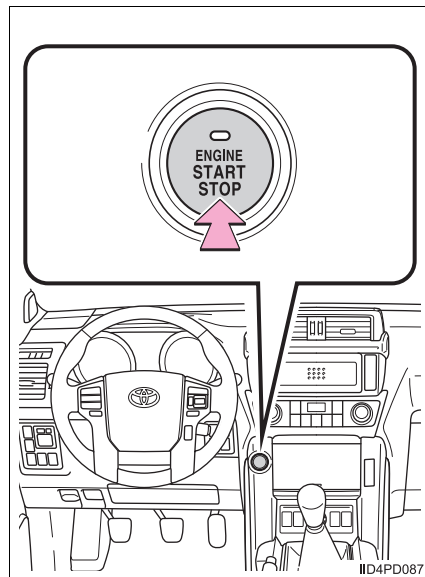

Stopping the engine

▶ Automatic transmission

- 1 Stop the vehicle.
- 2 Shift the shift lever to P.
- 3 Set the parking brake. (→P. 265)
- 4 Press the engine switch.
- 5 Release the brake pedal and check that the indicator on the engine switch is off.

▶ Manual transmission

- 1 Stop the vehicle.
- 2 Shift the shift lever to N.
- 3 Set the parking brake. (→P. 265)
- 4 Press the engine switch.
- 5 Release the brake pedal and check that the indicator on the engine switch is off.

Changing engine switch modes

Modes can be changed by pressing the engine switch with brake pedal (vehicles with an automatic transmission) or clutch pedal (vehicles with a manual transmission) released. (The mode changes each time the switch is pressed.)

① Off*

The emergency flashers can be used.

② ACCESSORY mode

Some electrical components such as the audio system can be used.

The engine switch indicator turns amber.

③ IGNITION ON mode

All electrical components can be used.

The engine switch indicator turns amber.

*: If the shift lever is in a position other than P when turning off the engine, the engine switch will be turned to ACCESSORY mode, not to off (vehicles with an automatic transmission only).

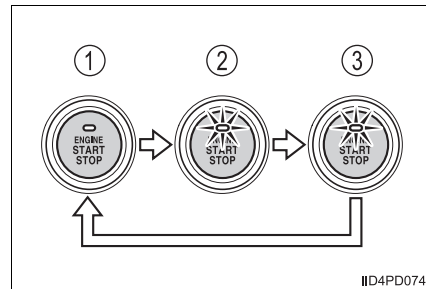

When stopping the engine with the shift lever in a position other than P (Vehicles with an automatic transmission)

If the engine is stopped with the shift lever in a position other than P, the engine switch will not be turned off but instead be turned to ACCESSORY mode. Perform the following procedure to turn the switch off:

- 1 Check that the parking brake is set.
- 2 Shift the shift lever to P.
- 3 Check that the indicator on the engine switch is illuminated in amber and then press the engine switch once.
- 4 Check that the indicator on the engine switch is off.

Auto power off function**▶ Vehicles with an automatic transmission**

When the shift lever is in P, if the vehicle is left in ACCESSORY or IGNITION ON mode with the engine not running for more than 20 minutes (ACCESSORY mode) or one hour (IGNITION ON mode), the engine switch will automatically turn off. However, this function cannot entirely prevent battery discharge. Do not leave the vehicle with the engine switch in ACCESSORY or IGNITION ON mode for long periods of time when the engine is not running.

▶ Vehicles with a manual transmission

If the vehicle is left in ACCESSORY or IGNITION ON mode with the engine not running for more than 20 minutes (ACCESSORY mode) or one hour (IGNITION ON mode), the engine switch will automatically turn off. However, this function cannot entirely prevent battery discharge. Do not leave the vehicle with the engine switch in ACCESSORY or IGNITION ON mode for long periods of time when the engine is not running.

Operation of the engine switch

When operating the engine switch, one short, firm press is enough. If the switch is pressed improperly, the engine may not start or the engine switch mode may not change. It is not necessary to press and hold the switch.

■ **Electronic key battery depletion**

→P. 160

■ **Conditions affecting operation**

→P. 157

■ **Note for the entry function**

→P. 158

■ **If the engine does not start**

The engine immobilizer system may not have been deactivated. (→P. 83)
Contact any authorized Toyota dealer or repairer, or another duly qualified and equipped professional.

■ **Steering lock**

After turning the engine switch off and opening and closing the doors, the steering wheel will be locked due to the steering lock function. Operating the engine switch again automatically cancels the steering lock.

■ **When the steering lock cannot be released**

The green indicator light on the engine switch will flash and a message will be shown on the multi-information display. Press the engine switch again while turning the steering wheel left and right.

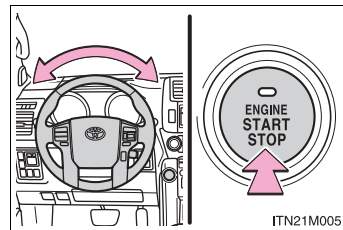

■ **Steering lock motor overheating prevention**

To prevent the steering lock motor from overheating, the motor may be suspended if the engine is turned on and off repeatedly in a short period of time. In this case, refrain from running the engine. After about 10 seconds, the steering lock motor will resume functioning.

■ **When the engine switch indicator flashes in amber**

The system may be malfunctioning. Have the vehicle inspected by any authorized Toyota dealer or repairer, or another duly qualified and equipped professional immediately.

■ **If the electronic key battery is depleted**

→P. 559

■ **If the smart entry & start system has been deactivated in a customized setting**

→P. 660

 CAUTION**■ When starting the engine**

Always start the engine while sitting in the driver's seat. Do not depress the accelerator pedal while starting the engine under any circumstances. Doing so may cause an accident resulting in death or serious injury.

■ Caution while driving

If engine failure occurs while the vehicle is moving, do not lock or open the doors until the vehicle reaches a safe and complete stop. Activation of the steering lock in this circumstance may lead to an accident, resulting in death or serious injury.

■ Stopping the engine in an emergency

If you want to stop the engine in an emergency while driving the vehicle, press and hold the engine switch for more than 2 seconds, or press it briefly 3 times or more in succession. (→P. 585)

However, do not touch the engine switch while driving except in an emergency. Turning the engine off while driving will not cause loss of steering or braking control, but the power assist to these systems will be lost. This will make it more difficult to steer and brake, so you should pull over and stop the vehicle as soon as it is safe to do so.



NOTICE

■ **To prevent battery discharge**

- Do not leave the engine switch in ACCESSORY or IGNITION ON mode for long periods of time without the engine running.
- If the indicator on the engine switch is illuminated, the engine switch is not off. When exiting the vehicle, always check that the engine switch is off.
- On vehicles with an automatic transmission, do not stop the engine when the shift lever is in a position other than P. If the engine is stopped in another shift lever position, the engine switch will not be turned off but instead be turned to ACCESSORY mode. If the vehicle is left in ACCESSORY mode, battery discharge may occur.

■ **When starting the engine**

- Do not race a cold engine.
- If the engine becomes difficult to start or stalls frequently, have your vehicle checked by any authorized Toyota dealer or repairer, or another duly qualified and equipped professional immediately.

■ **Symptoms indicating a malfunction with the engine switch**

If the engine switch seems to be operating somewhat differently than usual, such as the switch sticking slightly, there may be a malfunction. Contact any authorized Toyota dealer or repairer, or another duly qualified and equipped professional immediately.

Automatic transmission*

Shifting the shift lever

- ▶ Standard type

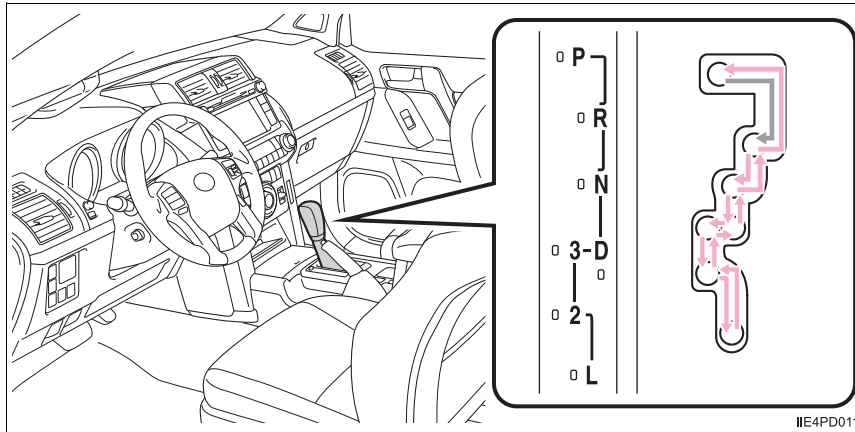

- ← While the engine switch is in the "ON" position, move the shift lever with the brake pedal depressed.

When shifting the shift lever between P and D, make sure that the vehicle is completely stopped.

*: If equipped

► Multi-mode type

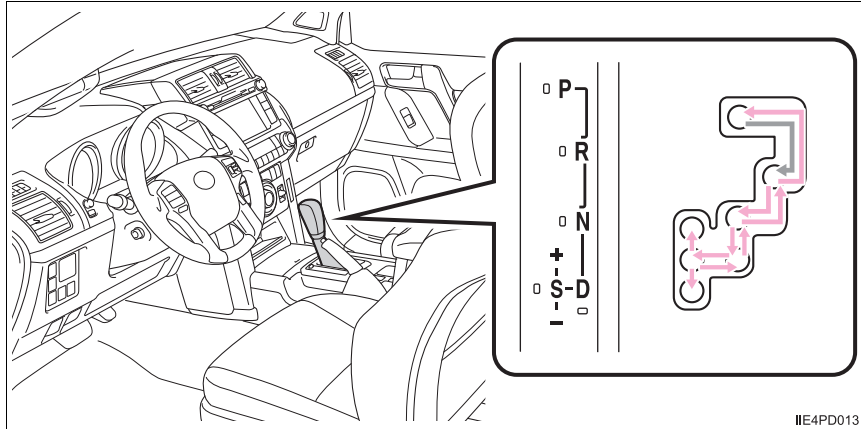

← While the engine switch is in IGNITION ON mode, move the shift lever with the brake pedal depressed.

When shifting the shift lever between P and D, make sure that the vehicle is completely stopped.

Shift position purpose

Shift position	Purpose and condition	
	Standard type	Multi-mode type
P	Parking the vehicle/starting the engine	
R	Reversing	
N	Condition in which the power is not transmitted	
D	Normal driving ^{*1}	
S	—	S mode driving ^{*2} (→P. 256)
3	Position for engine braking	—
2	Position for more powerful engine braking	—
L	Position for maximum engine braking	—

*1: Shifting to the D position allows the system to select a gear suitable for the driving conditions. Setting the shift lever to the D position is recommended for normal driving.

*2: Selecting shift ranges using S mode restricts the upper limit of the possible gear ranges, controls engine braking forces, and prevents unnecessary upshifting.

Selecting the second start mode

Use second start mode for accelerating and driving on slippery road surfaces such as snow.

► Vehicles with the multi-information display type A

Turn the “2nd STRT” button on.

Press the button again to cancel second start mode.

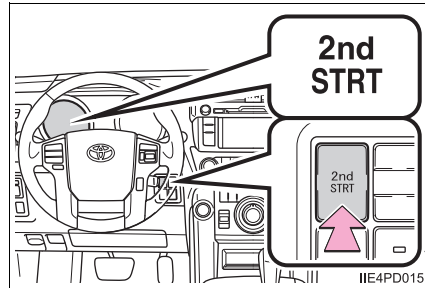

► Vehicles with the multi-information display type B

- 1 Press the menu switch.

The multi-information display will change modes to electronic features control mode.

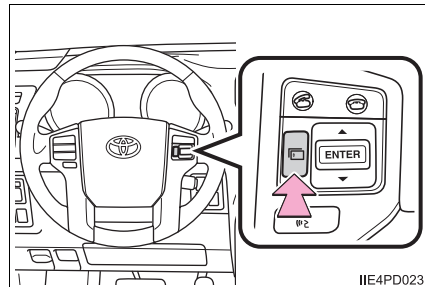

- 2 Press the “ENTER” switch upwards or downwards until “2ND START” appears.

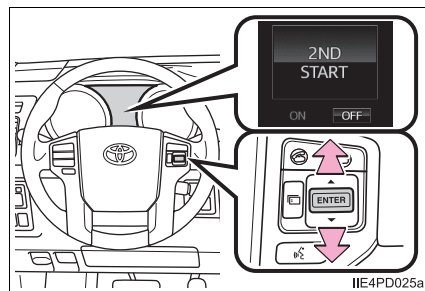

- ③ Press the “ENTER” switch to change to “ON”.
The “2nd STRT” indicator will be displayed.

Each pressing of the switch turns second start mode on and off.

Press the menu switch to change to the normal display.

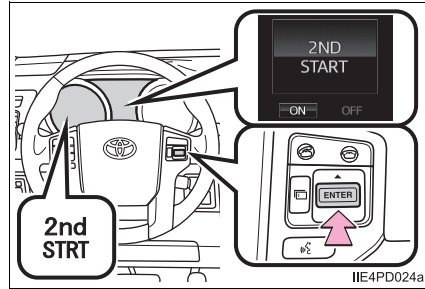

Changing shift ranges in S mode (multi-mode type)

When the shift lever is in the S position, the shift lever can be operated as follows:

- ① Upshifting
- ② Downshifting

The selected shift range, from 1 to 5, will be displayed in the meter.

The initial shift range in S mode is set automatically to 4 according to vehicle speed. However, the initial shift range may be set to 3 if AI-SHIFT has operated while the shift lever was in the D position.

(→P. 257)

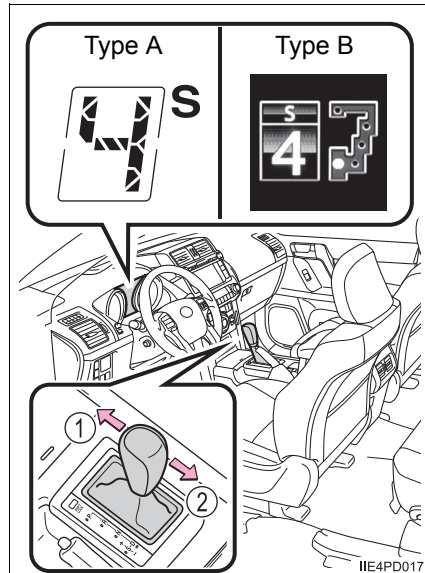

■ Shift ranges and their functions

- You can choose from 5 levels of engine braking force.
- A lower shift range will provide greater engine braking force than a higher shift range, and the engine speed will also increase.

■ **Downshifting restrictions (standard type)**

The maximum allowable speeds are as follows.

Downshifting	Transfer position	Maximum speed km/h (mph)
3 → 2	H4	105 (65)
	L4	35 (21)
2 → 1	H4	50 (31)
	L4	10 (6)

■ **Driving on a downhill**

On declines, there may be case where the vehicle shifts down automatically to obtain engine braking. As a result of the downshifting, the engine speed may increase.

■ **Second start mode automatic deactivation**

Second start mode is automatically deactivated if the engine is turned off after driving in second start mode.

■ **S mode (multi-mode type)**

When the shift range is 4 or lower, holding the shift lever toward “+” sets the shift range to 5.

■ **AI-SHIFT**

AI-SHIFT automatically selects a suitable gear according to driver performance and driving conditions.

AI-SHIFT automatically operates when the shift lever is in the D position. (Multi-mode type: Shifting the shift lever to the S position cancels the function.)

■ **When driving with the cruise control or dynamic radar cruise control (if equipped)**

Multi-mode type only: Engine braking will not occur in S mode, even when downshifting to 4. (→P. 292, 296)

■ **If the shift lever cannot be shifted from P**

→P. 659

■ **If the “S” indicator does not come on even after shifting the shift lever to S (multi-mode type)**

This may indicate a malfunction in the automatic transmission system. Have the vehicle inspected by any authorized Toyota dealer or repairer, or another duly qualified and equipped professional immediately.

(In this situation, the transmission will operate in the same manner as when the shift lever is in D.)

■ **Downshift restriction warning buzzer (S mode in multi-mode type)**

To help ensure safety and driving performance, downshifting operation may sometimes be restricted. In some circumstances, downshifting may not be possible even when the shift lever is operated. (A buzzer will sound twice.)



CAUTION

■ **When driving on slippery road surfaces**

Do not accelerate or shift gears suddenly.

Sudden changes in engine braking may cause the vehicle to spin or skid, resulting in an accident.

Manual transmission*

Shifting the shift lever

► 5-speed transmission

Fully depress the clutch pedal before operating the shift lever, and then release it slowly.

If it is difficult to shift in reverse, shift the shift lever to N, release the clutch pedal momentarily, and then try again.

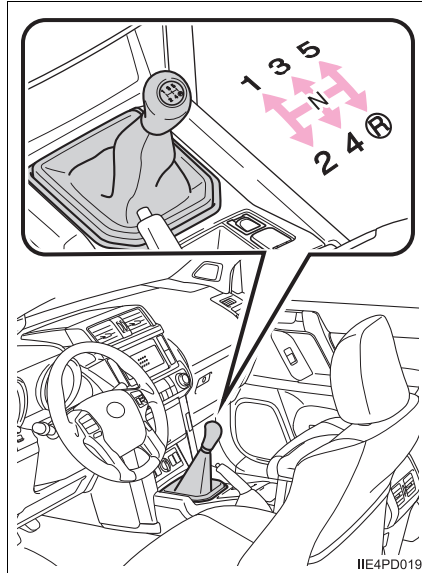

*: If equipped

► 6-speed transmission

Fully depress the clutch pedal before operating the shift lever, and then release it slowly.

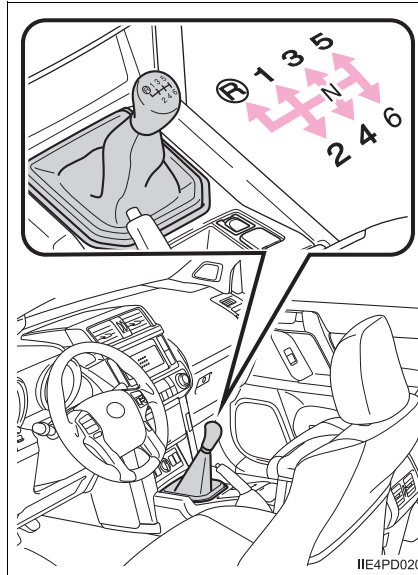

Gear Shift Indicator (if equipped)

The Gear Shift Indicator display is a guide to help the driver achieve improved fuel economy and reduced exhaust emissions within limits of engine performance.

- ① Upshifting
- ② Downshifting

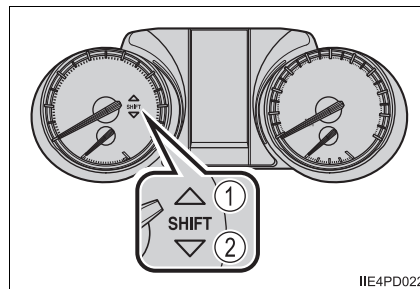

■ **Gear Shift Indicator display**

- The Gear Shift Indicator will not be displayed when the four-wheel drive control switch is in L4.
- The Gear Shift Indicator may not be displayed when your foot is placed on the clutch pedal.

■ **Maximum downshifting speeds**

Observe the downshifting speeds in the following table to prevent over-revving the engine.

▶ 5-speed transmission

Shift position	Maximum speed (km/h [mph])	
	Transfer position H4	Transfer position L4
1	45 (28)	17 (11)
2	112 (70)	44 (27)
3	119 (74)	46 (29)
4	165 (103)	67 (42)

▶ 6-speed transmission (5-door models)

Shift position	Maximum speed (km/h [mph])	
	Transfer position H4	Transfer position L4
1	38 (24)	15 (9)
2	77 (48)	30 (19)
3	105 (65)	41 (25)
4	131 (81)	51 (32)
5	157 (98)	61 (38)

▶ 6-speed transmission (3-door models)

Shift position	Maximum speed (km/h [mph])	
	Transfer position H4	Transfer position L4
1	38 (24)	15 (9)
2	102 (63)	40 (25)
3	105 (65)	41 (25)
4	131 (81)	51 (32)
5	157 (98)	61 (38)

■ **Reverse warning buzzer (vehicles with a 6-speed transmission)**

A buzzer will sound to alert the driver if the shift lever is shifted to the R position.

 **CAUTION**
■ **Gear Shift Indicator display (if equipped)**

For safety, the driver should not look only at the display. Refer to the display when it is safe to do so while considering actual traffic and road conditions. Failure to do so may lead to an accident.

 NOTICE

■ To prevent damage to the transmission

- Do not shift the shift lever to R without depressing the clutch pedal.

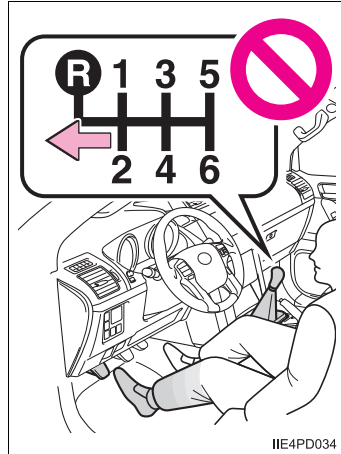

- Shift the lever to R only when the vehicle is stationary.

Turn signal lever

Operating instructions

The turn signal lever can be used to show the following intentions of the driver:

- ① Right turn
- ② Lane change to the right (push and hold the lever partway)
The right hand signals will flash until you release the lever.
- ③ Lane change to the left (push and hold the lever partway)
The left hand signals will flash until you release the lever.
- ④ Left turn

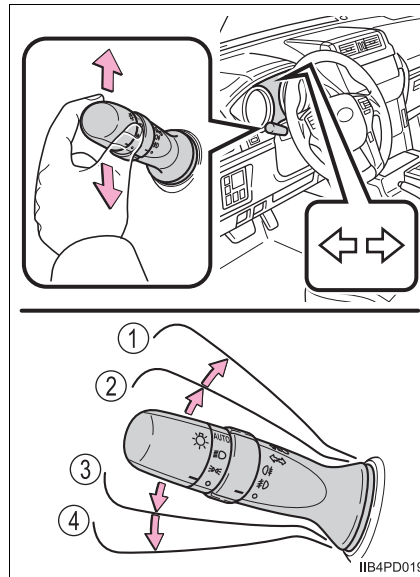

■ Turn signals can be operated when

- ▶ Vehicles without a smart entry & start system
The engine switch is in the "ON" position.
- ▶ Vehicles with a smart entry & start system
The engine switch is in IGNITION ON mode.

■ If the indicator flashes faster than usual

Check that a light bulb in the front or rear turn signal lights has not burned out.

Parking brake

- ① To set the parking brake, fully pull the parking brake lever while depressing the brake pedal.
- ② To release the parking brake, slightly raise the lever and lower it completely while pressing the button.

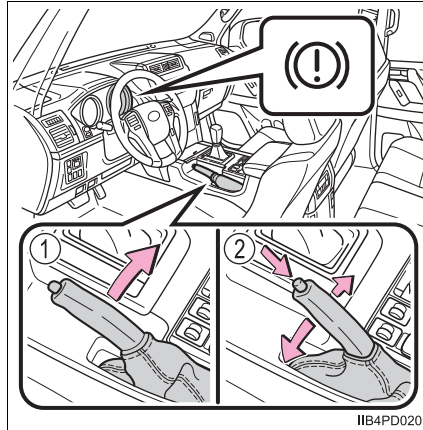

■ Usage in winter time

→P. 387

⚠ NOTICE

■ Before driving

Fully release the parking brake.

Driving the vehicle with the parking brake set will lead to brake components overheating, which may affect braking performance and increase brake wear.

Diesel Particulate Filter system (diesel engine only)*

When the deposit collected by the filter reaches a predetermined amount, it is automatically regenerated.

◆ Regeneration

Regeneration is performed as necessary in accordance with driving conditions.

◆ System characteristics

The DPF system has the following characteristics:

- Idle speed increases during regeneration
- The smell of the exhaust gas differs from that of a conventional diesel vehicle

DPF system failure warning

- If the DPF system warning light comes on (vehicles with the multi-information display type A) or the DPF system warning message “DPF FULL SEE OWNER’S MANUAL” appears on the display (vehicles with the multi-information display type B), drive continuously. (→P. 604, 616)
- If the DPF system warning light flashes (vehicles with the multi-information display type A) or the DPF system warning message “DPF FULL ENGINE SERVICE REQUIRED” appears on the display (vehicles with the multi-information display type B), have the vehicle inspected by any authorized Toyota dealer or repairer, or another duly qualified and equipped professional, immediately. (→P. 594, 607)

*: If equipped

■ Replacing the engine oil

Make sure to use an oil of the recommended grade or of matching quality. (→P. 683)

■ DPF system warning

Under the following driving conditions, the DPF system warning light or message may come on earlier than normal.*

- When only driving at low speeds (for example 20 km/h [12 mph] or below).
- If the engine is turned on and off frequently (if the engine is not left running for more than 10 minutes at a time).

*: Differs in accordance with weather, driving conditions, etc.

 **CAUTION****■ Exhaust pipe**

Do not touch the exhaust pipe during regeneration, as the exhaust pipe and exhaust gases will become particularly hot. Also, make sure that there are no people or flammable materials near the exhaust pipe while the vehicle is stopped.

Failure to do so may cause injury by burning or a fire.

■ If the malfunction indicator light comes on

The malfunction indicator light comes on if you continue driving while the DPF system warning light is flashing (vehicles with the multi-information display type A), or the DPF warning message “DPF FULL ENGINE SERVICE REQUIRED” appears on the display (vehicles with the multi-information display type B). In this event, damage may be caused to the vehicle or an accident may occur. Have the vehicle inspected by any authorized Toyota dealer or repairer, or another duly qualified and equipped professional, immediately.

 **NOTICE****■ To prevent the DPF system from failing**



- Vehicles with the multi-information display type A: Do not drive for long periods of time while the DPF system warning light is flashing
- Vehicles with the multi-information display type B: Do not drive for long periods of time while the DPF system warning message “DPF FULL ENGINE SERVICE REQUIRED” appears on the display.
- Do not use fuel other than the specified type
- Do not use engine oil other than the recommended type
- Do not modify the exhaust pipe

Headlight switch

The headlights can be operated manually or automatically.

Operating instructions

Turning the end of the lever turns on the lights as follows:

- ① ○ Vehicles without daytime running light system: Off.
Vehicles with daytime running light system: The daytime running lights turn on.
- ②  The front position, tail, license plate and instrument panel lights turn on.
- ③  The headlights and all lights listed above turn on.

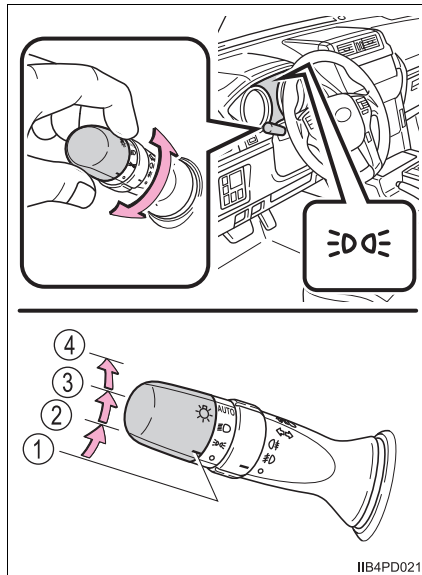

- ④ **AUTO** Vehicles without a smart entry & start system: The headlights, front position lights, daytime running lights and so on turn on and off automatically (when the engine switch is in the "ON" position.)
Vehicles with a smart entry & start system: The headlights, front position lights, daytime running lights and so on turn on and off automatically (when the engine switch is in IGNITION ON mode.)

Turning on the high beam headlights

- ① With the headlights on, push the lever away from you to turn on the high beams.

Pull the lever toward you to the center position to turn the high beams off.

- ② Pull the lever toward you and release it to flash the high beams once.

You can flash the high beams with the headlights on or off.

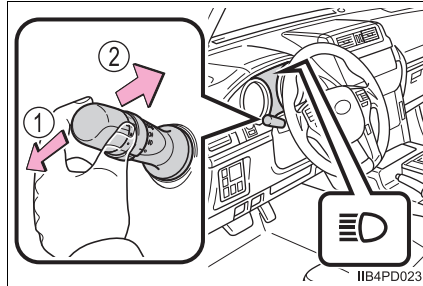
**Manual headlight leveling dial (if equipped)**

The level of the headlights can be adjusted according to the number of passengers and the loading condition of the vehicle.

- ① Raises the level of the headlights
- ② Lowers the level of the headlights

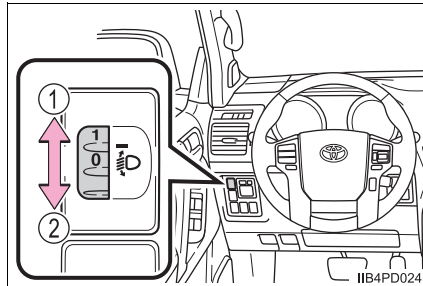

■ **Guide to dial settings**

▶ Vehicle category M1*¹

Occupancy and luggage load conditions		Dial position	
Occupants	Luggage load	9-seat models	7-seat models
Driver only, or driver and one passenger in the front seat	None	0	0
Driver, front passenger and all passengers in the rear seats farthest to the rear	None	1	1
All seats occupied	None	2.5	2
All seats occupied	Full luggage loading	3* ² 3.5* ³	2.5* ⁴ 3* ^{5, 6} 3.5* ⁷
Driver	Full luggage loading	3.5* ³ 4* ²	3* ⁵ 3.5* ^{4, 6, 7}

- *1: To distinguish the vehicle category, ask any authorized Toyota dealer or repairer, or another duly qualified and equipped professional.
- *2: KDJ150L-GKFEY, KDJ150L-GKAEY and GRJ150L-GKAEK models
- *3: TRJ150L-GKPEK and TRJ150L-GKMEK models
- *4: TX and TXL grades with a sub fuel tank of KDJ150L-GKFEY, KDJ150R-GKAEY and KDJ150R-GKFEY models, and TX grade with a sub fuel tank of GRJ150L-GKAEK model
- *5: TX grade with a sub fuel tank and TXL grade of TRJ150L-GKMEK model, and TXL grade with a sub fuel tank of TRJ150L-GKPEK model
- *6: TX and TXL grades of KDJ150L-GKFEYW, KDJ150R-GKAEYW, KDJ150R-GKFEYW and KDJ150L-GKAEY models, TX grade without a sub fuel tank and TXL grade of GRJ150L-GKAEK model, TX grade of TRJ150L-GKPEK model, TXL grade of KDJ150L-GKAEYW and GRJ150L-GKAEKW models, and TX and TXL grades without a sub fuel tank of KDJ150L-GKFEY, KDJ150R-GKAEY and KDJ150R-GKFEY models
- *7: TX grade of KDJ150L-GKAEYW model, TX grade without a sub fuel tank of TRJ150L-GKMEK model, TXL grade without a sub fuel tank of TRJ150L-GKPEK model, and TX grade without DPF catalytic converter^{*8} of KDJ150L-GKFEYW and KDJ150R-GKAEYW models
- *8: To determine whether or not your vehicle has a DPF system, contact any authorized Toyota dealer or repairer, or another duly qualified and equipped professional.

The model code is indicated on the manufacturer's label or Certification Regulation label. (→P. 679)

► Vehicle category M1*⁹

Occupancy and luggage load conditions		Dial position	
Occupants	Luggage load	5-door, 5-seat models	3-door, 5-seat models
Driver only, or driver and one passenger in the front seat	None	0	0
Driver, front passenger and all passengers in the rear seats farthest to the rear	None	1	1.5
All seats occupied	None	1	1.5
All seats occupied	Full luggage loading	3* ^{10,11} 3.5* ¹²	2.5* ¹³ 3* ¹⁴
Driver	Full luggage loading	3* ¹¹ 3.5* ^{10,12}	3* ¹³ 3.5* ¹⁴

- *9: To distinguish the vehicle category, ask any authorized Toyota dealer or repairer, or another duly qualified and equipped professional.
- *10: TX and TXL grades of KDJ150R-GKAEY model, and TXL grade of the following models:
KDJ150L-GKAEYW, KDJ150L-GKFEYW, KDJ150R-GKAEYW,
KDJ150R-GKFEYW, GRJ150L-GKAEKW, GRJ150L-GKAEK,
TRJ150L-GKPEK, KDJ150L-GKFEY
- *11: TXL grade with a sub fuel tank of TRJ150L-GKMEK model
- *12: TX and TXL grades of KDJ150R-GKFEY and KDJ150L-GKAEY models, TXL grade without a sub fuel tank of TRJ150L-GKMEK model and TX grade of the following models:
KDJ150L-GKAEYW, KDJ150L-GKFEYW, KDJ150R-GKAEYW,
KDJ150R-GKFEYW, KDJ150L-GKFEY, GRJ150L-GKAEK,
TRJ150L-GKMEK, TRJ150L-GKPEK
- *13: VX grade with a spare tire of the following models:
KDJ155L-GJAEYW, KDJ155L-GJFEYW, KDJ155R-GJAEYW,
KDJ155R-GJFEYW
- *14: VX grade without a spare tire and TX and TXL grades of the following models:
KDJ155L-GJAEYW, KDJ155L-GJFEYW, KDJ155R-GJAEYW,
KDJ155R-GJFEYW

The model code is indicated on the manufacturer's label or Certification Regulation label. (→P. 679)

▶ Vehicle category N1*15

Occupancy and luggage load conditions		Dial position	
Occupants	Luggage load	5-door models	3-door models
Driver only, or driver and one passenger in the front seat	None	0	0
Driver	Full luggage loading	3.5	3.5*16 4*17

*15: To distinguish the vehicle category, ask any authorized Toyota dealer or repairer, or another duly qualified and equipped professional.

*16: TX grade without a spare tire of KDJ155L-GJAEYW model, and TX grade with a spare tire and TXL grade of the following models: KDJ155L-GJAEYW, KDJ155L-GJFEYW, KDJ155R-GJAEYW, KDJ155R-GJFEYW

*17: TX grade without a spare tire of the following models: KDJ155L-GJFEYW, KDJ155R-GJAEYW, KDJ155R-GJFEYW

The model code is indicated on the manufacturer's label or Certification Regulation label. (→P. 679)

■ **Daytime running light system (if equipped)**

Vehicles with LED headlights: To make your vehicle more visible to other drivers, the front position lights turn on automatically whenever the engine is started.

Vehicles with halogen headlights: To make your vehicle more visible to other drivers, the headlights (at a reduced intensity) and tail lights turn on automatically whenever the engine is started.

Daytime running lights are not designed for use at night.

■ **Headlight control sensor (if equipped)**

The sensor may not function properly if an object is placed on the sensor, or anything that blocks the sensor is affixed to the windshield.

Doing so interferes with the sensor detecting the level of ambient light and may cause the automatic headlight system to malfunction.

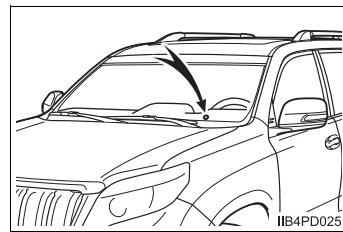



■ **Automatic light off system**

▶ Type A



● Vehicles without a smart entry & start system

All lights turn off automatically if the engine switch is turned to the “ACC” or “LOCK” position and the driver’s door is opened.



To turn the lights on again, turn the engine switch to the “ON” position, or turn the light switch off once and then back to  or .



● Vehicles with a smart entry & start system

All lights turn off if the engine switch is turned to ACCESSORY mode or turned off and the driver’s door is opened.

To turn the lights on again, turn the engine switch to IGNITION ON mode, or turn the light switch off once and then back to  or .



▶ Type B

- When the light switch is in **auto** : All lights turn off automatically if the engine switch is turned to ACCESSORY mode or turned off and a door or the glass hatch (if equipped) is opened and closed.
- When the light switch is in  or  : The headlights and front fog lights turn off automatically if the engine switch is turned to ACCESSORY mode or turned off. (A buzzer sounds if the driver's door is opened at this time.)



To turn the lights on again, turn the engine switch to IGNITION ON mode, or turn the light switch off once and then back to  or  .



▶ Type C

- When only the tail lights are on: All lights turn off if the engine switch is turned to ACCESSORY mode or turned off and the driver's door is opened.
- When the headlights are on: All lights turn off 30 seconds after a door or the glass hatch (if equipped) is opened and closed.

To turn the lights on again, turn the engine switch to IGNITION ON mode, or turn the light switch off once and then back to  or  .

▶ Type D

- When the light switch is in **auto** : All lights turn off 30 seconds after a door or the glass hatch (if equipped) is opened and closed if the engine switch is turned to ACCESSORY mode or turned off. (The lights turn off immediately if  on the key is pressed after all the doors are locked.)
- When the light switch is in  or  : The headlights and front fog lights turn off automatically if the engine switch is turned to ACCESSORY mode or turned off. (A buzzer sounds if the driver's door is opened at this time.)

To turn the lights on again, turn the engine switch to IGNITION ON mode, or turn the light switch off once and then back to  or  .

■ **Automatic headlight leveling system (if equipped)**

The level of the headlights is automatically adjusted according to the number of passengers and the loading condition of the vehicle to ensure that the headlights do not interfere with other road users.

■ **If the automatic headlight leveling system warning light flashes (if equipped)**

It may indicate a malfunction in the system. Contact any authorized Toyota dealer or repairer, or another duly qualified and equipped professional.

■ **Light reminder buzzer (if equipped)**

A buzzer sounds when the engine switch is turned off or turned to ACCESSORY mode and the driver's door is opened while the tail lights remain on.

■ **Customization**

Settings (e.g. light sensor sensitivity) can be changed.
(Customizable features →P. 705)

 NOTICE

■ **To prevent battery discharge**

Do not leave the lights on longer than necessary when the engine is not running.

Fog light switch*

The fog lights secure excellent visibility in difficult driving conditions, such as in rain and fog.

► Front and rear fog light switch

- ① ○ Turns the front and rear fog lights off
- ② ㊦ Turns the front fog lights on
- ③ ㊧ Turns both front and rear fog lights on

Releasing the switch ring returns it to ㊦.

Operating the switch ring again turns only the rear fog lights off.

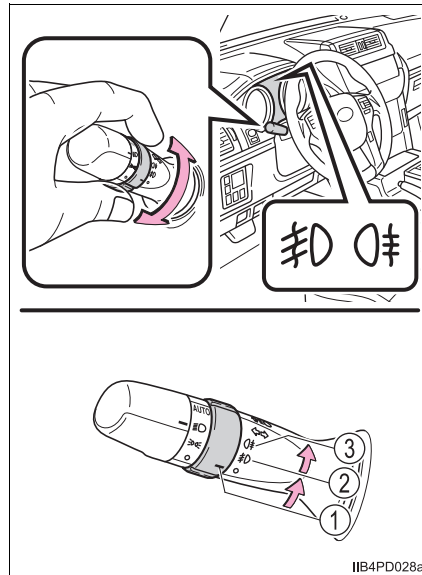

4

Driving

*: If equipped

► Rear fog light switch

- ① ○ Turns the rear fog lights off
- ②  Turns the rear fog lights on
Releasing the switch ring returns it to ○ .

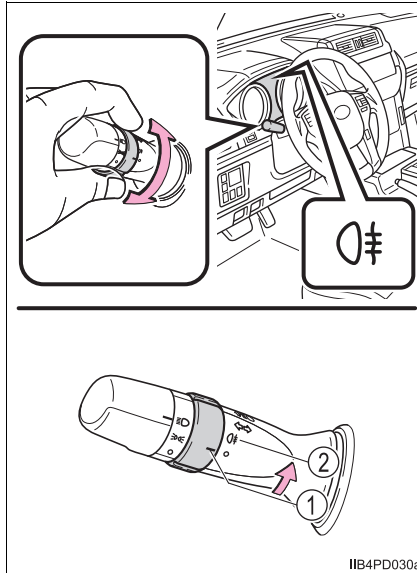

■ Fog lights can be used when

- Vehicles with front and rear fog lights

Front fog lights: The headlights or front position lights are turned on.

Rear fog lights: The front fog lights are turned on.

- Vehicles with rear fog lights only

The headlights or front position lights are turned on.

Windshield wipers and washer

Operating the wiper lever

The wiper operation is selected by moving the lever as follows.

► Intermittent windshield wipers with interval adjuster

- ① Intermittent operation
- ② Low speed operation
- ③ High speed operation
- ④ Temporary operation

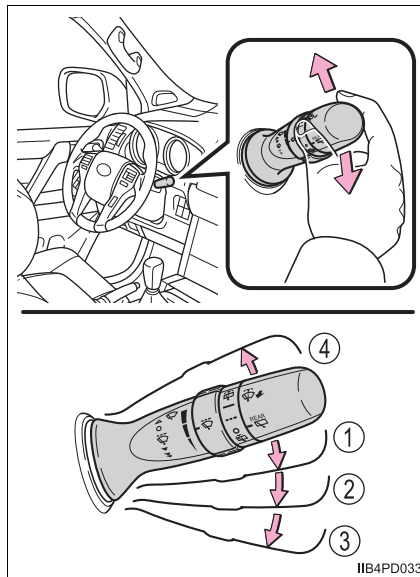

Wiper intervals can be adjusted when intermittent operation is selected.

- ⑤ Increases the intermittent windshield wiper frequency
- ⑥ Decreases the intermittent windshield wiper frequency

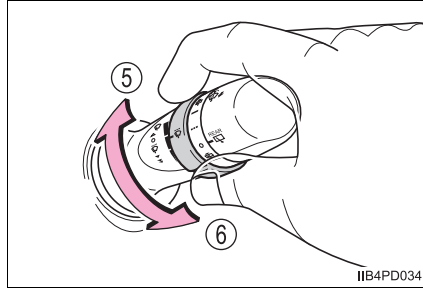

- ⑦ Washer/wiper dual operation
The wipers will automatically operate a couple of times after the washer squirts.
Vehicles with headlight cleaners: If the headlights are on, the headlight cleaners will operate once.

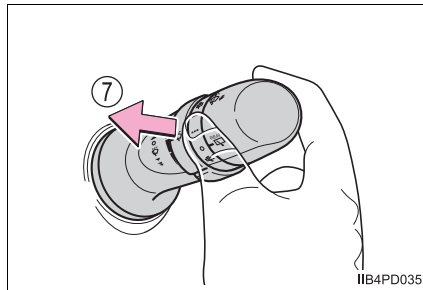

► Rain-sensing windshield wipers

- ① Rain-sensing operation (“AUTO”)
- ② Low speed operation
- ③ High speed operation
- ④ Temporary operation

When “AUTO” is selected, the wipers will operate automatically when the sensor detects falling rain. The system automatically adjusts wiper timing in accordance with rain volume and vehicle speed.

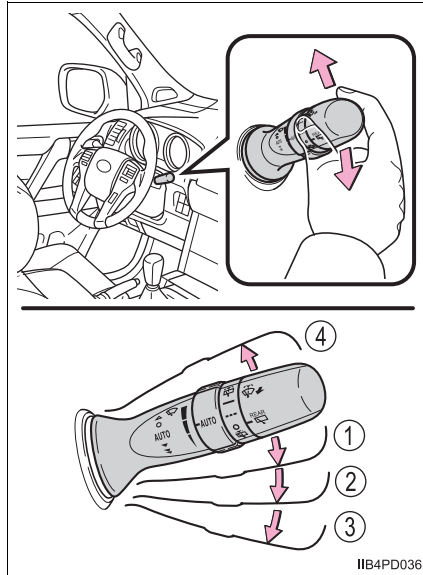

The sensor sensitivity can be adjusted when "AUTO" is selected.

- ⑤ Increases the sensitivity
- ⑥ Decreases the sensitivity

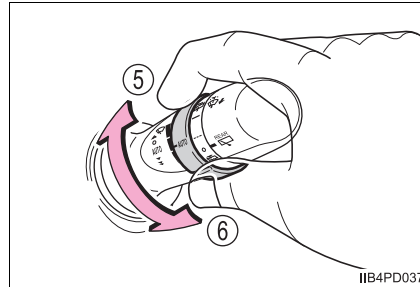

- ⑦ Washer/wiper dual operation
The wipers operate automatically.
(After operating several times, the wipers operate one more time after a short delay to prevent dripping.)
Vehicles with headlight cleaners: If the headlights are on, the headlight cleaners will operate once.

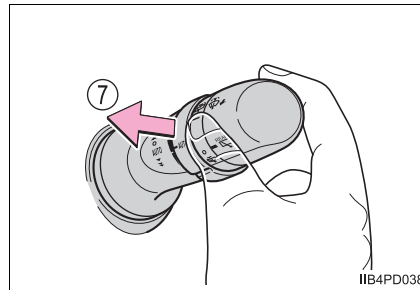

■ **The windshield wiper and washer can be operated when**

- ▶ Vehicles without a smart entry & start system
The engine switch is in the “ON” position.
- ▶ Vehicles with a smart entry & start system
The engine switch is in IGNITION ON mode.

■ **Raindrop sensor (vehicles with rain-sensing windshield wipers)**

- The raindrop sensor judges the amount of raindrops.

An optical sensor is adopted. It may not operate properly when sunlight from the rising or setting of the sun intermittently strikes the windshield, or if bugs etc. are present on the windshield.

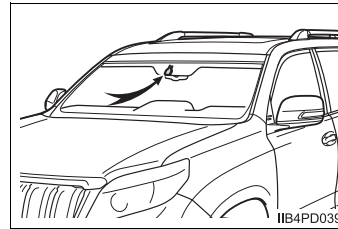

- If the wiper switch is turned to the “AUTO” position while the engine switch is in IGNITION ON mode, the wipers will operate once to show that “AUTO” mode is activated.
- When the sensor sensitivity ring is turned toward high while in “AUTO” mode, the wipers will operate once to indicate that the sensor sensitivity is enhanced.
- If the temperature of the raindrop sensor is 90°C (194°F) or higher, or -15°C (5°F) or lower, automatic operation may not occur. In this case, operate the wipers in any mode other than “AUTO”.

■ **Effects of vehicle speed on wiper operation (vehicles with rain-sensing windshield wipers)**

With the settings other than “AUTO” also, the time until drip prevention wiper sweep occurs is changed depending on vehicle speed.

With the low speed operation selected, wiper operation will be switched from low speed to intermittent wiper operation only when the vehicle is stationary. (However, when the sensor sensitivity is adjusted to the highest level, the mode cannot be switched.)

■ **If no windshield washer fluid sprays**

Check that the washer nozzles are not blocked if there is washer fluid in the windshield washer fluid reservoir.

 CAUTION

■ **Caution regarding the use of windshield wipers in “AUTO” mode (vehicles with rain-sensing windshield wipers)**

The windshield wipers may operate unexpectedly if the sensor is touched or the windshield is subject to vibration in “AUTO” mode. Take care that your fingers or anything else does not become caught in the windshield wipers.

■ **Caution regarding the use of washer fluid**

When it is cold, do not use the washer fluid until the windshield becomes warm. The fluid may freeze on the windshield and cause low visibility. This may lead to an accident, resulting in death or serious injury.

 NOTICE

■ **When the windshield is dry**

Do not use the wipers, as they may damage the windshield.

■ **When the washer fluid tank is empty**

Do not operate the switch continually as the washer fluid pump may over-heat.

■ **When there is no washer fluid spray from the nozzle**



Damage to the washer fluid pump may be caused if the lever is pulled toward you and held continually.

■ **When a nozzle becomes blocked**

Do not try to clear it with a pin or other object. The nozzle will be damaged.

Rear window wiper and washer

Turning the end of the lever turns on the rear window wiper and washer.

- ① - - - Intermittent operation
- ② — Normal operation
- ③  Washer/wiper dual operation
- ④  Washer/wiper dual operation

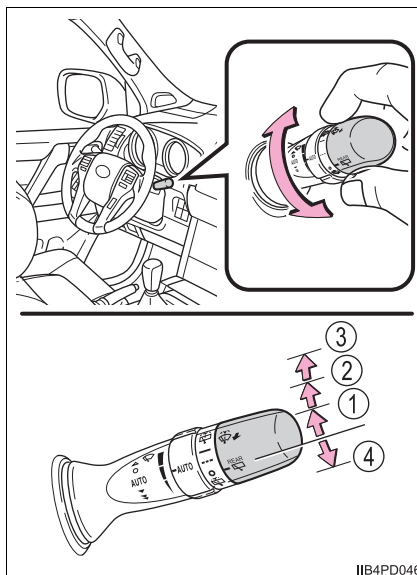

4

Driving

■ The rear window wiper and washer can be operated when

- Vehicles without a smart entry & start system: The engine switch is in the "ON" position.

Vehicles with a smart entry & start system: The engine switch is in IGNITION ON mode.

- The glass hatch (if equipped) is closed.

■ If no washer fluid sprays

Check that the washer nozzles are not blocked if there is washer fluid in the washer fluid reservoir.

NOTICE

■ When the rear window is dry

Do not use the wiper, as it may damage the rear window.

■ When the washer fluid tank is empty

Do not operate the switch continually as the washer fluid pump may over-heat.

Headlight cleaner switch*

Washer fluid can be sprayed on the headlights.

Press the switch to clean the headlights.

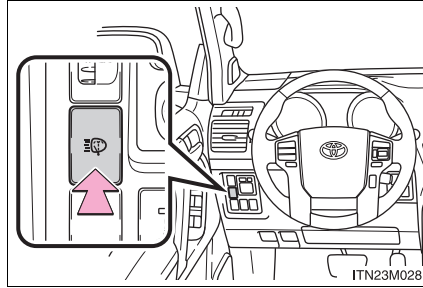

■ The headlight cleaners can be operated when

- ▶ Vehicles without a smart entry & start system

The engine switch is in the "ON" position and the headlight switch is turned on.

If equipped, the headlight switch is in the "AUTO" position and the headlight is on.

- ▶ Vehicles with a smart entry & start system

The engine switch is in IGNITION ON mode and the headlight switch is turned on.

If equipped, the headlight switch is in the "AUTO" position and the headlight is on.

*: If equipped

■ Windshield washer linked operation**▶ Vehicles without a smart entry & start system**

When the windshield washer is operated with the engine switch is in the "ON" position and the headlight on, the headlight cleaners will operate once. (→P. 280)

▶ Vehicles with a smart entry & start system

When the windshield washer is operated with the engine switch is in IGNITION ON mode and the headlight on, the headlight cleaners will operate once. (→P. 280)

**NOTICE****■ When the washer fluid tank is empty**

Do not press the switch continually as the washer fluid pump may overheat.

Opening the fuel tank cap

Perform the following steps to open the fuel tank cap.

Before refueling the vehicle

- Close all the doors and windows, and turn the engine switch to the “LOCK” position (vehicles without a smart entry & start system) or off (vehicles with a smart entry & start system).
- Confirm the type of fuel.

■ Fuel types

▶ 1GR-FE engine

EU area:

Unleaded gasoline conforming to European standard EN228, Research Octane Number of 95 or higher.

Except EU area:

Unleaded gasoline, Research Octane Number of 95 or higher.

▶ 2TR-FE engine

EU area:

Unleaded gasoline conforming to European standard EN228, Research Octane Number of 91 or higher.

Except EU area:

Unleaded gasoline, Research Octane Number of 91 or higher.

▶ 1KD-FTV engine

EU area:

Diesel fuel conforming to European standard EN590.

Except EU area:

Without DPF system*

Diesel fuel that contains 350 ppm or less of sulfur and has a cetane number of 48 or higher.

With DPF system*

Diesel fuel that contains 50 ppm or less of sulfur and has a cetane number of 48 or higher.

*: To determine whether or not your vehicle has a DPF system, contact any authorized Toyota dealer or repairer, or another duly qualified and equipped professional.

■ Use of ethanol blended gasoline in a gasoline engine

Toyota allows the use of ethanol blended gasoline where the ethanol content is up to 10 %. Make sure that the ethanol blended gasoline to be used has a Research octane number that follows the above.

 **CAUTION****■ When refueling the vehicle**

Observe the following precautions while refueling the vehicle. Failure to do so may result in death or serious injury.

- After exiting the vehicle and before opening the fuel door, touch an unpainted metal surface to discharge any static electricity. It is important to discharge static electricity before refueling because sparks resulting from static electricity can cause fuel vapors to ignite while refueling.
- Always hold the grips on the fuel tank cap and turn it slowly to remove it. A whooshing sound may be heard when the fuel tank cap is loosened. Wait until the sound cannot be heard before fully removing the cap. In hot weather, pressurized fuel may spray out of the filler neck and cause injury.
- Do not allow anyone that has not discharged static electricity from their body to come close to an open fuel tank.
- Do not inhale vaporized fuel.
Fuel contains substances that are harmful if inhaled.
- Do not smoke while refueling the vehicle.
Doing so may cause the fuel to ignite and cause a fire.
- Do not return to the vehicle or touch any person or object that is statically charged.
This may cause static electricity to build up, resulting in a possible ignition hazard.

 CAUTION**■ When refueling**

Observe the following precautions to prevent fuel overflowing from the fuel tank:

- Securely insert the fuel nozzle into the fuel filler neck.
- Stop filling the tank after the fuel nozzle automatically clicks off.
- Do not top off the fuel tank.

 NOTICE**■ Refueling**

Do not spill fuel during refueling.

Doing so may damage the vehicle, such as causing the emission control systems to operate abnormally or damaging fuel system components or the vehicle's painted surface.

Opening the fuel tank cap

- 1 Pull up the opener to open the fuel filler door.

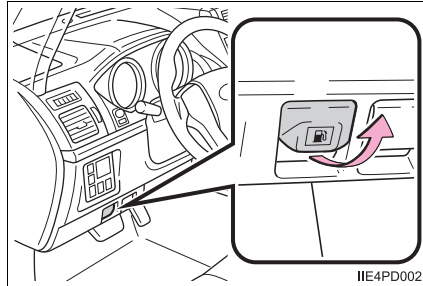

- 2 Turn the fuel tank cap slowly to open, and hang the fuel tank cap on the back of the fuel filler door.

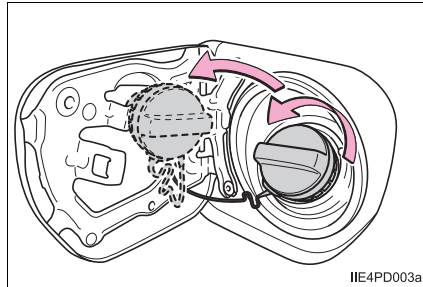

Closing the fuel tank cap

After refueling, turn the fuel tank cap until you hear a click. Once the cap is released, it will turn slightly in the opposite direction.

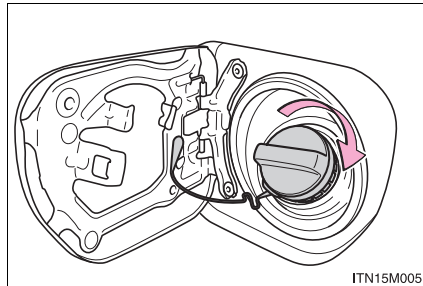

⚠ CAUTION

■ When replacing the fuel tank cap

Do not use anything but a genuine Toyota fuel tank cap designed for your vehicle. Doing so may cause a fire or other incident which may result in death or serious injury.

Cruise control*

Summary of functions

Use the cruise control to maintain a set speed without depressing the accelerator pedal.

- ① Indicators
- ② Cruise control switch

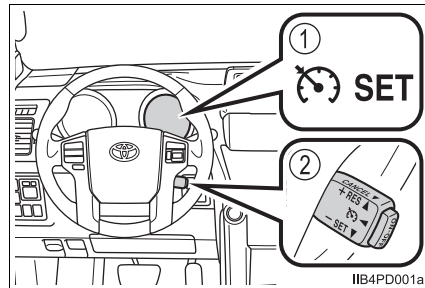

Setting the vehicle speed

- 1 Press the “ON-OFF” button to activate the cruise control.
Cruise control indicator will come on.
Press the button again to deactivate the cruise control.

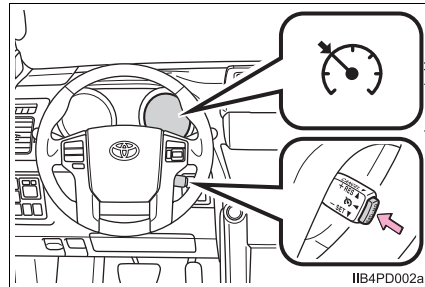

- 2 Accelerate or decelerate the vehicle to the desired speed, and push the lever down to set the speed.
“SET” indicator will come on.
The vehicle speed at the moment the lever is released becomes the set speed.

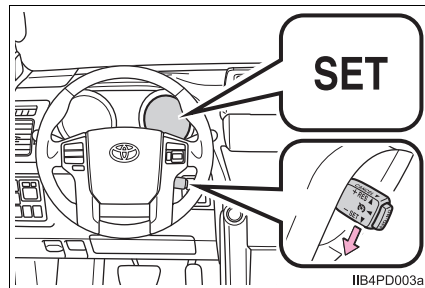

*: If equipped

Adjusting the set speed

To change the set speed, operate the lever until the desired set speed is obtained.

- ① Increases the speed
- ② Decreases the speed

Fine adjustment: Momentarily move the lever in the desired direction.

Large adjustment: Hold the lever in the desired direction.

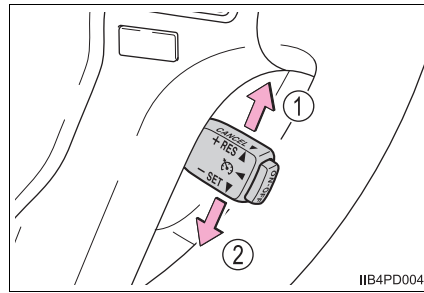

The set speed will be increased or decreased as follows:

Fine adjustment: By approximately 1.6 km/h (1 mph) each time the lever is operated.

Large adjustment: The set speed can be increased or decreased continually until the lever is released.

Canceling and resuming the constant speed control

- ① Pulling the lever toward you cancels the constant speed control.

The speed setting is also canceled when the brakes are applied or the clutch pedal (manual transmission only) is depressed.

- ② Pushing the lever up resumes the constant speed control.

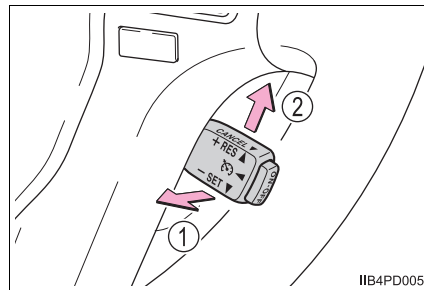

Resuming is available when the vehicle speed is more than approximately 40 km/h (25 mph).

■ **Cruise control can be set when**

- The shift lever is in the D or range 4 or higher of S has been selected (vehicles with an automatic transmission).
- Vehicle speed is above approximately 40 km/h (25 mph).

■ **Accelerating after setting the vehicle speed**

- The vehicle can be accelerated normally. After acceleration, the set speed resumes.
- Even without canceling the cruise control, the set speed can be increased by first accelerating the vehicle to the desired speed and then pushing the lever down to set the new speed.

■ **Automatic cruise control cancelation**

Cruise control will stop maintaining the vehicle speed in any of the following situations:

- Actual vehicle speed falls more than approximately 16 km/h (10 mph) below the preset vehicle speed.
At this time, the memorized set speed is not retained.
- Actual vehicle speed is below approximately 40 km/h (25 mph).
- VSC is activated.

■ **If the warning message for the cruise control is shown on the multi-information display or the cruise control indicator light turns to yellow**

Press the "ON-OFF" button once to deactivate the system, and then press the button again to reactivate the system.

If the cruise control speed cannot be set or if the cruise control cancels immediately after being activated, there may be a malfunction in the cruise control system. Have the vehicle inspected by any authorized Toyota dealer or repairer, or another duly qualified and equipped professional.

 CAUTION**■ To avoid operating the cruise control by mistake**

Switch the cruise control off using the “ON-OFF” button when not in use.

■ Situations unsuitable for cruise control

Do not use cruise control in any of the following situations.

Doing so may result in loss of control and could cause an accident resulting in death or serious injury.

- In heavy traffic
- On roads with sharp bends
- On winding roads
- On slippery roads, such as those covered with rain, ice or snow
- On steep hills
Vehicle speed may exceed the set speed when driving down a steep hill.
- When your vehicle is towing a trailer (with towing hitch) or during emergency towing

Dynamic radar cruise control*

Summary of functions

Dynamic radar cruise control supplements conventional cruise control with a vehicle-to-vehicle distance control. In vehicle-to-vehicle distance control mode, the vehicle automatically accelerates or decelerates in order to maintain a set following distance from vehicles ahead.

- ① Display
- ② Set speed
- ③ Indicators
- ④ Vehicle-to-vehicle distance button
- ⑤ Cruise control switch

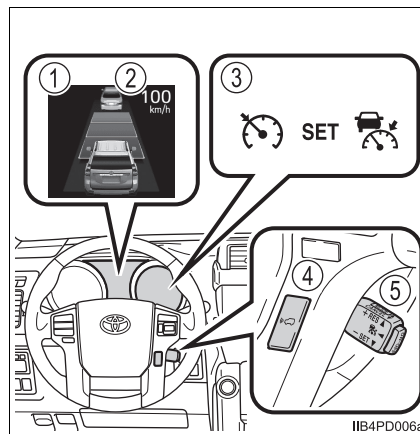

*: If equipped

Setting the vehicle speed (vehicle-to-vehicle distance control mode)

- 1 Press the “ON-OFF” button to activate the cruise control.
Dynamic radar cruise control indicator will come on.
Press the button again to deactivate the cruise control.

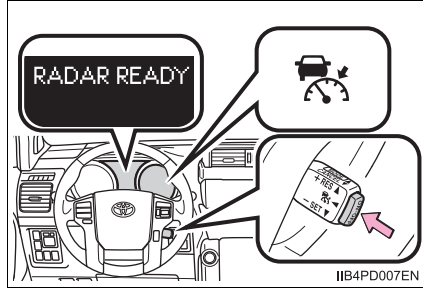

- 2 Accelerate or decelerate the vehicle to the desired speed, and push the lever down to set the speed.
“SET” indicator will come on.
The vehicle speed at the moment the lever is released becomes the set speed.

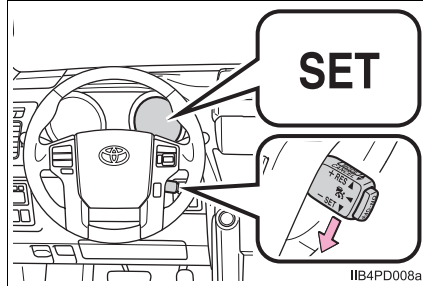

Adjusting the set speed

To change the set speed, operate the lever until the desired set speed is displayed.

- ① Increases the speed
- ② Decreases the speed

Fine adjustment: Momentarily move the lever in the desired direction.

Large adjustment: Hold the lever in the desired direction.

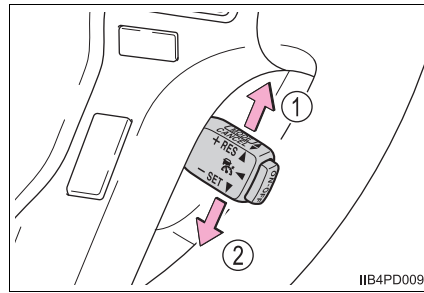

In the vehicle-to-vehicle distance control mode, the set speed will be increased or decreased as follows:

- When the set speed is shown in “MPH”
 - Fine adjustment: By approximately 1.6 km/h (1 mph) each time the lever is operated
 - Large adjustment: By approximately 8 km/h (5 mph) for each 0.75 seconds the lever is held
- When the set speed is shown in “km/h”
 - Fine adjustment: By approximately 1 km/h (0.6 mph) each time the lever is operated
 - Large adjustment: By approximately 5 km/h (3.1 mph) for each 0.75 seconds the lever is held

In the constant speed control mode (→P. 304), the set speed will be increased or decreased as follows:

Fine adjustment: By approximately 1.6 km/h (1 mph) each time the lever is operated

Large adjustment: The set speed can be increased or decreased continually until the lever is released.

Changing the vehicle-to-vehicle distance

Pressing the button changes the vehicle-to-vehicle distance as follows:

- ① Long
- ② Medium
- ③ Short

The vehicle-to-vehicle distance is set automatically to long mode when the engine switch is turned to IGNITION ON mode.

If a vehicle is running ahead of you, the preceding vehicle mark will also be displayed.

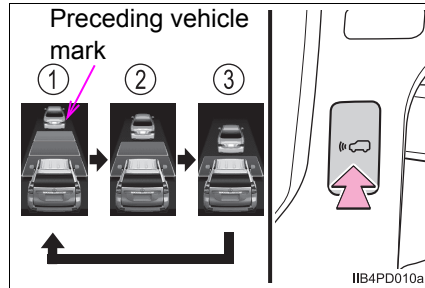

Vehicle-to-vehicle distance settings

Select a distance from the table below. Note that the distances shown correspond to a vehicle speed of 80 km/h (50 mph). Vehicle-to-vehicle distance increases/decreases in accordance with vehicle speed.

Distance options	Vehicle-to-vehicle distance
Long	Approximately 50 m (160 ft.)
Medium	Approximately 40 m (130 ft.)
Short	Approximately 30 m (100 ft.)

Canceling and resuming the speed control

- ① Pulling the lever toward you cancels the cruise control.
The speed setting is also canceled when the brakes are applied.
- ② Pushing the lever up resumes the cruise control and returns vehicle speed to the set speed.
Resuming is available when the vehicle speed is more than approximately 40 km/h (25 mph).

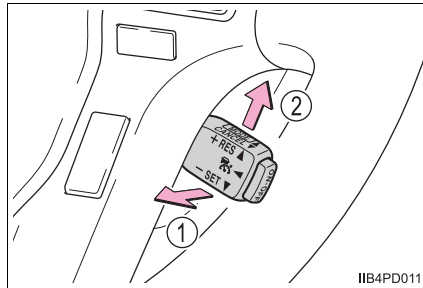

Driving in vehicle-to-vehicle distance control mode

This mode employs a radar sensor to detect the presence of vehicles up to approximately 120 m (400 ft.) ahead, determines the current vehicle-to-vehicle following distance, and operates to maintain a suitable following distance from the vehicle ahead.

Note that vehicle-to-vehicle distance will close in when traveling on long downhill slopes.

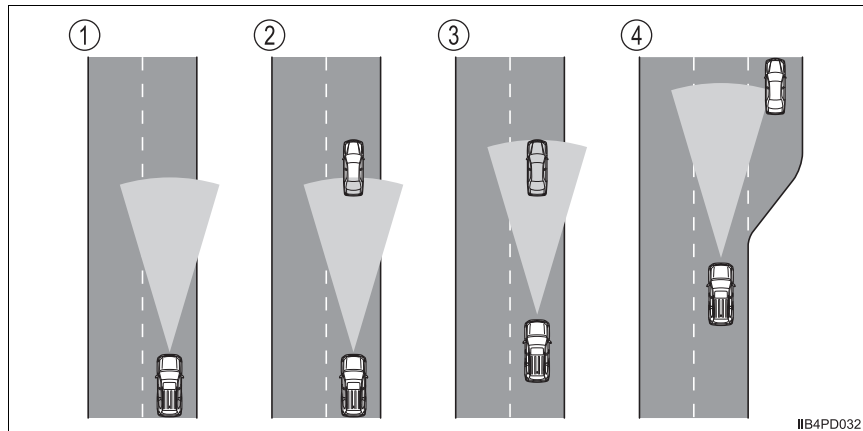

- ① Example of constant speed cruising
When there are no vehicles ahead
The vehicle travels at the speed set by the driver. The desired vehicle-to-vehicle distance can also be set by operating the vehicle-to-vehicle distance control.
- ② Example of deceleration cruising
When the vehicle ahead is driving slower than the set speed
When a vehicle is detected running ahead of you the system automatically decelerates your vehicle. When a greater reduction in vehicle speed is necessary, the system applies the brakes. A warning tone warns you when the system cannot decelerate sufficiently to prevent your vehicle from closing in on the vehicle ahead.
- ③ Example of follow-up cruising
When following a vehicle driving slower than the set speed
The system continues follow-up cruising while adjusting for changes in the speed of the vehicle ahead in order to maintain the vehicle-to-vehicle distance set by the driver.
- ④ Example of acceleration
When there are no longer are vehicles ahead driving slower than the set speed
The system accelerates until the set speed is reached. The system then returns to constant speed cruising.

Approach warning

When your vehicle is too close to a vehicle ahead, and sufficient automatic deceleration via the cruise control is not possible, the display will flash and the buzzer will sound to alert the driver. An example of this would be if another driver cuts in front of you while you are following a vehicle. Apply the brakes to ensure an appropriate vehicle-to-vehicle distance.

■ Warnings may not occur when

In the following instances, there is a possibility that the warnings will not occur:

- When the speed of the vehicle ahead matches or exceeds your vehicle speed
- When the vehicle ahead is traveling at an extremely slow speed
- Immediately after the cruise control speed was set
- At the instant the accelerator is applied

Selecting conventional constant speed control mode

Constant speed control mode differs from vehicle-to-vehicle distance control mode. When constant speed control mode is selected, your vehicle will maintain a set speed regardless of whether or not there are other vehicles in the lane ahead.

- ① Press the “ON-OFF” button to activate the cruise control.

Press the button again to deactivate the cruise control.

- ② Switch to constant speed control mode. (Push the lever forward and hold for approximately 1 second.)

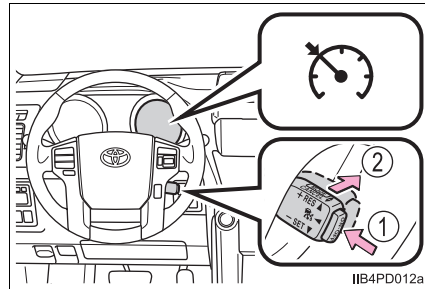

Constant speed control mode indicator will come on.

When in constant speed control mode, to return to vehicle-to-vehicle distance control mode, push the lever forward again and hold for approximately 1 second.

After the desired speed has been set, it is not possible to return to vehicle-to-vehicle distance control mode.

If the engine switch is turned off and then turned to IGNITION ON mode again, the vehicle will automatically return to vehicle-to-vehicle distance control mode.

Adjusting the speed setting: →P. 294

Canceling and resuming the speed setting: →P. 294

■ **Dynamic radar cruise control can be set when**

- The shift lever is in the D or range 4 or higher of S has been selected.
- Vehicle speed is above approximately 50 km/h (30 mph).

■ **Switching modes**

The mode cannot be switched to constant speed control mode if vehicle-to-vehicle distance control mode has been used. The mode also cannot be switched from constant speed control to vehicle-to-vehicle distance control mode. Turn the system off by pressing the “ON-OFF” button, and turn it on again.

■ **Accelerating after setting the vehicle speed**

The vehicle can be accelerated normally. After acceleration, the set speed resumes. However, during vehicle-to-vehicle distance control mode, the vehicle speed may decrease below the set speed in order to maintain the distance to the vehicle ahead.

■ **Automatic cancelation of vehicle-to-vehicle distance control**

Vehicle-to-vehicle distance control driving is automatically canceled in the following situations:

- Actual vehicle speed falls below approximately 40 km/h (25 mph).
- VSC is activated.
- The sensor cannot operate correctly because it is covered in some way.
- The windshield wipers are operating at high speed (when the wiper switch is set to the “AUTO” mode or the high speed wiper operation position).
- When second start mode is set.
- Bad weather causes the detection function to become extremely unstable.

If vehicle-to-vehicle distance control driving is automatically canceled for any other reason, there may be a malfunction in the system. Contact any authorized Toyota dealer or repairer, or another duly qualified and equipped professional.

■ Automatic cancelation of constant speed control

The cruise control will stop maintaining the vehicle speed in the following situations:

- Actual vehicle speed is more than approximately 16 km/h (10 mph) below the set vehicle speed.
At this time, the memorized set speed is not retained.
- Actual vehicle speed falls below approximately 40 km/h (25 mph).
- VSC is activated.

■ Radar sensor and grille cover

Always keep the sensor and grille cover clean to ensure that the vehicle-to-vehicle distance control operates properly. (Some obstructions, such as snow, ice and plastic objects, cannot be detected by the obstruction sensor.) Dynamic radar cruise control is canceled if an obstruction is detected.

- ① Grille cover
- ② Radar sensor

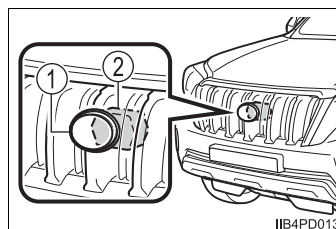
**■ Warning messages and buzzers for dynamic radar cruise control**

Warning messages and buzzers are used to indicate a system malfunction or to inform the driver of the need for caution while driving. (→P. 606)

■ Certification



The latest “DECLARATION of CONFORMITY” (DoC) is available at the following:

<http://www.globaldenso.com/en/products/oem/index.html#2>

<p>Hereby, DENSO CORPORATION declares that this DNMWR004 is in compliance with the essential requirements and other relevant provisions of Directive 1999/5/EC.</p>
<p>Hér með lýsir DENSO CORPORATION yfir því að DNMWR004 er í samræmi við grunnkröfur og aðrar kröfur, sem gerðar eru í tilskipun 1999/5/EC.</p>
<p>Con la presente DENSO CORPORATION dichiara che questo DNMWR004 è conforme ai requisiti essenziali ed alle altre disposizioni pertinenti stabilite dalla direttiva 1999/5/CE.</p>
<p>Käesolevaga kinnitab DENSO CORPORATION seadme DNMWR004 vastavust direktiivi 1999/5/EÜ põhinõuetele ja nimetatud direktiivist tulenevatele teistele asjakohastele sätetele.</p>
<p>Hierbij verklaart DENSO CORPORATION dat het toestel DNMWR004 in overeenstemming is met de essentiële eisen en de andere relevante bepalingen van richtlijn 1999/5/EG.</p>
<p>ΜΕ ΤΗΝ ΠΑΡΟΥΣΑ DENSO CORPORATION ΔΗΛΩΝΕΙ ΟΤΙ DNMWR004 ΣΥΜΜΟΡΦΩΝ ΕΤΑΙ ΠΡΟΣ ΤΙΣ ΟΥΣΙΩΔΕΙΣ ΑΠΑΙΤΗΣΕΙΣ ΚΑΙ ΤΙΣ ΛΟΙΠΕΣ ΣΧΕΤΙΚΕΣ ΔΙΑΤΑΞΕΙΣ ΤΗΣ ΟΔΗΓΙΑΣ 1999/5/ΕΚ.</p>
<p>Härmed intygar DENSO CORPORATION att denna DNMWR004 står i överensstämmelse med de väsentliga egenskapskrav och övriga relevanta bestämmelser som framgår av direktiv 1999/5/EG.</p>
<p>Por medio de la presente DENSO CORPORATION declara que el DNMWR004 cumple con los requisitos esenciales y cualesquiera otras disposiciones aplicables o exigibles de la Directiva 1999/5/CE.</p>
<p>DENSO CORPORATION tímto vyhlasuje, že DNMWR004 spĺňa základné požiadavky a všetky príslušné ustanovenia Smernice 1999/5/ES.</p>
<p>DENSO CORPORATION izjavlja, da je ta DNMWR004 v skladu z bistvenimi zahtevami in ostalimi relevantnimi določili direktive 1999/5/ES.</p>
<p>DENSO CORPORATION tímto prohlašuje, že tento DNMWR004 je ve shodě se základními požadavky a dalšími příslušnými ustanoveními směrnice 1999/5/ES.</p>

Undertegnede DENSO CORPORATION erklærer herved, at følgende udstyr DNMWR004 overholder de væsentlige krav og øvrige relevante krav i direktiv 1999/5/EF.
Hiermit erklært DENSO CORPORATION, dass sich das Gerät DNMWR004 in Übereinstimmung mit den grundlegenden Anforderungen und den übrigen einschlägigen Bestimmungen der Richtlinie 1999/5/EG befindet.
DENSO CORPORATION erklærer herved at udstyret DNMWR004 er i samsvar med de grunnleggende krav og øvrige relevante krav i direktiv 1999/5/EF.
Alulírott, DENSO CORPORATION nyilatkozom, hogy a DNMWR004 megfelel a vonatkozó alapvető követelményeknek és az 1999/5/EC irányelv egyéb előírásainak.
DENSO CORPORATION vakuuttaa täten että DNMWR004 tyyppinen laite on direktiivin 1999/5/EY oleellisten vaatimusten ja sitä koskevien direktiivin muiden ehtojen mukainen.
Par la présente DENSO CORPORATION déclare que l'appareil DNMWR004 est conforme aux exigences essentielles et aux autres dispositions pertinentes de la directive 1999/5/CE.
Niniejszym DENSO CORPORATION oświadcza, że DNMWR004 jest zgodny z zasadniczymi wymogami oraz pozostałymi stosownymi postanowieniami Dyrektywy 1999/5/EC.
DENSO CORPORATION declara que este DNMWR004 está conforme com os requisitos essenciais e outras disposições da Directiva 1999/5/CE.
Hawnhekk, DENSO CORPORATION, jiddikjara li dan DNMWR004 jikkonforma mal-htigijiet essenzjali u ma provvedimenti oħrajn relevanti li hemm fid-Direttiva 1999/5/EC.
Ar šo, DENSO CORPORATION, deklarē, ka DNMWR004 atbilst Direktīvas 1999/5/EK būtiskajām prasībām un citiem ar to saistītajiem noteikumiem.
Šiuo DENSO CORPORATION deklaruoja, kad šis DNMWR004 atitinka esminius reikalavimus ir kitas 1999/5/EB Direktyvos nuostatas.

 CAUTION**■ Before using dynamic radar cruise control**

Do not overly rely on vehicle-to-vehicle distance control.

Be aware of the set speed. If automatic deceleration/acceleration is not appropriate, adjust the vehicle speed, as well as the distance between your vehicle and vehicles ahead by applying the brakes etc.

■ Cautions regarding the driving assist systems

Observe the following precautions.

Failure to do so may cause an accident resulting in death or serious injury.

● Assisting the driver to measure following distance

The dynamic radar cruise control is only intended to help the driver in determining the following distance between the driver's own vehicle and a designated vehicle traveling ahead. It is not a mechanism that allows careless or inattentive driving, and it is not a system that can assist the driver in low-visibility conditions. It is still necessary for driver to pay close attention to the vehicle's surroundings.

● Assisting the driver to judge proper following distance

The dynamic radar cruise control determines whether the following distance between the driver's own vehicle and a designated vehicle traveling ahead is appropriate or not. It is not capable of making any other type of judgement. Therefore, it is absolutely necessary for the driver to remain vigilant and to determine whether or not there is a possibility of danger in any given situation.

● Assisting the driver to operate the vehicle

The dynamic radar cruise control has no capability to prevent or avoid a collision with a vehicle traveling ahead. Therefore, if there is ever any danger, the driver must take immediate and direct control of the vehicle and act appropriately in order to ensure the safety of all involved.

■ To avoid inadvertent cruise control activation

Switch the cruise control off using the "ON-OFF" button when not in use.

 CAUTION**■ Situations unsuitable for dynamic radar cruise control**

Do not use dynamic radar cruise control in any of the following situations.

Doing so may result in inappropriate speed control and could cause an accident resulting in death or serious injury.

- In heavy traffic
- On roads with sharp bends
- On winding roads
- On slippery roads, such as those covered with rain, ice or snow
- On steep downhills, or where there are sudden changes between sharp up and down gradients
Vehicle speed may exceed the set speed when driving down a steep hill.
- At entrances to expressways
- When weather conditions are bad enough that they may prevent the sensors from functioning correctly (fog, snow, sandstorm, heavy rain, etc.)
- When an approach warning buzzer is heard often
- When your vehicle is towing a trailer (with towing hitch) or during emergency towing
- In traffic conditions where the vehicle is repeatedly sped up and slowed down at frequent intervals

■ When the sensor may not be correctly detecting the vehicle ahead

Apply the brakes as necessary when any of the following types of vehicles are in front of you.

As the sensor may not be able to correctly detect these types of vehicles, the approach warning (→P. 303) will not be activated, and a fatal or serious accident may result.

- Vehicles that cut in suddenly
- Vehicles traveling at low speeds
- Vehicles that are not moving
- Vehicles with small rear ends (trailers with no load on board etc.)
- Motorcycles traveling in the same lane

 CAUTION**■ Conditions under which the vehicle-to-vehicle distance control may not function correctly**

Apply the brakes as necessary in the following conditions as the radar sensor may not be able to correctly detect vehicles ahead, and a fatal or serious accident may result:

- When water or snow thrown up by the surrounding vehicles hinders the functioning of the sensor
- When your vehicle is pointing upwards (caused by a heavy load in the luggage compartment etc.)
- When the road curves or when the lanes are narrow
- When steering wheel operation or your position in the lane is unstable
- When the vehicle ahead of you decelerates suddenly
- Excessive exhaust gas (black smoke) is coming from the vehicle ahead or other vehicles around you, obscuring your front view
- The rear section of the vehicle ahead is extremely dirty
- The vehicle ahead has higher ground clearance

■ To ensure the sensor functions correctly

Do not do the following to the sensor or grille as doing so may cause the sensor not to function correctly and could result in an accident:

- Sticking or attaching anything to them
- Leaving them dirty
- Disassembling or subjecting them to strong shocks
- Modifying or painting them
- Replacing them with non-genuine parts

 CAUTION**■ Handling the radar sensor**

Observe the following to ensure the cruise control system can function effectively.

Otherwise, the system may not function correctly and could result in an accident.

- Keep the sensor and grille cover clean at all times.
Clean the sensor and grille cover with a soft cloth so you do not mark or damage them.
- Do not subject the sensor or surrounding area to a strong impact.
If the sensor moves even slightly off position, the system may malfunction.
If the sensor or surrounding area is subject to a strong impact, always have the area inspected and adjusted by any authorized Toyota dealer or repairer, or another duly qualified and equipped professional.
- Do not disassemble the sensor.
- Do not attach accessories or stickers to the sensor, grille cover or surrounding area.
- Do not modify or paint the sensor and grille cover.
- Do not replace them with non-genuine parts.

Toyota parking assist-sensor*

The distance from your vehicle to nearby obstacles when parallel parking or maneuvering into a garage is measured by the sensors and communicated via the indicator or displays, and a buzzer. Always check the surrounding area when using this system.

Types of sensors

- ① Front corner sensors (if equipped)
- ② Front center sensors (if equipped)
- ③ Rear corner sensors
- ④ Rear center sensors

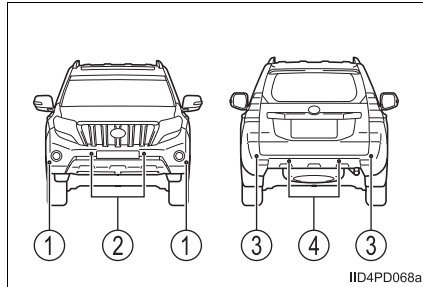

Toyota parking assist-sensor switch

- ▶ 4 sensor type

Turns Toyota parking assist-sensor on/off

When on, the indicator light come on and the buzzer sounds to inform the driver that the system is operational.

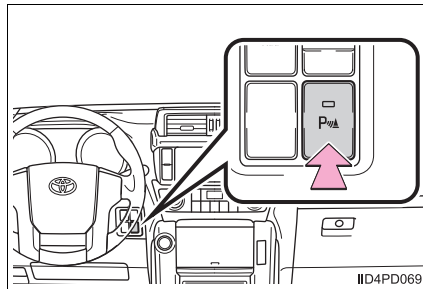

*: If equipped

▶ 8 sensor type

- 1 Display the Toyota parking assist-sensor on/off screen.

- ① Press the menu switch.
The multi-information display will change modes to electronic features control mode.
- ② Press the “ENTER” switch upwards or downwards until the Toyota parking assist-sensor mark appears in the multi-information display.

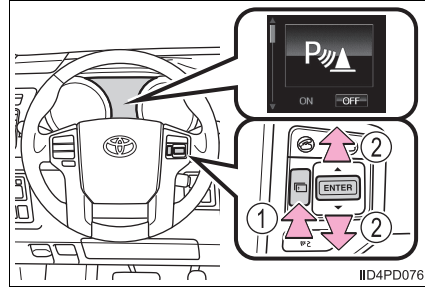

- 2 Press the “ENTER” switch to change to “ON”.

The Toyota parking assist-sensor indicator will be displayed.

Each pressing of the switch turns the Toyota parking assist-sensor on and off.

When on, the buzzer sounds to inform the driver that the system is operational.

Press the menu switch to change to the normal display.

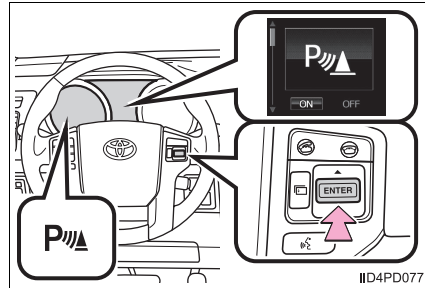

Display

When the sensors detect an obstacle, the following indicator or displays inform the driver of the position and distance to the obstacle.

► Toyota parking assist-sensor indicator (if equipped)

- ① Vehicle indicator
- ② Rear corner indicator
- ③ Rear center indicator

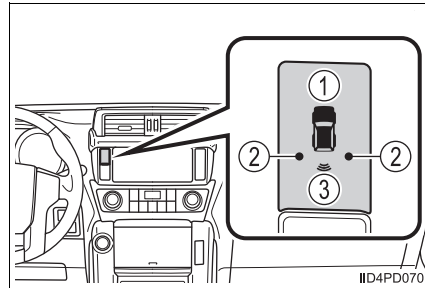

► Multi-information display (if equipped)

- ① Front corner sensor operation (if equipped)
- ② Front center sensor operation (if equipped)
- ③ Rear corner sensor operation
- ④ Rear center sensor operation

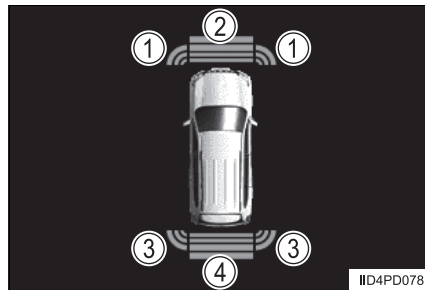

► Navigation system or multimedia system screen (if equipped)

① Toyota parking assist-sensor display

When the rear view monitor system*, Toyota parking assist monitor* or Multi-terrain Monitor* is not displayed.

A graphic is automatically displayed when an obstacle is detected. The screen can be set so that the graphic is not displayed. (→P. 319)

② Insert display

When the rear view monitor system*, Toyota parking assist monitor* or Multi-terrain Monitor* is displayed.

A simplified image is displayed on the upper corner of the screen when an obstacle is detected.



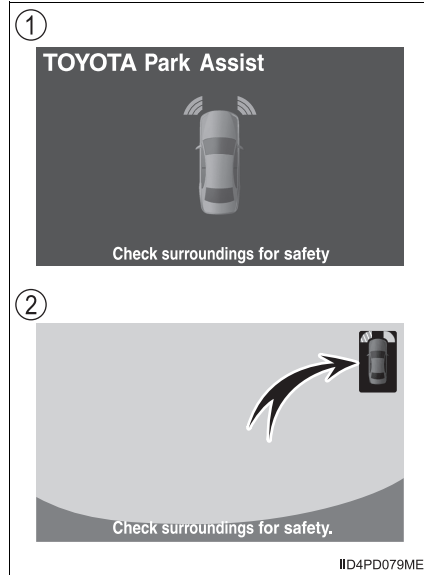





*: If equipped

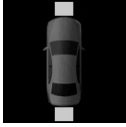

Sensor detection display, obstacle distance

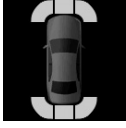
■ **Distance display**

Sensors that detect an obstacle will illuminate continuously or blink.

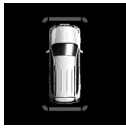
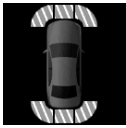
Indicator	Display	Insert display	Approximate distance to obstacle	
			Front corner sensor / front center sensor*1	Rear corner sensor / rear center sensor
 (blinking slowly)	 (continuous)	 (blinking slowly)	Front center sensor: 100 cm (3.3 ft.) to 60 cm (2.0 ft.)	Rear center sensor: 150 cm (4.9 ft.) to 65 cm (2.1 ft.)
 (blinking)	 (continuous)	 (blinking)	Front corner sensor: 50 cm (1.6 ft.) to 40 cm (1.3 ft.) Front center sensor: 60 cm (2.0 ft.) to 45 cm (1.5 ft.)	Rear corner sensor: 55 cm (1.8 ft.) to 37.5 cm (1.2 ft.) Rear center sensor: 65 cm (2.1 ft.) to 50 cm (1.6 ft.)
 (blinking rapidly)	 (continuous)	 (blinking rapidly)	Front corner sensor: 40 cm (1.3 ft.) to 30 cm (1.0 ft.) Front center sensor: 45 cm (1.5 ft.) to 30 cm (1.0 ft.)	Rear corner sensor: 37.5 cm (1.2 ft.) to 25 cm (0.8 ft.) Rear center sensor: 50 cm (1.6 ft.) to 40 cm (1.3 ft.)
 (continuous)	 (blinking*2 or continuous*3)	 (continuous)	Less than 30 cm (1.0 ft.)	Rear corner sensor: Less than 25 cm (0.8 ft.) Rear center sensor: Less than 40 cm (1.3 ft.)

*1: Except for 4 sensor type

*2: Multi-information display

*3: Navigation system or multimedia system screen

■ Buzzer operation and distance to an obstacle

A buzzer sounds when the sensors are operating.

- The buzzer sounds faster as the vehicle approaches an obstacle. When the vehicle comes within the following distance of the obstacle, the buzzer sounds continuously.
 - Front corner sensors: Approximately 30 cm (1.0 ft.)
 - Front center sensors: Approximately 30 cm (1.0 ft.)
 - Rear corner sensors: Approximately 25 cm (0.8 ft.)
 - Rear center sensors: Approximately 40 cm (1.3 ft.)
- When 2 or more obstacles are detected simultaneously, the buzzer system responds to the nearest obstacle. If one or both come within the above distances, the beep will repeat a long tone, followed by fast beeps.

Detection range of the sensors

- ① Approximately 100 cm (3.3 ft.)
- ② Approximately 150 cm (4.9 ft.)
- ③ Approximately 50 cm (1.6 ft.)
- ④ Approximately 55 cm (1.8 ft.)

The diagram shows the detection range of the sensors. Note that the sensors may not be able to detect obstacles that are extremely close to the vehicle.

The range of the sensors may change depending on the shape of the object etc.

*: If equipped

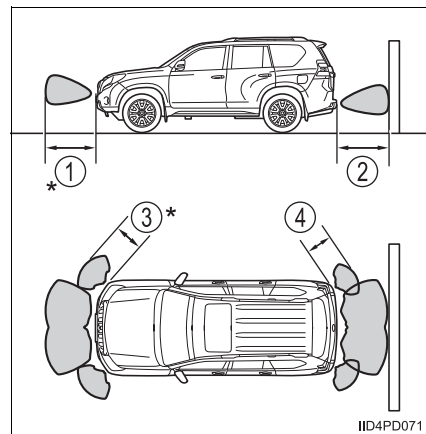

Setting up Toyota parking assist-sensor (vehicles with a navigation system or a multimedia system)

You can change the buzzer sound volume and the screen operating conditions.

- 1 Press the "SETUP" button.
- 2 Select "Vehicle" on the screen.
- 3 Select the desired item.
 - The buzzer sound volume can be adjusted.
 - On or off can be selected for Toyota parking assist-sensor display.
 - Front or rear center sensors display and tone indication can be set.

■ The Toyota parking assist-sensor can be operated when

- Front corner sensors:
 - The engine switch is in the "ON" position (vehicles without a smart entry & start system) or the engine switch is turned to IGNITION ON mode (vehicles with a smart entry & start system).
 - The shift lever is in a position other than P.
 - The vehicle speed is less than approximately 10 km/h (6 mph).
(At any speed when the shift lever is in R)
- Front center sensors:
 - The engine switch is in the "ON" position (vehicles without a smart entry & start system) or the engine switch is turned to IGNITION ON mode (vehicles with a smart entry & start system).
 - The shift lever is in a position other than P or R.
 - The vehicle speed is less than about 10 km/h (6 mph).
- Rear corner and rear center sensors:
 - The engine switch is in the "ON" position (vehicles without a smart entry & start system) or the engine switch is turned to IGNITION ON mode (vehicles with a smart entry & start system).
 - The shift lever is in R.

■ Toyota parking assist-sensor display



When an obstacle is detected while the Toyota parking assist monitor or Multi-terrain Monitor is in use, the warning indicator will appear in the top right or left of the screen even if the display setting has been set to off.

■ Sensor detection information

- The sensor's detection areas are limited to the areas around the vehicle's bumper.
- Certain vehicle conditions and the surrounding environment may affect the ability of a sensor to correctly detect an obstacle. Particular instances where this may occur are listed below.
 - There is dirt, snow or ice on the sensor. (Wiping the sensors will resolve this problem.)
 - The sensor is frozen. (Thawing the area will resolve this problem.)
 - The sensor is covered in any way.
 - The vehicle is leaning considerably to one side.
 - On an extremely bumpy road, on an incline, on gravel, or on grass.
 - The vicinity of the vehicle is noisy due to vehicle horns, motorcycle engines, air brakes of large vehicles, or other loud noises producing ultrasonic waves.
 - There is another vehicle equipped with parking assist sensors in the vicinity.
 - The sensor is coated with a sheet of spray or heavy rain.
 - The vehicle is equipped with a fender pole or wireless antenna.
 - Towing eyelets are installed.
 - The bumper or sensor receives a strong impact.
 - The vehicle is approaching a tall or curved curb.
 - In harsh sunlight or intense cold weather.
 - The area directly under the bumpers is not detected.
 - If obstacles draw too close to the sensor.
 - A non-genuine Toyota suspension (lowered suspension etc.) is installed.
 - People may not be detected if they are wearing certain types of clothing.In addition to the examples above, there are instances in which, because of their shape, signs and other objects may be judged by a sensor to be closer than they are.
- The shape of the obstacle may prevent a sensor from detecting it. Pay particular attention to the following obstacles:
 - Wires, fences, ropes, etc.
 - Cotton, snow and other materials that absorb sound waves
 - Sharply-angled objects
 - Low obstacles
 - Tall obstacles with upper sections projecting outwards in the direction of your vehicle

- The following situations may occur during use:
 - Depending on the shape of the obstacle and other factors, the detection distance may shorten, or detection may be impossible.
 - Obstacles may not be detected if they are too close to the sensor.
 - There will be a short delay between obstacle detection and indicator. Even at slow speeds, there is a possibility that the obstacle will come within the sensor's detection areas before the indicator comes on and the warning beep sounds.
 - Thin posts or objects lower than the sensor may not be detected when approached, even if they have been detected once.
 - It might be difficult to hear beeps due to the volume of audio system or air flow noise of the air conditioning system.

■ When the system malfunctions

- ▶ Vehicles with a Toyota parking assist-sensor indicator
 - If the vehicle indicator remains on while the rear corner and rear center indicators flash and the malfunction beep sounds for approximately 8 seconds, have the vehicle inspected by any authorized Toyota dealer or repairer, or another duly qualified and equipped professional.
 - If the vehicle indicator and the rear corner and rear center indicators flash and the malfunction beep sounds for approximately 8 seconds, clean the sensors with soft cloth.
- ▶ Vehicles with a navigation system or a multimedia system
 - If  displays on the screen, have the vehicle inspected by your Toyota dealer.
 - If  displays on the screen, clean the sensors with soft cloth.
- ▶ Vehicles with a multi-information display

A message is displayed on the multi-information display: →P. 606

■ Customization

Setting of buzzer volume can be changed.
(Customizable features →P. 705)

CAUTION

■ When using the Toyota parking assist-sensor

Observe the following precautions.

Failing to do so may result in the vehicle being unable to be driven safely and possibly cause an accident.

- Do not use the sensor at speeds in excess of 10 km/h (6 mph).
- The sensors' detection areas and reaction times are limited. When moving, check the areas surrounding the vehicle (especially the sides of the vehicle) for safety, and drive slowly, using the brake to control the vehicle's speed.
- Do not install accessories within the sensors' detection areas.

 NOTICE**■ When using Toyota parking assist-sensor**

In the following situations, the system may not function correctly due to a sensor malfunction etc. Have the vehicle checked by any authorized Toyota dealer or repairer, or another duly qualified and equipped professional.

- A beep does not sound when you turn the Toyota parking assist-sensor on.
- If the area around a sensor collides with something, or is subjected to strong impact.
- If the bumper collides with something.
- ▶ With a Toyota parking assist-sensor indicator
 - The rear corner and center indicators flash, and a beep sounds when no obstacles are detected.
 - If the rear corner and center indicators show continuously without a beep.
 - If a indicator error occurs, first check the sensor.
If the error occurs even when there is no ice, snow or mud on the sensor, it is likely that the sensor is malfunctioning.
- ▶ Without a Toyota parking assist-sensor indicator
 - The Toyota parking assist-sensor operation display flashes, and a beep sounds when no obstacles are detected.
 - If the display shows continuously without a beep.
 - If a display error occurs, first check the sensor.
If the error occurs even when there is no ice, snow or mud on the sensor, it is likely that the sensor is malfunctioning.

■ Notes when washing the vehicle

Do not apply intensive bursts of water or steam to the sensor area. Doing so may result in the sensor malfunctioning.

Rear view monitor system*

The rear view monitor system assists the driver by displaying guide lines and an image of the view behind the vehicle while backing up, for example while parking.

The screen illustrations used in this text are intended as examples, and may differ from the image that is actually displayed on the screen.

The rear view monitor system will activate when the shift lever is in R.

The rear view monitor system will be deactivated when the shift lever is in any position other than R.

When the shift lever is shifted to the R position and any mode button (such as "MENU") is pressed, the rear view monitor system is canceled, and the screen is switched to the mode of the button that was pressed.

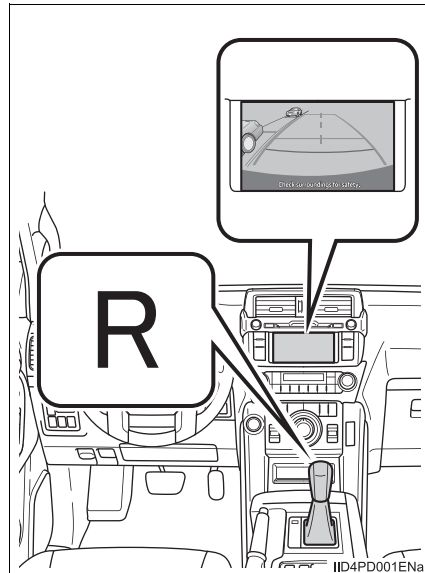

*: If equipped

Using the rear view monitor system

■ Screen description

▶ Vehicles without a smart entry & start system

The rear view monitor system screen will be displayed if the shift lever is shifted to R while the engine switch is in the “ON” position.

▶ Vehicles with a smart entry & start system

The rear view monitor system screen will be displayed if the shift lever is shifted to R while the engine switch is in IGNITION ON mode.

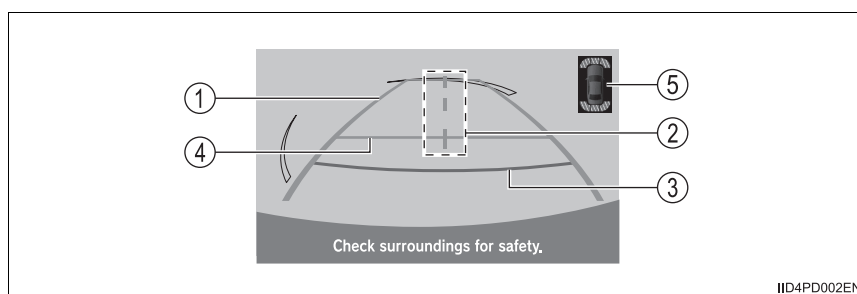

① Vehicle width extension guide line

The line indicates a guide path when the vehicle is being backed straight up.

The displayed width is wider than the actual vehicle width.

② Vehicle center guide line

These lines indicate the estimated vehicle center on the ground.

③ Distance guide line (red)

The line shows distance behind the vehicle, a point approximately 0.5 m (1.5 ft.) from the edge of the bumper.

④ Distance guide line (blue)

The line shows distance behind the vehicle, a point approximately 1 m (3 ft.) from the edge of the bumper.

⑤ Toyota parking assist-sensor display (if equipped)

If an obstacle is detected while the Toyota parking assist-sensor is on, a display is shown at the top right corner of the screen.

Rear view monitor system precautions

■ Area displayed on screen

The rear view monitor system displays an image of the view from the bumper of the rear area of the vehicle.

The image on the rear view monitor system screen can be adjusted, refer to the “Navigation system owner’s manual”.

- The area displayed on the screen may vary according to vehicle orientation conditions.
- Objects which are close to either corner of the bumper or under the bumper cannot be displayed.
- The camera uses a special lens. The distance of the image that appears on the screen differs from the actual distance.
- Items which are located higher than the camera may not be displayed on the monitor.
- If your vehicle is equipped with a backlit license plate, it may interfere with the display.

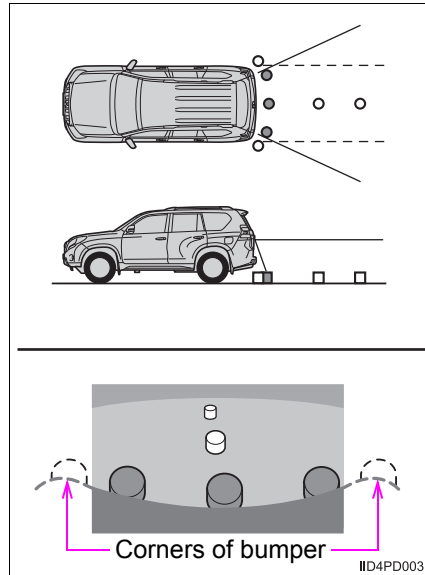

■ Rear view monitor system camera

- ▶ Vehicles with back door mounted spare tire

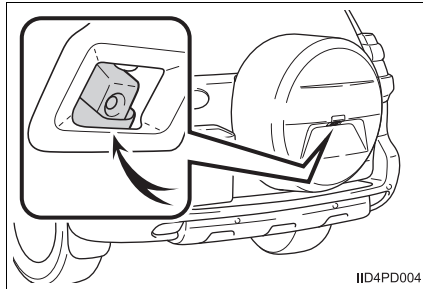

- ▶ Vehicles with under floor mounted spare tire

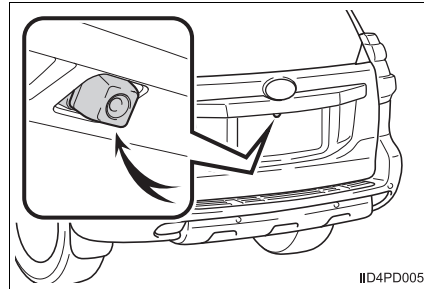

● Using the camera

If the camera lens becomes dirty, it cannot transmit a clear image. If water droplets, snow or mud adhere to the lens, rinse with water and wipe with a soft cloth. If the lens is extremely dirty, wash it with a mild cleanser and rinse.

■ Differences between the screen and the actual road

The distance guide lines and the vehicle width extension guide lines may not actually be parallel with the dividing lines of the parking space, even when they appear to be so. Be sure to check visually.

The distances between the vehicle width extension guide lines and the left and right dividing lines of the parking space may not be equal, even when they appear to be so. Be sure to check visually.

The distance guide lines give a distance guide for flat road surfaces. In any of the following situations, there is a margin of error between the fixation guide lines on the screen and the actual distance/course on the road.

- When the ground behind the vehicle slopes up sharply

The distance guide lines will appear to be closer to the vehicle than the actual distance. Because of this, objects will appear to be farther away than they actually are. In the same way, there will be a margin of error between the guide lines and the actual distance/course on the road.

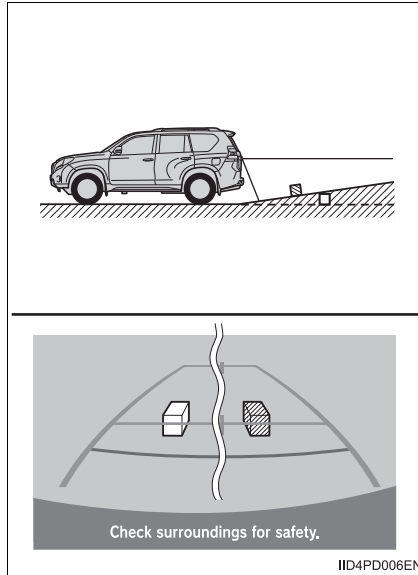

- When the ground behind the vehicle slopes down sharply

The distance guide lines will appear to be further from the vehicle than the actual distance. Because of this, objects will appear to be closer than they actually are. In the same way, there will be a margin of error between the guide lines and the actual distance/course on the road.

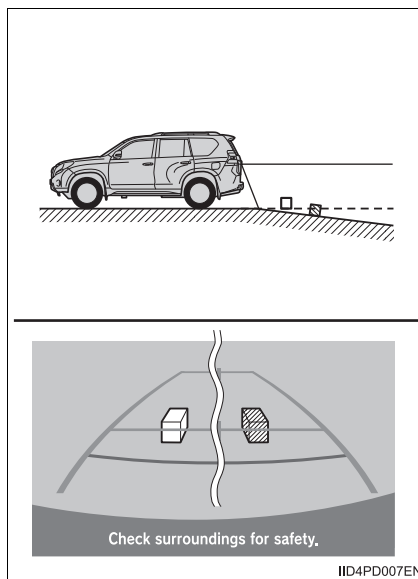

- When any part of the vehicle sags

When any part of the vehicle sags due to the number of passengers or the distribution of the load, there is a margin of error between the fixation guide lines on the screen and the actual distance/course on the road.

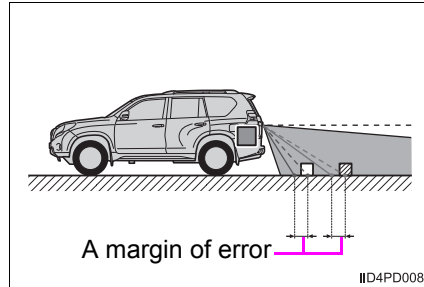

- When approaching three-dimensional objects

The distance guide lines are displayed according to flat surfaced objects (such as the road). It is not possible to determine the position of three-dimensional objects (such as vehicles) using the distance guide lines. When approaching a three-dimensional object that extends outward (such as the flatbed of a truck), be careful of the following.

- Vehicle width extension guide lines

Visually check the surroundings and the area behind the vehicle. In the case shown in the illustration, the truck appears to be outside of the vehicle width extension guide lines and the vehicle does not look as if it hits the truck. However, the rear body of the truck may actually cross over the vehicle width extension guide lines. In reality if you back up as guided by the vehicle width extension guide lines, the vehicle may hit the truck.

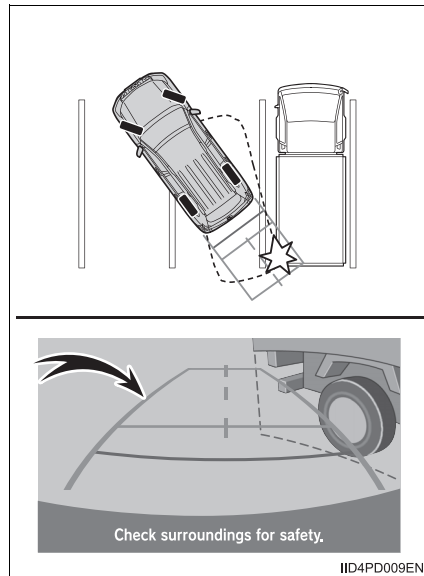

● Distance guide lines

Visually check the surroundings and the area behind the vehicle. On the screen, it appears that a truck is parking at point ②. However, in reality if you back up to point ①, you will hit the truck. On the screen, it appears that ① is closest and ③ is farthest away. However, in reality, the distance to ① and ③ is the same, and ② is farther than ① and ③.

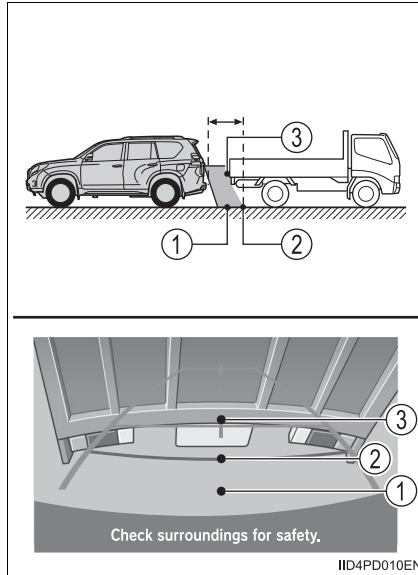

Things you should know

■ If you notice any symptoms

If you notice any of the following symptoms, refer to the likely cause and the solution, and re-check.

If the symptom is not resolved by the solution, have the vehicle inspected by any authorized Toyota dealer or repairer, or another duly qualified and equipped professional.

Likely cause	Solution
<input type="checkbox"/> The image is difficult to see	
<ul style="list-style-type: none"> • The vehicle is in a dark area • The temperature around the lens is either high or low • The outside temperature is low • There are water droplets on the camera • It is raining or humid • Foreign matter (mud etc.) is adhering to the camera • There are scratches on the camera • Sunlight or headlights are shining directly into the camera • The vehicle is under fluorescent lights, sodium lights, mercury lights etc. 	<p>If this happens due to these causes, it does not indicate a malfunction. Back up while visually checking the vehicle's surroundings. (Use the monitor again once conditions have been improved.)</p> <p>The image on the rear view monitor system screen can be adjusted, refer to the "Navigation system owner's manual".</p>
<input type="checkbox"/> The image is blurry	
Dirt or foreign matter (such as water droplets, snow, mud etc.) is adhering to the camera.	Rinse the camera lens with water and wipe it clean with a soft cloth. Wash with a mild soap if the dirt is stubborn.
<input type="checkbox"/> The image is out of alignment	
The camera or surrounding area has received a strong impact.	Have the vehicle inspected by any authorized Toyota dealer or repairer, or another duly qualified and equipped professional.

Likely cause	Solution
<input type="checkbox"/> The fixed guide lines are very far out of alignment	
The camera position is out of alignment.	Have the vehicle inspected by any authorized Toyota dealer or repairer, or another duly qualified and equipped professional.
<ul style="list-style-type: none"> • The vehicle is tilted (there is a heavy load on the vehicle, tire pressure is low due to a tire puncture, etc.) • The vehicle is used on an incline. 	If this happens due to these causes, it does not indicate a malfunction. Back up while visually checking the vehicle's surroundings.

 CAUTION**■ When using the rear view monitor system**

The rear view monitor system is a supplemental device intended to assist the driver when backing up. When backing up, be sure to check visually behind and all around the vehicle before proceeding.

Observe the following precautions to avoid an accident that could result in death or serious injuries.

- Never depend on the rear view monitor system entirely when backing up. The image and the position of the guide lines displayed on the screen may differ from the actual state.
Use caution, just as you would when backing up any vehicle.
- Be sure to back up slowly, depressing the brake pedal to control vehicle speed.
- The instructions given are only guide lines.
When and how much to turn the steering wheel will vary according to traffic conditions, road surface conditions, vehicle condition, etc. when parking. It is necessary to be fully aware of this before using the rear view monitor system.
- When parking, be sure to check that the parking space will accommodate your vehicle before maneuvering into it.
- Do not use the rear view monitor system in the following cases:
 - On icy or slick road surfaces, or in snow
 - When using tire chains
 - When the back door is not closed completely
 - On roads that are not flat or straight, such as curves or slopes.
- In low temperatures, the screen may darken or the image may become faint. The image could distort when the vehicle is moving, or you may become unable to see the image on the screen. Be sure to check direct visually and with the mirrors all around the vehicle before proceeding.
- If the tire sizes are changed, the position of the fixed guide lines displayed on the screen may change.
- The camera uses a special lens. The distances between objects and pedestrians that appear in the image displayed on the screen will differ from the actual distances. (→P. 326)



NOTICE

■ How to use the camera

- The rear view monitor system may not operate properly in the following cases.
 - If the back of the vehicle is hit, the position and mounting angle of the camera may change.
 - As the camera has a water proof construction, do not detach, disassemble or modify it. This may cause incorrect operation.
 - Do not strongly rub the camera lens. If the camera lens is scratched, it cannot transmit a clear image.
 - Do not allow organic solvent, car wax, window cleaner or glass coat to adhere to the camera. If this happens, wipe it off as soon as possible.
 - If the temperature changes rapidly, such as when hot water is poured on the vehicle in cold weather, the system may not operate normally.
 - When washing the vehicle, do not apply intensive bursts of water to the camera or camera area. Doing so may result in the camera malfunctioning.
 - When the camera is used under fluorescent lights, sodium light or mercury light etc., the lights and the illuminated areas may appear to flicker.
- Do not expose the camera to strong impact as this could cause a malfunction. If this happens, have the vehicle inspected by any authorized Toyota dealer or repairer, or another duly qualified and equipped professional as soon as possible.

Toyota parking assist monitor*

The parking assist monitor assists the driver by displaying an image of the view behind the vehicle while backing up, for example while parking.

The parking assist monitor assists with the following 2 backing-up operations:

- Perpendicular parking (parking in a garage, etc.)
- Parallel parking (parking at the side of the road, etc.)

The screen illustrations used in this text are intended as examples, and may differ from the image that is actually displayed on the screen.

Parking assist monitor will activate when the shift lever is in R.

The parking assist monitor system will be deactivated when the shift lever is in any position other than R.

When the shift lever is shifted to the R position and any mode button (such as "MENU") is pressed, the parking assist monitor is canceled, and the screen is switched to the mode of the button that was pressed.

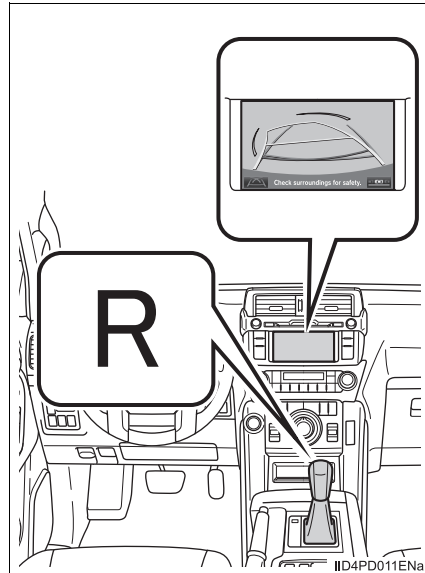

4

Driving

*: If equipped

Using the Toyota parking assist monitor

■ Screen display

- ▶ Vehicles without a smart entry & start system

The rear view monitor system screen will be displayed if the shift lever is shifted to R while the engine switch is in the "ON" position.

- ▶ Vehicles with a smart entry & start system

The parking assist monitor screen will be displayed if the shift lever is shifted to R while the engine switch is in IGNITION ON mode.

The parking assist monitor displays the last-used parking mode first.

- ▶ Perpendicular parking

- ▶ Parallel parking

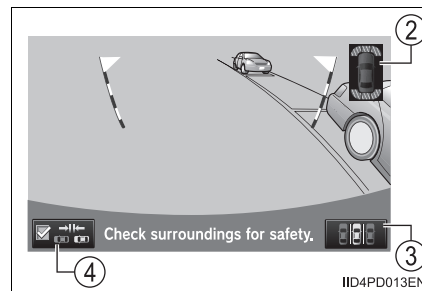
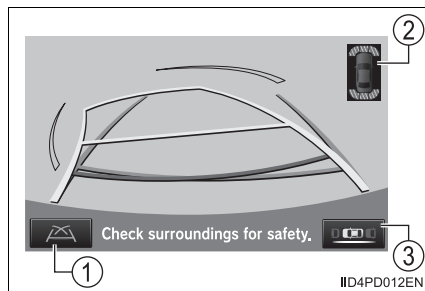

- ① Display mode switch screen button
Switches the display mode. (→P. 336)
- ② Toyota parking assist-sensor display
If an obstacle is detected while the Toyota parking assist-sensor is on, a display is shown in the top right corner of the screen.
- ③ Parking mode switch screen button
Switches the parking mode (between perpendicular parking and parallel parking assist screens)
- ④ Narrow mode screen on-off button
Switch the narrow mode on and off. (→P. 349)

■ Using the system when perpendicular parking

Use any of the following modes when perpendicular parking (for example, when parking in a garage).

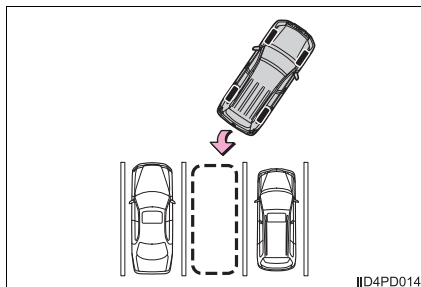

Each time you select the display mode switch screen button, the display mode switches in the following order:

Estimated course line display mode



Parking assist guide line display mode



Distance guide line display mode

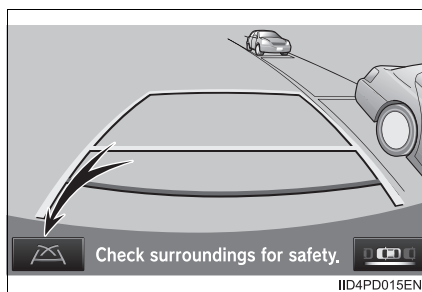

- Estimated course line display mode (→P. 339)

Estimated course lines are displayed which move in accordance with the operation of the steering wheel.

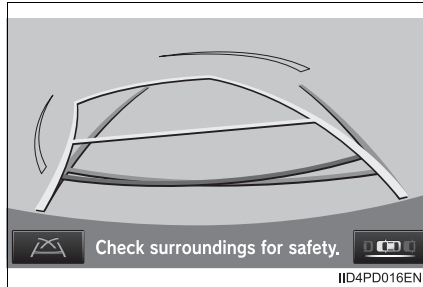

- Parking assist guide line display mode (→P. 341)

The steering wheel return points (parking assist guide lines) are displayed.

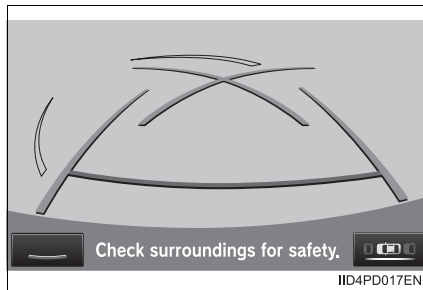

- Distance guide line display mode

Distance guide lines only are displayed.

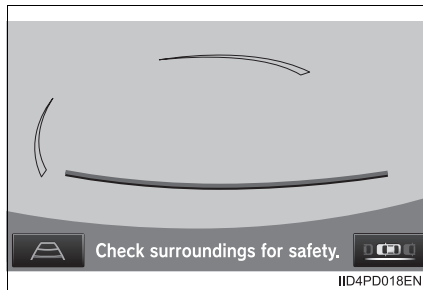

■ Using the system when parallel parking

Screen display and beep sounds provide an estimation of the point at which you should turn the steering wheel when parallel parking. If the position the vehicle is to be parked in is narrower than usual, narrow mode can be used.

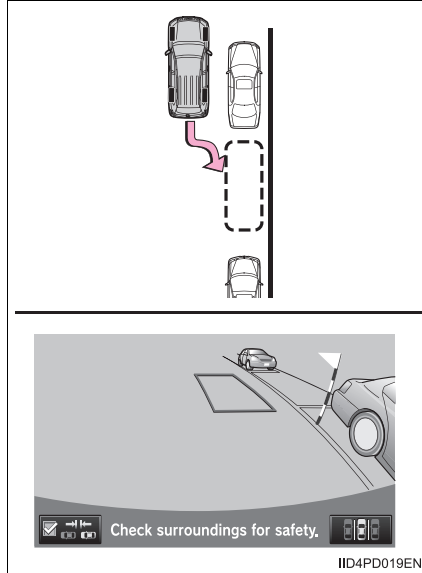

Each time you select the narrow mode screen on-off button, the narrow mode and the normal mode are switched.

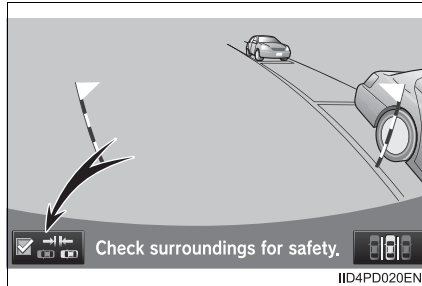

■ Switching the parking mode screen

Each time you select the parking mode switch screen button, the perpendicular parking mode and parallel parking mode are switched.

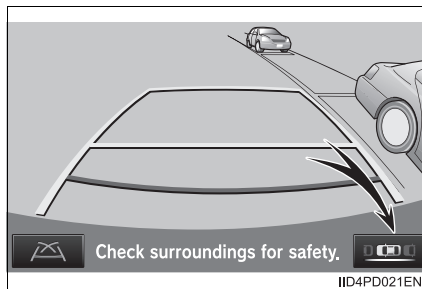

Perpendicular parking (estimated course line display mode)

■ **Screen description**

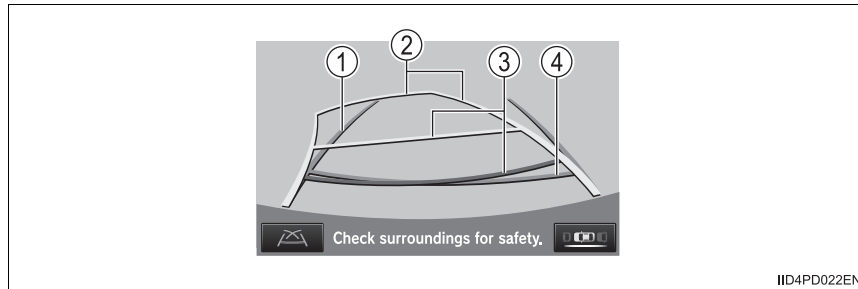

- ① **Vehicle width extension guide line**
 The line indicates a guide path when the vehicle is being backed straight up.
 The displayed width is wider than the actual vehicle width.
 The line aligns with the estimated course lines when the steering wheel is straight.
- ② **Estimated course lines**
 The lines show an estimated course when the steering wheel is turned.
- ③ **Distance guide line**
 The line moves, together with the estimated course lines, in sync with the steering wheel. The line shows points approximately 0.5 m (1.5 ft.) (red) and approximately 1 m (3 ft.) (yellow) from the center of the edge of the bumper.
- ④ **Distance guide line**
 The line shows distance behind the vehicle, a point approximately 0.5 m (1.5 ft.) (blue) from the edge of the bumper.

■ Parking operation

When parking in a space which is in the reverse direction to the space described in the procedure below, the steering directions will be reversed.

1 Shift the shift lever to the R position.

2 Turn the steering wheel so that the estimated course lines are within the parking space, and back up slowly.

① Parking space

② Estimated course lines

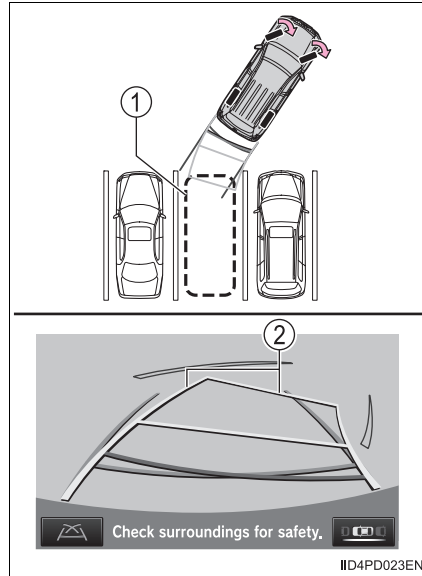

3 When the rear position of the vehicle has entered the parking space, turn the steering wheel so that the vehicle width extension guide lines are within the left and right dividing lines of the parking space.

③ Vehicle width extension guide line

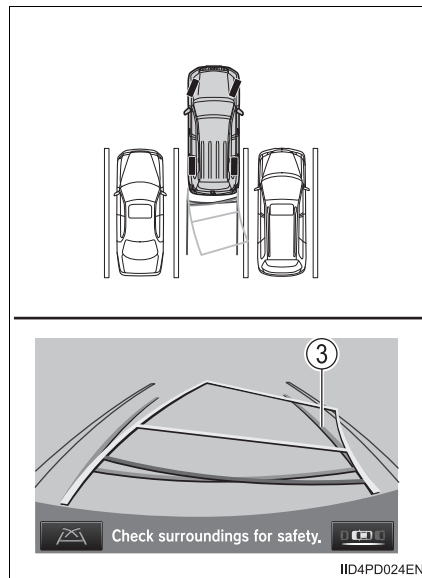

- 4 Once the vehicle width extension guide lines and the parking space lines are parallel, straighten the steering wheel and back up slowly until the vehicle has completely entered the parking space.
- 5 Stop the vehicle in an appropriate place, and finish parking.

Perpendicular parking (parking assist guide line display mode)

■ Screen description

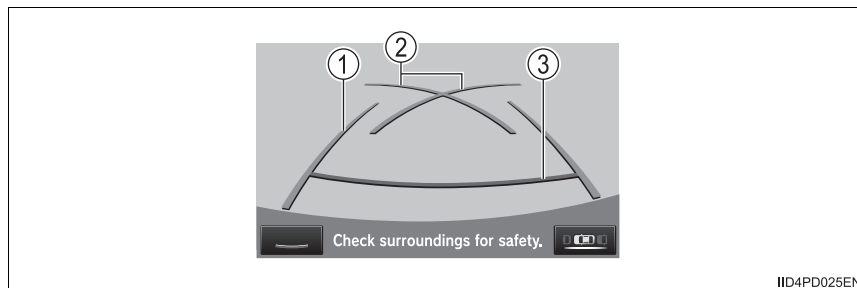

- ① Vehicle width extension guide lines
These lines indicate a guide path when the vehicle is being backed straight up. The displayed width is wider than the actual vehicle width.
- ② Parking assist guide lines
These lines indicate the path of the smallest turn possible behind the vehicle.
These lines also indicate the approximate position of the steering wheel when parking.
- ③ Distance guide line
This line (red) indicates points approximately 0.5 m (1.5 ft.) behind the rear bumper of your vehicle.

■ Parking operation

When parking in a space which is in the reverse direction to the space described in the procedure below, the steering directions will be reversed.

1 Shift the shift lever to the R position.

2 Back up until the parking assist guide line meets the edge of the left-hand dividing line of the parking space.

① Parking assist guide line

② Parking space dividing line

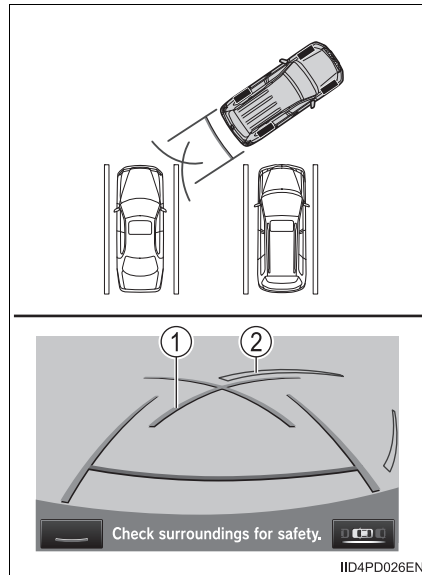

3 Turn the steering wheel all the way to the right, and back up slowly.

4 Once the vehicle is parallel with the parking space, straighten the steering wheel and back up slowly until the vehicle has completely entered the parking space.

5 Stop the vehicle in an appropriate place, and finish parking.

Parallel parking

■ Vehicle movement procedure

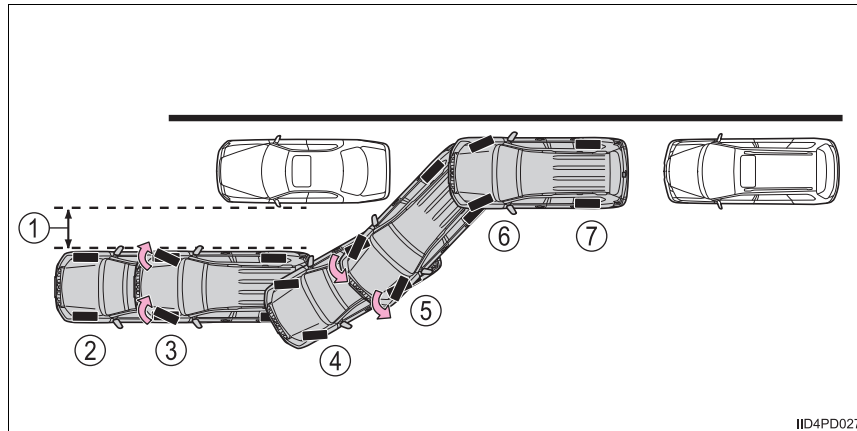

- ① Approx. 1 m (3 ft.)
- ② Keeping parallel with the road, stop the vehicle leaving a gap of approximately 1 m (3 ft.) between your vehicle and the parked vehicle (Step 1 in "Parking operation").
- ③ Back up until the black and yellow vertical pole just overlaps the rear end of the parked vehicle. Then stop the vehicle (Step 4 in "Parking operation").
Leaving the vehicle stopped, move the steering wheel until the blue outline meets the desired parking space, and back up while keeping the steering wheel in that position (Step 5 in "Parking operation").
- ④ A curved blue line is displayed. Keep the steering wheel in the same position and back up until the curved blue line meets the right corner of the parking space (Step 7 in "Parking operation").
- ⑤ When it meets the right corner of the parking space, turn the steering wheel in the opposite direction as far as it will go (Step 8 in "Parking operation").
- ⑥ Keeping the steering wheel in that position, check your surroundings visually and using mirrors, and back up using the distance guide lines etc. as a reference (Step 9 in "Parking operation").
- ⑦ When the vehicle is approximately in the desired parking location, parallel parking assist is complete (Step 10 in "Parking operation").

■ Parking operation

The following example describes the procedure for pulling into a parking space on the right. For pulling into a parking space on the left, substitute left for right and vice versa in all steps.

- 1 Stop the vehicle in the position as described below, and straighten the steering wheel.

- ① Roughly half a vehicle's length
- ② Desired parking space
- ③ Approx. 1 m (3 ft.)
- ④ Parked vehicle
- ⑤ Your vehicle

A position in which you are parallel with the road (or the side of the road), and in which there is approximately 1 m (3 ft.) of space between your vehicle and the parked vehicle

A position in which you are half a vehicle's length ahead of the parked vehicle

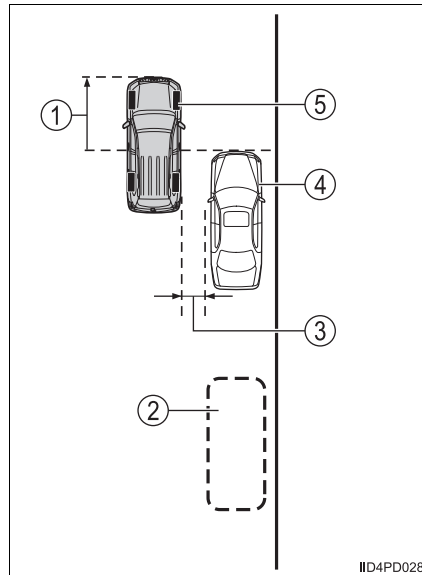

- 2 Shift the shift lever to the R position.
- 3 Make sure the monitor displays the part behind the rear tires of the parked vehicle, and select . If the area is not displayed, move the vehicle to forward.

- 4 With the steering wheel straight, back up slowly to a position at which the black and yellow vertical pole just overlaps the rear end of the parked vehicle. Then stop the vehicle.

- ① Black and yellow vertical pole
- ② Back the vehicle up to here

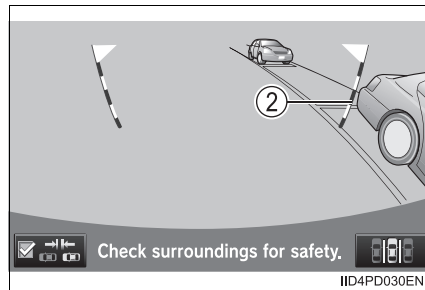
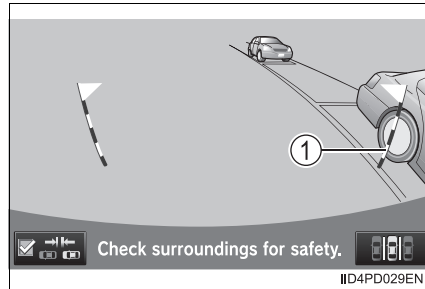

- 5 Turn the steering wheel with the vehicle stopped until the blue outline meets the desired parking space.

- ① Blue outline
- ② Black and yellow vertical pole
- ③ Extended line

If the extended line from the blue outline is displayed, the parallel parking assist is operational.

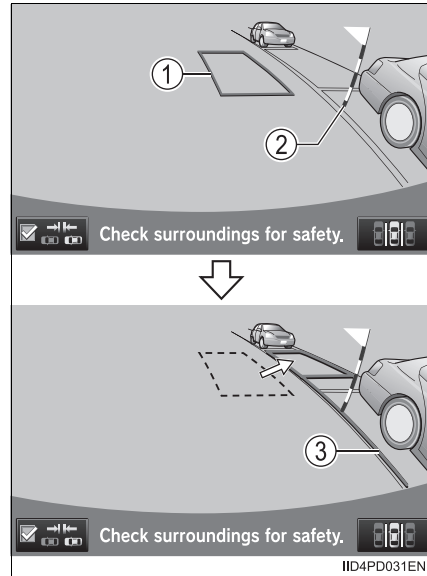

- ④ Turn the steering wheel right
- ⑤ Black and yellow vertical pole
- ⑥ Blue outline

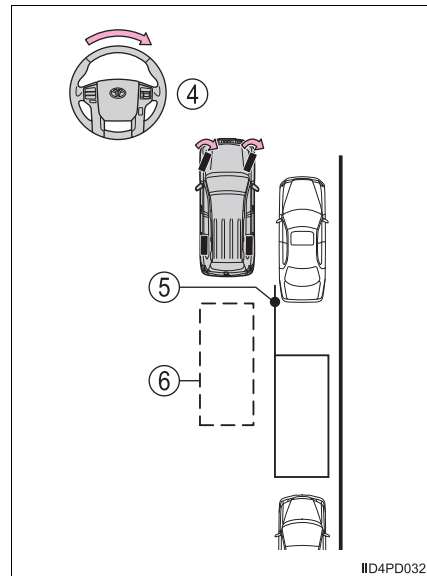

- 6 Keep the steering wheel in its current position and backing up.

When backing up, be careful not to hit any obstacles with the right front corner of your vehicle. Back the vehicle up slowly.

- 7 A curved blue line will appear on the screen. Keep the steering wheel in its current position and back up slowly. Stop when the curved blue line meets the corner of the desired parking space.

- ① Curved blue line

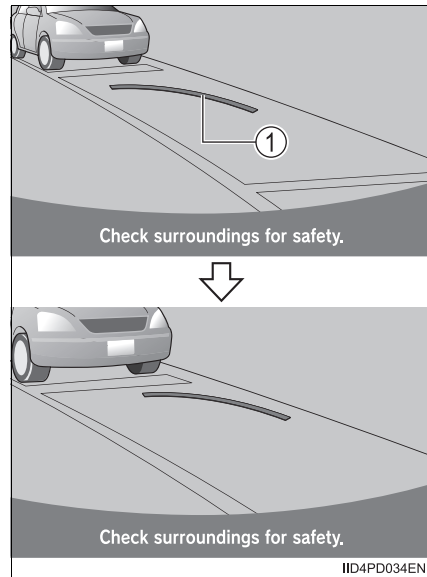

- ② Back up keeping the steering wheel in its current position
③ Curved blue line
④ Curved blue line meets the corner here

If you back up too quickly, you may lose synchronization with the parallel parking assist.

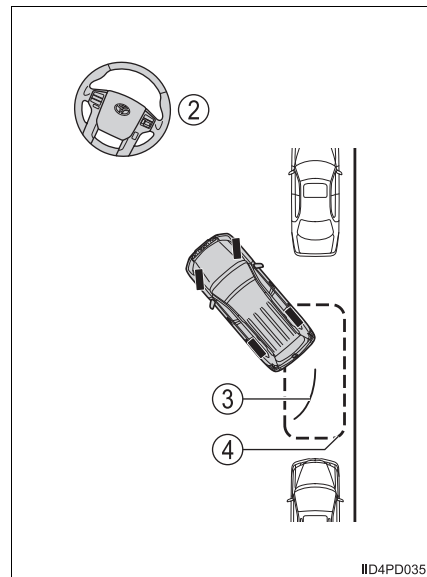

- 8 Leaving the vehicle stopped, turn the steering wheel all the way to the left.

Be sure to turn the steering wheel only when the vehicle is stopped.

- 9 When the screen changes, keep the steering wheel in its current position and back up.

When backing up, be careful not to hit any obstacles with the right front corner of your vehicle. Back the vehicle up slowly.

- 10 When the vehicle is parallel with the road or the shoulder, straighten the steering wheel.

Check your surroundings visually and with the mirrors, then back up using the distance guide lines as a reference, and stop.

When the vehicle is approximately in the desired parking location, the parallel parking assist is complete.

- Parallel parking assist mode information
 - There is a possibility that parallel parking guidance may not be given when backing up at a very slow speed.
 - If the back door is opened during parallel parking guidance, the parallel parking assist will be interrupted and canceled. Stop the vehicle, shift the shift lever out of the R position, and restart the operation from the step 1.

- Canceling parallel parking assist

Select .

- Vehicles with Toyota parking assist-sensor

If Toyota parking assist-sensor detects an object while you attempt to park in a parking space on the left, the black and yellow vertical pole could be obscured by Toyota parking assist-sensor display. In this event, turn Toyota parking assist-sensor switch off (→P. 313), and operate the vehicle while checking the safety of the surrounding area direct visually and with mirror. After the operation, turn the switch on.

- If the message “Steering wheel turned too far, please return.” is displayed

The steering wheel has been turned too far, and the system cannot function. Return the steering wheel to its original position.

If the message is displayed before the outline is positioned over the desired parking space, it is likely that the vehicle is too far away from the shoulder. Check that there is a gap of approximately 1 m (3 ft.) between your vehicle and the parked vehicle.

■ **Narrow mode**

If the position the vehicle is to be parked in is narrower than usual, narrow mode can be used.



① Normal mode

② Narrow mode

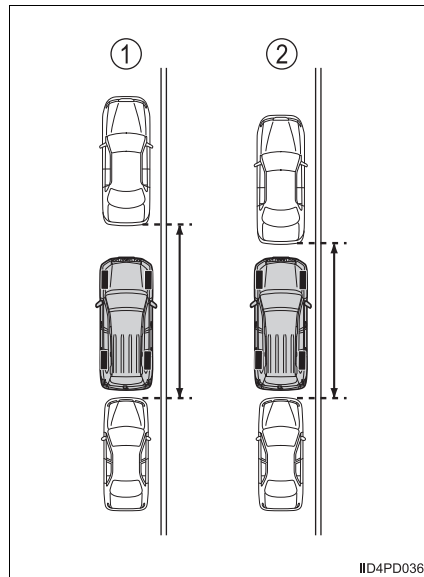

The engine switch is turned off when the parking assist monitor is canceled with narrow mode, the caution screen is displayed first when the parallel parking assist is selected next time.



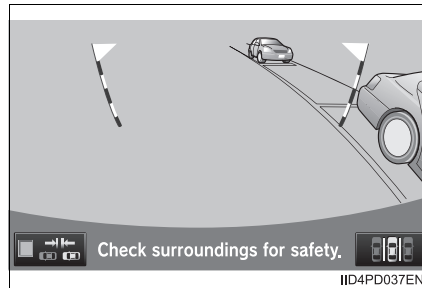

- Operating narrow mode

- 1 Select  /  while in parallel parking assist mode.



- 2 Confirm the warning on the caution screen. If you agree, select "I Agree". To cancel narrow mode, select .
- 3 When the system is switched to narrow mode, the indicator on  /  will be turned on.

Select  /  again to switch the system to the normal mode.

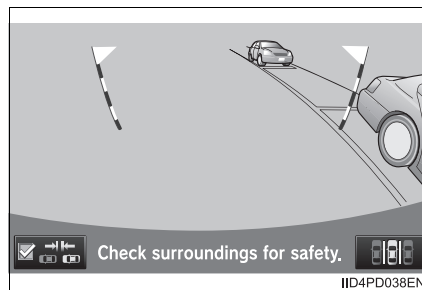

Toyota parking assist monitor precautions

■ Area displayed on screen

The parking assist monitor displays an image of the view from the bumper of the rear area of the vehicle.

The image on the rear view monitor system screen can be adjusted, refer to the “Navigation system owner’s manual”.

- The area displayed on the screen may vary according to vehicle orientation conditions.
- Objects which are close to either corner of the bumper or under the bumper cannot be seen on the screen.
- The camera uses a special lens. The distance of the image that appears on the screen differs from the actual distance.
- Items which are located higher than the camera may not be displayed on the monitor.
- If your vehicle is equipped with a backlit license plate, it may interfere with the display.

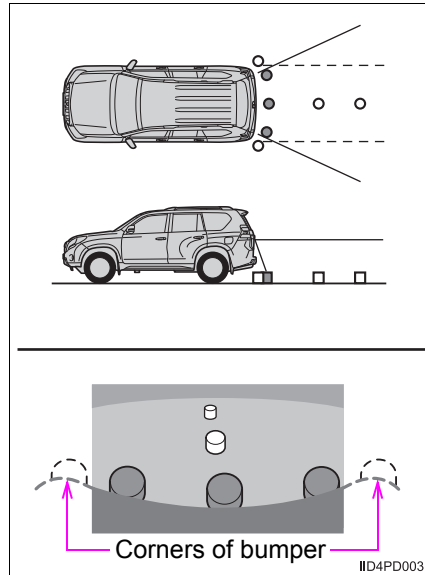

■ Toyota parking assist monitor camera

- ▶ Vehicles with back door mounted spare tire

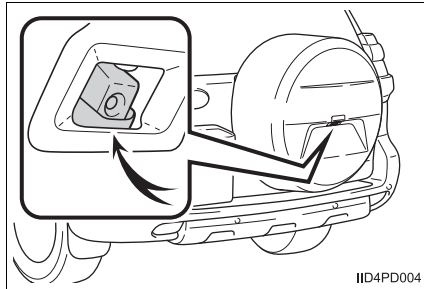

- ▶ Vehicles with under floor mounted spare tire

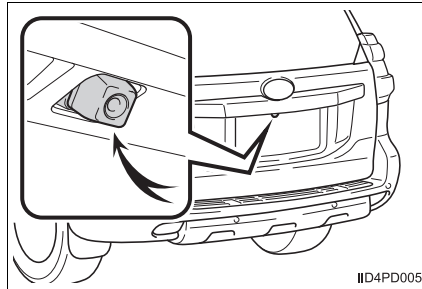

● Using the camera

If the camera lens becomes dirty, it cannot transmit a clear image. If water droplets, snow or mud adhere to the lens, rinse with water and wipe with a soft cloth. If the lens is extremely dirty, wash it with a mild cleanser and rinse.

■ Differences between the screen and the actual road

The distance guide lines and the vehicle width extension guide lines may not actually be parallel with the dividing lines of the parking space, even when they appear to be so. Be sure to check visually.

The distances between the vehicle width extension guide lines and the left and right dividing lines of the parking space may not be equal, even when they appear to be so. Be sure to check visually.

The distance guide lines give a distance guide for flat road surfaces. In any of the following situations, there is a margin of error between the guide lines on the screen and the actual distance/course on the road.

- When the ground behind the vehicle slopes up sharply

The distance guide lines will appear to be closer to the vehicle than the actual distance. Because of this, objects will appear to be farther away than they actually are. In the same way, there will be a margin of error between the guidelines and the actual distance/course on the road.

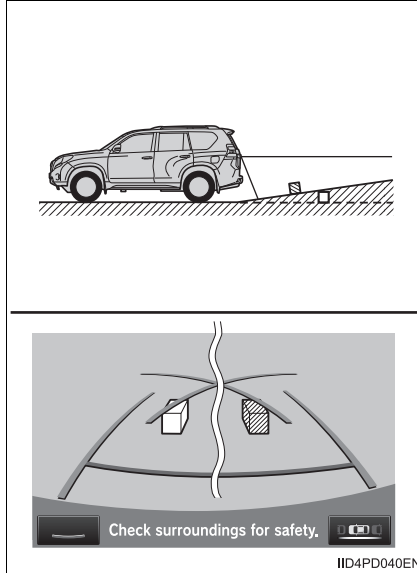

- When the ground behind the vehicle slopes down sharply

The distance guide lines will appear to be further from the vehicle than the actual distance. Because of this, objects will appear to be closer than they actually are. In the same way, there will be a margin of error between the guidelines and the actual distance/course on the road.

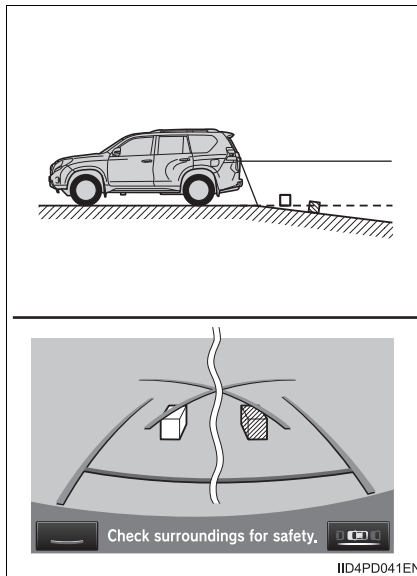

- When any part of the vehicle sags

When any part of the vehicle sags due to the number of passengers or the distribution of the load, there is a margin of error between the guide lines on the screen and the actual distance/course on the road.

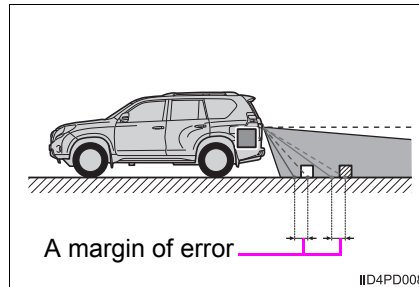

- When approaching three-dimensional objects

The estimated course lines target a flat surfaced objects (such as the road). It is not possible to determine the position of three-dimensional objects (such as vehicles) using the estimated course lines and distance guide lines. When approaching a three-dimensional object that extends outward (such as the flatbed of a truck), be careful of the following.

- Estimated course lines

Visually check the surroundings and the area behind the vehicle. In the case shown in the illustration, the truck appears to be outside of the estimated course lines and the vehicle does not look as if it hits the truck. However, the rear body of the truck may actually cross over the estimated course lines. In reality if you back up as guided by the estimated course lines, the vehicle may hit the truck.

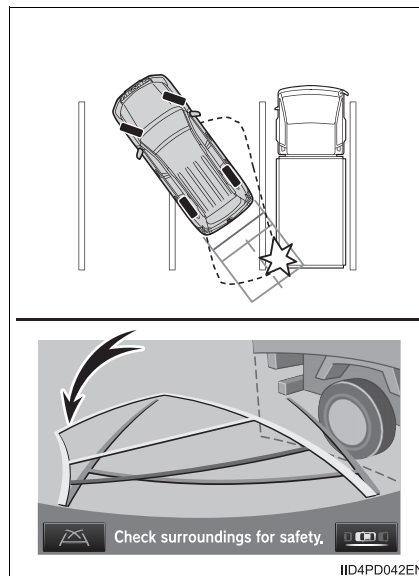

● Distance guidelines

Visually check the surroundings and the area behind the vehicle. On the screen, it appears that a truck is parking at point ②. However, in reality if you back up to point ①, you will hit the truck. On the screen, it appears that ① is closest and ③ is farthest away. However, in reality, the distance to ① and ③ is the same and ② is farther than ① and ③.

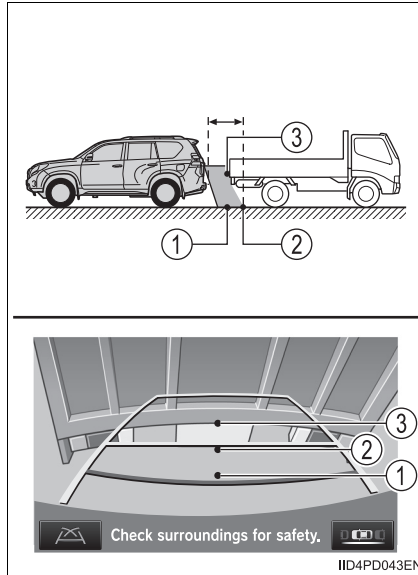

Things you should know

■ If you notice any symptoms

If you notice any of the following symptoms, refer to the likely cause and the solution, and re-check.

If the symptom is not resolved by the solution, have the vehicle inspected by any authorized Toyota dealer or repairer, or another duly qualified and equipped professional.

Likely cause	Solution
<input type="checkbox"/> The image is difficult to see	
<ul style="list-style-type: none"> • The vehicle is in a dark area • The temperature around the lens is either high or low • The outside temperature is low • There are water droplets on the camera • It is raining or humid • Foreign matter (mud etc.) is adhering to the camera • There are scratches on the camera • Sunlight or headlights are shining directly into the camera • The vehicle is under fluorescent lights, sodium lights, mercury lights etc. 	<p>If this happens due to these causes, it does not indicate a malfunction. Back up while visually checking the vehicle's surroundings. (Use the monitor again once conditions have been improved.)</p> <p>The image on the rear view monitor system screen can be adjusted, refer to the "Navigation system owner's manual".</p>
<input type="checkbox"/> The image is blurry	
Dirt or foreign matter (such as water droplets, snow, mud etc.) is adhering to the camera.	Rinse the camera lens with water and wipe it clean with a soft cloth. Wash with a mild soap if the dirt is stubborn.
<input type="checkbox"/> The image is out of alignment	
The camera or surrounding area has received a strong impact.	Have the vehicle inspected by any authorized Toyota dealer or repairer, or another duly qualified and equipped professional.

Likely cause	Solution
<input type="checkbox"/> The guide lines are very far out of alignment	
The camera position is out of alignment.	Have the vehicle inspected by any authorized Toyota dealer or repairer, or another duly qualified and equipped professional.
<ul style="list-style-type: none"> • The vehicle is tilted (there is a heavy load on the vehicle, tire pressure is low due to a tire puncture, etc.) • The vehicle is used on an incline. 	If this happens due to these causes, it does not indicate a malfunction. Back up while visually checking the vehicle's surroundings.
<input type="checkbox"/> The estimated course lines move even though the steering wheel is straight	
There is a malfunction in the signals being output by the steering sensor.	Have the vehicle inspected by any authorized Toyota dealer or repairer, or another duly qualified and equipped professional.
<input type="checkbox"/> Guide lines are not displayed	
The back door is open.	Close the back door. If this does not resolve the symptom, have the vehicle inspected by any authorized Toyota dealer or repairer, or another duly qualified and equipped professional.
<input type="checkbox"/> "System is initializing." is displayed	
<ul style="list-style-type: none"> • The battery has been reinstalled. • The steering wheel has been moved while the battery was being reinstalled. • Battery power is low. • The steering sensor has been reinstalled. • There is a malfunction in the signals being output by the steering sensor. 	<p>Stop the vehicle, and turn the steering wheel as far as it will go to the left and right. (Selecting "?" on the screen displays the operating procedure above.)</p> <p>If this does not resolve the symptom, have the vehicle inspected by any authorized Toyota dealer or repairer, or another duly qualified and equipped professional.</p> <ul style="list-style-type: none"> • On the system initialization screen, touch the "?" button to display the operating procedure.

 CAUTION**■ When using the Toyota parking assist monitor system**

The parking assist monitor is a supplemental device intended to assist the driver when backing up. When backing up, be sure to check visually behind and all around the vehicle before proceeding.

Observe the following precautions to avoid an accident that could result in death or serious injuries.

- Never depend on the parking assist monitor entirely when backing up. The image and the position of the guide lines displayed on the screen may differ from the actual state.
Use caution, just as you would when backing up any vehicle.
- Be sure to back up slowly, depressing the brake pedal to control vehicle speed.
- If you seem likely to hit nearby vehicles, obstacles, people or mount the shoulder, depress the brake pedal to stop the vehicle, then disable the assist system by select  on the screen to cancel the system.
- The instructions given are only guidelines.
When and how much to turn the steering wheel will vary according to traffic conditions, road surface conditions, vehicle condition, etc. when parking. It is necessary to be fully aware of this before using the parking assist system.
- When parking, be sure to check that the parking space will accommodate your vehicle before maneuvering into it.
- Do not use the parking assist monitor in the following cases:
 - On icy or slick road surfaces, or in snow
 - When using tire chains
 - When the back door is not closed completely
 - On roads that are not flat or straight, such as curves or slopes.
- In low temperatures, the screen may darken or the image may become faint. The image could distort when the vehicle is moving, or you may become unable to see the image on the screen. Be sure to check direct visually and with the mirrors all around the vehicle before proceeding.

 CAUTION

- If the tire sizes are changed, the position of the guide lines displayed on the screen may change.
- The camera uses a special lens. The distances between objects and pedestrians that appear in the image displayed on the screen will differ from the actual distances. (→P. 352)

■ **When using the perpendicular parking assist screen**

Estimated course line display mode: If the steering wheel is straight and the vehicle width extension guide lines and the estimated course lines are not in alignment, have the vehicle inspected by any authorized Toyota dealer or repairer, or another duly qualified and equipped professional.

■ **When using the parallel parking assist screen**

- Do not use the system if the display is incorrect due to an uneven (curvy/hilly) road or a non-straight road.
- Make sure to operate the steering wheel only when the vehicle is stopped.
- Be sure to check that there are no obstacles inside the blue outline. If there are any obstacles inside the blue outline, do not use the parallel parking assist.
- When positioning the blue outline over the parking space, be sure to position it so that the extended blue line may not cross the tire of the vehicle parked in front of the empty space.
- If the extended line of the blue outline may be crossing the parked vehicle, your vehicle is too close. Check that there is a gap of approximately 1 m (3 ft.) between your vehicle and the parked vehicle.

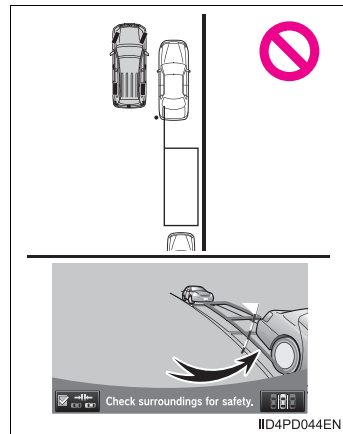



NOTICE

■ How to use the camera

- The parking assist monitor may not operate properly in the following cases.
 - If the back of the vehicle is hit, the position and mounting angle of the camera may change.
 - As the camera has a water proof construction, do not detach, disassemble or modify it. This may cause incorrect operation.
 - Do not strongly rub the camera lens. If the camera lens is scratched, it cannot transmit a clear image.
 - Do not allow organic solvent, car wax, window cleaner or glass coat to adhere to the camera. If this happens, wipe it off as soon as possible.
 - If the temperature changes rapidly, such as when hot water is poured on the vehicle in cold weather, the system may not operate normally.
 - When washing the vehicle, do not apply intensive bursts of water to the camera or camera area. Doing so may result in the camera malfunctioning.
 - When the camera is used under fluorescent lights, sodium light or mercury light etc., the lights and the illuminated areas may appear to flicker.
- Do not expose the camera to strong impact as this could cause a malfunction. If this happens, have the vehicle inspected by any authorized Toyota dealer or repairer, or another duly qualified and equipped professional as soon as possible.

Driving assist systems

To help enhance driving safety and performance, the following systems operate automatically in response to various driving situations. Be aware, however, that these systems are supplementary and should not be relied upon too heavily when operating the vehicle.

◆ ABS (Anti-lock Brake System)

Helps to prevent wheel lock when the brakes are applied suddenly, or if the brakes are applied while driving on a slippery road surface

◆ Multi Terrain ABS (Anti-lock Brake System) (vehicles with a Multi-terrain Select system)

→Refer to the “Off-road Driving Owner’s Manual”

◆ Brake assist

Generates an increased level of braking force after the brake pedal is depressed when the system detects a panic stop situation

◆ VSC (Vehicle Stability Control)

Helps the driver to control skidding when swerving suddenly or turning on slippery road surfaces

◆ TRC (Traction Control) for 2TR-FE engines and H4 position on 1GR-FE and 1KD-FTV engines

Helps to maintain drive power and prevent the 4 wheels from spinning when starting the vehicle or accelerating on slippery roads

◆ Active TRC (Traction Control) for L4 position on 1GR-FE and 1KD-FTV engines*

→Refer to the “Off-road Driving Owner’s Manual”

◆ Hill-start assist control (if equipped)

→Refer to the “Off-road Driving Owner’s Manual”

◆ KDSS (Kinetic Dynamic Suspension System) (if equipped)

→Refer to the “Off-road Driving Owner’s Manual”

◆ PCS (Pre-Crash Safety system) (if equipped)

→P. 379

◆ Emergency brake signal

When the brakes are applied suddenly, the stop lights automatically flash to alert the vehicle behind.

◆ Trailer Sway Control (if equipped)

Helps the driver to control trailer sway by selectively applying brake pressure for individual wheels and reducing engine torque when trailer sway is detected.

Trailer Sway Control is part of the VSC system and will not operate if VSC turned off or experiences a malfunction.

*: The function only works in vehicles with Multi-terrain Select when Multi terrain Select is switched on

When the TRC/VSC/Trailer Sway Control systems are operating

If the vehicle is in danger of slipping or if any of the drive wheels spins, the slip indicator flashes to indicate that the TRC/VSC/Trailer Sway Control systems are operating.

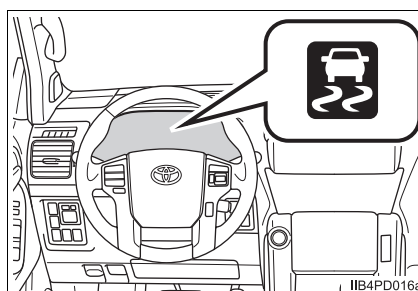

Disabling the TRC/VSC/Trailer Sway Control systems

If the vehicle gets stuck in fresh snow or mud, the TRC/VSC/Trailer Sway Control systems may reduce power from the engine to the wheels. You may need to turn the system off to enable you to rock the vehicle in order to free it.

■ **Turning off TRC system only**

To turn the TRC system off, quickly press and release the switch.

The “TRC OFF” indicator light will come on.

Press the switch again to turn the system back on.

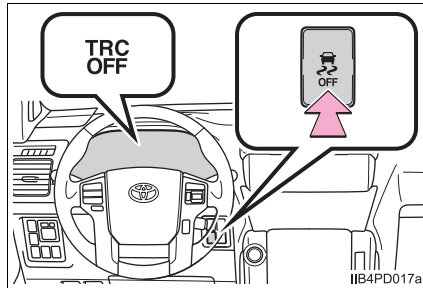

■ **Turning off both TRC and VSC/Trailer Sway Control systems**

To turn the TRC and VSC/Trailer Sway Control systems off, press and hold the switch for 3 seconds and more while the vehicle is stopped.

The VSC OFF indicator light will come on and the “TRC OFF” indicator light will come on.

Press the switch again to turn the system back on.

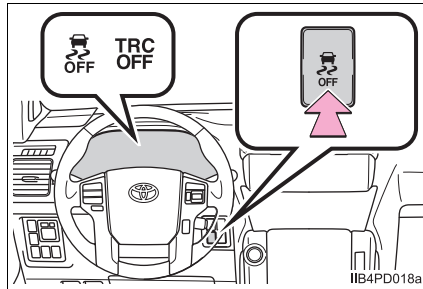

■ Sounds and vibrations caused by the ABS, brake assist, TRC and VSC/Trailer Sway Control systems

- A sound may be heard from the engine compartment when the engine is started or just after the vehicle begins to move. This sound does not indicate that a malfunction has occurred in any of these systems.
- Any of the following conditions may occur when the above systems are operating. None of these indicates that a malfunction has occurred.
 - Vibrations may be felt through the vehicle body and steering.
 - A motor sound may be heard after the vehicle comes to a stop.
 - The brake pedal may pulsate slightly after the ABS is activated.
 - The brake pedal may move down slightly after the ABS is activated.

■ Reactivation of the TRC/VSC/Trailer Sway Control systems after turning off the engine

Turning off the engine after turning off the TRC/VSC/Trailer Sway Control systems will automatically re-enabled them.

■ Reactivation of the TRC system linked to vehicle speed

When only the TRC system is turned off, the TRC system will turn on when vehicle speed increases. However, when both TRC and VSC/Trailer Sway Control systems are turned off, the systems will not turn on even when vehicle speed increases.

■ When the brake system operates continuously

The brake actuator may overheat. In this case, the TRC (vehicles other than 2TR-FE engines) will stop operating, a buzzer will sound and the "TRC OFF" indicator will come on. Refrain from using the system until the "TRC OFF" indicator turns off. (There is no problem with continuing normal driving.)

■ Operating conditions of emergency brake signal

When the following three conditions are met, the emergency brake signal will operate:

- The emergency flashers are off.
- Actual vehicle speed is over 55 km/h (35 mph).
- The brake pedal is depressed in a manner that cause the system to judge from the vehicle deceleration that this is a sudden braking operation.

■ Automatic system cancelation of emergency brake signal

The emergency brake signal will turn off in any of the following situations:

- The emergency flashers are turned on.
- The brake pedal is released.
- The system judges from the vehicle deceleration that is not a sudden braking operation.

■ If the slip indicator comes on...

It may indicate a malfunction in the TRC or VSC/Trailer Sway Control system. Consult any authorized Toyota dealer or repairer, or another duly qualified and equipped professional.

 CAUTION**■ The ABS does not operate effectively when**

- The limits of tire gripping performance have been exceeded (such as excessively worn tires on a snow covered road).
- The vehicle hydroplanes while driving at high speed on the wet or slick road.

■ Stopping distance when the ABS is operating may exceed that of normal conditions

The ABS is not designed to shorten the vehicle's stopping distance. Always maintain a safe distance from the vehicle in front of you, especially in the following situations:

- When driving on dirt, gravel or snow-covered roads
- When driving with tire chains
- When driving over bumps in the road
- When driving over roads with potholes or roads with uneven surfaces

■ TRC may not operate effectively when

Directional control and power may not be achievable while driving on slippery road surfaces, even if the TRC system is operating. Do not drive the vehicle in conditions where stability and power may be lost.

■ When the VSC/Trailer Sway Control is activated

The slip indicator light flashes. Always drive carefully. Reckless driving may cause an accident. Exercise particular care when the indicator light flashes.

■ When the TRC/VSC/Trailer Sway Control systems are turned off

Be especially careful and drive at a speed appropriate to the road conditions. As these are the systems to help enhance vehicle stability and driving force, do not turn the TRC/VSC/Trailer Sway Control systems off unless necessary.

 CAUTION**■ Replacing tires**

Make sure that all tires are of the same size, brand, tread pattern and total load capacity. In addition, make sure that the tires are inflated to the recommended tire inflation pressure level.

The ABS, TRC and VSC/Trailer Sway Control will not function correctly if different tires are installed on the vehicle.

Contact any authorized Toyota dealer or repairer, or another duly qualified and equipped professional for further information when replacing tires or wheels.

■ Handling of tires and the suspension

Using tires with any kind of problem or modifying the suspension will affect the driving assist systems, and may cause the system to malfunction.

■ Trailer Sway Control precaution

The Trailer Sway Control system is not able to reduce trailer sway in all situations. Depending on many factors such as the conditions of the vehicle, trailer, road surface, and driving environment, the Trailer Sway Control system may not be effective. Refer to your trailer owner's manual for information on how to tow your trailer properly.

■ If trailer sway occurs

Observe the following precautions.

Failing to do so may cause death or serious injury.

- Firmly grip the steering wheel. Steer straight ahead.
Do not try to control trailer swaying by turning the steering wheel.
- Begin releasing the accelerator pedal immediately but very gradually to reduce speed.
Do not increase speed. Do not apply vehicle brakes.

If you make no extreme correction with the steering or brakes, your vehicle and trailer should stabilize. (→P. 236)

BSM (Blind Spot Monitor)*

Summary of the Blind Spot Monitor

The Blind Spot Monitor is a system that has 2 functions;

- The Blind Spot Monitor function
Assists the driver in making the decision when changing lanes
- The Rear Crossing Traffic Alert function (if equipped)
Assists the driver when backing up

These functions use same sensors.

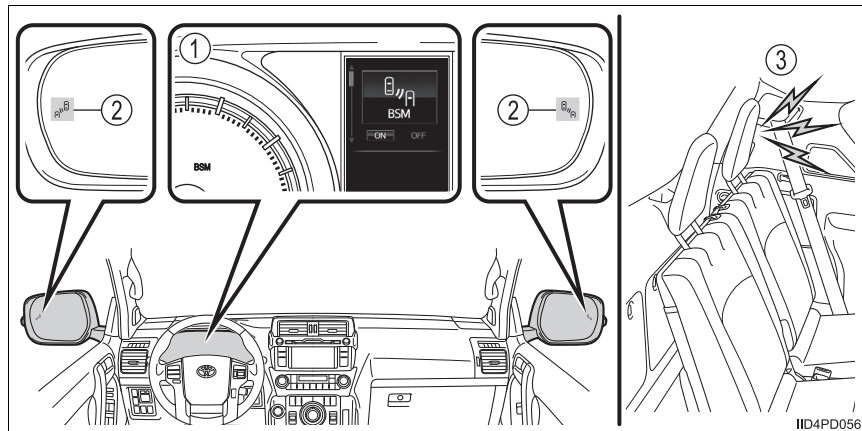

*: If equipped

① The Blind Spot Monitor on/off screen and indicator.

The Blind Spot Monitor system can be turned on/off on the multi-information display. When the system is set to on, the indicator illuminates in the meter. The Blind Spot Monitor function and the Rear Crossing Traffic Alert function are turned on/off simultaneously.

② Outside rear view mirror indicator

Blind Spot Monitor function:

When a vehicle is detected in the blind spot, the outside rear view mirror indicator comes on while the turn signal lever is not operated and the outside rear view mirror indicator flashes while the turn signal lever is operated.

Rear Crossing Traffic Alert function:

When a vehicle approaching from the right or left rear of the vehicle is detected, the outside rear view mirror indicators flash.

③ Rear Crossing Traffic Alert buzzer (Rear Crossing Traffic Alert function only)

When a vehicle approaching from the right or left rear of the vehicle is detected, a buzzer sounds from behind the rear seat.

Turning the Blind Spot Monitor system on

- 1 Display the Blind Spot Monitor on/off screen.

- ① Press the menu switch.
The multi-information display will change modes to electronic features control mode.
- ② Press the “ENTER” switch upwards or downwards until “BSM” appears in the multi-information display.

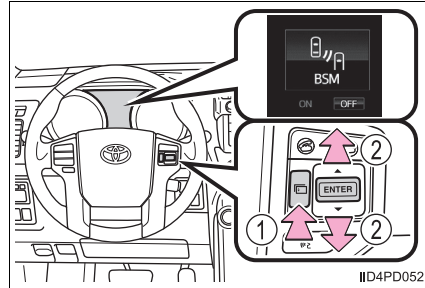

- 2 Press the “ENTER” switch to change to “ON”.
The Blind Spot Monitor indicator will be displayed.

Each pressing of the switch turns the Blind Spot Monitor on and off. When on, the buzzer sounds to inform the driver that the system is operational.

Press the menu switch to change to the normal display.

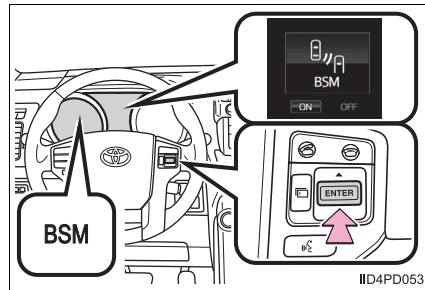

■ The outside rear view mirror indicators visibility

When under strong sunlight, the outside rear view mirror indicator may be difficult to see.

■ Rear Crossing Traffic Alert buzzer hearing

Rear Crossing Traffic Alert function may be difficult to hear over loud noises such as high audio volume.

■ When there is a malfunction in the Blind Spot Monitor

If a system malfunction is detected due to any of the following reasons, warning messages will be displayed: (→P. 609, 610)

- There is a malfunction with the sensors
- The sensors have become dirty
- The outside temperature is extremely high or low
- The sensor voltage has become abnormal

■ Certification for the Blind Spot Monitor

- ▶ For vehicles sold in Russia

type approval number: POCC DE.ML05.H01144



ML05

- ▶ For vehicles sold in Ukraine

type approval number: 1O094.000966-13



155

► For vehicles sold in Europe

CE 0700

The latest “DECLARATION of CONFORMITY” (DoC) is available at the following:

DoC address:

<http://continental.automotive-approvals.de/index.php?produkt=SRR2-A>

CONTINENTAL tímto prohlašuje, že tento SRR2-A je ve shodě se základními požadavky a dalšími příslušnými ustanoveními směrnice 1999/5/ES.
Undertegnede CONTINENTAL erklærer herved, at følgende udstyr SRR2-A overholder de væsentlige krav og øvrige relevante krav i direktiv 1999/5/EF.
Hiermit erkläre CONTINENTAL, dass sich das Gerät SRR2-A in Übereinstimmung mit den grundlegenden Anforderungen und den übrigen einschlägigen Bestimmungen der Richtlinie 1999/5/EG befindet.
Käesolevaga kinnitab CONTINENTAL seadme SRR2-A vastavust direktiivi 1999/5/EÜ põhinõuetele ja nimetatud direktiivist tulenevatele teistele asjakohastele sätetele.
Hereby, CONTINENTAL, declares that this SRR2-A is in compliance with the essential requirements and other relevant provisions of Directive 1999/5/EC.
Por medio de la presente CONTINENTAL declara que el SRR2-A cumple con los requisitos esenciales y cualesquiera otras disposiciones aplicables o exigibles de la Directiva 1999/5/CE.
ΜΕ ΤΗΝ ΠΑΡΟΥΣΑ CONTINENTAL ΔΗΛΩΝΕΙ ΟΤΙ SRR2-A ΣΥΜΜΟΡΦΩΝΕΤΑΙ ΠΡΟΣ ΤΙΣ ΟΥΣΙΩΔΕΙΣ ΑΠΑΙΤΗΣΕΙΣ ΚΑΙ ΤΙΣ ΛΟΙΠΕΣ ΣΧΕΤΙΚΕΣ ΔΙΑΤΑΞΕΙΣ ΤΗΣ ΟΔΗΓΙΑΣ 1999/5/ΕΚ.
Par la présente CONTINENTAL déclare que l'appareil SRR2-A est conforme aux exigences essentielles et aux autres dispositions pertinentes de la directive 1999/5/CE.
Con la presente CONTINENTAL dichiara che questo SRR2-A è conforme ai requisiti essenziali ed alle altre disposizioni pertinenti stabilite dalla direttiva 1999/5/CE.
Ar šo CONTINENTAL deklarē, ka SRR2-A atbilst Direktīvas 1999/5/EK būtiskajām prasībām un citiem ar to saistītajiem noteikumiem.
Šiuo CONTINENTAL deklaruoja, kad šis SRR2-A atitinka esminius reikalavimus ir kitas 1999/5/EB Direktyvos nuostatas.

Hierbij verklaart CONTINENTAL dat het toestel SRR2-A in overeenstemming is met de essentiële eisen en de andere relevante bepalingen van richtlijn 1999/5/EG.
Hawnhekk, CONTINENTAL, jiddikjara li dan SRR2-A jikkonforma mal-htigijiet essenzjali u ma provvedimenti oħrajn relevanti li hemm fid-Dirrettiva 1999/5/EC.
Alulírott, CONTINENTAL nyilatkozom, hogy a SRR2-A megfelel a vonatkozó alapvető követelményeknek és az 1999/5/EC irányelv egyéb előírásainak.
Niniejszym CONTINENTAL oświadcza, że SRR2-A jest zgodny z zasadniczymi wymogami oraz pozostałymi stosownymi postanowieniami Dyrektywy 1999/5/EC.
CONTINENTAL declara que este SRR2-A está conforme com os requisitos essenciais e outras disposições da Directiva 1999/5/CE.
CONTINENTAL izjavlja, da je ta SRR2-A v skladu z bistvenimi zahtevami in ostalimi relevantnimi določili direktive 1999/5/ES.
CONTINENTAL týmto vyhlasuje, že SRR2-A spĺňa základné požiadavky a všetky príslušné ustanovenia Smernice 1999/5/ES.
CONTINENTAL vakuuttaa täten että SRR2-A tyyppinen laite on direktiivin 1999/5/EY oleellisten vaatimusten ja sitä koskevien direktiivin muiden ehtojen mukainen.
Härmed intygar CONTINENTAL att denna SRR2-A står i överensstämmelse med de väsentliga egenskapskrav och övriga relevanta bestämmelser som framgår av direktiv 1999/5/EG.
Hér með lýsir CONTINENTAL yfir því að SRR2-A er í samræmi við grunnkröfur og aðrar kröfur, sem gerðar eru í tilskipun 1999/5/EC.
CONTINENTAL erklærer herved at utstyret SRR2-A er i samsvar med de grunnleggende krav og øvrige relevante krav i direktiv 1999/5/EF.
С настоящето, CONTINENTAL, декларира, че SRR2-A е в съответствие със съществените изисквания и другите приложими разпоредби на Директива 1999/5/EC.
Prin prezenta, CONTINENTAL, declară că aparatul SRR2-A este în conformitate cu cerințele esențiale și cu alte prevederi pertinente ale Directivei 1999/5/CE.
“Ovim , CONTINENTAL, izjavljuje da ovaj SRR2-A je usklađen sa bitnim zahtjevima i drugim relevantnim odredbama Direktive 1999/5/EC.”
Ovim CONTINENTAL, izjavljuje da je SRR2-A u skladu s bitnim zahtjevima i drugim relevantnim odredbama Direktive 1999/5/EC i Pravilnika o RiTT opremi(NN25/2012)

⚠ CAUTION**■ Handling the radar sensor**

One Blind Spot Monitor sensor is installed inside the left and right side of the vehicle rear bumper respectively. Observe the following to ensure the Blind Spot Monitor can function correctly.

- Keep the sensor and its surrounding area on the bumper clean at all times.

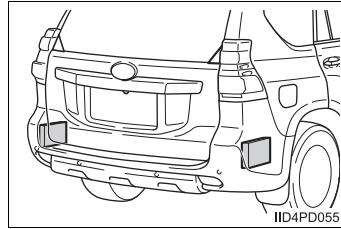

- Do not subject the sensor or surrounding area on the bumper to a strong impact. If the sensor moves even slightly off position, the system may malfunction and vehicles that enter the detection area may not be detected. If the sensor or surrounding area is subject to a strong impact, always have the area inspected by any authorized Toyota dealer or repairer, or another duly qualified and equipped professional.
- Do not disassemble the sensor.
- Do not attach accessories or stickers to the sensor or surrounding area on the bumper.
- Do not modify the sensor or surrounding area on the bumper.
- Do not paint the sensor or surrounding area on the bumper.

The Blind Spot Monitor function

The Blind Spot Monitor function uses radar sensors to detect vehicles that are traveling in an adjacent lane in the area that is not reflected in the outside rear view mirror (the blind spot), and advises the driver of the vehicles existence via the outside rear view mirror indicator.

The Blind Spot Monitor function detection areas

The areas that vehicles can be detected in are outlined below.

The range of the detection area extends to:

- ① Approximately 3.5 m (11.5 ft.) from the side of the vehicle
The first 0.5 m (1.6 ft.) from the side of the vehicle is not in the detection area
- ② Approximately 3 m (9.8 ft.) from the rear bumper
- ③ Approximately 1 m (3.3 ft.) forward of the rear bumper

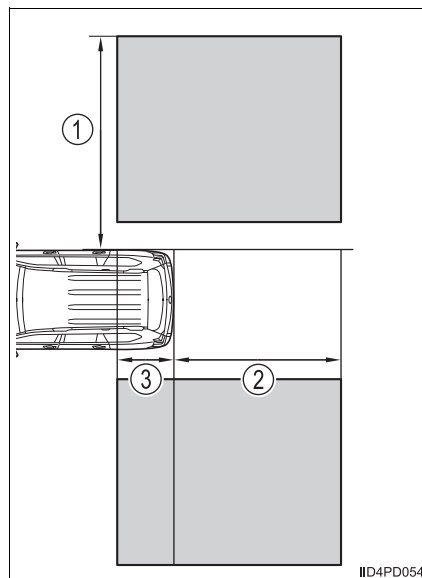

4

Driving

⚠ CAUTION

■ Cautions regarding the use of the system

The driver is solely responsible for safe driving. Always drive safely, taking care to observe your surroundings.

The Blind Spot Monitor function is a supplementary function which alerts the driver that a vehicle is present in the blind spot. Do not overly rely on the Blind Spot Monitor function. The function cannot judge if it is safe to change lanes, therefore over reliance could cause an accident resulting in death or serious injury.

According to conditions, the system may not function correctly. Therefore the driver's own visual confirmation of safety is necessary.

■ The Blind Spot Monitor function is operational when

- The Blind Spot Monitor system turned on.
- Vehicle speed is greater than approximately 16 km/h (10 mph).

■ The Blind Spot Monitor function will detect a vehicle when

- A vehicle in an adjacent lane overtakes your vehicle.
- Another vehicle enters the detection area when it changes lanes.

■ Conditions under which the Blind Spot Monitor function will not detect a vehicle

The Blind Spot Monitor function is not designed to detect the following types of vehicles and/or objects:

- Small motorcycles, bicycles, pedestrians etc.*
- Vehicles traveling in the opposite direction
- Guardrails, walls, signs, parked vehicles and similar stationary objects*
- Following vehicles that are in the same lane*
- Vehicles driving 2 lanes across from your vehicle*

*: Depending on conditions, detection of a vehicle and/or object may occur.

■ Conditions under which the Blind Spot Monitor function may not function correctly

- The Blind Spot Monitor function may not detect vehicles correctly in the following conditions:
 - During bad weather such as heavy rain, fog, snow etc.
 - When ice or mud etc. is attached to the rear bumper
 - When driving on a road surface that is wet due to rain, standing water etc.
 - When there is a significant difference in speed between your vehicle and the vehicle that enters the detection area
 - When a vehicle is in the detection area from a stop and remains in the detection area as your vehicle accelerates
 - When driving up or down consecutive steep inclines, such as hills, a dip in the road etc.
 - When multiple vehicles approach with only a small gap between each vehicle
 - When vehicle lanes are wide, and the vehicle in the next lane is too far away from your vehicle
 - When the vehicle that enters the detection area is traveling at about the same speed as your vehicle
 - When there is a significant difference in height between your vehicle and the vehicle that enters the detection area
 - Directly after the Blind Spot Monitor system turned on
 - When your vehicle is towing a trailer

- Instances of the Blind Spot Monitor function unnecessarily detecting a vehicle and/ or object may increase under the following conditions:
 - When there is only a short distance between your vehicle and a guardrail, wall etc.
 - When there is only a short distance between your vehicle and a following vehicle
 - When vehicle lanes are narrow and a vehicle driving 2 lanes across from your vehicle enters the detection area
 - When items such as a bicycle carrier are installed on the rear of the vehicle

The Rear Crossing Traffic Alert function (if equipped)

The Rear Crossing Traffic Alert functions when your vehicle is in reverse. It can detect other vehicles approaching from the right or left rear of the vehicle. It uses radar sensors to alert the driver of the other vehicle's existence through flashing the outside rear view mirror indicators and sounding a buzzer.

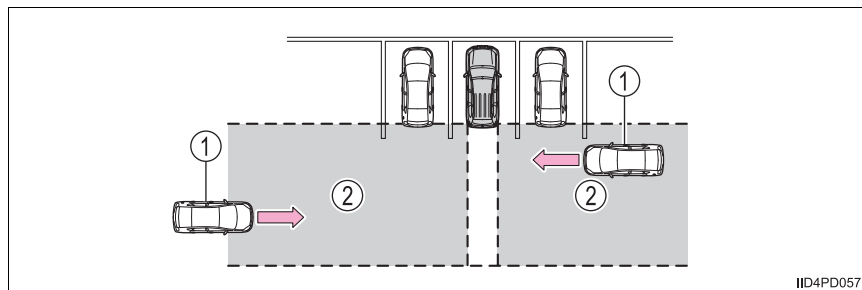

① Approaching vehicles

② Detection areas

⚠ CAUTION

■ Cautions regarding the use of the system

The driver is solely responsible for safe driving. Always drive safely, taking care to observe your surroundings.

The Rear Traffic Alert function is only an assist and is not a replacement for careful driving. Driver must be careful when backing up, even when using Rear Traffic Alert function. The driver's own visual confirmation of behind you and your vehicle is necessary and be sure there are no pedestrians, other vehicles etc. before backing up. Failure to do so could cause death or serious injury.

According to conditions, the system may not function correctly. Therefore the driver's own visual confirmation of safety is necessary.

The Rear Crossing Traffic Alert function detection areas

The areas that vehicles can be detected in are outlined below.

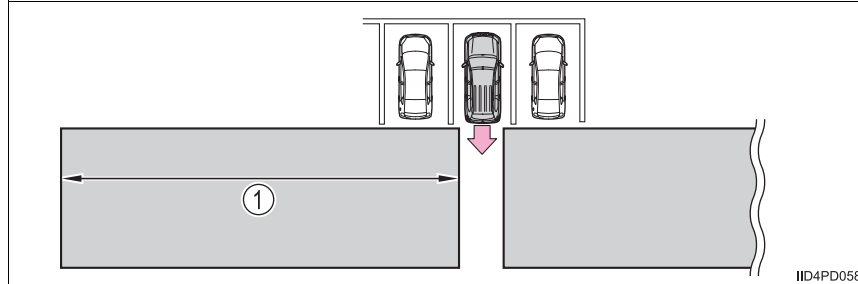

To give the driver a more consistent time to react, the buzzer can alert for faster vehicles from farther away.

Example:

Approaching vehicle	Speed	① Approximate alert distance
Fast	28 km/h (18 mph)	20 m (65 ft.)
Slow	8 km/h (5 mph)	5.5 m (18 ft.)

■ **The Rear Crossing Traffic Alert function is operational when**

- The Blind Spot Monitor system turned on.
- The shift lever is in R.
- Vehicle speed is less than approximately 8 km/h (5 mph).
- Approaching vehicle speed is between approximately 8 km/h (5 mph) and 28 km/h (18 mph).

■ **Conditions under which the Rear Crossing Traffic Alert function will not detect a vehicle**

The Rear Crossing Traffic Alert function is not designed to detect the following types of vehicles and/or objects.

- Small motorcycles, bicycles, pedestrians etc.*
- Vehicles approaching from directly behind
- Guardrails, walls, signs, parked vehicles and similar stationary objects*
- Vehicles moving away from your vehicle
- Vehicles approaching from the parking spaces next to your vehicle*
- Vehicles backing up in the parking space next to your vehicle*

*: Depending on conditions, detection of a vehicle and/or object may occur.

■ **Conditions under which the Rear Crossing Traffic Alert function may not function correctly**

The Rear Crossing Traffic Alert function may not detect vehicles correctly in the following conditions:

- During bad weather such as heavy rain, fog, snow etc.
- When ice or mud etc. is attached to the rear bumper
- When multiple vehicles approach continuously
- Shallow angle parking
- When a vehicle is approaching at high speed
- When parking on a steep incline, such as hills, a dip in the road etc.
- Directly after the Blind Spot Monitor system turned on
- When your vehicle is towing a trailer
- When items such as a bicycle carrier are installed on the rear of the vehicle
- Directly after the engine is started with the BSM main switch on
- When the sensors cannot detect vehicles because of obstacles

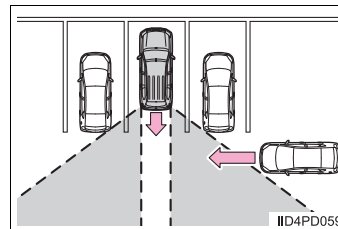

PCS (Pre-Crash Safety system)*

When the radar sensor detects possibility of a frontal collision, the pre-crash safety system such as the brakes and seat belts are automatically engaged to lessen impact as well as vehicle damage.

◆ Pre-crash seat belts (front seat belts only)

If the pre-crash sensor detects that a collision is unavoidable, the pre-crash safety system will retract the seat belt before the collision occurs.

The same will happen if the driver makes an emergency braking or loses control of the vehicle. (→P. 38)

However, when the VSC system is disabled, the system will not operate in the event of skidding.

◆ Pre-crash brake assist

When there is a high possibility of a frontal collision, the system applies greater braking force in relation to how strongly the brake pedal is depressed.

◆ Pre-crash braking (if equipped)

When there is a high possibility of a frontal collision, the system warns the driver using a warning light, warning display and buzzer. If the system determines that a collision is unavoidable, the brakes are automatically applied to reduce the collision speed. Pre-crash braking can be disabled using the pre-crash braking off switch.

◆ AVS (Adaptive Variable Suspension System) control (if equipped)

When the system determines that there is a high possibility of a frontal collision, the AVS optimizes the damping effect. (→Refer to the “Off-road Driving Owner’s Manual”)

*: If equipped

Disabling pre-crash braking (if equipped)

- ① Pre-crash braking disabled
- ② Pre-crash braking enabled

The “PCS” warning light turns on when pre-crash braking is disabled.

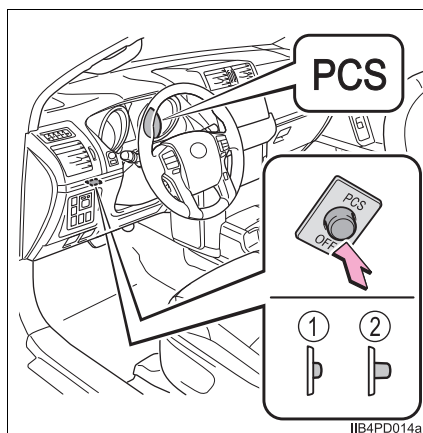
**Radar sensor**

The radar sensor detects vehicles or other obstacles on or near the road ahead and determines whether a collision is imminent based on the position, speed, and heading of the obstacles.

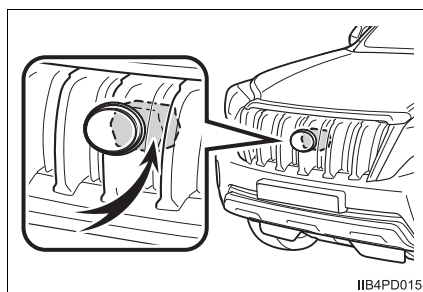

■ **The pre-crash safety system is operational when**

- Pre-crash seat belts (situation 1):
 - Vehicle speed is greater than about 5 km/h (4 mph).
 - The speed at which your vehicle is approaching the obstacle or the vehicle running ahead of you is greater than about 30 km/h (19 mph).
 - The front occupants are wearing a seat belt.
- Pre-crash seat belts (situation 2):
 - Vehicle speed is greater than about 30 km/h (19 mph).
 - The system detects sudden braking or skidding.
 - The front occupants are wearing a seat belt.
- Pre-crash brake assist:
 - Vehicle speed is greater than about 30 km/h (19 mph).
 - The speed at which your vehicle is approaching the obstacle or the vehicle running ahead of you is greater than about 30 km/h (19 mph).
 - The brake pedal is depressed.
- Pre-crash braking (if equipped):
 - The pre-crash braking off switch is not pressed.
 - Vehicle speed is greater than about 15 km/h (10 mph).
 - The speed at which your vehicle is approaching the obstacle or the vehicle running ahead of you is greater than about 15 km/h (10 mph).
- AVS (Adaptive Variable Suspension System) control (if equipped):
 - Vehicle speed is greater than about 5 km/h (4 mph).
 - The speed at which your vehicle is approaching the obstacle or the vehicle running ahead of you is greater than about 30 km/h (19 mph).

■ Conditions that may trigger the system even if there is no possibility of a collision

- When there is an object by the roadside at the entrance to a curve
- When passing an oncoming vehicle on a curve
- When driving over a narrow iron bridge
- When there is a metal object on the road surface
- When driving on an uneven road surface (nose up, nose down)
- When passing an oncoming vehicle on a right-turn (right-hand drive vehicles) or left-turn (left-hand drive vehicles)
- When your vehicle rapidly closes on the vehicle in front
- When a grade separation/interchange, sign, billboard, or other structure appears to be directly in the vehicle's line of travel
- When a billboard or other metallic structure appears to be in the direct line of travel due to driving on a hill
- When an extreme change in vehicle height occurs
- When the axis of the radar is out of adjustment
- When passing through certain toll gates
- When passing through an overpass
- When passing through a tunnel

When the system is activated in the situations described above, there is also a possibility that the seat belts will retract quickly and the brakes will be applied with a force greater than normal. When the seat belt is locked in the restricted position, stop the vehicle in a safe place, release the seat belt and refasten it.

■ **Situations in which the pre-crash safety system does not function properly**

The system may not function effectively in situations such as the following:

- On roads with sharp bends or uneven surfaces
- If a vehicle suddenly moves in front of your vehicle, such as at an intersection
- If a vehicle suddenly cuts in front of your vehicle, such as when overtaking
- In inclement weather such as heavy rain, fog, snow or sand storms
- When your vehicle is skidding with the VSC system off
- When an extreme change in vehicle height occurs
- When the axis of the radar is out of adjustment

■ **Automatic cancelation of pre-crash safety system**

When a malfunction occurs due to sensor contaminations, etc. that results in the sensors being unable to detect obstacles, the pre-crash safety system will be automatically disabled. In this case, the system will not activate even if there is a collision possibility.

■ **Obstacles not detected**

The sensor cannot detect plastic obstacles such as traffic cones. There may also be occasions when the radar sensor cannot detect pedestrians, animals, bicycles, motorcycles, trees, or snowdrifts.

■ **When there is a malfunction in the system, or if the system is temporarily unusable**

Warning lights and/or warning messages will turn on or flash. (→P. 606)

■ Certification



The latest “DECLARATION of CONFORMITY” (DoC) is available at the following:

<http://www.globaldenso.com/en/products/oem/index.html#2>

Hereby, DENSO CORPORATION declares that this DNMWR004 is in compliance with the essential requirements and other relevant provisions of Directive 1999/5/EC.
Hér með lýsir DENSO CORPORATION yfir því að DNMWR004 er í samræmi við grunnkröfur og aðrar kröfur, sem gerðar eru í tilskipun 1999/5/EC.
Con la presente DENSO CORPORATION dichiara che questo DNMWR004 è conforme ai requisiti essenziali ed alle altre disposizioni pertinenti stabilite dalla direttiva 1999/5/CE.
Käesolevaga kinnitab DENSO CORPORATION seadme DNMWR004 vastavust direktiivi 1999/5/EÜ põhinõuetele ja nimetatud direktiivist tulenevatele teistele asjakohastele sätetele.
Hierbij verklaart DENSO CORPORATION dat het toestel DNMWR004 in overeenstemming is met de essentiële eisen en de andere relevante bepalingen van richtlijn 1999/5/EG.
ΜΕ ΤΗΝ ΠΑΡΟΥΣΑ DENSO CORPORATION ΔΗΛΩΝΕΙ ΟΤΙ ΔNMWR004 ΣΥΜΜΟΡΦΩΝ ΕΤΑΙ ΠΡΟΣ ΤΙΣ ΟΥΣΙΩΔΕΙΣ ΑΠΑΙΤΗΣΕΙΣ ΚΑΙ ΤΙΣ ΛΟΙΠΕΣ ΣΧΕΤΙΚΕΣ ΔΙΑΤΑΞΕΙΣ ΤΗΣ ΟΔΗΓΙΑΣ 1999/5/ΕΚ.
Härmed intygar DENSO CORPORATION att denna DNMWR004 står i överensstämmelse med de väsentliga egenskapskrav och övriga relevanta bestämmelser som framgår av direktiv 1999/5/EG.
Por medio de la presente DENSO CORPORATION declara que el DNMWR004 cumple con los requisitos esenciales y cualesquiera otras disposiciones aplicables o exigibles de la Directiva 1999/5/CE.
DENSO CORPORATION tímto vyhlasuje, že DNMWR004 spĺňa základné požiadavky a všetky príslušné ustanovenia Smernice 1999/5/ES.
DENSO CORPORATION izjavlja, da je ta DNMWR004 v skladu z bistvenimi zahtevami in ostalimi relevantnimi določili direktive 1999/5/ES.
DENSO CORPORATION tímto prohlašuje, že tento DNMWR004 je ve shodě se základními požadavky a dalšími příslušnými ustanoveními směrnice 1999/5/ES.

<p>Undertegnede DENSO CORPORATION erklærer herved, at følgende udstyr DNMWR004 overholder de væsentlige krav og øvrige relevante krav i direktiv 1999/5/EF.</p>
<p>Hiermit erklärt DENSO CORPORATION, dass sich das Gerät DNMWR004 in Übereinstimmung mit den grundlegenden Anforderungen und den übrigen einschlägigen Bestimmungen der Richtlinie 1999/5/EG befindet.</p>
<p>DENSO CORPORATION erklærer herved at udstyret DNMWR004 er i samsvar med de grunnleggende krav og øvrige relevante krav i direktiv 1999/5/EF.</p>
<p>Alulírott, DENSO CORPORATION nyilatkozom, hogy a DNMWR004 megfelel a vonatkozó alapvető követelményeknek és az 1999/5/EC irányelv egyéb előírásainak.</p>
<p>DENSO CORPORATION vakuuttaa täten että DNMWR004 tyyppinen laite on direktiivin 1999/5/EY oleellisten vaatimusten ja sitä koskevien direktiivin muiden ehtojen mukainen.</p>
<p>Par la présente DENSO CORPORATION déclare que l'appareil DNMWR004 est conforme aux exigences essentielles et aux autres dispositions pertinentes de la directive 1999/5/CE.</p>
<p>Niniejszym DENSO CORPORATION oświadcza, że DNMWR004 jest zgodny z zasadniczymi wymogami oraz pozostałymi stosownymi postanowieniami Dyrektywy 1999/5/EC.</p>
<p>DENSO CORPORATION declara que este DNMWR004 está conforme com os requisitos essenciais e outras disposições da Directiva 1999/5/CE.</p>
<p>Hawnhekk, DENSO CORPORATION, jiddikjara li dan DNMWR004 jikkonforma mal-htigijiet essenzjali u ma provvedimenti oħrajn rilevanti li hemm fid-Direttiva 1999/5/EC.</p>
<p>Ar šo, DENSO CORPORATION, deklarē, ka DNMWR004 atbilst Direktīvas 1999/5/EK būtiskajām prasībām un citiem ar to saistītajiem noteikumiem.</p>
<p>Šiuo DENSO CORPORATION deklaruoja, kad šis DNMWR004 atitinka esminius reikalavimus ir kitas 1999/5/EB Direktyvos nuostatas.</p>

 CAUTION**■ Limitations of the pre-crash safety system**

Do not overly rely on the pre-crash safety system. Always drive safely, taking care to observe your surroundings and checking for any obstacles or other road hazards.

Failure to do so may cause an accident resulting in death or serious injury.

■ Cautions regarding the assist contents of the system

By means of alarms and brake control, the pre-crash safety system is intended to assist the driver in avoiding collisions through the process of LOOK-JUDGE-ACT. There are limits to the degree of assistance the system can provide, so please keep in mind the following important points.

● Assisting the driver in watching the road

The pre-crash safety system is only able to detect obstacles directly in front of the vehicle, and only within a limited range. It is not a mechanism that allows careless or inattentive driving, and it is not a system that can assist the driver in low-visibility conditions. It is still necessary for the driver to pay close attention to the vehicle's surroundings.

● Assisting the driver in making correct judgment

When attempting to estimate the possibility of a collision, the only data available to the pre-crash safety system is that from obstacles it has detected directly in front of the vehicle. Therefore, it is absolutely necessary for the driver to remain vigilant and to determine whether or not there is a possibility of collision in any given situation.

● Assisting the driver in taking action

The pre-crash safety system's braking assist feature is designed to help reduce the severity of a collision, and so only acts when the system has judged that a collision is unavoidable. This system by itself is not capable of automatically avoiding a collision or bringing the vehicle to a stop safely. For this reason, when encountering a dangerous situation the driver must take direct and immediate action in order to ensure the safety of all involved.

 CAUTION**■ When the sensor may not be correctly detecting the vehicle ahead**

Apply the brakes as necessary in any of the following situations.

- When water or snow thrown up by the surrounding vehicles hinders the functioning of the sensor
- When your vehicle is pointing upwards (caused by a heavy load in the luggage compartment etc.)
- Vehicles that cut in suddenly
- Vehicles with small rear ends (trailers with no load on board etc.)
- Motorcycles traveling in the same lane

■ Handling the radar sensor

Observe the following to ensure the pre-crash safety system can function effectively:

- Keep the sensor and front grille clean at all times.
Clean the sensor and front grille with a soft cloth so you do not mark or damage them.
- Do not subject the sensor or surrounding area to a strong impact.
If the sensor moves even slightly off position, the system may become inaccurate or malfunction. If the sensor or surrounding area is subject to a strong impact, always have the area inspected and adjusted by any authorized Toyota dealer or repairer, or another duly qualified and equipped professional.
- Do not disassemble the sensor.
- Do not attach accessories or stickers to the sensor, grille or surrounding area.
- Do not modify or paint the sensor and grille cover.

Winter driving tips

Carry out the necessary preparations and inspections before driving the vehicle in winter. Always drive the vehicle in a manner appropriate to the prevailing weather conditions.

Pre-winter preparations

- Use fluids that are appropriate to the prevailing outside temperatures.
 - Engine oil
 - Engine coolant
 - Washer fluid
- Have a service technician inspect the condition of the battery.
- Have the vehicle fitted with four snow tires or purchase a set of tire chains for the rear tires.

Ensure that all tires are the same size and brand, and that chains match the size of the tires.

Before driving the vehicle

Perform the following according to the driving conditions:

- Do not try to forcibly open a window or move a wiper that is frozen. Pour warm water over the frozen area to melt the ice. Wipe away the water immediately to prevent it from freezing.
- To ensure proper operation of the climate control system fan, remove any snow that has accumulated on the air inlet vents in front of the windshield.
- Check for and remove any excess ice or snow that may have accumulated on the exterior lights, vehicle's roof, chassis, around the tires or on the brakes.
- Remove any snow or mud from the bottom of your shoes before getting in the vehicle.

When driving the vehicle

Accelerate the vehicle slowly, keep a safe distance between you and the vehicle ahead, and drive at a reduced speed suitable to road conditions.

When parking the vehicle (in the winter time or in the cold latitudes)

Park the vehicle and move the shift lever to P (automatic transmission) or 1 or R (manual transmission) without setting the parking brake. The parking brake may freeze up, preventing it from being released. If necessary, block the wheels to prevent inadvertent sliding or creeping.

Selecting tire chains

Use the correct tire chain size when mounting the snow chains. Chain size is regulated for each tire size.

- ① Side chain
(5 mm [0.20 in.] in diameter)
- ② Cross chain
(6.3 mm [0.25 in.] in diameter)

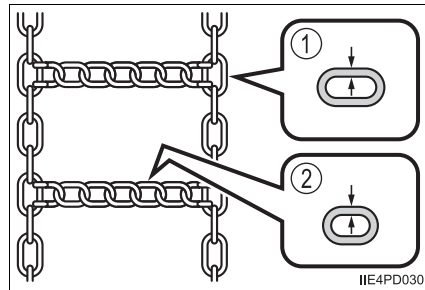

Regulations on the use of tire chains

Regulations regarding the use of tire chains vary depending on location and type of road. Always check local regulations before installing chains.

■ Tire chain installation

Observe the following precautions when installing and removing chains:

- Install and remove tire chains in a safe location.
- Install tire chains on the rear tires. Do not install tire chains on the front tires.
- Install tire chains on rear tires as tightly as possible. Retighten chains after driving 0.5 - 1.0 km (1/4 - 1/2 mile).
- Install tire chains following the instructions provided with the tire chains.

CAUTION

■ Driving with snow tires

Observe the following precautions to reduce the risk of accidents. Failure to do so may result in a loss of vehicle control and cause death or serious injury.

- Use tires of the specified size.
- Maintain the recommended level of air pressure.
- Do not drive at speeds in excess of the speed limit or the speed limit specified for the snow tires being used.
- Use snow tires on all, not just some wheels.

■ Driving with tire chains

Observe the following precautions to reduce the risk of accidents. Failing to do so may result in the vehicle being unable to be driven safely, and may cause death or serious injury.

- Do not drive in excess of the speed limit specified for the tire chains being used, or 50 km/h (30 mph), whichever is lower.
- Avoid driving on bumpy road surfaces or over potholes.
- Avoid sudden acceleration, abrupt steering, sudden braking and shifting operations that cause sudden engine braking.
- Slow down sufficiently before entering a curve to ensure that vehicle control is maintained.



NOTICE

■ Repairing or replacing snow tires (vehicles with the tire pressure warning system)

Request repairs or replacement of snow tires from Toyota dealers or legitimate tire retailers.

This is because the removal and attachment of snow tires affects the operation of the tire pressure warning valves and transmitters.

■ Fitting tire chains (vehicles with the tire pressure warning system)

The tire pressure warning valves and transmitters may not function correctly when tire chains are fitted.

Audio system

5

- 5-1. Basic Operations**
 - Audio system types392
 - Steering wheel audio switches.....393
 - AUX port/USB port394
- 5-2. Using the audio system**
 - Optimal use of the audio system395
- 5-3. Using the radio**
 - Radio operation397
- 5-4. Playing an audio CD and MP3/WMA discs**
 - CD player operation.....401
- 5-5. Using an external device**
 - Listening to an iPod409
 - Listening USB memory device416
 - Using the AUX port.....423
- 5-6. Using Bluetooth® devices**
 - Bluetooth® audio/phone.....424
 - Using the steering wheel switches429
 - Registering a Bluetooth® device430
- 5-7. “SETUP” menu**
 - Using the “SETUP” menu (“Bluetooth*” menu).....431
 - Using the “SETUP” menu (“TEL” menu)435
- 5-8. Bluetooth® Audio**
 - Operating a Bluetooth® enabled portable player ...439
- 5-9. Bluetooth® Phone**
 - Making a phone call.....441
 - Receiving a phone call.....443
 - Speaking on the phone.....444
- 5-10. Bluetooth®**
 - Bluetooth®446

*: Bluetooth is a registered trademark of Bluetooth SIG, Inc.

Audio system types*

- ▶ Vehicles with a navigation system or a multimedia system
Refer to the “Navigation system owner’s manual”.
- ▶ Vehicles without a navigation system or a multimedia system
CD player with AM/FM radio

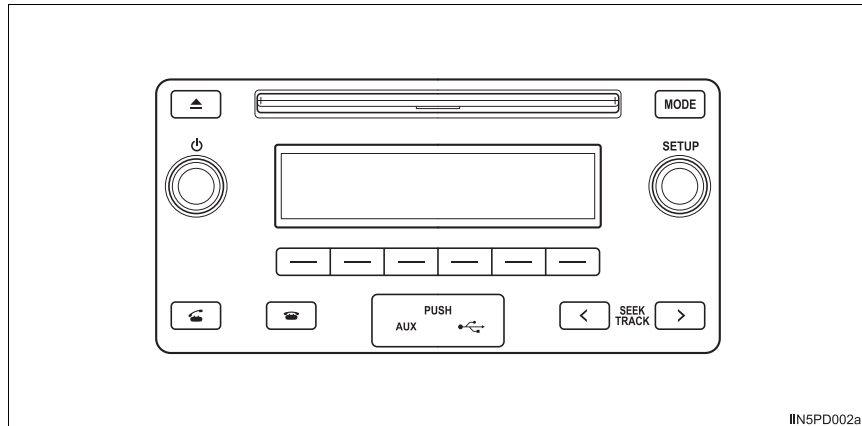

This illustration is for left-hand drive vehicles. Some button positions are reversed for right-hand drive vehicles.

■ Using cellular phones

Interference may be heard through the audio system’s speakers if a cellular phone is being used inside or close to the vehicle while the audio system is operating.

NOTICE

■ To prevent battery discharge

Do not leave the audio system on longer than necessary with the engine stopped.

■ To avoid damaging the audio system

Take care not to spill drinks or other fluids over the audio system.

*: If equipped

Steering wheel audio switches*

Some audio features can be controlled using the switches on the steering wheel.

Operation may differ depending on the type of audio system or navigation system. For details, refer to the manual provided with the audio system or navigation system.

Operating the audio system using the steering wheel switches

- ① Volume switch
 - Increases/decreases volume
 - Press and hold: Continuously increases/decreases volume
- ② Radio mode:
 - Press: Select a radio station
 - Press and hold: Seek up/down

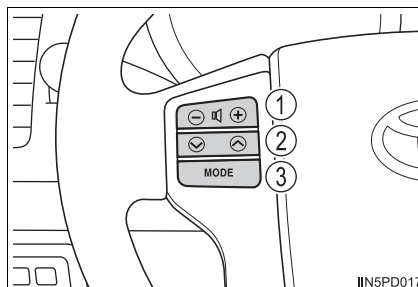

CD, MP3/WMA disc, Bluetooth®, iPod or USB mode:

- Press: Select a track/file/song
 - Press and hold: Select a folder or album (MP3/WMA disc, Bluetooth® or USB)
- ③ “MODE” switch
 - Turns the power on, selects audio source
 - Press and hold this switch to mute or pause the current operation. To cancel the mute or pause, press and hold the switch again.

⚠ CAUTION

■ To reduce the risk of an accident

Exercise care when operating the audio switches on the steering wheel.

*: If equipped

AUX port/USB port

Connect an iPod, USB memory device or portable audio player to the AUX port/USB port as indicated below. Press the “MODE” button to select “iPod”, “USB” or “AUX”.

Connecting using the AUX port/USB port

■ iPod

Open the cover and connect an iPod using an iPod cable.

Turn on the power of the iPod if it is not turned on.

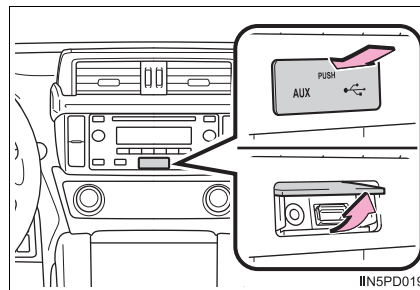

■ USB memory

Open the cover and connect the USB memory device.

Turn on the power of the USB memory device if it is not turned on.

■ Portable audio player

Open the cover and connect the portable audio player.

Turn on the power of the portable audio player if it is not turned on.

⚠ CAUTION

■ While driving

Do not connect a device or operate the device controls.

Optimal use of the audio system

The sound quality, volume balance and ASL settings can be adjusted.

- ① Displays the “SETUP” menu/
Selecting the mode
- ② Changes the following settings
 - Sound quality and volume balance
→P. 397
 - The sound quality and balance setting can be changed to produce the best sound.
 - Automatic Sound Levelizer
→P. 397

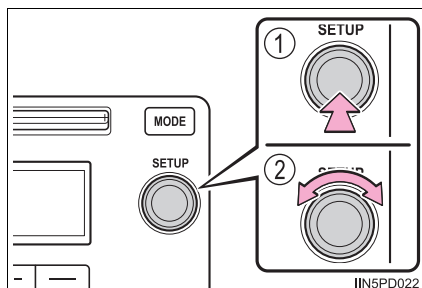

Using the audio control function

■ **Changing sound quality modes**

- 1 Press the tune/scroll knob.
- 2 Turn the knob to select “Sound Setting”.
- 3 Press the knob.
- 4 Turn the knob as corresponds to the desired mode.
“BASS”, “TREBLE”, “FADER”, “BALANCE”, or “ASL” can be selected.
- 5 Press the knob.

■ **Adjusting sound quality**

Turning the tune/scroll knob adjusts the level.

Sound quality mode	Mode displayed	Level	Turn to the left	Turn to the right
Bass*	“BASS”	-5 to 5	Low	High
Treble*	“TREBLE”	-5 to 5		
Front/rear volume balance	“FADER”	F7 to R7	Shifts to rear	Shifts to front
Left/right volume balance	“BALANCE”	L7 to R7	Shifts to left	Shifts to right

*: The sound quality level is adjusted individually in each audio mode.

Press the knob or  (BACK) to return to the sound setting menu.

■ **Adjusting the Automatic Sound Levelizer (ASL)**

When ASL is selected, turn the tune/scroll knob to change the amount of ASL.

“LOW”, “MID”, “HIGH”, or “OFF” can be selected.

ASL automatically adjusts the volume and tone quality according to vehicle speed.

Press the knob or  (BACK) to return to the sound setting menu.

Radio operation

Press the “MODE” button until “AM” or “FM” is displayed.

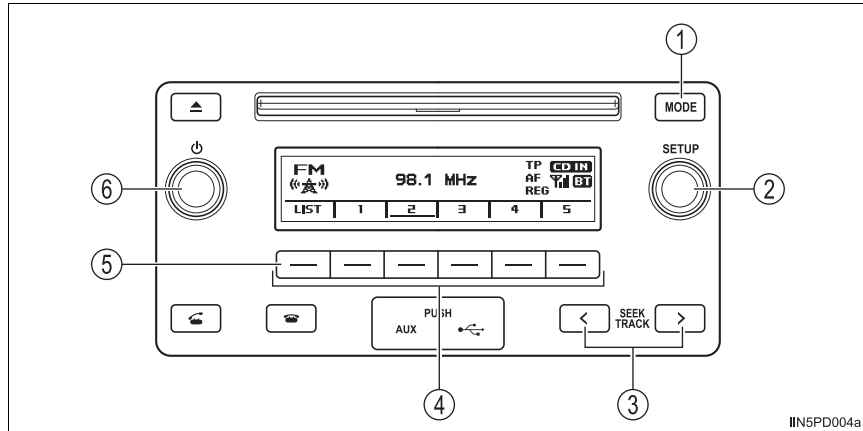

- | | |
|--|--|
| ① AM/FM mode button | ④ Station selectors |
| ② Tune/scroll knob
Press: AF/region code/TA mode setup
Turn: Adjusting the frequency | ⑤ Displaying the station list (FM mode only) |
| ③ Seeking the frequency | ⑥ Power/volume knob
Press: Turning the audio system on or off
Turn: Adjusting the volume |

Setting station presets

- 1 Search for the desired stations by turning the tune/scroll knob or pressing the “<” or “>” button of “SEEK TRACK”.
- 2 Press and hold a desired station selector button until you hear a beep.

Using the station list

■ Updating the station list

- 1 Press (LIST).

The station list will be displayed.

- 2 Press (UPDATE) to update the list.

“Updating” is displayed while the searching is in process, and then available stations will be listed on the display.

To cancel the updating process, press (BACK).

■ Selecting a station from the station list

- 1 Press (LIST).

The station list will be displayed.

- 2 Turn the tune/scroll knob to select a station.

- 3 Press the knob to tune in the station.

To return to the previous display, press (BACK).

RDS (Radio Data System)

This feature allows your radio to receive station.

■ Listening to stations of the same network

- 1 Press the tune/scroll knob.

- 2 Turn the knob to “RADIO” and press the knob.

- 3 Turn the knob as corresponds to the desired mode: “FM AF” or “Region code”.

- 4 Press the knob to select “ON” or “OFF”.

FM AF ON mode:

The station among those of the same network with strong reception is selected.

Region code ON mode:

The station among those of the same network with strong reception and broadcasting the same program is selected.

■ Traffic information

- 1 Press the tune/scroll knob.
- 2 Turn the knob to “RADIO” and press the knob.
- 3 Turn the knob to “FM TA” mode.
- 4 Press the knob to select “ON” or “OFF”.

TP mode:

The system automatically switches to traffic information when a broadcast with a traffic information signal is received.

The station returns to the previous one when the traffic information ends.

TA mode:

The system automatically switches to traffic information when a broadcast with a traffic information signal is received. In FM modes, the system will be mute unless traffic information is being broadcast.

The audio system returns to the previous mode when the traffic information ends.

■ **EON (Enhanced Other Network) system (for traffic announcement function)**

If the RDS station (with EON data) you are listening to is not broadcasting a traffic information program and the audio system is in the TA (traffic announcement) mode, the radio will be switched automatically to a station broadcasting a traffic information program in the EON AF list when traffic information begins.

■ **When the battery is disconnected**

Stations presets are erased.

■ **Reception sensitivity**

- Maintaining perfect radio reception at all times is difficult due to the continually changing position of the antenna, differences in signal strength and surrounding objects, such as trains, transmitters, etc.
- The radio antenna is mounted inside the rear quarter window. To maintain clear radio reception, do not attach metallic window tinting or other metallic objects to the antenna wire mounted inside the rear quarter window.

CD player operation

Insert a disc, press the “MODE” button to begin listening to a CD.

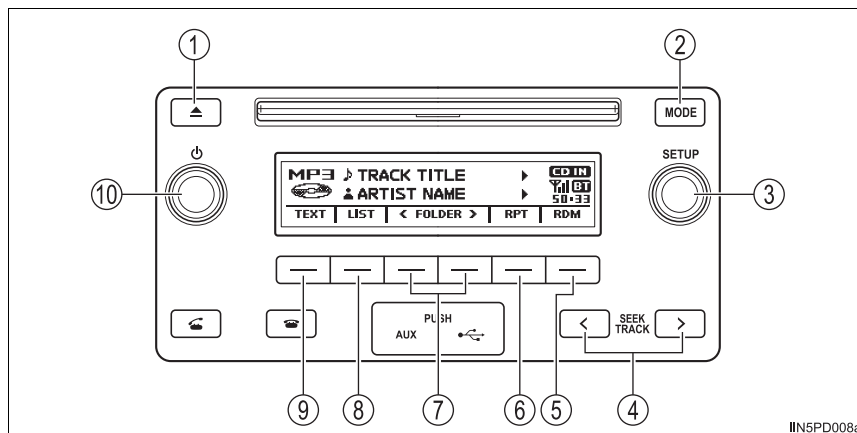

- | | |
|---|---|
| ① Disc eject | ⑥ Repeat play |
| ② Changing the audio source/
playback | ⑦ Selecting a folder (MP3/WMA
discs only) |
| ③ Tune/scroll knob
Selecting a track/file | ⑧ Displaying track/folder list |
| ④ Selecting a track/file, fast-for-
warding or rewinding | ⑨ Displaying text message |
| ⑤ Random play or back button | ⑩ Power/volume knob
Press: Turning the audio sys-
tem on or off
Turn: Adjusting the volume |

Loading CDs or MP3 and WMA discs

Insert a disc.

Ejecting CDs or MP3 and WMA discs

Press  and remove the disc.

Using the CD player

■ Selecting a track

Turn the tune/scroll knob or press the “<” or “>” button of “SEEK TRACK” to move up or down until the desired track number is displayed.

■ Selecting a track from a track list

1 Press  (LIST).

The track list will be displayed.

2 Turn and press the tune/scroll knob to select a track.

To return to the previous display, press  (BACK).

■ Fast-forwarding and rewinding tracks

Press and hold the “<” or “>” button of “SEEK TRACK”.

■ Random play

Press  (RDM).

To cancel, press the button again.

■ Repeat play

Press  (RPT).

To cancel, press the button again.

■ Switching the display



Press  (TEXT) to display or hide the CD title.

If there are continuing texts,  is displayed.

Press and hold the button to display the remaining texts.

Playing back MP3 and WMA discs

■ Selecting folders one at a time

Press  (<FOLDER) or  (FOLDER>) to select the desired folder.

■ Selecting a folder and file from folder list

1 Press  (LIST).

The folder list will be displayed.

2 Turn and press the tune/scroll knob to select a folder and a file.

To return to the previous display, press  (BACK).

■ Returning to the first folder

Press and hold  (<FOLDER) until you hear a beep.

■ Selecting a file

Turn the tune/scroll knob or press the “<” or “>” button of “SEEK TRACK” to select the desired file.

■ Fast-forwarding and rewinding files

Press and hold the “<” or “>” button of “SEEK TRACK”.

■ Random play

Pressing  (RDM) changes modes in the following order:
Folder random→Disc random→Off

■ Repeat play

Pressing  (RPT) changes modes in the following order:
File repeat→Folder repeat*→Off

*: Available except when RDM (random play) is selected

■ Switching the display

Press  (TEXT) to display or hide the album title.

If there are continuing texts,  is displayed.

Press and hold the button to display the remaining texts.

■ **Display**

Depending on the contents recorded, the characters may not be displayed properly or may not be displayed at all.

■ **Error messages**

If an error message is displayed, refer to the following table and take the appropriate measures. If the problem is not rectified, take the vehicle to any authorized Toyota dealer or repairer, or another duly qualified and equipped professional.

Message	Cause	Correction procedures
“CD CHECK”	<ul style="list-style-type: none"> • The disc is dirty or damaged. • The disc is inserted upside down. 	<ul style="list-style-type: none"> • Clean the disc. • Insert the disc correctly.
“ERROR”	There is a malfunction within the system.	Eject the disc.
“WAIT”	Operation has stopped due to a high temperature inside the player.	Wait for a while and then press the “MODE” button. Contact any authorized Toyota dealer or repairer, or another duly qualified and equipped professional if the CD still cannot be played.
“NO SUPPORT”	MP3/WMA files are not included in the CD.	Eject the disc.

■ **Discs that can be used**

Discs with the marks shown below can be used.
Playback may not be possible depending on recording format or disc features, or due to scratches, dirt or deterioration.



CDs with copy-protect features may not play correctly.

■ **CD player protection feature**

To protect the internal components, playback is automatically stopped when a problem is detected while the CD player is being used.

■ **If a CD is left inside the CD player or in the ejected position for extended periods**

The CD may be damaged and may not play properly.

■ **Lens cleaners**

Do not use lens cleaners. Doing so may damage the CD player.

■ **MP3 and WMA files**

MP3 (MPEG Audio LAYER3) is a standard audio compression format.

Files can be compressed to approximately 1/10 of their original size by using MP3 compression.

WMA (Windows Media Audio) is a Microsoft audio compression format.

This format compresses audio data to a size smaller than that of the MP3 format.

There is a limit to the MP3 and WMA file standards and to the media/formats recorded by them that can be used.

- MP3 file compatibility
 - Compatible standards
MP3 (MPEG1 LAYER3, MPEG2 LSF LAYER3)
 - Compatible sampling frequencies
MPEG1 LAYER3: 32, 44.1, 48 (kHz)
MPEG2 LSF LAYER3: 16, 22.05, 24 (kHz)
 - Compatible bit rates (compatible with VBR)
MPEG1 LAYER3: 32—320 (kbps)
MPEG2 LSF LAYER3: 8—160 (kbps)
 - Compatible channel modes: stereo, joint stereo, dual channel and monaural
- WMA file compatibility
 - Compatible standards
WMA Ver. 7, 8, 9
 - Compatible sampling frequencies
32, 44.1, 48 (kHz)
 - Compatible bit rates (only compatible with 2-channel playback)
Ver. 7, 8: CBR 48—192 (kbps)
Ver. 9: CBR 48—320 (kbps)

- **Compatible media**

Media that can be used for MP3 and WMA playback are CD-Rs and CD-RWs.

Playback in some instances may not be possible, depending on the status of the CD-R or CD-RW. Playback may not be possible or the audio may jump if the disc is scratched or marked with fingerprints.

- **Compatible disc formats**

The following disc formats can be used.

- Disc formats: CD-ROM Mode 1 and Mode 2
CD-ROM XA Mode 2, Form 1 and Form 2
- File formats: ISO9660 Level 1, Level 2, (Romeo, Joliet)
MP3 and WMA files written in any format other than those listed above may not play correctly, and their file names and folder names may not be displayed correctly.

Items related to standards and limitations are as follows.

- Maximum directory hierarchy: 8 levels
- Maximum length of folder names/file names: 32 characters
- Maximum number of folders: 192 (including the root)
- Maximum number of files per disc: 255

- **File names**

The only files that can be recognized as MP3/WMA and played are those with the extension .mp3 or .wma.

- **Multi-sessions**

As the audio system is compatible with multi-sessions, it is possible to play discs that contain MP3 and WMA files. However, only the first session can be played.

- **ID3 and WMA tags**

ID3 tags can be added to MP3 files, making it possible to record the track title and artist name, etc.

The system is compatible with ID3 Ver. 1.0, 1.1, and Ver. 2.2, 2.3, 2.4 ID3 tags. (The number of characters is based on ID3 Ver. 1.0 and 1.1.)

WMA tags can be added to WMA files, making it possible to record the track title and artist name in the same way as with ID3 tags.

- MP3 and WMA playback

When a disc containing MP3 or WMA files is inserted, all files on the disc are first checked. Once the file check is finished, the first MP3 or WMA file is played. To make the file check finish more quickly, we recommend you do not write in any files other than MP3 or WMA files or create any unnecessary folders.

If the discs contain a mixture of music data and MP3 or WMA format data, only music data can be played.

- Extensions

If the file extensions .mp3 and .wma are used for files other than MP3 and WMA files, they will be mistakenly recognized and played as MP3 and WMA files. This may result in large amounts of interference and damage to the speakers.

- Playback

- To play MP3 file with steady sound quality, we recommend a fixed bit rate of 128 kbps and a sampling frequency of 44.1 kHz.
- CD-R or CD-RW playback may not be possible in some instances, depending on the characteristics of the disc.
- There is a wide variety of freeware and other encoding software for MP3 and WMA files on the market, and depending on the status of the encoding and the file format, poor sound quality or noise at the start of playback may result. In some cases, playback may not be possible at all.
- When files other than MP3 or WMA files are recorded on a disc, it may take more time to recognize the disc and in some cases, playback may not be possible at all.
- Microsoft, Windows, and Windows Media are the registered trademarks of Microsoft Corporation in the U.S. and other countries.

 NOTICE

■ **Discs and adapters that cannot be used**

Do not use the following types of discs.
Also, do not use 8 cm (3 in.) disc adapters, DualDiscs or printable discs.
Doing so may damage the player and/or the disc insert/eject function.

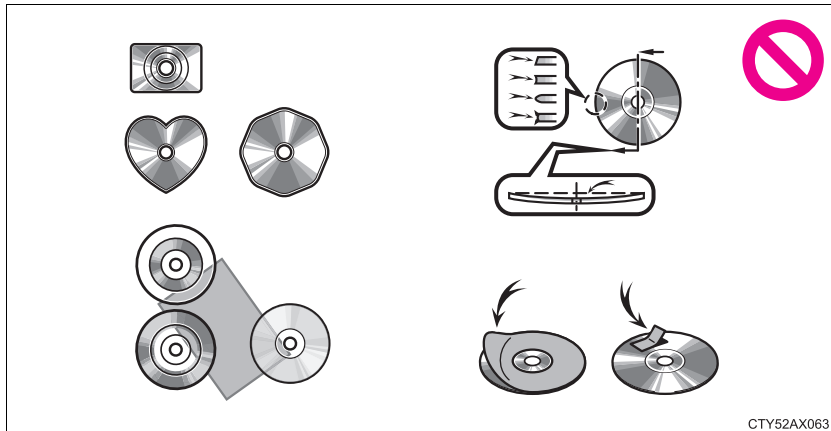

- Discs that have a diameter that is not 12 cm (4.7 in.).
- Low-quality or deformed discs.
- Discs with a transparent or translucent recording area.
- Discs that have tape, stickers or CD-R labels attached to them, or that have had the label peeled off.

■ **Player precautions**

Failure to follow the precautions below may result in serious damage to the discs or the player itself.

- Do not insert anything other than discs into the disc slot.
- Do not apply oil to the player.
- Store discs away from direct sunlight.
- Never try to disassemble any part of the player.

Listening to an iPod

Connecting an iPod enables you to enjoy music from the vehicle speakers. Press the “MODE” button until “iPod” is displayed.

Connecting an iPod

→P. 395

Control panel

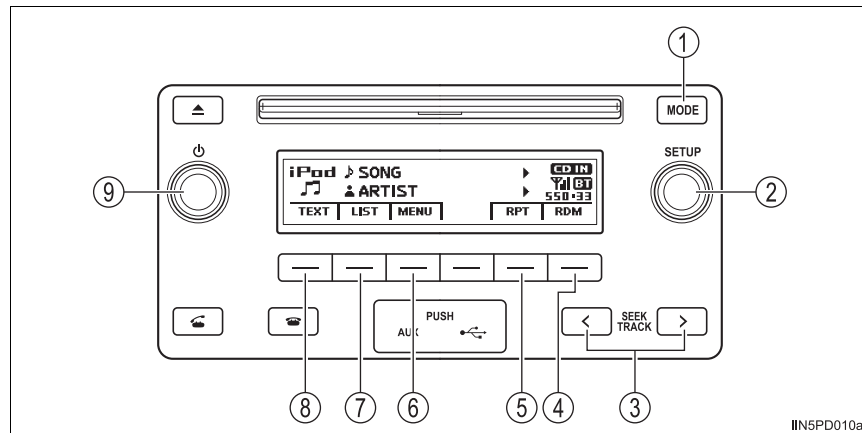

- | | |
|---|---|
| ① Changing the audio source/
playback | ⑥ iPod menu mode, playback |
| ② Tune/scroll knob
Selecting an iPod menu/song | ⑦ Displaying song list |
| ③ Selecting a song, fast-forwarding
or rewinding | ⑧ Displaying text message |
| ④ Random play or back button | ⑨ Power/volume knob
Press: Turning the audio system
on or off
Turn: Adjusting the volume |
| ⑤ Repeat play | |



Selecting a play mode

- 1 Press  (MENU) to select iPod menu mode.
- 2 Turning the tune/scroll knob clockwise changes the play mode in the following order:
 “Playlists” → “Artists” → “Albums” → “Songs” → “Podcasts” →
 “Genres” → “Composers” → “Audiobooks”
- 3 Press the knob to select the desired play mode.

■ **Play mode list**

Play mode	First selection	Second selection	Third selection	Fourth selection
“Playlists”	Playlists select	Songs select	-	-
“Artists”	Artists select	Albums select	Songs select	-
“Albums”	Albums select	Songs select	-	-
“Songs”	Songs select	-	-	-
“Podcasts”	Podcasts select	Episodes select	-	-
“Genres”	Genre select	Artists select	Albums select	Songs select
“Composers”	Composers select	Albums select	Songs select	-
“Audiobooks”	Audiobooks select	Chapter select	-	-



■ **Selecting a list**

- 1 Turn the tune/scroll knob to display the first selection list.
- 2 Press the knob to select the desired item and display the second selection list.
- 3 Repeat the same procedure to select the desired item.
 To return to the previous selection list, press  (BACK).
 Press  (PLAY) to play the desired selection.

Selecting songs

Turn the tune/scroll knob or press the “<” or “>” button of “SEEK TRACK” to select the desired song.

Selecting a song from the song list

- 1 Press  (LIST).
The song list will be displayed.
- 2 Turn the tune/scroll knob to select a song.
- 3 Press the knob to play the song.
To return to the previous display, press  (BACK).

Fast-forwarding and rewinding songs

Press and hold the “<” or “>” button of “SEEK TRACK”.



Repeat play

Press  (RPT).
To cancel, press the button again.

Random play

Pressing  (RDM) changes modes in the following order:
Track random→Album random→Off

Switching the display

Press  (TEXT) display or hide the album title.
If there are continuing texts,  is displayed.
Press and hold the button to display the remaining texts.

■ **About iPod**



- “Made for iPod” and “Made for iPhone” mean that an electronic accessory has been designed to connect specifically to iPod, or iPhone, respectively, and has been certified by the developer to meet Apple performance standards.
- Apple is not responsible for the operation of this device or its compliance with safety and regulatory standards. Please note that the use of this accessory with iPod or iPhone may affect wireless performance.
- iPhone, iPod, iPod classic, iPod nano, iPod shuffle, and iPod touch are trademarks of Apple Inc., registered in the U.S. and other countries.

■ **iPod functions**

- When an iPod is connected and the audio source is changed to iPod mode, the iPod will resume play from the same point in which it was last used.
- Depending on the iPod that is connected to the system, certain functions may not be available. Disconnecting the device and reconnecting it once again may resolve some malfunctions.
- While connected to the system, the iPod cannot be operated with its own controls. It is necessary to use the controls of the vehicle’s audio system instead.

■ **iPod problems**

To resolve most problems encountered when using your iPod, disconnect your iPod from the vehicle iPod connection and reset it. For instructions on how to reset your iPod, refer to your iPod Owner’s Manual.

■ **Display**

→P. 405

■ Error messages

If an error message is displayed, refer to the following table and take the appropriate measures. If the problem is not rectified, take the vehicle to any authorized Toyota dealer or repairer, or another duly qualified and equipped professional.

Message	Cause/Correction procedures
“ERROR”	This indicates a problem in the iPod or its connection.
“NO SONGS”	This indicates that there is no music data in the iPod.
“NO PLAYLIST”	This indicates that some available songs are not found in a selected playlist.
“UPDATE YOUR iPod”	This indicates that the version of the iPod is not compatible. Upgrade your iPod software to the latest version.

■ **Compatible models**

The following iPod®, iPod nano®, iPod classic®, iPod touch® and iPhone® devices can be used with this system.

- Made for
 - iPod touch (5th generation)
 - iPod touch (4th generation)
 - iPod touch (3rd generation)
 - iPod touch (2nd generation)
 - iPod touch (1st generation)
 - iPod classic
 - iPod with video
 - iPod nano (7th generation)
 - iPod nano (6th generation)
 - iPod nano (5th generation)
 - iPod nano (4th generation)
 - iPod nano (3rd generation)
 - iPod nano (2nd generation)
 - iPod nano (1st generation)
 - iPhone 5
 - iPhone 4S
 - iPhone 4
 - iPhone 3GS
 - iPhone 3G
 - iPhone

Depending on differences between models or software versions etc., some models might be incompatible with this system.

Items related to standards and limitations are as follows:

- Maximum number of lists in device: 9999
- Maximum number of songs in device: 65535
- Maximum number of songs per list: 65535

 CAUTION■ **While driving**

Do not connect iPod or operate the controls. Doing so may cause an accident, resulting in death or serious injury.

 NOTICE■ **To prevent damage to iPod or its terminal**

- Do not leave iPod in the vehicle. The temperature inside the vehicle may become high.
- Do not push down on or apply unnecessary pressure to the iPod while it is connected.
- Do not insert foreign objects into the port.

Listening USB memory device

Connecting a USB memory enables you to enjoy music from the vehicle speakers. Press the “MODE” button until “USB” is displayed.

Connecting a USB memory

→P. 395

Control panel

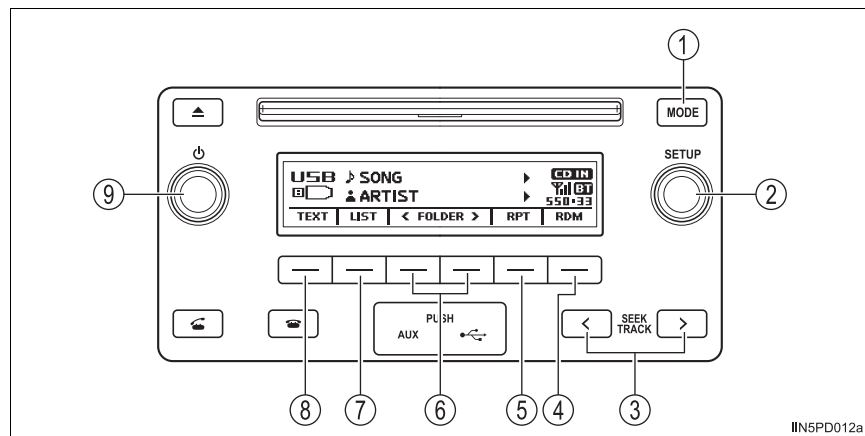

- | | |
|---|---|
| ① Changing the audio source/
playback | ⑥ Selecting a folder |
| ② Tune/scroll knob
Selecting a file | ⑦ Displaying folder list |
| ③ Selecting a song, fast-forward-
ing or rewinding | ⑧ Displaying text message |
| ④ Random play or back button | ⑨ Power/volume knob
Press: Turning the audio sys-
tem on or off
Turn: Adjusting the volume |
| ⑤ Repeat play | |

Selecting a folder

■ Selecting folders one at a time

Press (<FOLDER) or (FOLDER>) to select the desired folder.

■ Selecting a folder and file from folder list

1 Press (LIST).

The folder list will be displayed.

2 Turn and press the tune/scroll knob to select a folder and file.

To return to the previous display, press (BACK).

■ Returning to the first folder

Press and hold (<FOLDER) until you hear a beep.

Selecting a file

Turn the tune/scroll knob or press the "<" or ">" button of "SEEK TRACK" to select the desired file.

Fast-forwarding and rewinding files

Press and hold the “<” or “>” button of “SEEK TRACK”.

Random play

Pressing  (RDM) changes modes in the following order:
Folder random→All folder random→Off

Repeat play

Pressing  (RPT) changes modes in the following order:
File repeat→Folder repeat*→Off

*: Available except when RDM (random play) is selected

Switching the display

Press  (TEXT) to display or hide the album title.

If there are continuing texts,  is displayed.

Press and hold the button to display the remaining texts.

■ USB memory functions

- Depending on the USB memory that is connected to the system, the device itself may not be operable and certain functions may not be available. If the device is inoperable or a function is unavailable due to a malfunction (as opposed to a system specification), disconnecting the device and reconnecting it once again may resolve the problem.
- If the USB memory still does not begin operation after being disconnected and reconnected, format the memory.

■ Display

→P. 405

■ Error messages

If an error message is displayed, refer to the following table and take the appropriate measures. If the problem is not rectified, take the vehicle to any authorized Toyota dealer or repairer, or another duly qualified and equipped professional.

Message	Cause/Correction procedures
"ERROR"	This indicates a problem in the USB memory or its connection.
"NO MUSIC"	This indicates that no MP3/WMA files are included in the USB memory.

■ USB memory

- Compatible devices
USB memory that can be used for MP3 and WMA playback

● Compatible device formats

The following device formats can be used:

- USB communication formats: USB2.0 FS (12mbps)
- File formats: FAT12/16/32 (Windows)
- Correspondence class: Mass storage class

MP3 and WMA files written in any format other than those listed above may not play correctly, and their file names and folder names may not be displayed correctly.

Items related to standards and limitations are as follows:

- Maximum directory hierarchy: 8 levels
- Maximum number of folders in a device: 999 (including the root)
- Maximum number of files in a device: 9999
- Maximum number of files per folder: 255

- MP3 and WMA files

MP3 (MPEG Audio LAYER3) is a standard audio compression format.

Files can be compressed to approximately 1/10 of their original size by using MP3 compression.

WMA (Windows Media Audio) is a Microsoft audio compression format.

This format compresses audio data to a size smaller than that of the MP3 format.

There is a limit to the MP3 and WMA file standards and to the media/formats recorded by them that can be used.

- MP3 file compatibility

- Compatible standards

MP3 (MPEG1 LAYER3, MPEG2 LSF LAYER3)

- Compatible sampling frequencies

MPEG1 LAYER3: 32, 44.1, 48 (kHz)

MPEG2 LSF LAYER3: 16, 22.05, 24 (kHz)

- Compatible bit rates (compatible with VBR)

MPEG1 LAYER3: 32—320 (kbps)

MPEG2 LSF LAYER3: 8—160 (kbps)

- Compatible channel modes: stereo, joint stereo, dual channel and monaural

- WMA file compatibility

- Compatible standards

WMA Ver. 7, 8, 9

- Compatible sampling frequencies

32, 44.1, 48 (kHz)

- Compatible bit rates (only compatible with 2-channel playback)

Ver. 7, 8: CBR 48—192 (kbps)

Ver. 9: CBR 48—320 (kbps)

- File names

The only files that can be recognized as MP3/WMA and played are those with the extension .mp3 or .wma.

- ID3 and WMA tags

ID3 tags can be added to MP3 files, making it possible to record the track title, artist name, etc.

The system is compatible with ID3 Ver. 1.0, 1.1, and Ver. 2.2, 2.3, 2.4 ID3 tags. (The number of characters is based on ID3 Ver. 1.0 and 1.1.)

WMA tags can be added to WMA files, making it possible to record the track title and artist name in the same way as with ID3 tags.

- MP3 and WMA playback

- When a device containing MP3 or WMA files is connected, all files in the USB memory device are checked. Once the file check is finished, the first MP3 or WMA file is played. To make the file check finish more quickly, we recommend that you do not include any files other than MP3 or WMA files or create any unnecessary folders.
- When the USB device is connected and the audio source is changed to USB memory mode, the USB device will start playing the first file in the first folder. If the same device is removed and reinserted (and the contents have not been changed), the USB memory will resume play from the same point in which it was last used.

- Extensions

If the file extensions .mp3 and .wma are used for files other than MP3 and WMA files, they will be skipped (not played).

- Playback
 - To play MP3 files with steady sound quality, we recommend a fixed bit rate of at least 128 kbps and a sampling frequency of 44.1 kHz.
 - There is a wide variety of freeware and other encoding software for MP3 and WMA files on the market, and depending on the status of the encoding and the file format, poor sound quality or noise at the start of playback may result. In some cases, playback may not be possible at all.
 - Microsoft, Windows, and Windows Media are registered trademarks of Microsoft Corporation in the U.S.A. and other countries.

 CAUTION

■ **While driving**

Do not connect USB memory or operate the controls. Doing so may cause an accident, resulting in death or serious injury.

 NOTICE

■ **To prevent damage to USB memory or its terminal**

- Do not leave USB memory in the vehicle. The temperature inside the vehicle may become high.
- Do not push down on or apply unnecessary pressure to the USB memory while it is connected.
- Do not insert foreign objects into the port.

Using the AUX port

This port can be used to connect a portable audio device and listen to it using the vehicle's speakers. Press the "MODE" button until "AUX" is displayed.

Connecting a portable player

→P. 395

■ Operating portable audio devices connected to the audio system

The volume can be adjusted using the vehicle's audio controls. All other adjustments must be made on the portable audio device itself.

■ When using a portable audio device connected to the power outlet

Noise may occur during playback. Use the power source of the portable audio device.

Bluetooth® audio/phone*

The following can be performed using Bluetooth® wireless communication:

◆ Bluetooth® audio

The Bluetooth® audio system enables you to enjoy music played on a portable digital audio player (portable player) from the vehicle speakers via wireless communication.

This audio system supports Bluetooth®, a wireless data system capable of playing portable audio music without cables. If your portable player does not support Bluetooth®, the Bluetooth® audio system will not function.

◆ Bluetooth® phone (hands-free phone system)

This system supports Bluetooth®, which allows you to make or receive calls without using cables to connect a cellular phone and the system, and without operating the cellular phone.

*: If equipped

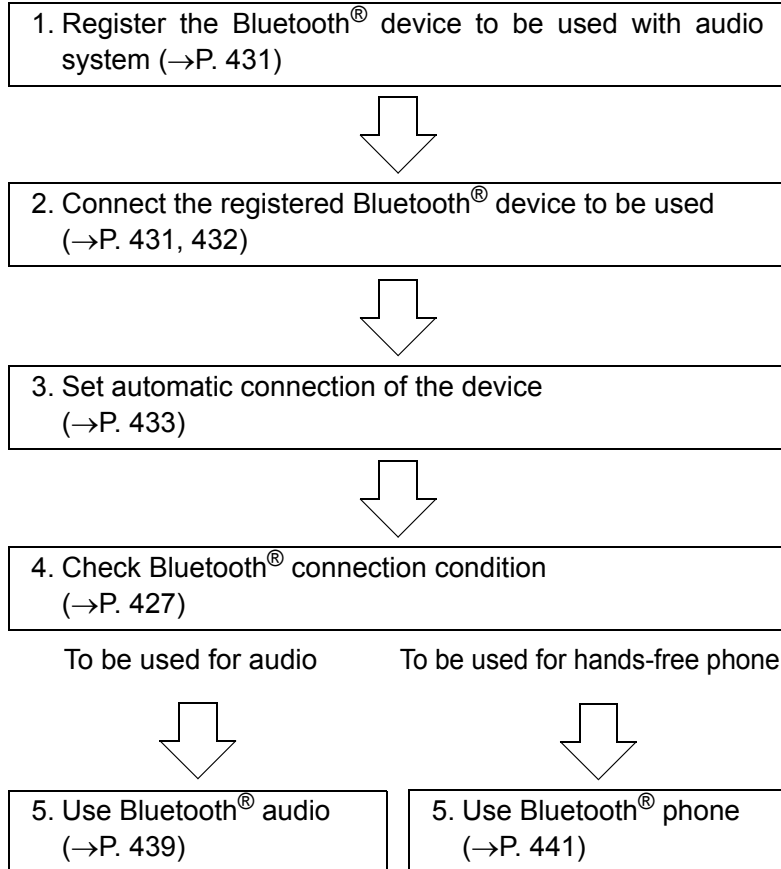
Device registration/connection flow

Audio unit

- ① Power/volume knob
 Press: Turning the audio system on or off
 Turn: Adjusting the volume
- ② Bluetooth® connection condition
 If “BT” is not displayed, the Bluetooth® audio/phone cannot be used.
- ③ Display
 A message, name, number, etc. is displayed.
 Lower-case characters and special characters may not be displayed.
- ④ Tune/scroll knob
 Displays set up menu or selects items such as menu and number
 Turn: Selects an item
 Press: Displays set up menu or inputs the selected item
- ⑤ Selects speed dials (Bluetooth® phone operation)
- ⑥ On-hook switch
 Turns the hands-free system off/ends a call/refuses a call
- ⑦ Off-hook switch
 Turns the hands-free system on/starts a call
- ⑧ Press and hold: Displays information that is too long to be displayed at one time on the display (Bluetooth® audio operation)

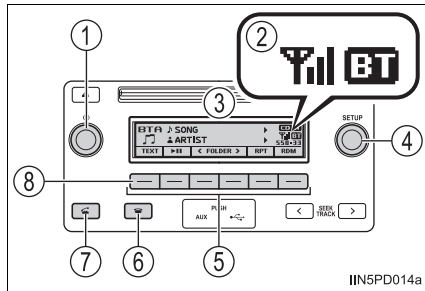

Microphone

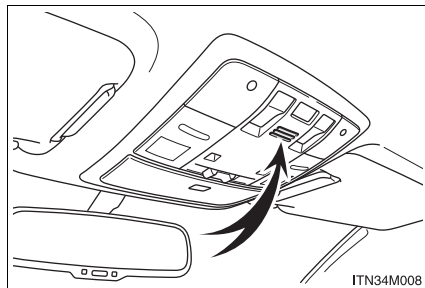

Menu list of the Bluetooth® audio/phone

To enter a menu, press the tune/scroll knob and navigate menus by using the knob.

First menu	Second menu	Third menu	Operation details
"Bluetooth*"	"Pairing"	-	Registering a Bluetooth® device
	"List phone"	-	Listing the registered cellular phones
	"List audio"	-	Listing the registered portable players
	"Passkey"	-	Changing the pass-key
	"BT Power"	-	Setting automatic connection of the device on or off
	"Bluetooth* info"	"Device name" "Device address"	Displaying the device status
	"Display setting"	-	Setting the automatic connection confirmation display to on or off
	"Initialize"	-	Initializing the settings

*: Bluetooth is a registered trademark of Bluetooth SIG, Inc.

First menu	Second menu	Third menu	Operation details
"TEL"	"Phonebook"	"Add contacts"	Adding a new number
		"Add SD"	Registering a speed dial
		"Delete call history"	Deleting a number stored in the call history
		"Delete contacts"	Deleting a number stored in the phonebook
		"Delete other PB"	Deleting a phonebook's data
	"HF sound setting"	"Call volume"	Setting call volume
		"Ringtone volume"	Setting ring tone volume
		"Ringtone"	Setting the ring tone
	"Transfer histories"	-	Transferring the call histories

■ **Bluetooth® audio/phone system functions**

Depending on the Bluetooth® device, certain functions may not be available.

Using the steering wheel switches

The steering wheel switches can be used to operate a connected cellular phone, or portable digital audio player (portable player).

Operating Bluetooth® phone using the steering wheel switches

- ① Volume
The voice guidance volume cannot be adjusted using this button.
- ② On-hook switch
Turns the hands-free system off/ends a call/refuse a call
- ③ Off-hook switch
Turns the hands-free system on/start a call

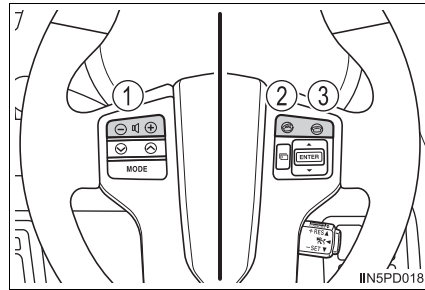

Registering a Bluetooth® device

Before using the Bluetooth® audio/phone, it is necessary to register a Bluetooth® device in the system. You can register up to 5 Bluetooth® devices.

How to register a Bluetooth® device

- 1 Press the tune/scroll knob and select “Bluetooth*” using the knob.
- 2 Press the knob and select “Pairing” using the knob.
A passkey will be displayed.
- 3 SSP (Secure Simple Pairing) incompatible Bluetooth® devices:
Input the passkey into the device.
SSP (Secure Simple Pairing) compatible Bluetooth® devices:
Select “YES” to register the device. Depending on the type of device, it may register automatically.

If a Bluetooth® device has both music player and cellular phone functions, both functions will be registered at the same time. When deleting the device, both functions will be deleted at the same time.

If the off-hook switch is pressed and the “TEL” mode is entered when no phones have been registered, the registration screen will be automatically displayed.

*: Bluetooth is a registered trademark of Bluetooth SIG, Inc.

Using the "SETUP" menu ("Bluetooth*" menu)

Registering a Bluetooth® device in the system allows the system to function. The following functions can be used for registered devices:

Registering a portable player

Select "Pairing" using the tune/scroll knob (→P. 428), and perform the procedure for registering a portable player. (→P. 431)

Listing the registered cellular phones

Select "List Phone" using the tune/scroll knob. (→P. 428) The list of registered cellular phones will be displayed.

- Connecting the registered cellular phone to the audio system
 - 1 Select the name of the cellular phone to be connected using the tune/scroll knob.
 - 2 Select "Select" using the knob.
- Deleting a registered cellular phone
 - 1 Select the name of the cellular phone to be deleted using the tune/scroll knob.
 - 2 Select "Delete" using the knob.
 - 3 Press (YES).
- Disconnecting the registered cellular phone from the audio system
 - 1 Select the name of the cellular phone to be disconnected using the tune/scroll knob.
 - 2 Select "Disconnect" using the knob.
 - 3 Press (YES).

*: Bluetooth is a registered trademark of Bluetooth SIG, Inc.

Listing the registered portable players

Select "List Audio" using the tune/scroll knob. (→P. 428) The list of registered portable players will be displayed.

- Connecting the registered portable player to the audio system
 - 1 Select the name of the portable player to be connected using the tune/scroll knob.
 - 2 Select "Select" using the knob.
- Deleting the registered portable player
 - 1 Select the name of the portable player to be deleted using the tune/scroll knob.
 - 2 Select "Delete" using the knob.
 - 3 Press (YES).
- Disconnecting the registered portable player from the audio system
 - 1 Select the name of the portable player to be disconnected using the tune/scroll knob.
 - 2 Select "Disconnect" using the knob.
 - 3 Press (YES).
- Selecting the connection method
 - 1 Select the name of the desired portable player using the tune/scroll knob.
 - 2 Select "Connection method" using the knob.
 - 3 Select "From vehicle" or "From audio" using the knob.

Changing the passkey

- 1 Select "Passkey" using the tune/scroll knob. (→P. 428)
- 2 Select a 4 to 8-digit passkey using the knob.
Input the number 1 digit at a time.
- 3 When the entire number to be registered as a passkey has been input, press (ENTER).
If the passkey to be registered has 8 digits, pressing (ENTER) is not necessary.

Setting automatic connection of the device on or off

If "BT Power" is set to on, the registered device will be connected automatically when the engine switch is turned to the "ACC" position (vehicles without a smart entry & start system) or ACCESSORY mode (vehicles with a smart entry & start system).

- 1 Select "BT Power" using the tune/scroll knob. (→P. 428)
- 2 Select "ON" or "OFF" using the knob.

Displaying the device status

Select "Bluetooth* info" using the tune/scroll knob. (→P. 428)

- Displaying the device name
Select "Device name" using the tune/scroll knob.
- Displaying the device address
Select "Device address" using the tune/scroll knob.

*: Bluetooth is a registered trademark of Bluetooth SIG, Inc.

Setting the automatic connection confirmation display to on or off

If the "Display setting" is set to on, the portable player connection status will be displayed when the engine switch is turned to the "ACC" or "ON" position (vehicles without a smart entry & start system) or ACCESSORY or IGNITION ON mode (vehicles with a smart entry & start system).

- 1 Select "Display setting" using the tune/scroll knob. (→P. 428)
- 2 Select "ON" or "OFF" using the knob.

Initialization

Select "Initialize" using the tune/scroll knob. (→P. 428)

- Initializing the sound settings

Select "Sound setting" using the tune/scroll knob and press (YES).

For details about sound settings: →P. 436

- Initializing the device information

Select "Car device info" using the tune/scroll knob and press (YES).

Automatic connection of a portable device, automatic connection confirmation display and the passkey will be initialized.

- Initializing the all settings

Select "All initialize" using the tune/scroll knob and press (YES).

Using the "SETUP" menu ("TEL" menu)

Adding a new phone number

Select "Add contacts" using the tune/scroll knob. (→P. 428)

- Transferring all contacts from the cellular phone

Select "Overwrite all" using the tune/scroll knob and press (YES).

- Transferring one contact from the cellular phone

Select "Add one contact" using the tune/scroll knob and press (YES).

Setting speed dials

1 Select "Add SD" using the tune/scroll knob. (→P. 428)

2 Select the desired data using the knob.

3 Press the desired preset button (from [1] to [5]).

For details about setting speed dials from the call history: →P. 442

For details about deleting speed dials: →P. 441

Deleting call histories

Select "Delete call history" using the tune/scroll knob. (→P. 428)

- Deleting outgoing call history

1 Select "Outgoing Calls" using the tune/scroll knob.

2 Select the desired phone number using the knob and press (YES).

To delete all outgoing call history data, press (ALL) and then press (YES).

- Deleting incoming call history

- 1 Select "Incoming Calls" using the tune/scroll knob.
- 2 Select the desired phone number using the knob and press (YES).

To delete all incoming call history data, press (ALL) and then press (YES).

- Deleting missed call history

- 1 Select "Missed Calls" using the tune/scroll knob.
- 2 Select the desired phone number using the knob and press (YES).

To delete all missed call history data, press (ALL) and then press (YES).

- Deleting a number from all call histories (Outgoing calls, Incoming calls and Missed calls)

- 1 Select "All Calls" using the tune/scroll knob.
- 2 Select the desired phone number using the knob and press (YES).

To delete all of the call histories data, press (ALL) and then press (YES).

Deleting a registered phone number

- 1 Select "Delete contacts" using the tune/scroll knob. (→P. 428)
- 2 Select the desired phone number using the knob and press (YES).

To delete all the registered phone numbers, press (ALL) and then press (YES).

Press (A-Z) to display the registered names in alphabetical order of the initial.

Deleting another cellular phone's phonebook

- 1 Select "Delete other PB" using the tune/scroll knob. (→P. 428)
- 2 Select the desired phonebook using the knob and press (YES).

Setting call volume

- 1 Select "Call volume" using the tune/scroll knob. (→P. 428)
- 2 Change the call volume.

To decrease the volume: Turn the knob counterclockwise.

To increase the volume: Turn the knob clockwise.

To set the volume, press (BACK).

Setting ring tone volume

- 1 Select "Ringtone volume" using the tune/scroll knob. (→P. 428)
- 2 Change the ring tone volume.
To decrease the volume: Turn the knob counterclockwise.
To increase the volume: Turn the knob clockwise.
To set the volume, press (BACK).

Setting ring tone

- 1 Select "Ringtone" using the tune/scroll knob. (→P. 428)
- 2 Using the knob, select a ring tone (1 - 3). To set the selected ring tone, press (BACK).

Transferring call histories

Select "Transfer histories" using the tune/scroll knob (→P. 428) and press (YES).

■ Phone number

Up to 1000 names can be stored.

■ Call history

Up to 10 numbers can be stored in each of the outgoing, incoming and missed call history memories.

■ Limitation of number of digits

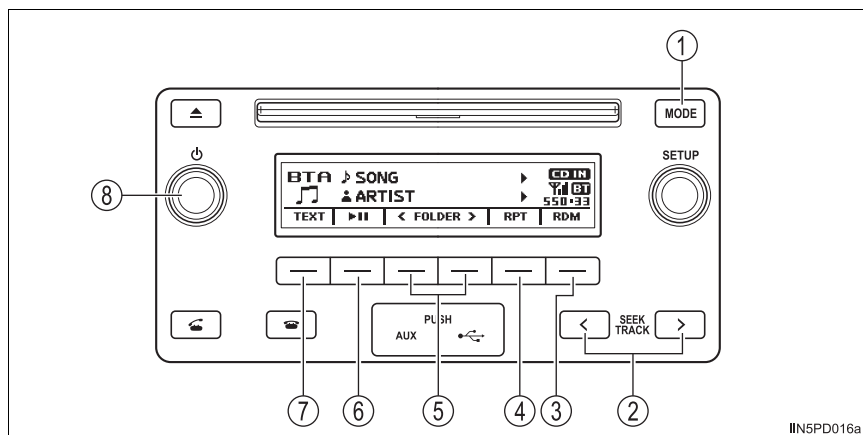

A phone number that exceeds 24 digits cannot be registered.

Operating a Bluetooth® enabled portable player



- ① Changing the audio source/ playback
- ② Selecting a track, fast-forwarding or rewinding
- ③ Random play or back button
- ④ Repeat play
- ⑤ Selecting an album
- ⑥ Playback/pause
- ⑦ Displaying text message
- ⑧ Power/volume knob
Press: Turning the audio system on or off
Turn: Adjusting the volume

Selecting an album

Press  (<FOLDER) or  (FOLDER>) to select desired album.

Selecting a track

Press the “<” or “>” button of “SEEK TRACK” to select the desired track.

Fast-forwarding and rewinding tracks

Press and hold the “<” or “>” button of “SEEK TRACK”.

Repeat play

Pressing  (RPT) changes modes in the following order:
Track repeat→Album repeat→Off

Random play

Pressing  (RDM) changes modes in the following order:
Album random→All track random→Off

Playing and pausing tracks

Press  (▶||).

Switching the display

Press  (TEXT) to display or hide the album title.

If there are continuing texts,  is displayed.

Press and hold the button to display the remaining texts.

■ Bluetooth® audio system functions

Depending on the portable player that is connected to the system, certain functions may not be available.

■ Display

→P. 405

Making a phone call

To enter the “TEL” mode, press the off-hook switch.

Dialing by selecting a name

- 1 Select “Phonebook” using the tune/scroll knob.
- 2 Select the desired name using the knob and press the off-hook switch.

By pressing (Add S. Dial) and one of the speed dial buttons (from [1] to [5]) while the desired name is selected, it can be registered as a speed dial.

Press (A-Z) to display the registered names in alphabetical order of the initial.

Speed dialing

- 1 Select “Speed dials” using the tune/scroll knob.
- 2 Press the desired preset button (from [1] to [5]) and press the off-hook switch.

To delete a registered speed dial, after selecting the desired preset button (from [1] to [5]) press (DELETE) and then press (YES).

Dialing by entering the number

- 1 Select “Dial by number” using the tune/scroll knob.
- 2 Enter the phone number and press the off-hook switch.

Dialing from call histories

- 1 Select “All Calls”, “Missed Calls”, “Incoming Calls” or “Outgoing Calls” using the tune/scroll knob.
- 2 Select a desired number using the knob and press the off-hook switch.

The following operations can be performed:

- Registering a number as a speed dial

Press (Add S. Dial) and then press the desired preset button (from [1] to [5]).

- Deleting the selected number

Press (DELETE) and press (YES).

Receiving a phone call

Answering the phone

Press the off-hook switch.

Refusing the call

Press the on-hook switch.

Receiving a call when on another call

Press the off-hook switch.

Pressing the off-hook switch again returns you to the previous call.

Adjusting the ring tone volume when receiving a call

To decrease the volume: Turn the power/volume knob counterclockwise.

To increase the volume: Turn the power/volume knob clockwise.

Speaking on the phone

Transferring a call

A call can be transferred between the cellular phone and system while dialing, receiving a call, or during a call. Use one of the following methods:

- a. Operate the cellular phone.
Refer to the manual that comes with the cellular phone for the operation of the phone.

- b. Press the  (PHONE).*



*: This operation can be performed only when transferring a call from the cellular phone to the system during a call.

Muting your voice

Press  (MUTE).

Inputting digits

Press  (0-9) and use the tune/scroll knob to input the desired digits.

- To send the input digits press  (SEND).
- When finished, press  (EXIT) to return to the previous screen.

Setting call volume

To decrease the volume: Turn the power/volume knob counter-clockwise.

To increase the volume: Turn the power/volume knob clockwise.

■ When talking on the phone

- Do not talk simultaneously with the other party.
- Keep the volume of the received voice down. Otherwise, voice echo will increase.

■ Automatic volume adjustment

When vehicle speed is 80 km/h (50 mph) or more, the volume automatically increases. The volume returns to the previous volume setting when vehicle speed drops to 70 km/h (43 mph) or less.

■ Phone call system functions

Depending on the cellular phone, certain functions may not be available.

■ Situations where the system may not recognize your voice

- When driving on a rough road
- When driving at high speeds
- When air is blowing out of the vents onto the microphone
- When the air conditioning fan emits a loud noise

Bluetooth®

■ When using the Bluetooth® audio/phone

- In the following situations, the system may not function.
 - The portable player does not support Bluetooth®
 - The cellular phone is located outside the service area
 - The Bluetooth® device is switched off
 - The Bluetooth® device has a low battery
 - The Bluetooth® device is not connected to the system
 - The Bluetooth® device is behind the seat or in the glove box or console box, or metal material covers or touches the device
- There may be a delay if a cellular phone connection is made during Bluetooth® audio play.
- Depending on the type of portable audio player that is connected to the system, operation may differ slightly and certain functions may not be available.

■ When transferring ownership of the vehicle

Be sure to initialize the system to prevent personal data from being improperly accessed. (→P. 435)

■ About Bluetooth®

The Bluetooth word mark and logos are registered trademarks owned by Bluetooth SIG, Inc. and any use of such marks by Fujitsu Ten Limited is under license. Other trademarks and trade names are those of their respective owners.



■ Compatible models

- Bluetooth® specifications:
Ver. 1.1, or higher (Recommended: Ver. 2.1 + EDR or higher)
- Following Profiles:
 - A2DP (Advanced Audio Distribution Profile) Ver. 1.0 or higher (recommended: Ver. 1.2 or higher)
 - AVRCP (Audio/Video Remote Control Profile) Ver. 1.0 or higher (recommended: Ver. 1.3 or higher)

Portable players must correspond to the above specifications in order to be connected to the Bluetooth® audio/phone. However, please note that some functions may be limited depending on the type of portable player.

- Cellular phone
 - HFP (Hands Free Profile) Ver. 1.0 or higher (Recommended: Ver. 1.5)
 - OPP (Object Push Profile) Ver. 1.1
 - PBAP (Phone Book Access Profile) Ver. 1.0

■ Certification



The latest "DECLARATION of CONFORMITY"(DoC) is available at the following:

DoC address: FUJITSU TEN LIMITED

2-28, Goshō-dori 1-chome, Hyogo-ku, Kobe, 652-8510, Japan

български [Bulgarian]	С настоящето, FUJITSU TEN LIMITED, декларира, че FT0052A е в съответствие със съществените изисквания и другите приложими разпоредби на Директива 1999/5/EC.
Česky [Czech]	FUJITSU TEN LIMITED tímto prohlašuje, že tento FT0052A je ve shodě se základními požadavky a dalšími příslušnými ustanoveními směrnice 1999/5/ES
[Croatia]	Ovim FUJITSU TEN LIMITED, izjavljuje da je FT0052A u skladu s bitnim zahtjevima drugim relevantnim odredbama Direktive 1999/5/EC i Pravilnika o RiTT opremi (NN 25/2012).
Dansk [Danish]	Undertegnede FUJITSU TEN LIMITED erklærer herved, at følgende udstyr FT0052A overholder de væsentlige krav og øvrige relevante krav i direktiv 1999/5/EF.
Deutsch [German]	Hiermit erklart FUJITSU TEN LIMITED, dass sich das Gerat FT0052A in Ubereinstimmung mit den grundlegenden Anforderungen und den ubrigen einschlagigen Bestimmungen der Richtlinie 1999/5/EG befindet.
Eesti [Estonian]	Kaesolevaga kinnitab FUJITSU TEN LIMITED seadme FT0052A vastavust direktiivi 1999/5/EU pohinõuetele ja nimetatud direktiivist tulenevatele teistele asjakohastele sätetele.
English	Hereby, FUJITSU TEN LIMITED, declares that this FT0052A is in compliance with the essential requirements and other relevant provisions of Directive 1999/5/EC.
Español [Spanish]	Por medio de la presente FUJITSU TEN LIMITED declara que el FT0052A cumple con los requisitos esenciales y cualesquiera otras disposiciones aplicables o exigibles de la Directiva 1999/5/CE.
Ελληνική [Greek]	ΜΕ ΤΗΝ ΠΑΡΟΥΣΑ FUJITSU TEN LIMITED ΔΗΛΩΝΕΙ ΟΤΙ FT0052Α ΣΥΜΜΟΡΦΩΝΕΤΑΙ ΠΡΟΣ ΤΙΣ ΟΥΣΙΩΔΕΙΣ ΑΠΑΙΤΗΣΕΙΣ ΚΑΙ ΤΙΣ ΛΟΙΠΕΣ ΣΧΕΤΙΚΕΣ ΔΙΑΤΑΞΕΙΣ ΤΗΣ ΟΔΗΓΙΑΣ 1999/5/ΕΚ.
Français [French]	Par la présente FUJITSU TEN LIMITED déclare que l'appareil FT0052A est conforme aux exigences essentielles et aux autres dispositions pertinentes de la directive 1999/5/CE.
Italiano [Italian]	Con la presente FUJITSU TEN LIMITED dichiara che questo FT0052A è conforme ai requisiti essenziali ed alle altre disposizioni pertinenti stabilite dalla direttiva 1999/5/CE.
Latviski [Latvian]	Ar šo FUJITSU TEN LIMITED deklarē, ka FT0052A atbilst Direktīvas 1999/5/EK būtiskajām prasībām un citiem ar to saistītajiem noteikumiem.
Lietuvių [Lithuanian]	Šiuo FUJITSU TEN LIMITED deklaruoja, kad šis FT0052A atitinka esminius reikalavimus ir kitas 1999/5/EB Direktyvos nuostatas.

Nederlands [Dutch]	Hierbij verklaart FUJITSU TEN LIMITED dat het toestel FT0052A in overeenstemming is met de essentiële eisen en de andere relevante bepalingen van richtlijn 1999/5/EG.
Malti [Maltese]	Hawnhekk, FUJITSU TEN LIMITED, jiddikjara li dan FT0052A jikkonforma mal-htigijiet essenzjali u ma provvedimenti oħrajn rilevanti li hemm fid-Dirrettiva 1999/5/EC.
Magyar [Hungarian]	Alulírott, FUJITSU TEN LIMITED nyilatkozom, hogy a FT0052A megfelel a vonatkozó alapvető követelményeknek és az 1999/5/EC irányelv egyéb előírásainak.
Polski [Polish]	Niniejszym FUJITSU TEN LIMITED oświadcza, że FT0052A jest zgodny z zasadniczymi wymogami oraz pozostałymi stosownymi postanowieniami Dyrektywy 1999/5/EC.
Português [Portuguese]	FUJITSU TEN LIMITED declara que este FT0052A está conforme com os requisitos essenciais e outras disposições da Directiva 1999/5/CE.
Română [Romanian]	Prin prezenta, FUJITSU TEN LIMITED, declară că aparatul FT0052A este în conformitate cu cerințele esențiale și cu alte prevederi pertinente ale Directivei 1999/5/CE.
Slovensko [Slovenian]	FUJITSU TEN LIMITED izjavlja, da je ta FT0052A v skladu z bistvenimi zahtevami in ostalimi relevantnimi določili direktive 1999/5/ES.
Slovensky [Slovak]	FUJITSU TEN LIMITED týmto vyhlasuje, že FT0052A spĺňa základné požiadavky a všetky príslušné ustanovenia Smernice 1999/5/ES.
Suomi [Finnish]	FUJITSU TEN LIMITED vakuuttaa täten että FT0052A tyyppinen laite on direktiivin 1999/5/EY oleellisten vaatimusten ja sitä koskevien direktiivin muiden ehtojen mukainen.
Svenska [Swedish]	Härmed intygar FUJITSU TEN LIMITED att denna FT0052A står i överensstämmelse med de väsentliga egenskapskrav och övriga relevanta bestämmelser som framgår av direktiv 1999/5/EG.
Íslenska [Icelandic]	Hér með lýsir FUJITSU TEN LIMITED yfir því að FT0052A er í samræmi við grunnkröfur og aðrar kröfur, sem gerðar eru í tilskipun 1999/5/EC.
Norsk [Norwegian]	FUJITSU TEN LIMITED erklærer herved at utstyre FT0052A er i samsvar med de grunnleggende krav og øvrige relevante krav i direktiv 1999/5/EF.
[Montenegro]	Ovim , FUJITSU TEN LIMITED, izjavljuje da ovaj FT0052A je usklađen sa bitnim zahtjevima i drugim relevantnim odredbama Direktive 1999/5/EC.

 CAUTION**■ While driving**

Do not use the portable audio player, cellular phone or connect a device to the Bluetooth® system.

■ Caution regarding interference with electronic devices

- Your audio unit is fitted with Bluetooth® antennas. People with implanted pacemakers or cardiac defibrillators should maintain a reasonable distance between themselves and the Bluetooth® antennas. The radio waves may affect the operation of such devices.
- Before using Bluetooth® devices, users of any electrical medical device other than implanted pacemakers and implanted cardiac defibrillators should consult the manufacturer of the device for information about its operation under the influence of radio waves. Radio waves could have unexpected effects on the operation of such medical devices.

 NOTICE**■ When leaving the vehicle**

Do not leave portable audio player or cellular phone in the vehicle. The inside of the vehicle may become hot, causing damage to the portable audio player or cellular phone.

Interior features

6

- 6-1. Using the air conditioning system and defogger**
 - Front manual air conditioning system 452
 - Front automatic air conditioning system 458
 - Rear manual air conditioning system 467
 - Rear automatic air conditioning system 469
 - Heated steering wheel/seat heaters 472
- 6-2. Using the interior lights**
 - Interior lights list 476
 - Personal/interior lights main switch 477
 - Personal/interior lights ... 477
 - Lounge illumination control switches 478
- 6-3. Using the storage features**
 - List of storage features 480
 - Glove box 481
 - Card holder 482
 - Console box 482
 - Cup holders/bottle holders/door pockets 484
 - Auxiliary boxes 487
 - Luggage compartment features 489
- 6-4. Using the other interior features**
 - Other interior features 493
 - Cool box 493
 - Sun visors 495
 - Vanity mirror 495
 - Conversation mirror 496
 - Clock 497
 - Power outlet 498
 - Armrest 501
 - Coat hooks 501
 - Assist grips 502
 - Ashtray 503

Front manual air conditioning system*

The illustration below is for left-hand drive vehicles.
The button positions and shapes may differ slightly for right-hand drive vehicles.

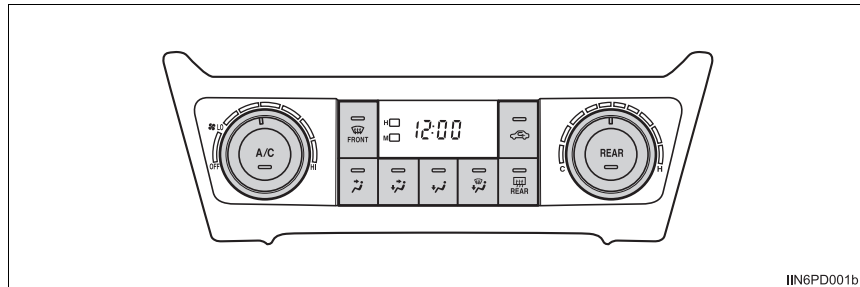

IIN6PD001b

■ Adjusting the temperature setting

Turn  clockwise (warm) or counterclockwise (cool).

Vehicles with the “A/C” button: If the “A/C” button is not pressed, the system will blow ambient temperature air or heated air.

■ Adjusting the fan speed setting

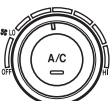
Turn  clockwise (increase) or counterclockwise (decrease).

Turning the knob to “OFF” turns off the fan.

■ Changing the air flow mode

Press any button of , ,  or .

*: If equipped

Other functions

■ Switching between outside air and recirculated air modes

Press .

The mode switches between outside air mode (indicator off) and recirculated air mode (indicator on) each time the button is pressed.

■ Defogging the windshield

Defoggers are used to defog the windshield and front side windows.

Press .

Set the outside/recirculated air mode button to outside air mode if the recirculated air mode is used. (It may switch automatically.)

To defog the windshield and the side windows early, turn the air flow and temperature up.

To return to the previous mode, press  again when the windshield is defogged.

Vehicles with the “A/C” button: If the dehumidification function is not operating, press to operate the dehumidification function.

■ Defogging the rear window and outside rear view mirrors

- ▶ Vehicles without outside rear view mirror defoggers

Defoggers are used to defog the rear window.

- ▶ Vehicles with outside rear view mirror defoggers

Defoggers are used to defog the rear window, and to remove rain-drops, dew and frost from the outside rear view mirrors.

Press .

The defoggers will automatically turn off after a period of time.

■ **Windshield wiper de-icer (if equipped)**

This feature is used to prevent ice from building up on the windshield and wiper blades.

Turns on/off

The windshield wiper de-icer will automatically turn off after a period of time.

▶ Left-hand drive vehicles

▶ Right-hand drive vehicles

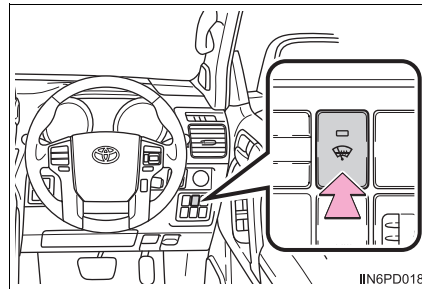
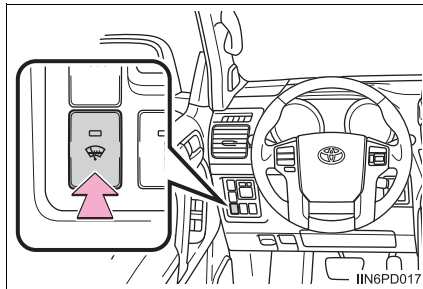

■ **Heater idle up (if equipped)**

This feature is used to boost heating effect in extremely cold conditions when the vehicle is not moving.

Press the switch to increase engine speed.

Press the switch again to return the engine to the normal idle speed. If you do not turn the switch to off, the engine speed is increased whenever the engine is started.

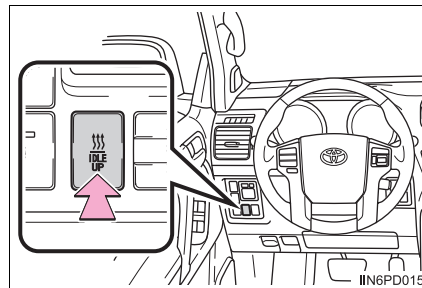

■ Power heater (if equipped)

This feature is used to heat the engine coolant, speed up warming of the cab in cold weather, and keep the cab warm.

Turns the power heater on/off

If you do not turn the switch to off, the engine speed is increased whenever the engine is started.

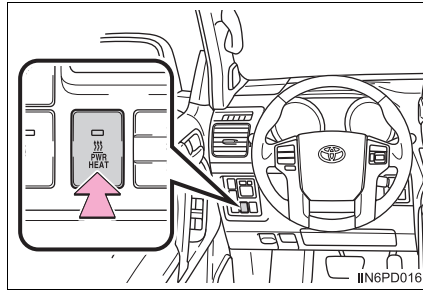

Air outlets

■ Location of air outlets

The air outlets and air volume changes according to the selected air flow mode.

← : Some models

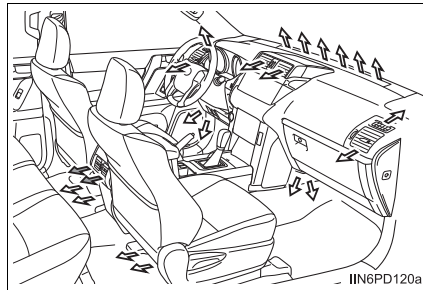

■ Adjusting the position of and opening and closing the air outlets

▶ Front outlets

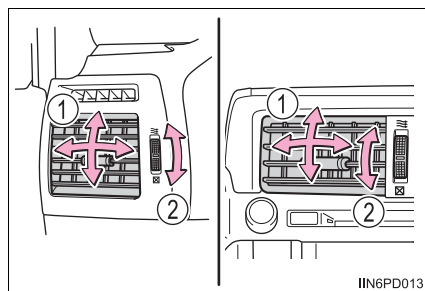

▶ Rear outlets*

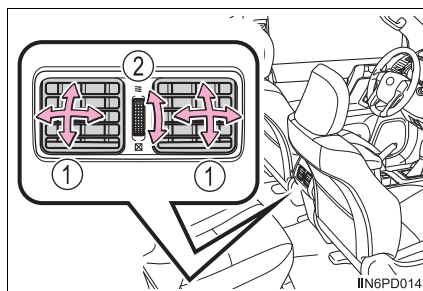

① Direct air flow to the left or right, up or down.

② Turn the knob to open or close the vent.

*: Vehicles without rear manual air conditioning system

■ **Fogging up of the windows**

- Vehicles with the “A/C” button: The windows will easily fog up when the humidity in the vehicle is high. Turning the “A/C” button on will dehumidify the air from the outlets and defog the windshield effectively.
- Vehicles with the “A/C” button: If you turn the “A/C” button off, the windows may fog up more easily.
- The windows may fog up if the recirculated air mode is used.

■ **Outside/recirculated air mode**

When driving on dusty roads such as tunnels or in heavy traffic, set the outside/recirculated air mode button to the recirculated air mode. This is effective in preventing outside air from entering the vehicle interior. During cooling operation, setting the recirculated air mode will also cool the vehicle interior effectively.

■ **When outside air temperature is low (vehicles with the “A/C” button)**

The cooling and dehumidification function may not operate even when the “A/C” button is pressed.

■ **Air conditioning odors**

- During use, various odors from inside and outside the vehicle may enter into and accumulate in the air conditioning system. This may then cause odor to be emitted from the vents.
- To reduce potential odors from occurring:
It is recommended that the air conditioning system be set to outside air mode prior to turning the vehicle off.

■ **Air conditioning filter**

→P. 557

 CAUTION

■ **To prevent the windshield from fogging up**

- Do not use  during cool air operation in extremely humid weather. The difference between the temperature of the outside air and that of the windshield can cause the outer surface of the windshield to fog up, blocking your vision.
- Do not place anything on the instrument panel which may cover the air outlets. Otherwise, air flow may be obstructed, preventing the windshield defoggers from defogging.

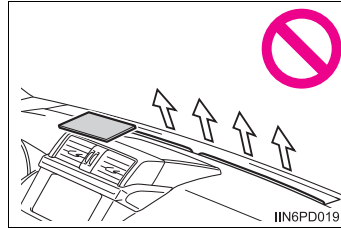

■ **To prevent burns**

- Do not touch the rear view mirror surfaces when the outside rear view mirror defoggers are on. (vehicles with outside rear view mirror defoggers)
- Do not touch the glass at lower part of the windshield or to the side of the front pillars when the windshield wiper de-icer is on. (vehicles with windshield wiper de-icer)

 NOTICE

■ **To prevent battery discharge**

Do not leave the air conditioning system on longer than necessary when the engine is off.

Front automatic air conditioning system*

Air outlets and fan speed are automatically adjusted according to the temperature setting.

The illustration below is for left-hand drive vehicles. The button positions and shapes may differ slightly for right-hand drive vehicles.

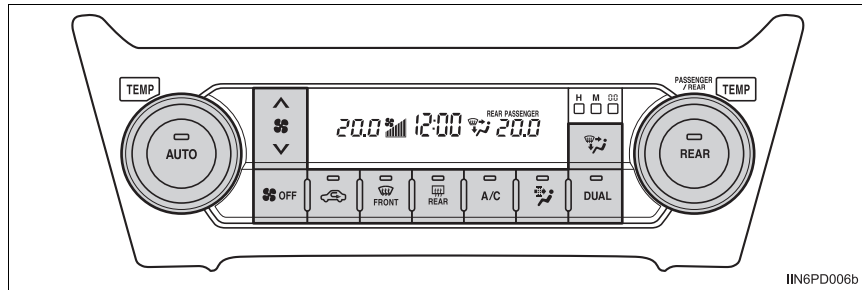

■ Adjusting the temperature setting

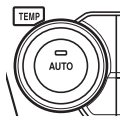
Turn  clockwise to increase the temperature and turn the knob counterclockwise to decrease the temperature.

■ Adjusting the fan speed setting

Press “^” on  to increase the fan speed and “v” to decrease the fan speed.

Press the “OFF” button to turn the fan off.

■ Changing the air flow mode

Press .

The air flow mode switch each time the button is pressed.

*: If equipped

Air conditioning controls

■ Using the automatic mode

- 1 Press the “AUTO” button.
- 2 Adjust the temperature setting.
- 3 To stop the operation, press the “OFF” button.

■ If the system is operated manually in automatic mode

If the fan speed setting or air flow modes are operated, the automatic mode indicator goes off. However, automatic mode for functions other than that operated are maintained.

■ Adjusting the temperature for driver and passenger seats separately (“DUAL” mode)

To turn on the “DUAL” mode, perform any of the following procedures:

- Press the “DUAL” button.
- Adjust the passenger’s side temperature setting.

The indicator comes on when the “DUAL” mode is on.

While in “DUAL” mode, the temperature of the rear air outlets is set at the passenger’s side temperature setting.

Changing the rear seat settings (vehicles with rear automatic air conditioning system)

■ **Adjusting the temperature setting**

- 1 Press the “REAR” button.
“REAR” is shown on the display.

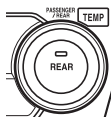
- 2 Turn  clockwise to increase the temperature and turn the knob counterclockwise to decrease the temperature.

■ **Adjusting the fan speed setting**

Press “^” on  to increase the fan speed and “v” to decrease the fan speed.

Press the “OFF” button to turn the fan off.

■ **Changing the air flow mode**

Press .

The air flow mode switch each time the button is pressed.

Other functions

■ Switching between outside air and recirculated air modes

Press .

The mode switches between outside air mode (indicator off) and recirculated air mode (indicator on) each time the button is pressed.

■ Defogging the windshield

Defoggers are used to defog the windshield and front side windows.

Press .

Set the outside/recirculated air mode button to outside air mode if the recirculated air mode is used. (It may switch automatically.)

To defog the windshield and the side windows early, turn the air flow and temperature up.

To return to the previous mode, press  again when the windshield is defogged.

■ Defogging the rear window and outside rear view mirrors

- ▶ Vehicles without outside rear view mirror defoggers

Defoggers are used to defog the rear window.

- ▶ Vehicles with outside rear view mirror defoggers

Defoggers are used to defog the rear window, and to remove rain-drops, dew and frost from the outside rear view mirrors.

Press .

The defoggers will automatically turn off after a period of time.

■ **Pollen removal mode**

Pollen is removed from the air and the air flows to the upper part of the body.

Press  .

In order to prevent the windshield from fogging up when the outside air is cold, the dehumidification function may operate.

The pollens are filtered out even if the pollen removal mode is turned off.

■ **Windshield wiper de-icer (if equipped)**

This feature is used to prevent ice from building up on the windshield and wiper blades.

Turns on/off

The windshield wiper de-icer will automatically turn off after a period of time.

▶ Left-hand drive vehicles

▶ Right-hand drive vehicles

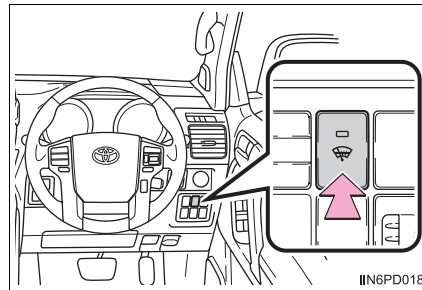
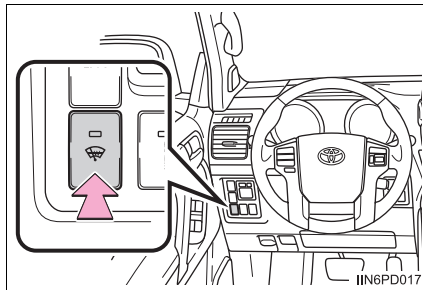

■ Heater idle up (if equipped)

This feature is used to boost heating effect in extremely cold conditions when the vehicle is not moving.

Press the switch to increase engine speed.

Press the switch again to return the engine to the normal idle speed. If you do not turn the switch to off, the engine speed is increased whenever the engine is started.

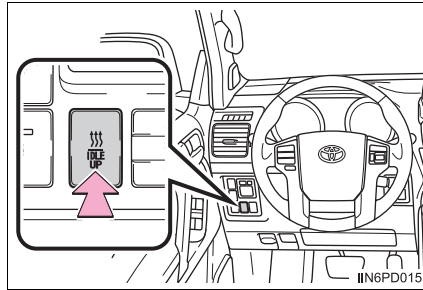
**■ Power heater (if equipped)**

This feature is used to heat the engine coolant, speed up warming of the cab in cold weather, and keep the cab warm.

Turns the power heater on/off

If you do not turn the switch to off, the engine speed is increased whenever the engine is started.

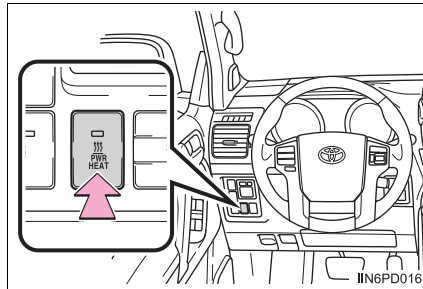

Air outlets

■ Location of air outlets

The air outlets and air volume changes according to the selected air flow mode.

← : Some models

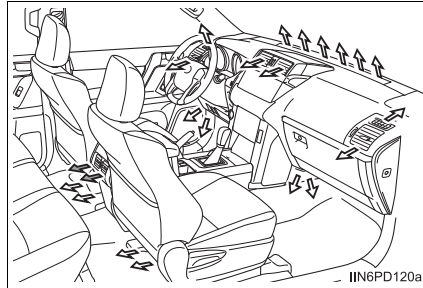

■ Adjusting the position of and opening and closing the air outlets

► Front outlets

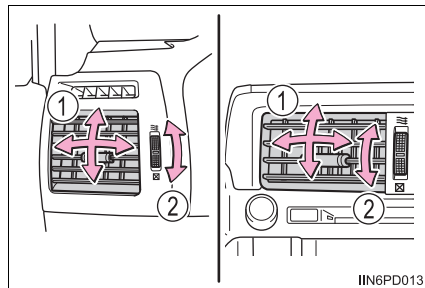

► Rear outlets*

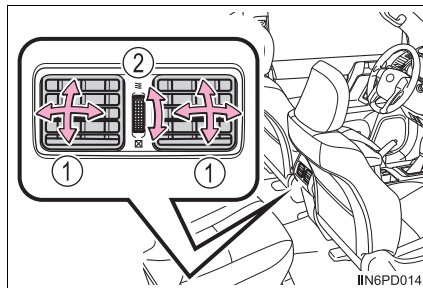

① Direct air flow to the left or right, up or down.

② Turn the knob to open or close the vent.

*: Vehicles without rear automatic air conditioning system

■ Using automatic mode

Fan speed is adjusted automatically according to the temperature setting and ambient conditions.

Therefore, the fan may stop for a while until warm or cool air is ready to flow immediately after the "AUTO" button is pressed.

■ Fogging up of the windows

- The windows will easily fog up when the humidity in the vehicle is high. Turning the "A/C" button on will dehumidify the air from the outlets and defog the windshield effectively.
- If you turn the "A/C" button off, the windows may fog up more easily.
- The windows may fog up if the recirculated air mode is used.

■ Outside/recirculated air mode

- When driving on dusty roads such as tunnels or in heavy traffic, set the outside/recirculated air mode button to the recirculated air mode. This is effective in preventing outside air from entering the vehicle interior. During cooling operation, setting the recirculated air mode will also cool the vehicle interior effectively.
- Outside/recirculated air mode may automatically switch depending on the temperature setting or the inside temperature.

■ When outside air temperature is low

The cooling and dehumidification function may not operate even when the "A/C" button is pressed.

■ Using the rear automatic air conditioning system (vehicles with rear automatic air conditioning system)

- When the rear automatic air conditioning system is on, the indicator light on the "REAR" button is turned on.
- If the system is left untouched for approximately 10 seconds after changing to the rear automatic air conditioning system, the control mode in the front control panel returns to the front.

■ Air conditioning odors

- During use, various odors from inside and outside the vehicle may enter into and accumulate in the air conditioning system. This may then cause odor to be emitted from the vents.
- To reduce potential odors from occurring:
 - It is recommended that the air conditioning system be set to outside air mode prior to turning the vehicle off.
 - The start timing of the blower may be delayed for a short period of time immediately after the air conditioning system is started in automatic mode.

■ **Air conditioning filter**

→P. 557

■ **Customization**

Settings (e.g. A/C automatic mode button operation) can be changed.
(Customizable features →P. 705)

 **CAUTION**

■ **To prevent the windshield from fogging up**

- Do not use  during cool air operation in extremely humid weather. The difference between the temperature of the outside air and that of the windshield can cause the outer surface of the windshield to fog up, blocking your vision.
- Do not place anything on the instrument panel which may cover the air outlets. Otherwise, air flow may be obstructed, preventing the windshield defoggers from defogging.

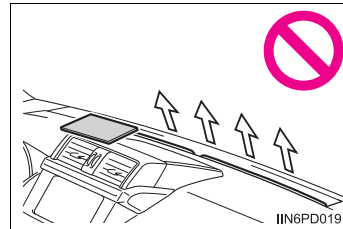

■ **To prevent burns**

- Do not touch the rear view mirror surfaces when the outside rear view mirror defoggers are on. (vehicles with outside rear view mirror defoggers)
- Do not touch the glass at lower part of the windshield or to the side of the front pillars when the windshield wiper de-icer is on. (vehicles with windshield wiper de-icer)

 **NOTICE**

■ **To prevent battery discharge**

Do not leave the air conditioning system on longer than necessary when the engine is off.

Rear manual air conditioning system*

Press the “REAR” button on the front manual air conditioning control panel to use the rear manual air conditioning system.

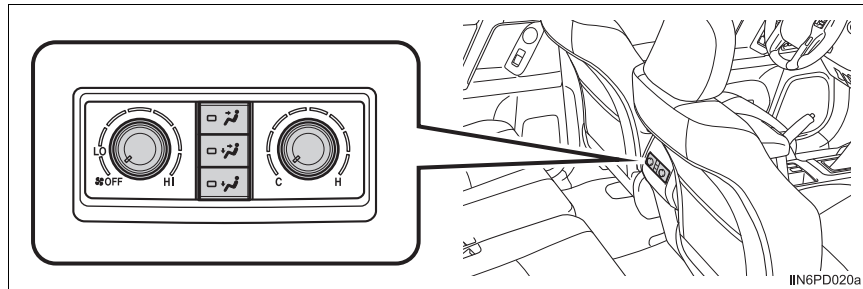

■ Adjusting the temperature setting

Turn  clockwise (warm) or counterclockwise (cool).

■ Adjusting the fan speed setting

Turn  clockwise (increase) or counterclockwise (decrease).

Turning the knob to “OFF” turns off the fan.

■ Changing the air flow mode

Press any button of ,  or .

*: If equipped

Air outlets

■ Location of air outlets

The air outlets and air volume changes according to the selected air flow mode.

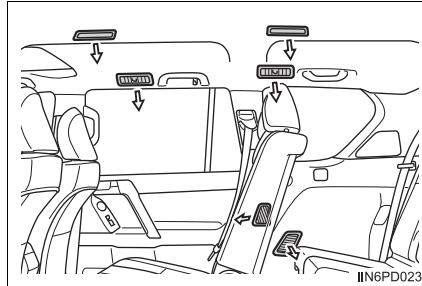

■ Adjusting the position of and opening and closing the air outlets

- ① Direct air flow to the left or right, up or down.
- ② Turn the knob fully to the back of the vehicle to close the vent.

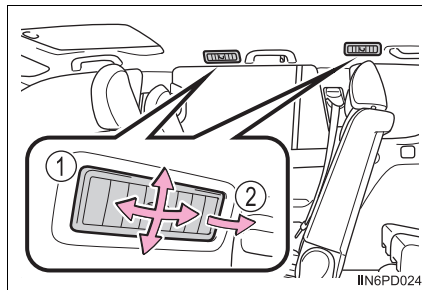

⚠ NOTICE

■ To prevent battery discharge

Do not leave the air conditioning system on longer than necessary when the engine is off.

Rear automatic air conditioning system*

Air outlets and fan speed are automatically adjusted according to the temperature setting.

- ▶ Vehicles without outer second seat heaters

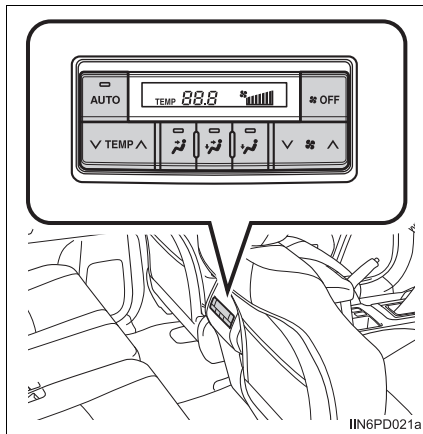

- ▶ Vehicles with outer second seat heaters

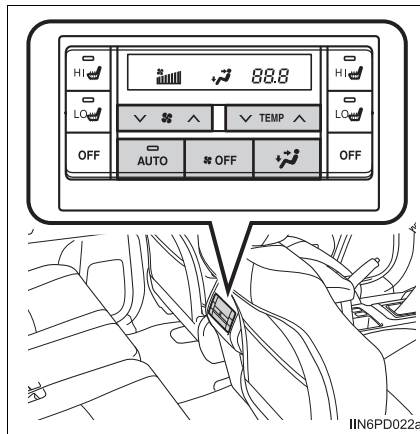

■ Adjusting the temperature setting

Press “^” on the “TEMP” button to increase the temperature and “v” to decrease the temperature.



■ Adjusting the fan speed setting

Press “^” on  to increase the fan speed and “v” to decrease the fan speed.

Press the “OFF” button to turn the fan off.

■ Changing the air flow mode

- ▶ Vehicles without outer second seat heaters

Press any button of ,  or .

- ▶ Vehicles with outer second seat heaters

Press .

The air flow mode switch each time the button is pressed.

*: If equipped

Air conditioning controls

- **Using the automatic mode**

- ① Press the “AUTO” button.
- ② Adjust the temperature setting.
- ③ To stop the operation, press the “OFF” button.

- **If the system is operated manually in automatic mode**

If the fan speed setting or air flow modes are operated, the automatic mode indicator goes off. However, automatic mode for functions other than that operated are maintained.

Air outlets

- **Location of air outlets**

The air outlets and air volume changes according to the selected air flow mode.

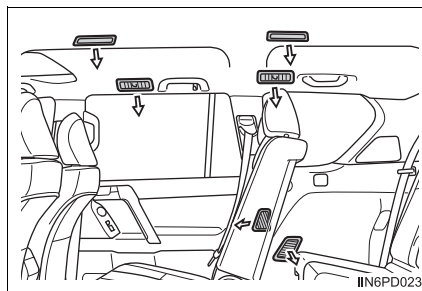

- **Adjusting the position of and opening and closing the air outlets**

- ① Direct air flow to the left or right, up or down.
- ② Turn the knob fully to the back of the vehicle to close the vent.

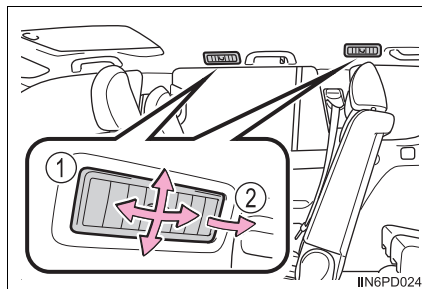



NOTICE

■ **To prevent battery discharge**

Do not leave the air conditioning system on longer than necessary when the engine is off.

Heated steering wheel*/seat heaters*

Heated steering wheel and seat heaters heat the side grips of the steering wheel and seats.

CAUTION

- Care should be taken to prevent injury if anyone in the following categories comes in contact with the steering wheel and seats when the heater is on:
 - Babies, small children, the elderly, the sick and the physically challenged
 - Persons with sensitive skin
 - Persons who are fatigued
 - Persons who have taken alcohol or drugs that induce sleep (sleeping drugs, cold remedies, etc.)
- Observe the following precautions to prevent the minor burns or overheating:
 - Do not cover the seat with a blanket or cushion when using the seat heater.
 - Do not use seat heater more than necessary.

NOTICE

- Do not put heavy objects that have an uneven surface on the seat and do not stick sharp objects (needles, nails, etc.) into the seat.
- To prevent battery discharge, do not use the functions when the engine is off.

*: If equipped

Heated steering wheel (if equipped)

Turns the steering wheel heater on/off

The indicator light comes on when the heater is operating.

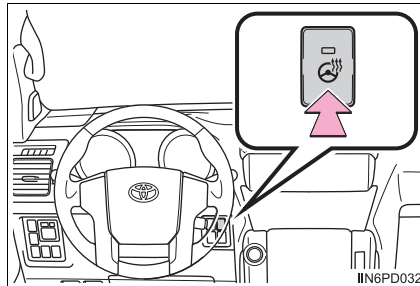
**■ The heated steering wheel can be used when**

- ▶ Vehicles without a smart entry & start system

The engine switch is in the "ON" position.

- ▶ Vehicles with a smart entry & start system

The engine switch is in IGNITION ON mode.

■ Timer

The heated steering wheel will automatically turn off after about 30 minutes.

Seat heaters (if equipped)

■ Front seats

▶ Vehicles with an automatic transmission

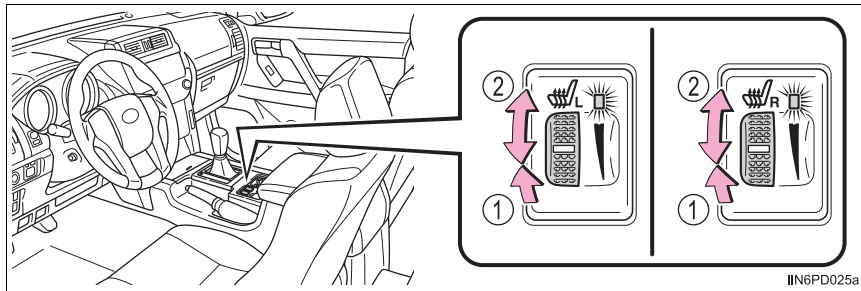

▶ Vehicles with a manual transmission

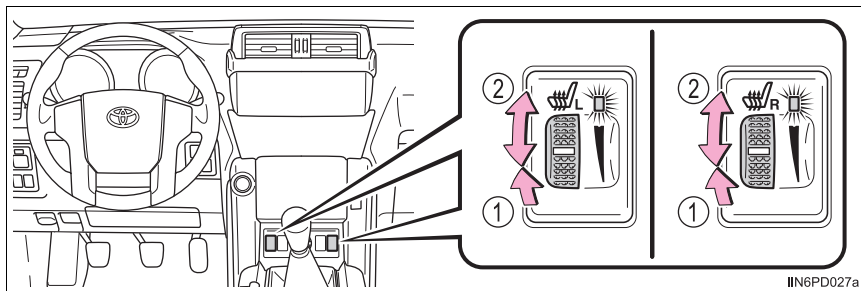

- ① Turns the seat heater on
The indicator light comes on.
- ② Adjusts the seat temperature
The further you turn the dial upward, the warmer the seat becomes.

■ Outer second seat heaters

- ① For left second seat
- ② For right second seat
- ③ High heating temperature
- ④ Low heating temperature

To turn on the seat heater, press
“HI” or “LO”.

- ⑤ Off

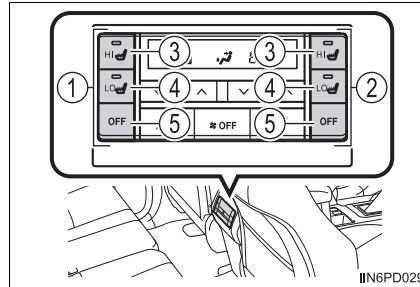
**■ The seat heaters can be used when**

- ▶ Vehicles without a smart entry & start system

The engine switch is in the “ON” position.

- ▶ Vehicles with a smart entry & start system

The engine switch is in IGNITION ON mode.

Interior lights list

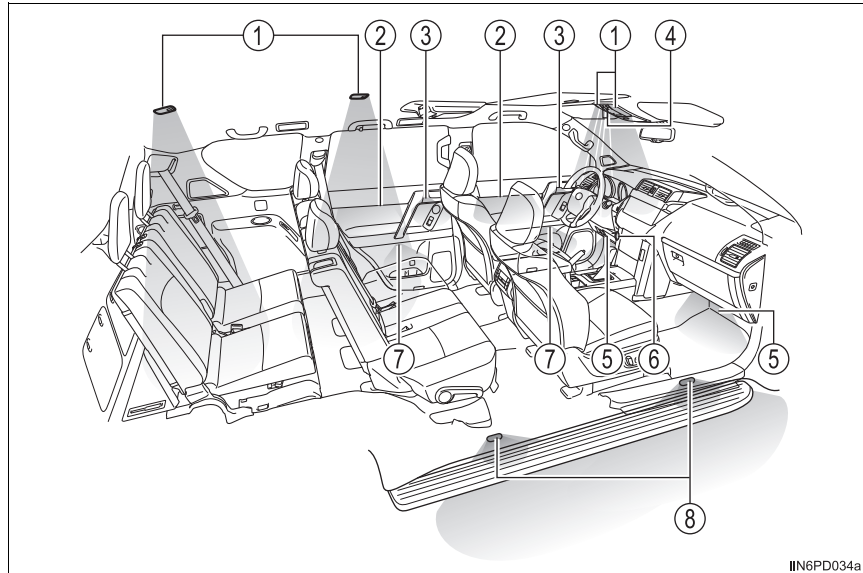

- ① Personal/interior lights (→P. 478)
- ② Ornament illumination* (if equipped)
- ③ Inside door handle lights* (if equipped)
- ④ Shift lever light
- ⑤ Footwell lights* (if equipped)
- ⑥ Engine switch light
- ⑦ Door pocket lights* (if equipped)
- ⑧ Running board lights (if equipped)

*: The brightness of the lights can be adjusted (→P. 479)

Personal/interior lights main switch

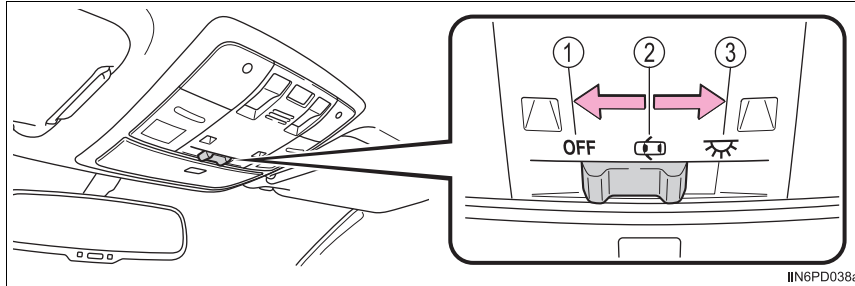

- ① Off
The personal/interior lights and interior light can be individually turned on or off.
- ② Door position
The personal/interior lights come on when a door is opened. They turn off when the doors are closed.
- ③ On
The personal/interior lights cannot be individually turned off.

Personal/interior lights

► Front

Turns the lights on/off

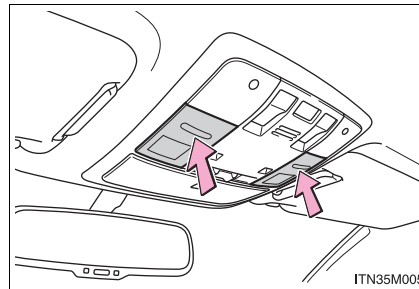

► Rear (without personal lights)

① Turns the lights on

② Turns the door position on

Door position: When the personal/interior light main switch is in the "OFF" position, the lights will not turn on.

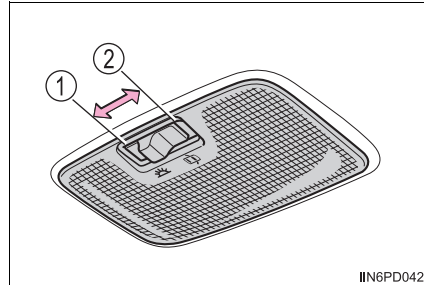

► Rear (with personal lights)

Turns the lights on/off

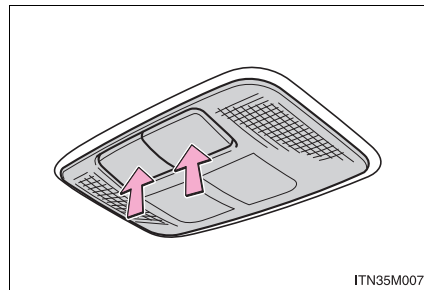

Lounge illumination control switches (if equipped)

The brightness of the following lights can be adjusted:

- Inside door handle lights
- Ornament illumination
- Door pocket lights
- Footwell lights

① Brighter

② Darker

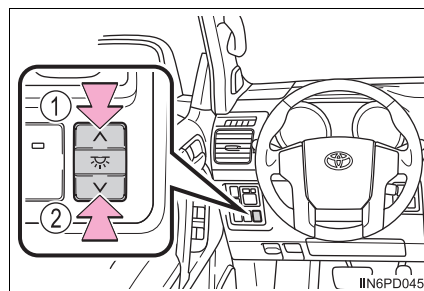

■ Illuminated entry system

- ▶ Vehicles without a smart entry & start system

The lights automatically turn on/off according to the engine switch position, whether the doors are locked/unlocked, and whether the doors are open/closed.

- ▶ Vehicles with a smart entry & start system

The lights automatically turn on/off according to the engine switch mode, the presence of the electronic key, whether the doors are locked/unlocked, and whether the doors are open/closed.

■ To prevent battery discharge

If the following lights remain on when the engine switch is turned off the lights will go off automatically after 20 minutes:

- Personal/interior light
- Inside door handle lights (if equipped)
- Ornament illumination (if equipped)
- Door pocket lights (if equipped)
- Footwell lights (if equipped)

■ Customization

Settings (e.g. time elapsed before the interior lights turn off) can be changed. (Customizable features →P. 709)

 **NOTICE**

To prevent battery discharge, do not leave the lights on longer than necessary when the engine is not running.

List of storage features

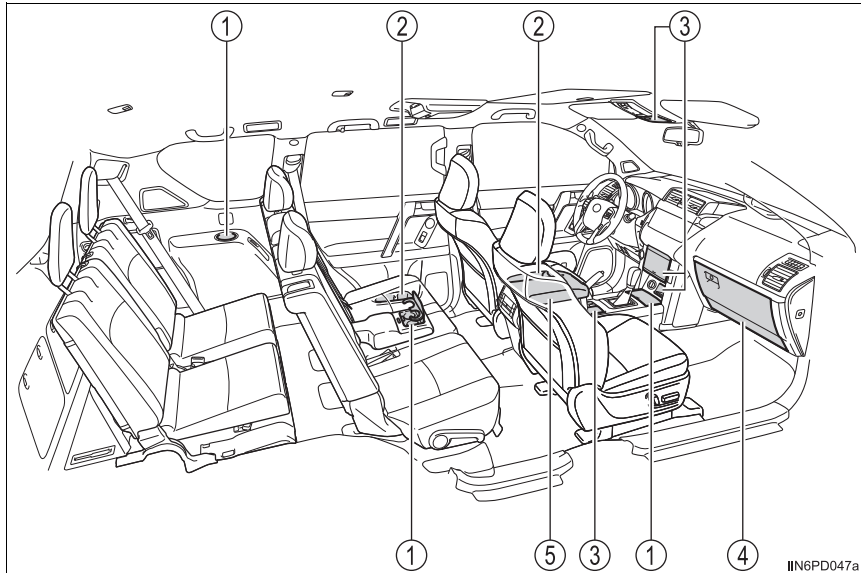

- ① Cup holders (→P. 485)
- ② Bottle holders/door pockets (→P. 486)
- ③ Auxiliary boxes (→P. 488)
- ④ Glove box (→P. 482)
Card holder (right-hand drive vehicles) (→P. 483)
- ⑤ Console box (if equipped) (→P. 483)
Cool box (if equipped) (→P. 493)

⚠ CAUTION

- Do not leave glasses, lighters or spray cans in the storage spaces, as this may cause the following when cabin temperature becomes high:
 - Glasses may be deformed by heat or cracked if they come into contact with other stored items.
 - Lighters or spray cans may explode. If they come into contact with other stored items, the lighter may catch fire or the spray can may release gas, causing a fire hazard.
- Keep the storage compartments lids closed when driving or not in use. In the event of sudden braking or sudden swerving, an accident may occur due to an occupant being struck by an open lid or the items stored inside.

Glove box

- ① Unlock with the master key or the mechanical key
- ② Lock with the master key or the mechanical key
- ③ Open (pull the lever)

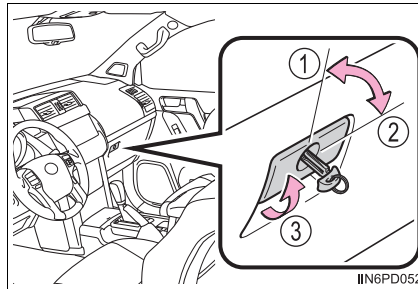

The glove box light turns on when the tail lights are on.

Card holder (right-hand drive vehicles)

The card holder is located in the glove box.

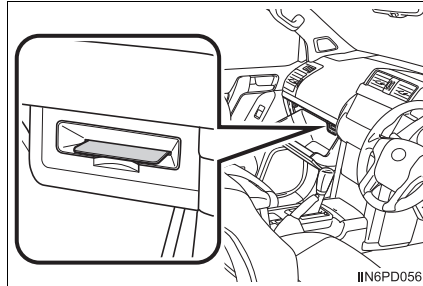

Console box (if equipped)

Your vehicle is equipped with either a console box or cool box.

For vehicles with the cool box, refer to P. 493.

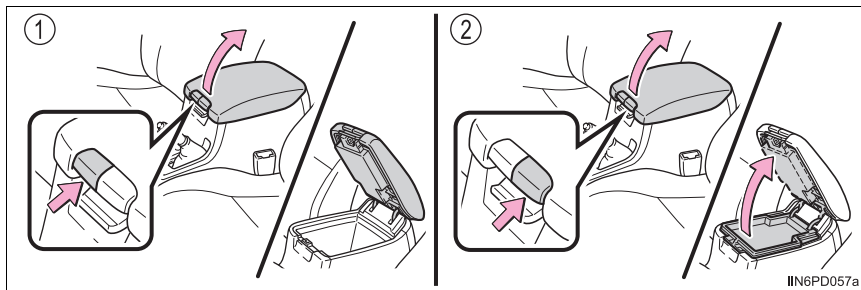

Lift the lid while pulling up the knob to release the lock.

- ① Lifts the lid and tray
- ② Lifts the lid
Pull the tray up to open the console box.

■ Using the console box vent (if equipped)

Air from the air conditioner can be distributed into the console box by opening and closing the vent.

- ① Open
- ② Close

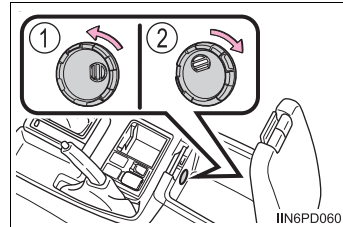
**■ Items unsuitable for the console box**

- Drinks in unsealed containers
- Fragile items, perishables or anything with strong odor
- Owner's manual, electronic devices, CDs, etc. (when using the console box vent)

■ When using the console box lid as an armrest

Slide the console box lid forward or backward as needed. Slide the lid while pulling up the lever to release the lock.

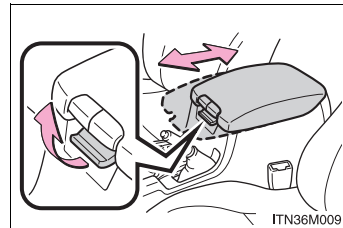
 **NOTICE**

Do not insert items exceeding the height of the tray. Doing so may prevent opening and closing of the lid.

Cup holders/bottle holders/door pockets

■ Cup holders

- ▶ Front (vehicles with an automatic transmission)

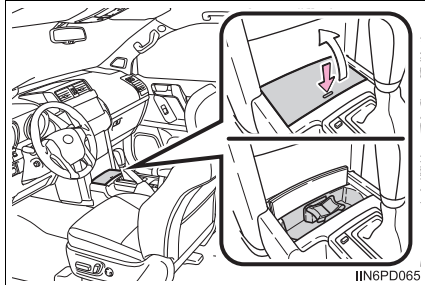

Press down and release the cup holder lid.

- ▶ Rear (type A) (if equipped)

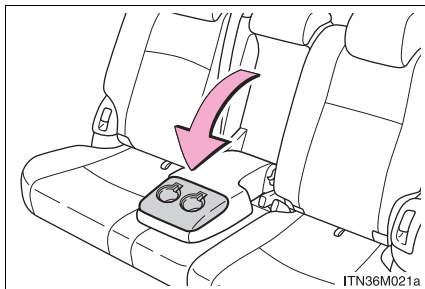

Pull the armrest down.

- ▶ Front (vehicles with a manual transmission)

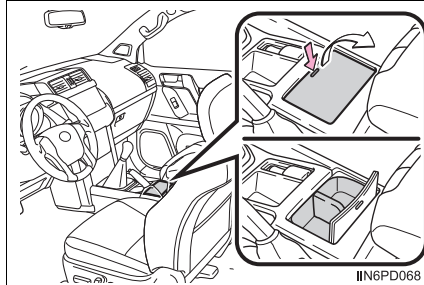

Press down and release the cup holder lid.

- ▶ Rear (type B) (if equipped)

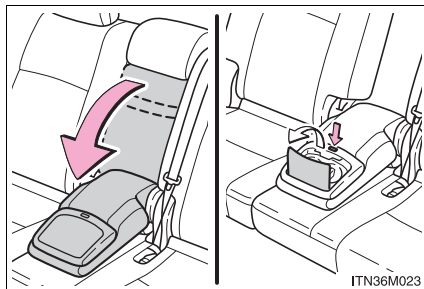

Pull the armrest down and press in and release the button.

▶ Rear (type C) (if equipped)

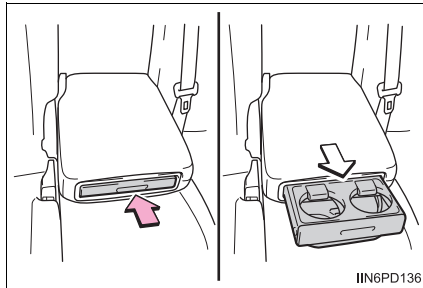

Push the lid.

▶ Rear (type D) (if equipped)

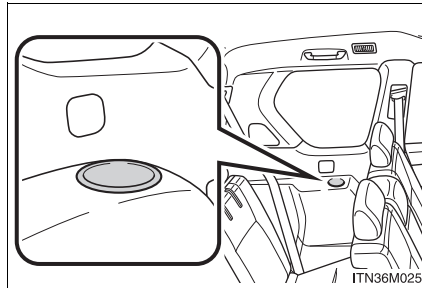
■ **Bottle holders/door pockets**

▶ Front

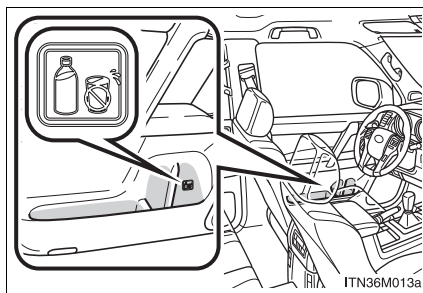

▶ Rear (if equipped)

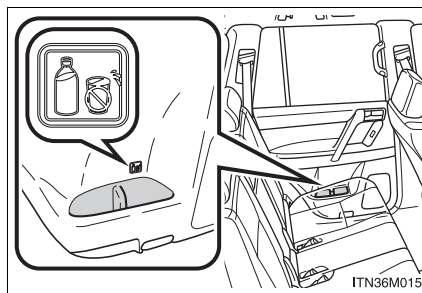
■ **Removing the holder, separate tray and adapter of the cup holder**

▶ Front (vehicles with an automatic transmission)

Pull up the holder.

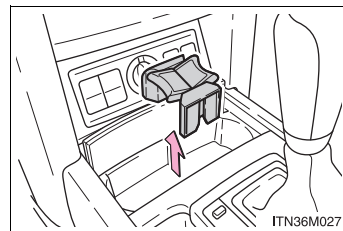

► Front (vehicles with a manual transmission)

Pull up the separate tray.

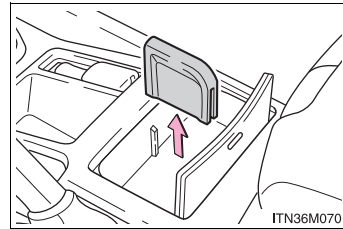

► Rear (type A)

Pull up the adapter.

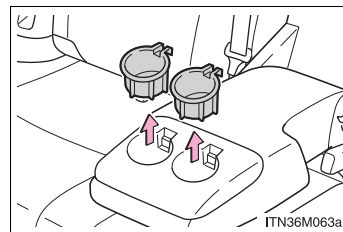

■ **When storing a bottle in the bottle holder**

- Close the cap.
- The bottle may not be stored depending on its size or shape.

⚠ CAUTION

■ **Items unsuitable for the cup holder**

Do not place anything other than cups, mugs or beverage cans in the cup holders.

Other items may be thrown out of the holders in the event of sudden braking, sudden swerving or an accident, cause injury. If possible, cover hot drinks to prevent burns.

■ **Items unsuitable for the bottle holder**

Do not place anything other than a bottle in the bottle holders.

Other items may be thrown out of the holders in the event of an accident or sudden braking and cause injury.

⚠ NOTICE

■ **To prevent damage to the rear cup holders (rear [type B])**

Stow the cup holders before stowing the armrest.

■ **Items that should not be stowed in the bottle holders**

Do not place open bottles in the bottle holders, or glasses and paper cups containing liquid. The contents may spill and glasses may break.

Auxiliary boxes

► Type A

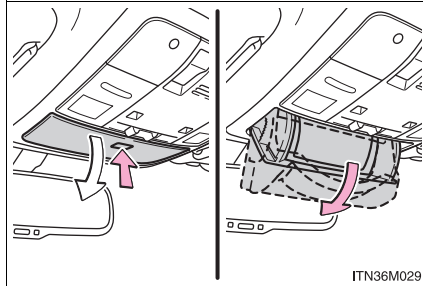

Press in the lid.

The auxiliary box is useful for temporarily storing sunglasses and similar small items.

► Type B (if equipped)

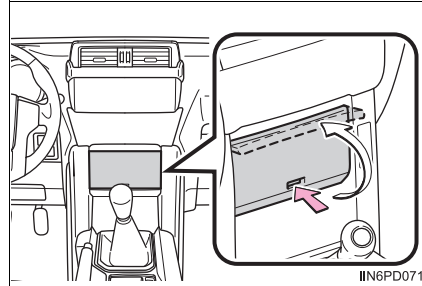

Push the lid.

► Type C (if equipped)

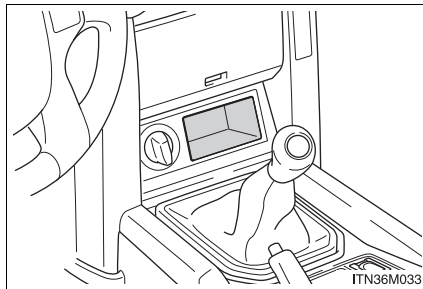

► Type D (if equipped)

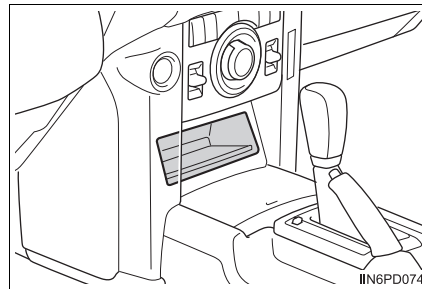

▶ Type E (vehicles with an automatic transmission)

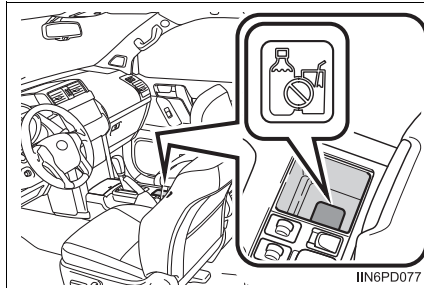

▶ Type F (vehicles with a manual transmission)

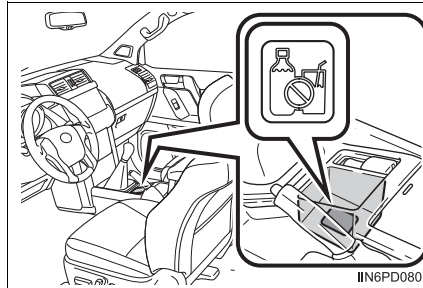

⚠ CAUTION

- Do not place cups, beverage cans or bottles in the box. They may be thrown out of the box in the event of sudden braking, sudden swerving or an accident, resulting in injury. (type E and F)
- Do not store items heavier than 0.2 kg (0.4 lb.). Doing so may cause the auxiliary box to open and the items inside may fall out, resulting in an accident. (type A)
- Do not put large items in the overhead console. The overhead console may not be able to be shut from the conversation mirror state. (type A)

Luggage compartment features

Deck rail (if equipped)

To attach the deck hooks, use the deck rails.

The deck hook itself is not included as an original equipment.

Vehicles with the third seats (power seat): When using the deck rail, the third seat must be fold down. (→P. 184)

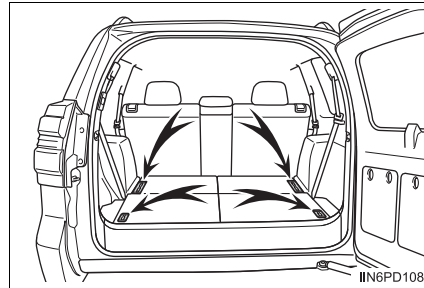

Cargo hooks (if equipped)

Raise the hook to use.

The cargo hooks are provided for securing loose items.

Vehicles with the third seats (manual seat): When using the deck hooks, the third seat must be fold down. (→P. 182)

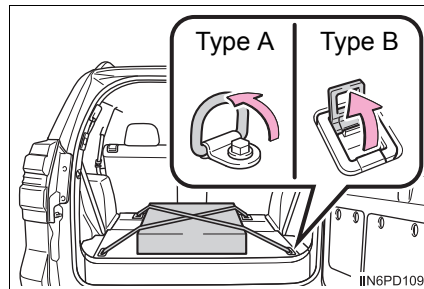

Warning reflector holder

- 1 Open the cover.
 - ① Turn the knob clockwise.
 - ② Open the cover.

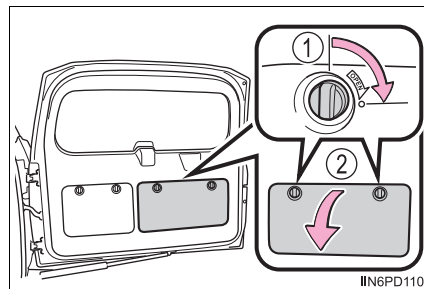

- 2 Secure the warning reflector.
The warning reflector itself is not included as an original equipment.

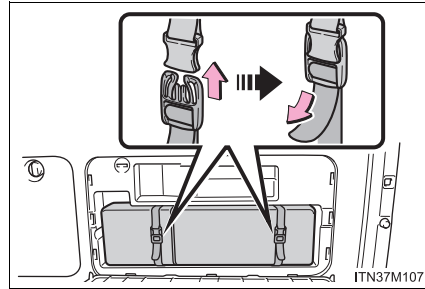

Cargo net hooks

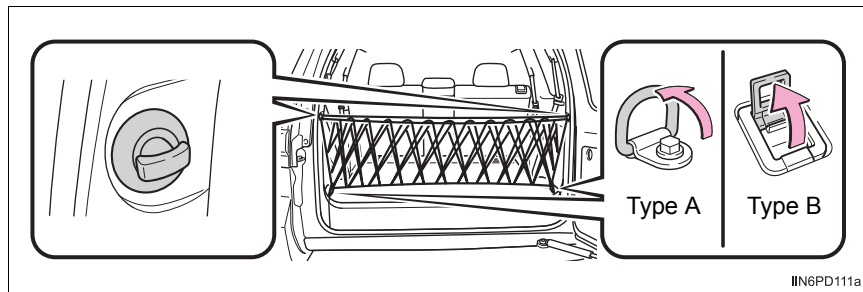

To hang the cargo net, use the cargo net hooks.
The cargo net itself is not included as an original equipment.

Auxiliary box (if equipped)

► Type A

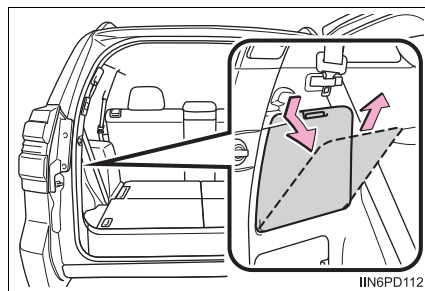

► Type B

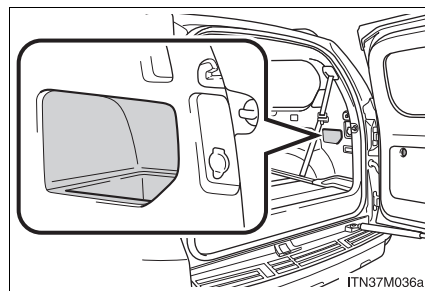

Remove the cover.

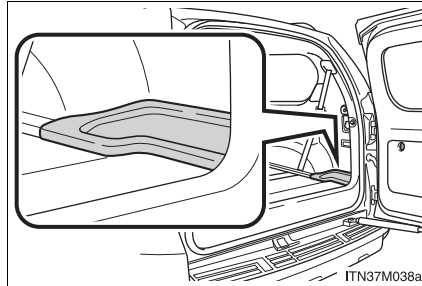
Auxiliary tray (if equipped)**Luggage cover (if equipped)**■ **Installing the luggage cover**

- 1 Attach the hooks to the head restraints.

Vehicles with the third seats: When using the luggage cover, the third seat must be fold down. (→P. 182, 184)

▶ 3-doors models

▶ 5-doors models

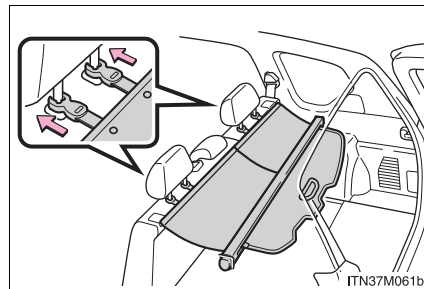
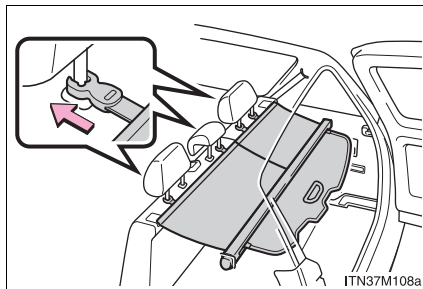

- 2 Pull out the luggage cover and hook it on the anchors.

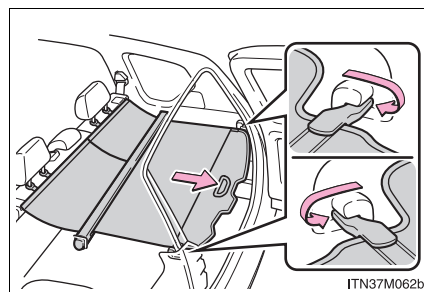

■ **Removing the luggage cover**

Retract the cover and release both ends, then lift it out.

After removing the luggage cover, place it somewhere other than the passenger compartment.

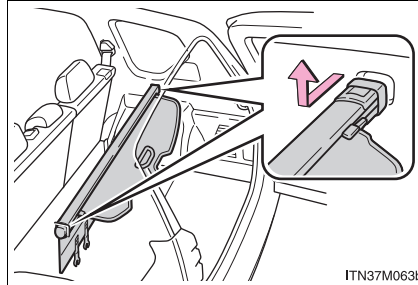

■ **Adjusting the sub cover (if equipped)**



Fasten the button when the second seats are in the rear-most position. Unfasten the buttons before sliding the second seats forward.

⚠ CAUTION

- To avoid injury, always return the cargo hooks to their stowed positions.
- Keep the auxiliary box closed. In the event of sudden braking or sudden swerving, an accident may occur due to an occupant being struck by an open auxiliary box or the items stored inside.
- Do not allow children to climb on the luggage cover. Climbing on the luggage cover could result in damage to the luggage cover, possibly causing death or serious injury to the child.

Other interior features

Cool box (if equipped)

- 1 Lift the lid while pulling up the knob to release the lock.

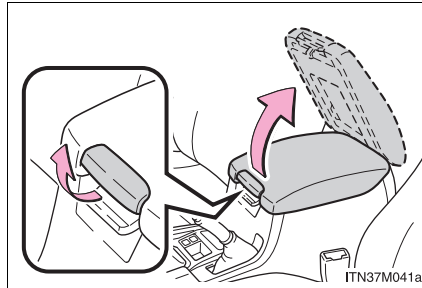

- 2 Turns the cool box on/off
When on, the indicator light comes on.

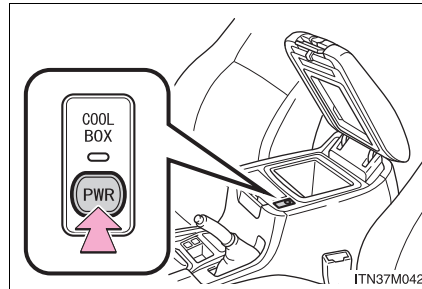

■ The cool box can be operated when

- ▶ Vehicles with a manual air conditioning system

Vehicles without a smart entry & start system:

The engine switch is in the "ON" position, and the front air conditioning system is turned on.

Vehicles with a smart entry & start system:

The engine switch is in IGNITION ON mode, and the front air conditioning system is turned on.

- ▶ Vehicles with an automatic air conditioning system

Vehicles without a smart entry & start system:

The engine switch is in the "ON" position.

Vehicles with a smart entry & start system:

The engine switch is in IGNITION ON mode.

■ If the front air conditioning system is not in use when the cool box is turned on (vehicles with an automatic air conditioning system)

The front air conditioning system is automatically turned on.

■ **Items unsuitable for the cool box**

- Drinks in unsealed containers
- Fragile items, perishables or anything with strong odor
- Owner's manual, electronic devices, CDs, etc.

■ **When the indicator light flashes**

The cool box is not operated when any of the following conditions occurs.

- When the air conditioning system is off
Turn the air conditioning system on also turns on the cool box.
- When outside air temperature is about 0°C (32°F) or below

If the indicator light continues to flash, there may be a malfunction in the system. Turn the air conditioning system off and have it inspected by any authorized Toyota dealer or repairer, or another duly qualified and equipped professional.

■ **When using the cool box lid as an armrest**

Slide the cool box lid forward or backward as needed. Slide the lid while pulling up the lever to release the lock.

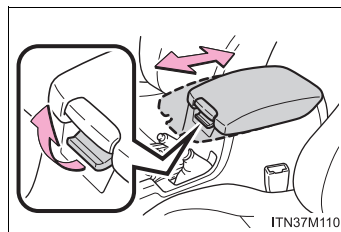

⚠ CAUTION

Keep the cool box closed. In the event of sudden braking or sudden swerving, an accident may occur due to an occupant being struck by the open cool box or the items stored inside.

⚠ NOTICE

To prevent battery discharge, do not leave the cool box on longer than necessary when the engine is stopped.

Sun visors

► Type A

- ① To set the visor in the forward position, flip it down.
- ② To set the visor in the side position, flip down, unhook, and swing it to the side.

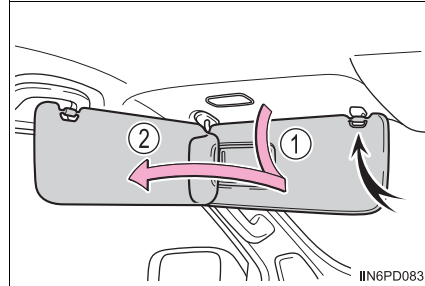

► Type B

- ① To set the visor in the forward position, flip it down.
- ② To set the visor in the side position, flip down, unhook, and swing it to the side.
- ③ To use the side extender, place the visor in the side position, then slide it backward.

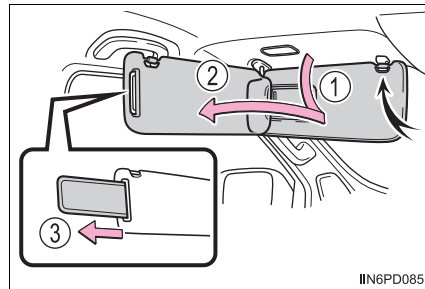

Vanity mirror

Slide the cover to open.

The light turns on when the cover is opened.

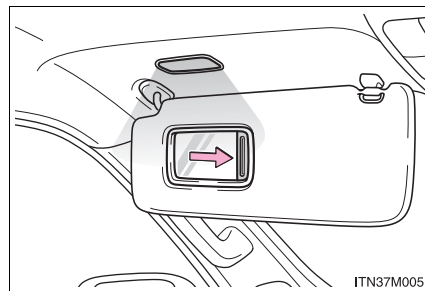

⚠ NOTICE

To prevent battery discharge, do not leave the vanity lights on for extended periods when the engine is not running.

Conversation mirror

The conversation mirror can provide the driver and the front passenger with a view of the rear seat area without the need to turn around.

Press in the button.

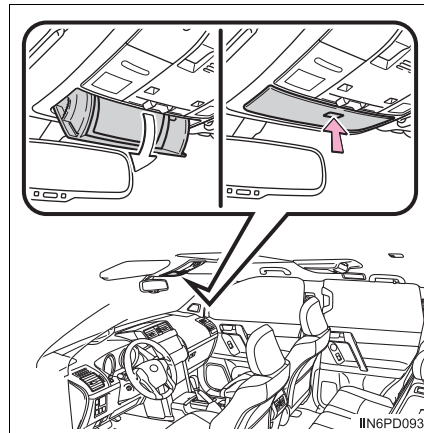

To use the overhead console when the conversation mirror is open, further extend down the lid. (→P. 488)

Clock

▶ Vehicles with a front manual air conditioning system

- ① Adjusts the hours
- ② Adjusts the minutes

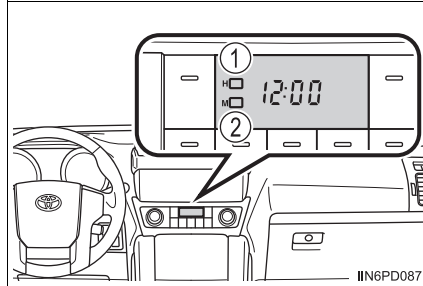

▶ Vehicles with a front automatic air conditioning system

- ① Adjusts the hours
- ② Adjusts the minutes
- ③ Rounds the nearest hour*

*: e.g. 1:00 to 1:29 → 1:00
1:30 to 1:59 → 2:00

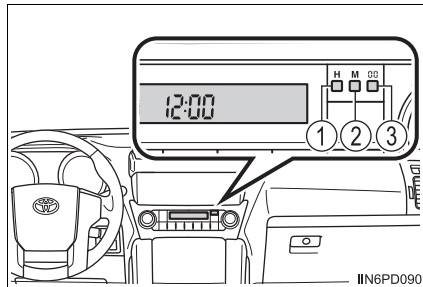

■ The clock is displayed when

▶ Vehicles without a smart entry & start system

The engine switch is in the “ACC” or “ON” position.

▶ Vehicles with a smart entry & start system

The engine switch is in ACCESSORY or IGNITION ON mode.

■ When disconnecting and reconnecting battery terminals

The clock data will be reset.

Power outlet

The power outlet can be used for the following components:

12 V DC:

Accessories that run on less than 10 A.

Accessories that run on less than 10 A should be used when using several power outlets at the same time.

220 V AC:

Accessories that use less than 100 W.

■ Center of console (12 V DC)

▶ Vehicles with an automatic transmission

▶ Vehicles with a manual transmission

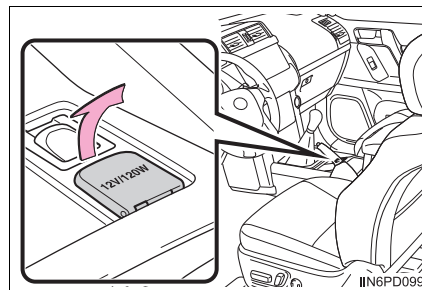
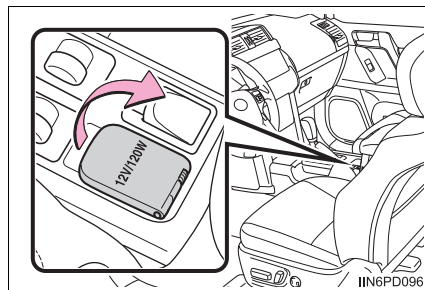

▶ Rear of console box

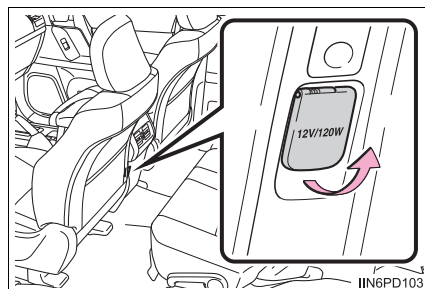

■ **Luggage compartment (12 V DC) (if equipped)**

▶ 3 door models

▶ 5 door models

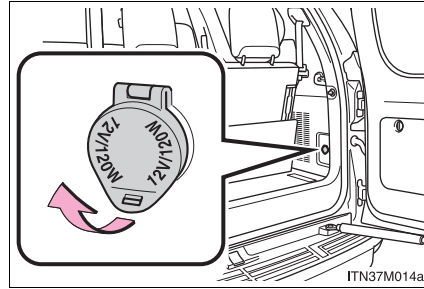
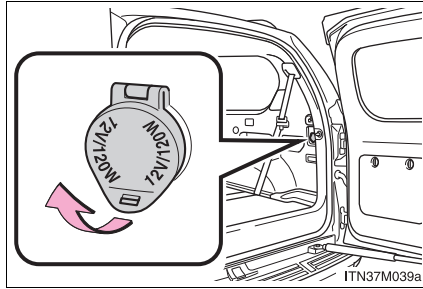

■ **Luggage compartment (220 V AC) (if equipped)**

▶ 3 door models

▶ 5 door models

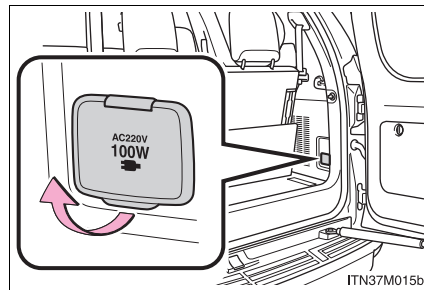
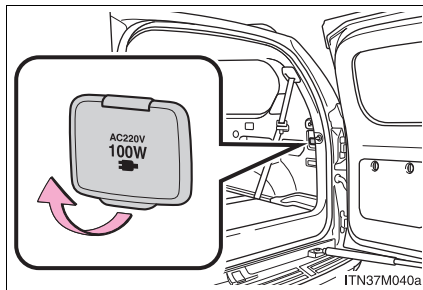

■ **The power outlet can be used when**

▶ Vehicles without a smart entry & start system

12 V DC: The engine switch is in the “ACC” or “ON” position.

220 V AC: The engine switch is in the “ON” position.

▶ Vehicles with a smart entry & start system

12 V DC: The engine switch is in ACCESSORY or IGNITION ON mode.

220 V AC: The engine switch is in IGNITION ON mode.

 NOTICE

■ **To avoid damaging the power outlet**

Close the power outlet lid when the power outlet is not in use.
Foreign objects or liquids that enter the power outlet may cause a short circuit.

■ **To prevent blown fuse**

▶ 12 V DC

Do not use an accessory that uses more than 12 V 10 A.

▶ 220 V AC

Do not use a 220 V AC appliance that requires more than 100 W.

If a 220 V AC appliance that consumes more than 100 W is used, the protection circuit will cut the power supply.

■ **To prevent battery discharge**

Do not use the power outlet longer than necessary when the engine is not running.

■ **Appliances that may not operate properly (220 V AC)**

The following 220 V AC appliances may not operate properly even if their power consumption is under 100 W:

- Appliances with high initial peak wattage
- Measuring devices that process precise data
- Other appliances that require an extremely stable power supply

Armrest (if equipped)

Fold down the armrest for use.

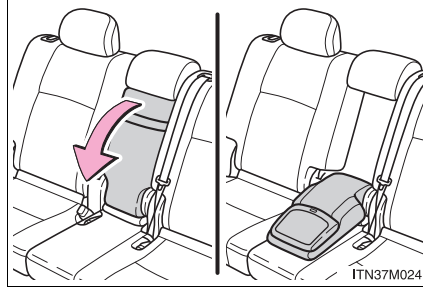
 **NOTICE**

To prevent damage, do not apply too heavy a load on the armrest.

Coat hooks

The coat hooks are provided with the rear assist grips.

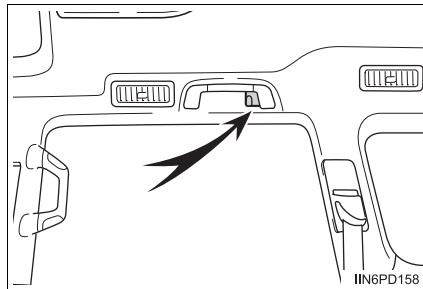
 **CAUTION**

Vehicles with SRS curtain shield airbags: Do not hang coat hangers or other hard or sharp objects on the hook. If the SRS curtain shield airbags deploy, these items may become projectiles, causing death or serious injury.

Assist grips

An assist grip (Type A) can be used to support your body while sitting on the seat.

An assist grip (Type B) can be used when getting in or out of the vehicle and others.

- ① Assist grip (Type A)
- ② Assist grip (Type B)

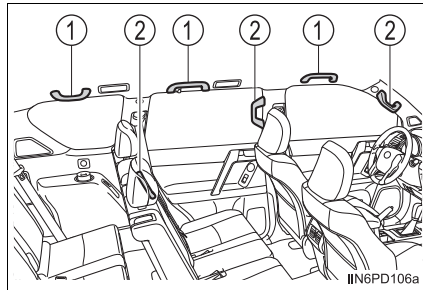

⚠ CAUTION

Do not use the assist grip (Type A) when getting in or out of the vehicle or rising from your seat.

⚠ NOTICE

To prevent damage, do not hang heavy objects or put a heavy load on the assist grip.

Ashtray (if equipped)

The ashtray can be installed in the auxiliary box (type E and F: →P. 488) or cup holder (→P. 485).

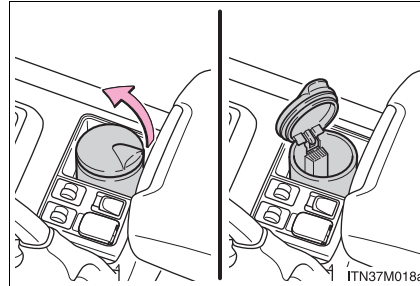
**⚠ CAUTION****■ When not in use**

Keep the ashtray closed. In the event of sudden braking or sudden swerving, an accident may occur due to an occupant being struck by the open ashtray or ash flying out.

■ To prevent fire

- Fully extinguish matches and cigarettes before putting them in the ashtray, then make sure the ashtray is fully closed.
- Do not place paper or any other type of flammable object in the ashtray.

Maintenance and care**7****7-1. Maintenance and care**

- Cleaning and protecting the vehicle exterior506
- Cleaning and protecting the vehicle interior510

7-2. Maintenance

- Maintenance requirements.....513

7-3. Do-it-yourself maintenance

- Do-it-yourself service precautions516
- Hood519
- Engine compartment.....520
- Tires.....539
- Tire inflation pressure552
- Wheels.....554
- Air conditioning filter557
- Wireless remote control/electronic key battery559
- Checking and replacing fuses563
- Light bulbs567

Cleaning and protecting the vehicle exterior

Perform the following to protect the vehicle and maintain it in prime condition:

- Working from top to bottom, liberally apply water to the vehicle body, wheel wells and underside of the vehicle to remove any dirt and dust.
- Wash the vehicle body using a sponge or soft cloth, such as a chamois.
- For hard-to-remove marks, use car wash soap and rinse thoroughly with water.
- Wipe away any water.
- Wax the vehicle when the waterproof coating deteriorates.

If water does not bead on a clean surface, apply wax when the vehicle body is cool.

■ Automatic car washes

- Fold the mirrors back before washing the vehicle. Start washing from the front of the vehicle. Make sure to extend the mirrors before driving.
- Brushes used in automatic car washes may scratch the vehicle surface and harm your vehicle's paint.

■ High pressure car washes

- Do not allow the nozzles of the car wash to come within close proximity of the windows and the air suspension unit.
- Before using the car wash, check that the fuel filler door on your vehicle is closed properly.

■ Aluminum wheels

- Remove any dirt immediately by using a neutral detergent. Do not use hard brushes or abrasive cleaners. Do not use strong or harsh chemical cleaners. Use the same mild detergent and wax as used on the paint.
- Do not use detergent on the wheels when they are hot, for example after driving for long distance in the hot weather.
- Wash detergent from the wheels immediately after use.

■ Bumpers

Do not scrub with abrasive cleaners.

■ Notes for a smart entry & start system (if equipped)

- If the door handle becomes wet while the electronic key is within the effective range, the door may lock and unlock repeatedly. Place the key in a position 2 m (6 ft.) or more separate from the vehicle while the vehicle is being washed. (Take care to ensure that the key is not stolen.)
- If the electronic key is inside the vehicle and a door handle becomes wet during a car wash, a message may be shown on the multi-information display and a buzzer will sound outside the vehicle. To turn off the alarm, lock all the doors.

CAUTION

■ **When washing the vehicle**

Do not apply water to the inside of the engine compartment. Doing so may cause the electrical components etc. to catch fire.

■ **When cleaning the windshield (vehicles with rain-sensing windshield wiper)**

Set the wiper switch to off.
If the wiper switch is in "AUTO", the wipers may operate unexpectedly in the following situations, and may result in hands being caught or other serious injuries and cause damage to the wiper blades.

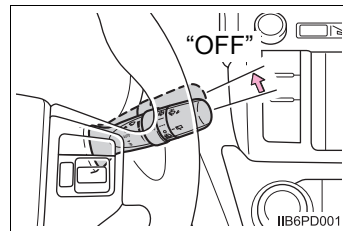

- When the upper part of the windshield where the raindrop sensor is located is touched by hand
- When a wet rag or similar is held close to the raindrop sensor
- If something bumps against the windshield
- If you directly touch the raindrop sensor body or if something bumps into the raindrop sensor

■ **Precautions regarding the exhaust pipe**

Exhaust gasses cause the exhaust pipe to become quite hot.

When washing the vehicle, be careful not to touch the pipe until it has cooled sufficiently, as touching a hot exhaust pipe can cause burns.

■ **Precautions regarding the Blind Spot Monitor (if equipped)**

If the paint of the rear bumper is chipped or scratched, the system may malfunction.

If this occurs, consult any authorized Toyota dealer or repairer, or another duly qualified and equipped professional.



NOTICE

■ To prevent paint deterioration and corrosion on the body and components (aluminum wheels etc.)

- Wash the vehicle immediately in the following cases:
 - After driving near the sea coast
 - After driving on salted roads
 - If coal tar or tree sap is present on the paint surface
 - If you see dead insects, insect droppings or bird droppings on the paint
 - After driving in an area contaminated with soot, oily smoke, mine dust, iron powder or chemical substances
 - If the vehicle becomes heavily soiled in dust or mud
 - If liquids such as benzene and gasoline are spilled on the paint surface
- If the paint is chipped or scratched, have it repaired immediately.
- To prevent the wheels from corroding, remove any dirt and store in a place with low humidity when storing wheels.

■ Cleaning the exterior lights

- Wash carefully. Do not use organic substances or scrub with a hard brush. This may damage the surfaces of the lights.
- Do not apply wax on the surfaces of the lights. Wax may cause damage to the lenses.

■ To prevent damage to the windshield wiper arms

When lifting the wiper arms away from the windshield, pull the driver side wiper arm upward first, and repeat for the passenger side. When returning the wipers to their original position, do so from the passenger side first.

■ When using an automatic car wash (vehicles with rain sensing windshield wipers)

Set the wiper switch to the off position.

If the wiper switch is in "AUTO", the wipers may operate and the wiper blades may be damaged.

Cleaning and protecting the vehicle interior

The following procedures will help protect your vehicle's interior and keep it in top condition:

Protecting the vehicle interior

Remove dirt and dust using a vacuum cleaner. Wipe dirty surfaces with a cloth dampened with lukewarm water.

Cleaning the leather areas

- Remove dirt and dust using a vacuum cleaner.
- Wipe any excess dirt and dust with a soft cloth dampened with diluted detergent.

Use a diluted water solution of approximately 5 % neutral wool detergent.

- Wring out any excess water from the cloth and thoroughly wipe off all remaining traces of detergent.
- Wipe the surface with a dry, soft cloth to remove any remaining moisture. Allow the leather to dry in a shaded ventilated area.

Cleaning the synthetic leather areas

- Remove loose dirt using a vacuum cleaner.
- Apply a mild soap solution to the synthetic leather using a sponge or soft cloth.
- Allow the solution to soak in for a few minutes. Remove the dirt and wipe off the solution with a clean, damp cloth.

■ Caring for leather areas

Toyota recommends cleaning the interior of the vehicle at least twice a year to maintain the quality of the vehicle's interior.

■ Shampooing the carpets

There are several commercial foaming-type cleaners available. Use a sponge or brush to apply the foam. Rub in overlapping circles. Do not use water. The excellent results are obtained when keeping the carpet as dry as possible.

■ Seat belts

Clean with mild soap and lukewarm water using a cloth or sponge. Also check the belts periodically for excessive wear, fraying or cuts.

⚠ CAUTION**■ Water in the vehicle**

- Do not splash or spill liquid in the vehicle.
Doing so may cause electrical components etc. to malfunction or catch fire.
- Do not get any of the SRS components or wiring in the vehicle interior wet.
(→P. 44)
An electrical malfunction may cause the airbags to deploy or not function properly, resulting in death or serious injury.

■ Cleaning the interior (especially instrument panel)

Do not use polish wax or polish cleaner. The instrument panel may reflect off the windshield, obstructing the driver's view and leading to an accident, resulting in death or serious injury.



NOTICE

■ Cleaning detergents

- Do not use the following types of detergent, as they may discolor the vehicle interior or cause streaks or damage to painted surfaces:
 - Non-seat portions: Organic substances such as benzene or gasoline, alkaline or acidic solutions, dye, and bleach
 - Seats: Alkaline or acidic solutions, such as thinner, benzene, and alcohol
- Do not use polish wax or polish cleaner. The instrument panel's or other interior part's painted surface may be damaged.

■ Preventing damage to leather surfaces

Observe the following precautions to avoid damage to and deterioration of leather surfaces:

- Remove any dust or dirt from leather surfaces immediately.
- Do not expose the vehicle to direct sunlight for extended periods of time. Park the vehicle in the shade, especially during summer.
- Do not place items made of vinyl, plastic, or containing wax on the upholstery, as they may stick to the leather surface if the vehicle interior heats up significantly.

■ Water on the floor

Do not wash the vehicle floor with water.

Vehicle systems such as the audio system may be damaged if water comes into contact with electrical components such as the audio system above or under the floor of the vehicle. Water may also cause the body to rust.

■ Cleaning the inside of the rear window

- Do not use glass cleaner to clean the rear window, as this may cause damage to the rear window defogger heater wires or antenna. Use a cloth dampened with lukewarm water to gently wipe the window clean. Wipe the window in strokes running parallel to the heater wires or antenna.
- Be careful not to scratch or damage the heater wires or antenna.

Maintenance requirements

To ensure safe and economical driving, day-to-day care and regular maintenance are essential. Toyota recommends the following maintenance:

Scheduled maintenance

Scheduled maintenance should be performed at specified intervals according to the maintenance schedule.

For full details of your maintenance schedule, refer to the “Toyota Service Booklet” or “Toyota Warranty Booklet”.

Do-it-yourself maintenance

What about do-it-yourself maintenance?

Many maintenance items are easy to do yourself if you have a little mechanical ability and a few basic automotive tools.

Note, however, that some maintenance tasks require special tools and skills. These are best performed by qualified technicians. Even if you're an experienced do-it-yourself mechanic, we recommend that repairs and maintenance be conducted by any authorized Toyota dealer or repairer, or another duly qualified and equipped professional. Any authorized Toyota dealer or repairer will keep a record of maintenance, which could be useful should you ever require Warranty Service. Should you choose to select a qualified and equipped professional other than an authorized Toyota repairer to service or maintain your vehicle, we recommend that you request that a record of maintenance be kept.

■ Where to go for maintenance service?

In order to maintain your vehicle in the best possible condition, Toyota recommends that maintenance service operations as well as other inspections and repairs be carried out by authorized Toyota dealers or repairers or other duly qualified and equipped professionals. For repairs and services covered by your warranty, please visit an authorized Toyota dealer or repairer, who will use genuine Toyota parts in repairing any difficulties you may encounter. There can also be advantages in utilizing authorized Toyota dealers or repairers for non-warranty repairs and services, as members of the Toyota network will be able to expertly assist you with any difficulties you may encounter.

Your Toyota dealer or repairer, or another duly qualified and equipped professional will perform all of the scheduled maintenance on your vehicle reliably and economically due to their experience with Toyota vehicles.

■ Does your vehicle need repairs?

Be on the alert for changes in performance and sounds, and visual tip-offs that indicate service is needed. Some important clues are:

- Engine missing, stumbling or pinging
- Appreciable loss of power
- Strange engine noises
- A fluid leak under the vehicle (However, water dripping from the air conditioning system after use is normal.)
- Change in exhaust sound (This may indicate a dangerous carbon monoxide leak. Drive with the windows open and have the exhaust system checked immediately.)
- Flat-looking tires, excessive tire squeal when cornering, uneven tire wear
- Vehicle pulls to one side when driven straight on a level road
- Strange noises related to suspension movement
- Loss of brake effectiveness, spongy feeling brake pedal or clutch pedal, pedal almost touches the floor, vehicle pulls to one side when braking
- Engine coolant temperature continually higher than normal (→P. 107)

If you notice any of these clues, take your vehicle to any authorized Toyota dealer or repairer, or another duly qualified and equipped professional as soon as possible. Your vehicle may need adjustment or repair.

 CAUTION**■ If your vehicle is not properly maintained**

Improper maintenance could result in serious damage to the vehicle and possible serious injury or death.

■ Handling of the battery

Battery posts, terminals and related accessories contain lead and lead compounds which are known to cause brain damage. Wash your hands after handling. (→P. 531)

Do-it-yourself service precautions

If you perform maintenance yourself, be sure to follow the correct procedures as given in these sections.

Items	Parts and tools
Battery condition (→P. 532)	<ul style="list-style-type: none"> • Warm water • Baking soda • Grease • Conventional wrench (for terminal clamp bolts) • Distilled water
Engine coolant level (→P. 529)	<ul style="list-style-type: none"> • “Toyota Super Long Life Coolant” or similar high quality ethylene glycol based non-silicate, non-amine, non-nitrite and non-borate coolant with long-life hybrid organic acid technology. “Toyota Super Long Life Coolant” is pre-mixed with 50% coolant and 50% deionized water. • Funnel (used only for adding coolant)
Engine oil level (→P. 525)	<ul style="list-style-type: none"> • “Toyota Genuine Motor Oil” or equivalent • Rag or paper towel • Funnel (used only for adding engine oil)
Fuses (→P. 564)	<ul style="list-style-type: none"> • Fuse with same amperage rating as original
Light bulbs (→P. 568)	<ul style="list-style-type: none"> • Bulb with same number and wattage rating as original • Phillips-head screwdriver • Flathead screwdriver • Wrench
Radiator, condenser and intercooler (→P. 531)	—
Tire inflation pressure (→P. 553)	<ul style="list-style-type: none"> • Tire pressure gauge • Compressed air source
Washer fluid (→P. 536)	<ul style="list-style-type: none"> • Water or washer fluid containing antifreeze (for winter use) • Funnel (used only for adding water or washer fluid)

 **CAUTION**

The engine compartment contains many mechanisms and fluids that may move suddenly, become hot, or become electrically energized. To avoid death or serious injury, observe the following precautions:

■ **When working on the engine compartment**

- Keep hands, clothing and tools away from the moving fan and engine drive belt.
- Be careful not to touch the engine, radiator, exhaust manifold, etc. right after driving as they may be hot. Oil and other fluids may also be hot.
- Do not leave anything that may burn easily, such as paper or rags, in the engine compartment.
- Do not smoke, cause sparks or expose an open flame to fuel or the battery. Fuel and battery fumes are flammable.
- Be extremely cautious when working on the battery. It contains poisonous and corrosive sulfuric acid.
- Take care because brake fluid can harm your hands or eyes and damage painted surfaces. If fluid gets on your hands or in your eyes, flush the affected area with clean water immediately. If you still experience discomfort, consult a doctor.

■ **When working near the electric cooling fans or radiator grille**

Vehicles without a smart entry & start system: Be sure the engine switch is off. With the engine switch in the "ON" position, the electric cooling fans may automatically start to run if the air conditioning is on and/or the coolant temperature is high. (→P. 531)

Vehicles with a smart entry & start system: Be sure the engine switch is off. With the engine switch in IGNITION ON mode, the electric cooling fans may automatically start to run if the air conditioning is on and/or the coolant temperature is high. (→P. 531)

■ **When working on or under the vehicle**

Do not get under the vehicle with just the jack supporting it. Always use automotive jack stands or other solid supports.

■ **Safety glasses**

Wear safety glasses to prevent flying or falling material, fluid spray, etc. from getting in your eyes.



NOTICE

■ **If you remove the air cleaner filter**

Driving with the air cleaner filter removed may cause excessive engine wear due to dirt in the air.

■ **If the fluid level is low or high**

It is normal for the brake fluid level to go down slightly as the brake pads wear or when the fluid level in the accumulator is high.
If the reservoir needs frequent refilling, it may indicate a serious problem.

Hood

Release the lock from the inside of the vehicle to open the hood.

- 1 Pull the hood lock release lever.
The hood will pop up slightly.

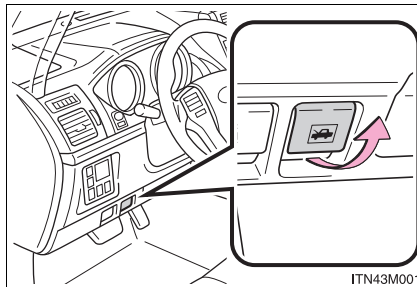

- 2 Move the auxiliary catch lever to side direction and lift the hood.

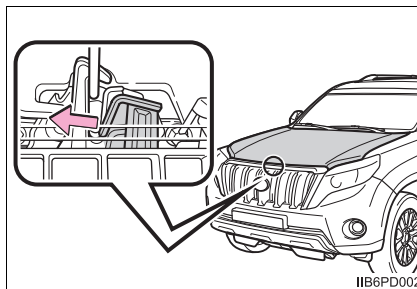

⚠ CAUTION

■ Pre-driving check

Check that the hood is fully closed and locked.
If the hood is not locked properly, it may open while the vehicle is in motion and cause an accident, which may result in death or serious injury.

Engine compartment

► 2TR-FE engine

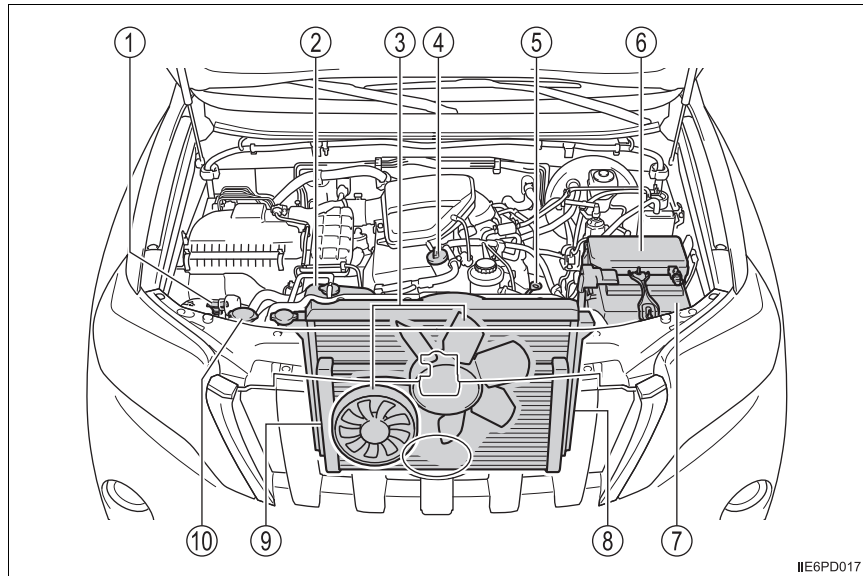

- | | |
|---|--|
| ① Discharging dust valve
(→P. 538) | ⑤ Engine oil level dipstick
(→P. 525) |
| ② Engine coolant reservoir
(→P. 529) | ⑥ Fuse box
(→P. 564) |
| ③ Cooling fans | ⑦ Battery
(→P. 532) |
| ④ Engine oil filler cap (→P. 527) | ⑧ Radiator
(→P. 531) |
| | ⑨ Condenser
(→P. 531) |
| | ⑩ Washer fluid tank (→P. 536) |

► 1GR-FE engine

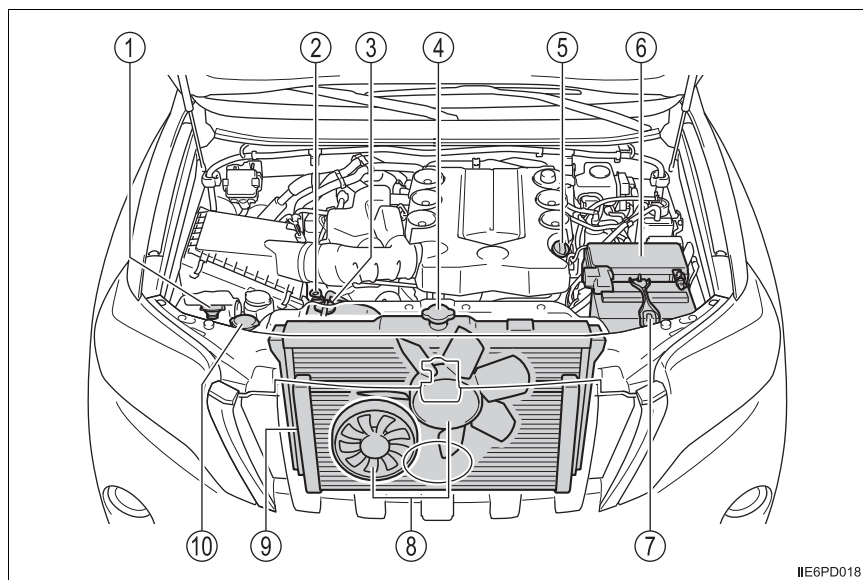

- | | |
|---|-----------------------------------|
| ① Discharging dust valve
(if equipped) (→P. 538) | ⑤ Engine oil filler cap (→P. 527) |
| ② Engine oil level dipstick
(→P. 525) | ⑥ Fuse box (→P. 564) |
| ③ Engine coolant reservoir
(→P. 529) | ⑦ Battery (→P. 532) |
| ④ Radiator (→P. 531) | ⑧ Cooling fans |
| | ⑨ Condenser (→P. 531) |
| | ⑩ Washer fluid tank (→P. 536) |

► 1KD-FTV engine

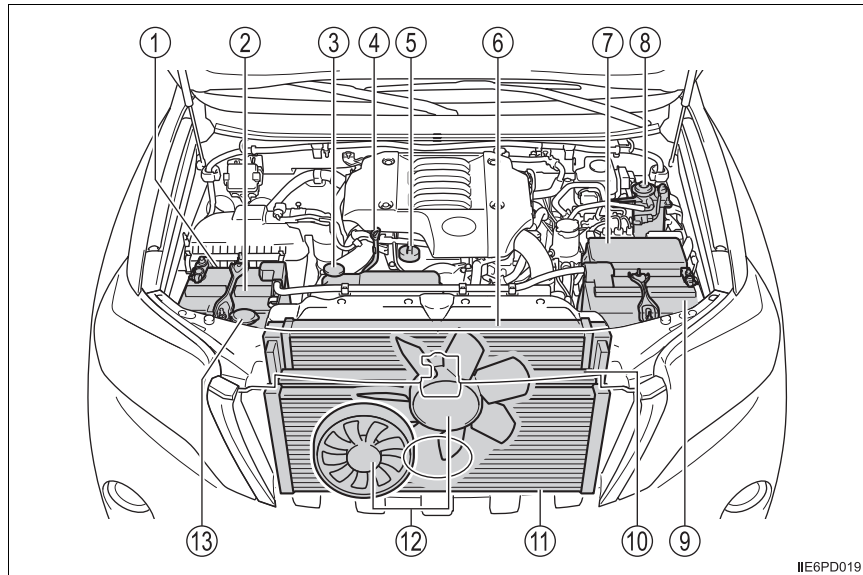

- | | |
|--|---------------------------------|
| ① Discharging dust valve
(→P. 538) | ⑥ Radiator
(→P. 531) |
| ② Battery
(if equipped) (→P. 529) | ⑦ Fuse box
(→P. 564) |
| ③ Engine coolant reservoir
(→P. 529) | ⑧ Fuel filter
(→P. 539, 672) |
| ④ Engine oil level dipstick
(→P. 525) | ⑨ Battery
(→P. 529) |
| ⑤ Engine oil filler cap (→P. 527) | ⑩ Intercooler
(→P. 531) |
| | ⑪ Condenser
(→P. 531) |
| | ⑫ Cooling fans |
| | ⑬ Washer fluid tank (→P. 536) |

Engine compartment cover

■ Removing the engine compartment cover

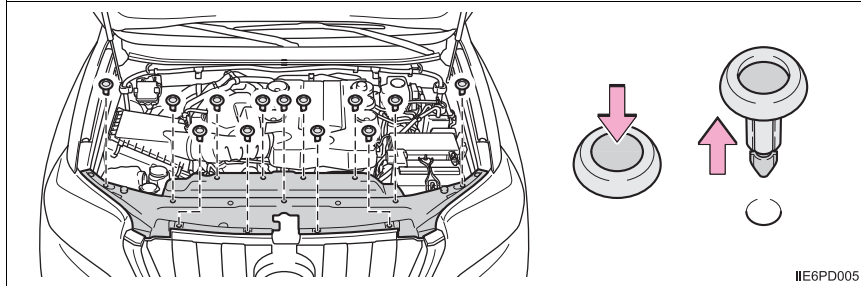

■ Installing the clips

- ① Push up center portion
- ② Insert
- ③ Press

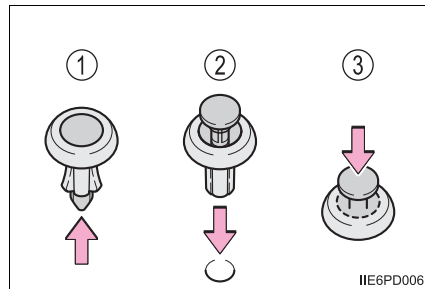

⚠ NOTICE

■ After installing an engine compartment cover

Make sure the cover is securely installed in its original position.

Engine oil

With the engine at operating temperature and turned off, check the oil level on the dipstick.

■ Checking the engine oil

- 1 Park the vehicle on level ground. After warming up the engine and turning it off, wait more than five minutes for the oil to drain back into the bottom of the engine.
- 2 Holding a rag under the end, pull the dipstick out.

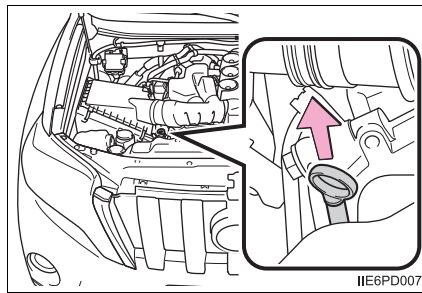

- 3 Wipe the dipstick clean.
- 4 Reinsert the dipstick fully.

- 5 Holding a rag under the end, pull the dipstick out and check the oil level.
- ① Low
 - ② Normal
 - ③ Excessive

► Type A

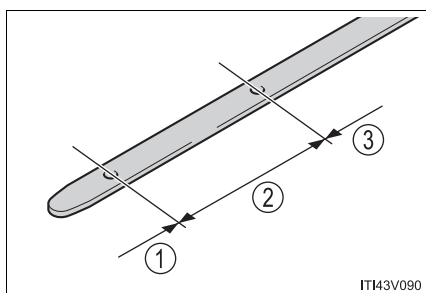

► Type B

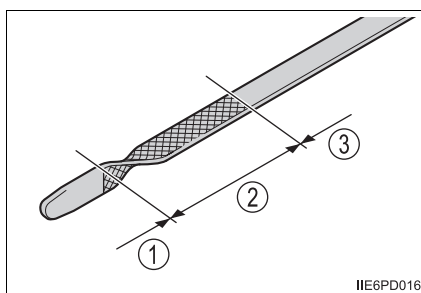

The shape of the dipstick may differ depending on the type of vehicle or engine.

- 6 Wipe the dipstick and reinsert it fully.

■ **Adding engine oil**

If the oil level is below or near the low level mark, add engine oil of the same type as already in the engine.

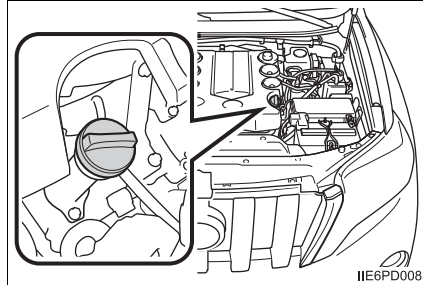

Make sure to check the oil type and prepare the items needed before adding oil.

Engine oil selection		→P. 683
Oil quantity (Low → Full)	1GR-FE engine	1.7 L (1.8 qt., 1.5 Imp.qt.)
	1KD-FTV and 2TR-FE engines	1.3 L (1.4 qt., 1.1 Imp.qt.)
Items		Clean funnel

- 1 Remove the oil filler cap by turning it counterclockwise.
- 2 Add engine oil slowly, checking the dipstick.
- 3 Install the oil filler cap by turning it clockwise.

■ Engine oil consumption

A certain amount of engine oil will be consumed while driving. In the following situations, oil consumption may increase, and engine oil may need to be refilled in between oil maintenance intervals.

- When the engine is new, for example directly after purchasing the vehicle or after replacing the engine
- If low quality oil or oil of an inappropriate viscosity is used
- When driving at high engine speeds or with a heavy load, when towing, or when driving while accelerating or decelerating frequently
- When leaving the engine idling for a long time, or when driving frequently through heavy traffic

■ After changing the engine oil (diesel engine only*1)

The oil maintenance data should be reset. Perform the following procedures:

- 1 Switch the display to the trip meter "A" when the engine is running. (→P. 111)
- 2 Turn the engine switch off.
- 3 While pressing the "ODO TRIP" button (→P. 111), set the engine switch to IGNITION ON mode (but do not start the engine because otherwise the reset mode will be canceled). Continue to press and hold the button until the multi-information display indicates that the reset is complete.

*1: Except for KDJ150L-GKFEY, KDJ150L-GKAEY models*2

*2: The model code is indicated on the manufacturer's label. (→P. 679)

⚠ CAUTION

■ Used engine oil

- Used engine oil contains potentially harmful contaminants which may cause skin disorders such as inflammation or skin cancer, so care should be taken to avoid prolonged and repeated contact. To remove used engine oil from your skin, wash thoroughly with soap and water.
- Dispose of used oil and filters only in a safe and acceptable manner. Do not dispose of used oil and filters in household trash, in sewers or onto the ground. Call any authorized Toyota dealer or repairer, or another duly qualified and equipped professional, service station or auto parts store for information concerning recycling or disposal.
- Do not leave used engine oil within the reach of children.

 NOTICE

■ **To prevent serious engine damage**

Check the oil level on regular basis.

■ **When replacing the engine oil**

- Be careful not to spill engine oil on the vehicle components.
- Avoid overfilling, or the engine could be damaged.
- Check the oil level on the dipstick every time you refill the vehicle.
- Be sure the engine oil filler cap is properly tightened.

Engine coolant

► Gasoline engine

The coolant level is satisfactory if it is between the “F” and “L” lines on the reservoir when the engine is cold.

- ① Reservoir cap
- ② “F” line
- ③ “L” line

If the level is on or below the “L” line, add coolant up to the “F” line.

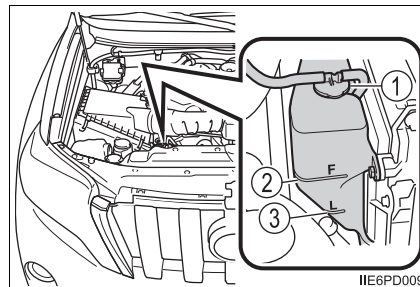

► Diesel engine

The coolant level is satisfactory if it is between the “FULL” and “LOW” lines on the reservoir when the engine is cold.

- ① Reservoir cap
- ② “FULL” line
- ③ “LOW” line

If the level is on or below the “LOW” line, add coolant up to the “FULL” line.

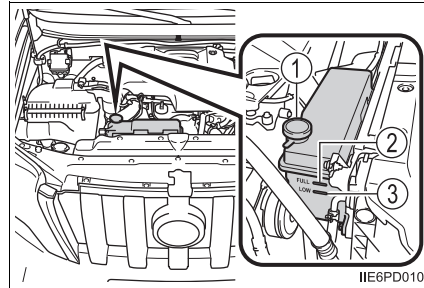

■ **Coolant selection**

Only use “Toyota Super Long Life Coolant” or a similar high quality ethylene glycol based non-silicate, non-amine, non-nitrite, and non-borate coolant with long-life hybrid organic acid technology.

“Toyota Super Long Life Coolant” is a mixture of 50% coolant and 50% deionized water. (Enabled: -35°C [-31°F])

For more details about engine coolant, contact any authorized Toyota dealer or repairer, or another duly qualified and equipped professional.

■ **If the coolant level drops within a short time of replenishing**

Visually check the radiator, hoses, engine coolant reservoir caps, drain cock and water pump. If you cannot find a leak, have any authorized Toyota dealer or repairer, or another duly qualified and equipped professional test the cap and check for leaks in the cooling system.

 CAUTION

■ **When the engine is hot**

Do not remove the radiator cap, or the coolant reservoir cap. The cooling system may be under pressure and may spray hot coolant if the cap is removed, causing serious injuries, such as burns.

 NOTICE

■ **When adding coolant**

Coolant is neither plain water nor straight antifreeze. The correct mixture of water and antifreeze must be used to provide proper lubrication, corrosion protection and cooling. Be sure to read the antifreeze or coolant label.

■ **If you spill coolant**

Be sure to wash it off with water to prevent it from damage to parts or paint.

Radiator, condenser and intercooler

Check the radiator, condenser and intercooler (if equipped) and clear any foreign objects. If any of the above parts are extremely dirty or you are not sure of their condition, have your vehicle inspected by any authorized Toyota dealer or repairer, or another duly qualified and equipped professional.

 CAUTION

■ **When the engine is hot**





Do not touch the radiator, condenser or intercooler as they may be hot and cause serious injuries, such as burns.

Battery

Check the battery as follows.

■ Caution symbols

The meanings of each caution symbol on the top of the battery are as follows:

	No smoking, no naked flames, no sparks		Battery acid
	Shield eyes		Note operating instructions
	Keep away from children		Explosive gas

■ Battery exterior

Make sure that the battery terminals are not corroded and that there are no loose connections, cracks, or loose clamps.

- ① Terminals
- ② Hold-down clamp

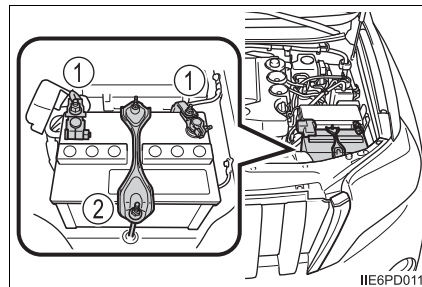

■ **Checking battery fluid**

Check that the level is between the “UPPER LEVEL” and “LOWER LEVEL” lines.

- ① “UPPER LEVEL” line
- ② “LOWER LEVEL” line

If the fluid level is at or below the “LOWER LEVEL” line, add distilled water.

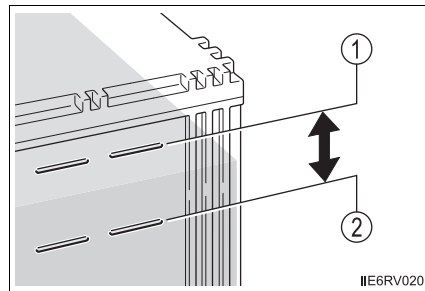

■ **Adding distilled water**

- 1 Remove the vent plug.
- 2 Add distilled water.

If the “UPPER LEVEL” line cannot be seen, check the fluid level by looking directly at the cell.

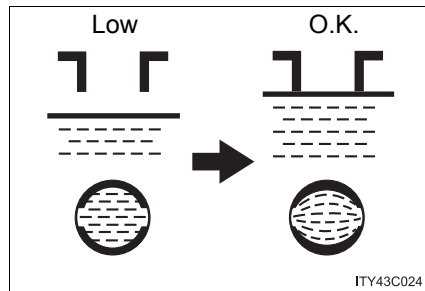

- 3 Put the vent plug back on and close securely.

■ Before recharging

When recharging, the battery produces hydrogen gas which is flammable and explosive. Therefore, observe the following before recharging:

- If recharging with the battery installed on the vehicle, be sure to disconnect the ground cable.
- Make sure the power switch on the charger is off when connecting and disconnecting the charger cables to the battery.

■ After recharging/reconnecting the battery (vehicles with a smart entry & start system)

The engine may not start. Follow the procedure below to initialize the system.

- 1 Shift the shift lever to P (automatic transmission) or depress the brake pedal with the shift lever in N (manual transmission).
- 2 Open and close any of the doors.
- 3 Restart the engine.
 - Unlocking the doors using the smart entry & start system may not be possible immediately after reconnecting the battery. If this happens, use the wireless remote control or the mechanical key to lock/unlock the doors.
 - Start the engine with the engine switch in ACCESSORY mode. The engine may not start with the engine switch turned off. However, the engine will operate normally from the second attempt.
 - The engine switch mode is recorded by the vehicle. If the battery is reconnected, the vehicle will return the engine switch mode to the status it was in before the battery was disconnected. Make sure to turn off the engine before disconnect the battery. Take extra care when connecting the battery if the engine switch mode prior to discharge is unknown.

If the system will not start even after multiple attempts, contact any authorized Toyota dealer or repairer, or another duly qualified and equipped professional.

 CAUTION**■ Chemicals in the battery**

Batteries contain poisonous and corrosive sulfuric acid and may produce hydrogen gas which is flammable and explosive. To reduce the risk of death or serious injury, take the following precautions while working on or near battery:

- Do not cause sparks by touching the battery terminals with tools.
- Do not smoke or light a match near the battery.
- Avoid contact with eyes, skin and clothes.
- Never inhale or swallow electrolyte.
- Wear protective safety glasses when working near the battery.
- Keep children away from the battery.

■ Where to safely charge the battery

Always charge the battery in an open area. Do not charge the battery in a garage or closed room where there is not sufficient ventilation.

■ Emergency measures regarding electrolyte

- If electrolyte gets in your eyes
Flush your eyes with clean water for at least 15 minutes and get immediate medical attention. If possible, continue to apply water with a sponge or cloth while traveling to the nearest medical facility.
- If electrolyte gets on your skin
Wash the affected area thoroughly. If you feel pain or burning, get medical attention immediately.
- If electrolyte gets on your clothes
It can soak through clothing on to your skin. Immediately take off the clothing and follow the procedure above if necessary.
- If you accidentally swallow electrolyte
Drink a large quantity of water or milk. Get emergency medical attention immediately.

 NOTICE

■ **When recharging the battery**

Never recharge the battery while the engine is running. Also, be sure all accessories are turned off.

■ **When adding distilled water**

Avoid overfilling. Water spilled during battery recharging may cause corrosion.

Washer fluid

Add washer fluid in any of the following situations:

- A washer does not work.
- The low washer fluid warning light comes on (→P. 598)
- The warning message appears on the multi-information display (vehicles with multi-information display type B only: →P. 611)
- The washer fluid level is at “LOW”

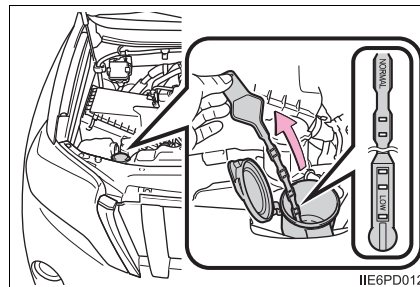
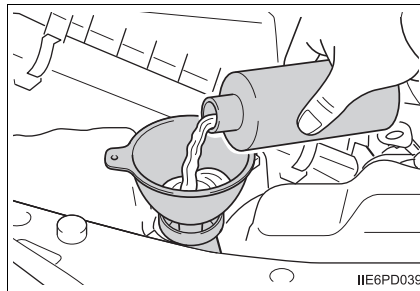

■ **Using the gauge (if equipped)**

The washer fluid level is checked by observing the position of the level on the liquid covered holes in the gauge.

If the level falls below the second hole from the bottom (“LOW” position), refill the washer fluid.

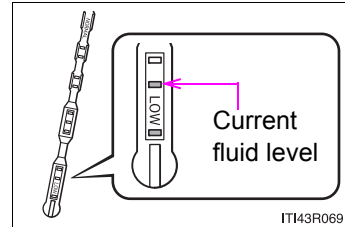

⚠ CAUTION

■ **When adding washer fluid**

Do not add washer fluid when the engine is hot or running as washer fluid contains alcohol and may catch fire if spilled on the engine etc.

⚠ NOTICE

■ **Do not use any fluid other than washer fluid**

Do not use soapy water or engine antifreeze instead of washer fluid. Doing so may cause streaking on the vehicle’s painted surfaces.

■ **Diluting washer fluid**

Dilute washer fluid with water as necessary. Refer to the freezing temperatures listed on the label of the washer fluid bottle.

Discharging dust valve (if equipped)

Squeeze the rubber cap to remove the dust if the discharging dust valve is dirty.

Shape of the valve differs slightly in accordance with the engine.

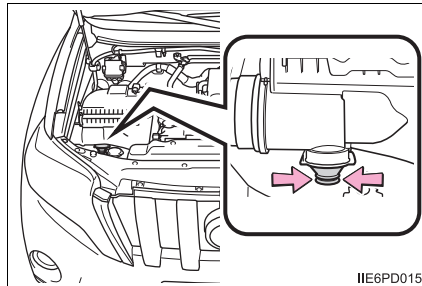
 NOTICE**■ To prevent damaging the engine**

Do not drive with the discharging dust valve removed. Doing so causes excessive engine wear.

Draining the fuel filter water (diesel engine only)

The water in the fuel filter must be drained immediately if the following symptom occurs:

- ▶ Vehicles with the multi-information display type A

The fuel system warning light flashes and buzzer sounds or the fuel filter warning light comes on.

- ▶ Vehicles with the multi-information display type B

When the warning message "DRAIN WATER FROM FUEL FILTER" appears on the instrument cluster and buzzer* sounds.

*: On some models

- 1 Remove the drain plug from the clamp and place a small tray to catch the water.

- 2 Perform the draining as shown in the illustration.

- 1 Turn the drain plug about 2-2-1/2 turns.

Loosening more than this will cause water oozing from around the drain plug.

- 2 Operate the priming pump until the fuel begins to run out.

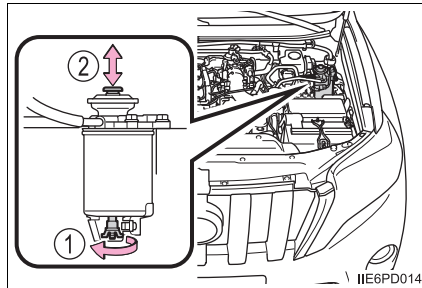

- 3 After draining, retighten the drain plug. Do not use a tool.

Tires

Replace or rotate the tires in accordance with maintenance schedules and treadwear.

Checking tires

- ① New tread
- ② Treadwear indicator
- ③ Worn tread

The location of treadwear indicators is shown by the “TWI” or “△” marks, etc., molded on the sidewall of each tire.

Check spare tire condition and pressure if not rotated.

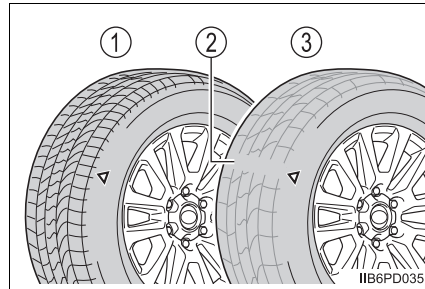

Tire rotation

Rotate the tires in the order shown.

To equalize tire wear and help extend tire life, Toyota recommends that you rotate your tires approximately every 5000 km (3000 miles).

Do not fail to initialize the tire pressure warning system after tire rotation.

- ▶ Vehicles with a standard spare tire
- ▶ Vehicles with an emergency tire puncture repair kit

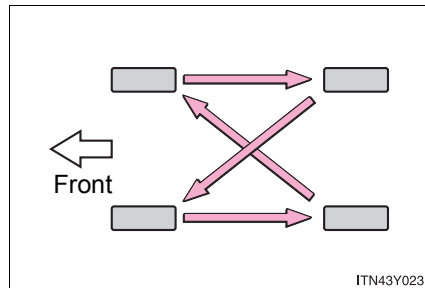
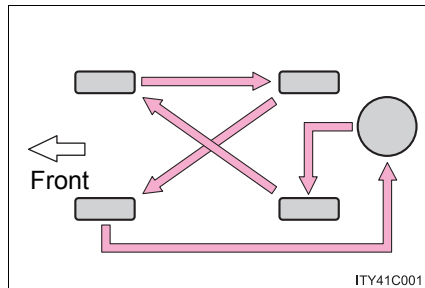

Tire pressure warning system (if equipped)

Your vehicle is equipped with a tire pressure warning system that uses tire pressure warning valves and transmitters to detect low tire inflation pressure before serious problems arise.

If the tire pressure drops below a predetermined level, the driver is warned by a warning light. (→P. 598)

◆ Installing tire pressure warning valves and transmitters

When replacing tires or wheels, tire pressure warning valves and transmitters must also be installed.

When new tire pressure warning valves and transmitters are installed, new ID codes must be registered in the tire pressure warning computer and the tire pressure warning system must be initialized. Have tire pressure warning valve and transmitter ID codes registered by any authorized Toyota dealer or repairer, or another duly qualified and equipped professional. (→P. 543)

◆ Initializing the tire pressure warning system

■ The tire pressure warning system must be initialized in the following circumstances:

- When changing the tire size.
- When the tire inflation pressure is changed such as when changing traveling speed.

When the tire pressure warning system is initialized, the current tire inflation pressure is set as the benchmark pressure.

■ How to initialize the tire pressure warning system

- 1 Park the vehicle in a safe place and turn the engine switch to the “LOCK” position (vehicles without a smart entry & start system) or off (vehicles with a smart entry & start system).

Initialization cannot be performed while the vehicle is moving.

- 2 Adjust the tire inflation pressure to the specified cold tire inflation pressure level. (→P. 699)

Make sure to adjust the tire pressure to the specified cold tire inflation pressure level. The tire pressure warning system will operate based on this pressure level.

- 3 Turn the engine switch to the “ON” position (vehicles without a smart entry & start system) or IGNITION ON mode (vehicles with a smart entry & start system).

- 4 Press and hold the tire pressure warning reset switch until the tire pressure warning light blinks slowly 3 times.

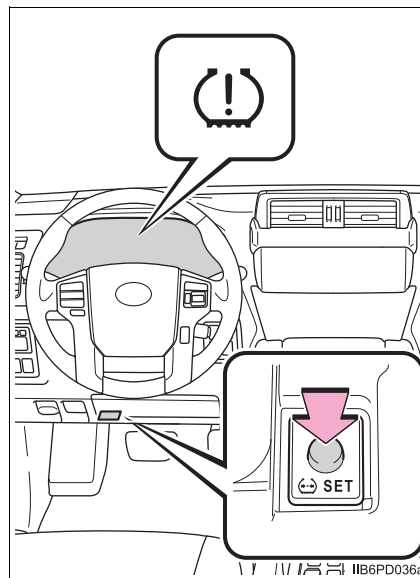

- 5 Vehicles without a smart entry & start system: Wait for a few minutes with the engine switch in the “ON” position and then turn the engine switch to the “ACC” or “LOCK” position.

Vehicles with a smart entry & start system: Wait for a few minutes with the engine switch in IGNITION ON mode and then turn the engine switch off.

◆ Registering ID codes

The tire pressure warning valve and transmitter is equipped with a unique ID code. When replacing a tire pressure warning valve and transmitter, it is necessary to register the ID code. Have the ID code registered by any authorized Toyota dealer or repairer, or another duly qualified and equipped professional.

■ When to replace your vehicle's tires

Tires should be replaced if:

- You have tire damage such as cuts, splits, cracks deep enough to expose the fabric, and bulges indicating internal damage
- A tire goes flat repeatedly or cannot be properly repaired due to the size or location of a cut or other damage

If you are not sure, consult with any authorized Toyota dealer or repairer, or another duly qualified and equipped professional.

■ Replacing tires and wheels (vehicles with the tire pressure warning system)

If the ID code of the tire pressure warning valve and transmitter is not registered, the tire pressure warning system will not work properly. After driving for about 10 minutes, the tire pressure warning light blinks for 1 minute and stays on to indicate a system malfunction.

■ Tire life

Any tire over 6 years old must be checked by a qualified technician even if it has seldom or never been used or damage is not obvious.

■ Routine tire inflation pressure checks (vehicles with the tire pressure warning system)

The tire pressure warning system does not replace routine tire inflation pressure checks. Make sure to check tire inflation pressure as part of your routine of daily vehicle checks.

■ If the tread on snow tires wears down below 4 mm (0.16 in.)

The effectiveness of the tires as snow tires is lost.

■ Situations in which the tire pressure warning system may not operate properly (if equipped)

- In the following cases, the tire pressure warning system may not operate properly.
 - If non-genuine Toyota wheels are used.
 - A tire has been replaced with a tire that is not an OE (Original Equipment) tire.
 - A tire has been replaced with a tire that is not of the specified size.
 - Tire chains etc. are equipped.
 - Lock nuts are equipped.
 - An auxiliary-supported run-flat tire is equipped.
 - If a window tint that affects the radio wave signals is installed.
 - If there is a lot of snow or ice on the vehicle, particularly around the wheels or wheel housings.
 - If the tire inflation pressure is extremely higher than the specified level.
 - If the spare tire is in a location subject to poor radio wave signal reception.*
 - If a large metallic object which can interfere with signal reception is put near the spare tire.*
 - If tires not equipped with the tire pressure warning valves and transmitters are used.
 - If the ID code on the tire pressure warning valves and transmitters is not registered in the tire pressure warning computer.
- *: Vehicles with the spare tire only
- Performance may be affected in the following situations.
 - Near a TV tower, electric power plant, gas station, radio station, large display, airport or other facility that generates strong radio waves or electrical noise
 - When carrying a portable radio, cellular phone, cordless phone or other wireless communication device
- When the vehicle is parked, the time taken for the warning to start or go off could be extended.
- When tire inflation pressure declines rapidly for example when a tire has burst, the warning may not function.

■ The initialization operation (vehicles with the tire pressure warning system)

- Make sure to carry out initialization after adjusting the tire inflation pressure. Also, make sure the tires are cold before carrying out initialization or tire inflation pressure adjustment.
- If you have accidentally turned the engine switch to the “LOCK” position (vehicles without a smart entry & start system) or off (vehicles with a smart entry & start system) during initialization, it is not necessary to press the reset switch again as initialization will restart automatically when the engine switch has been turned to the “ON” position (vehicles without a smart entry & start system) or IGNITION ON mode (vehicles with a smart entry & start system) for the next time.
- If you accidentally press the reset switch when initialization is not necessary, adjust the tire inflation pressure to the specified level when the tires are cold, and conduct initialization again.

■ Warning performance of the tire pressure warning system (if equipped)

The warning of the tire pressure warning system will change in accordance with the conditions under which it was initialized. For this reason, the system may give a warning even if the tire pressure does not reach a low enough level, or if the pressure is higher than the pressure that was adjusted to when the system was initialized.

■ When initialization of the tire pressure warning system has failed (if equipped)

Initialization can be completed in a few minutes. However, in the following cases, the settings have not been recorded and the system will not operate properly. If repeated attempts to record tire inflation pressure settings are unsuccessful, have the vehicle inspected by any authorized Toyota dealer or repairer, or another duly qualified and equipped professional.

- When operating the tire pressure warning reset switch, the tire pressure warning light does not blink 3 times.
- After driving for a certain period of time since the initialization has been completed, the warning light comes on after blinking for 1 minute.

■ Certification for tire pressure warning system

The latest “DECLARATION of CONFORMITY” (DoC) is available at the following:

DoC address:

<http://www.pacific-ind.co.jp/eng/products/car/tpms/doc/>

CE 0891

Hereby, PACIFIC INDUSTRIAL CO.,LTD., declares that this PMV-C210 is in compliance with the essential requirements and other relevant provisions of Directive 1999/5/EC.
PACIFIC INDUSTRIAL CO.,LTD. vakuuttaa täten että PMV-C210 tyyppinen laite on direktiivin 1999/5/EY oleellisten vaatimusten ja sitä koskevien direktiivin muiden ehtojen mukainen.
Hierbij verklaart PACIFIC INDUSTRIAL CO.,LTD. dat het toestel PMV-C210 in overeenstemming is met de essentiële eisen en de andere relevante bepalingen van richtlijn 1999/5/EG.
Par la présente PACIFIC INDUSTRIAL CO.,LTD. déclare que l'appareil PMV-C210 est conforme aux exigences essentielles et aux autres dispositions pertinentes de la directive 1999/5/CE.
Härmed intygar PACIFIC INDUSTRIAL CO.,LTD. att denna PMV-C210 står i överensstämmelse med de väsentliga egenskapskrav och övriga relevanta bestämmelser som framgår av direktiv 1999/5/EG.
Undertegnede PACIFIC INDUSTRIAL CO.,LTD. erklærer herved, at følgende udstyr PMV-C210 overholder de væsentlige krav og øvrige relevante krav i direktiv 1999/5/EF.
Hiermit erklärt PACIFIC INDUSTRIAL CO.,LTD., dass sich das Gerät PMV-C210 in Übereinstimmung mit den grundlegenden Anforderungen und den übrigen einschlägigen Bestimmungen der Richtlinie 1999/5/EG befindet.
ΜΕ ΤΗΝ ΠΑΡΟΥΣΑ PACIFIC INDUSTRIAL CO.,LTD. ΔΗΛΩΝΕΙ ΟΤΙ PMV-C210 ΣΥΜΜΟΡΦΩΝΕΤΑΙ ΠΡΟΣ ΤΙΣ ΟΥΣΙΩΔΕΙΣ ΑΠΑΙΤΗΣΕΙΣ ΚΑΙ ΤΙΣ ΛΟΙΠΕΣ ΣΧΕΤΙΚΕΣ ΔΙΑΤΑΞΕΙΣ ΤΗΣ ΟΔΗΓΙΑΣ 1999/5/ΕΚ.
Con la presente PACIFIC INDUSTRIAL CO.,LTD. dichiara che questo PMV-C210 è conforme ai requisiti essenziali ed alle altre disposizioni pertinenti stabilite dalla direttiva 1999/5/CE.

<p>Por medio de la presente PACIFIC INDUSTRIAL CO.,LTD. declara que el PMV-C210 cumple con los requisitos esenciales y cualesquiera otras disposiciones aplicables o exigibles de la Directiva 1999/5/CE.</p>
<p>PACIFIC INDUSTRIAL CO.,LTD. declara que este PMV-C210 está conforme com os requisitos essenciais e outras disposições da Directiva 1999/5/CE.</p>
<p>Hawnhekk, PACIFIC INDUSTRIAL CO.,LTD., jiddikjara li dan PMV-C210 jikkonforma mal-htigijiet essenzjali u ma provvedimentí oħrajn relevanti li hemm fid-Dirrettiva 1999/5/EC.</p>
<p>Käesolevaga kinnitab PACIFIC INDUSTRIAL CO.,LTD. seadme PMV-C210 vastavust direktiivi 1999/5/EÜ põhinõuetele ja nimetatud direktiivist tulenevatele teistele asjakohastele sätetele.</p>
<p>Alulírott, PACIFIC INDUSTRIAL CO.,LTD. nyilatkozom, hogy a PMV-C210 megfelel a vonatkozó alapvető követelményeknek és az 1999/5/EC irányelv egyéb előírásainak.</p>
<p>PACIFIC INDUSTRIAL CO.,LTD. týmto vyhlasuje, že PMV-C210 spĺňa základné požiadavky a všetky príslušné ustanovenia Smernice 1999/5/ES.</p>
<p>PACIFIC INDUSTRIAL CO.,LTD. tímto prohlašuje, že tento PMV-C210 je ve shodě se základními požadavky a dalšími příslušnými ustanoveními směrnice 1999/5/ES.</p>
<p>PACIFIC INDUSTRIAL CO.,LTD. izjavlja, da je ta PMV-C210 v skladu z bistvenimi zahtevami in ostalimi relevantnimi določili direktive 1999/5/ES.</p>
<p>Šiuo PACIFIC INDUSTRIAL CO.,LTD. deklaruoja, kad šis PMV-C210 atitinka esminius reikalavimus ir kitas 1999/5/EB Direktyvos nuostatas.</p>

Ar šo PACIFIC INDUSTRIAL CO.,LTD. deklarē, ka PMV-C210 atbilst Direktīvas 1999/5/EK būtiskajām prasībām un citiem ar to saistītajiem noteikumiem.
Niniejszym PACIFIC INDUSTRIAL CO.,LTD. oświadcza, że PMV-C210 jest zgodny z zasadniczymi wymogami oraz pozostałymi stosownymi postanowieniami Dyrektywy 1999/5/EC.
Hér með lýsir PACIFIC INDUSTRIAL CO.,LTD. yfir því að PMV-C210 er í samræmi við grunnkröfur og aðrar kröfur, sem gerðar eru í tilskipun 1999/5/EC.
PACIFIC INDUSTRIAL CO.,LTD. erklærer herved at utstyret PMV-C210 er i samsvar med de grunnleggende krav og øvrige relevante krav i direktiv 1999/5/EF.
С настоящето, PACIFIC INDUSTRIAL CO.,LTD., декларира, че PMV-C210 е в съответствие със съществените изисквания и другите приложими разпоредби на Директива 1999/5/EC.
Prin prezenta, PACIFIC INDUSTRIAL CO.,LTD., declară că aparatul PMV-C210 este în conformitate cu cerințele esențiale și cu alte prevederi pertinente ale Directivei 1999/5/CE.
Ovim, PACIFIC INDUSTRIAL CO.,LTD., izjavljuje da ovaj PMV-C210 je usklađen sa bitnim zahtjevima i drugim relevantnim odredbama Direktive 1999/5/EC.
Ovim PACIFIC INDUSTRIAL CO.,LTD., izjavljuje da je PMV-C210 u skladu s bitnim zahtjevima i drugim relevantnim odredbama Direktive 1999/5/EC i Pravilnika o RiTT opremi (NN 25/2012).
Me anë të kësaj, PACIFIC INDUSTRIAL CO, LTD., Deklaron se ky PMV-C210 është në përputhje me kërkesat themeloe dhe dispozitat e tjera përkatëse të direktivës 1999/5/EC.

The latest “DECLARATION of CONFORMITY” (DoC) is available at the following address:

<http://www.globaldenso.com/en/products/oem/index.html>



Hereby, DENSO CORPORATION declares that this 13BDX is in compliance with the essential requirements and other relevant provisions of Directive 1999/5/EC.
DENSO CORPORATION vakuuttaa täten että 13BDX tyyppinen laite on direktiivin 1999/5/EY oleellisten vaatimusten ja sitä koskevien direktiivin muiden ehtojen mukainen.
Hierbij verklaart DENSO CORPORATION dat het toestel 13BDX in overeenstemming is met de essentiële eisen en de andere relevante bepalingen van richtlijn 1999/5/EG.
Par la présente DENSO CORPORATION déclare que l'appareil 13BDX est conforme aux exigences essentielles et aux autres dispositions pertinentes de la directive 1999/5/CE.
Härmed intygar DENSO CORPORATION att denna 13BDX står i överensstämmelse med de väsentliga egenskapskrav och övriga relevanta bestämmelser som framgår av direktiv 1999/5/EG.
Undertegnede DENSO CORPORATION erklærer herved, at følgende udstyr 13BDX overholder de væsentlige krav og øvrige relevante krav i direktiv 1999/5/EF.
Hiermit erklart DENSO CORPORATION, dass sich das Gerät 13BDX in Übereinstimmung mit den grundlegenden Anforderungen und den übrigen einschlägigen Bestimmungen der Richtlinie 1999/5/EG befindet.
ΜΕ ΤΗΝ ΠΑΡΟΥΣΑ DENSO CORPORATION ΔΗΛΩΝΕΙ ΟΤΙ 13BDX ΣΥΜΜΟΡΦΩΝΕΤΑΙ ΠΡΟΣ ΤΙΣ ΟΥΣΙΩΔΕΙΣ ΑΠΑΙΤΗΣΕΙΣ ΚΑΙ ΤΙΣ ΛΟΙΠΕΣ ΣΧΕΤΙΚΕΣ ΔΙΑΤΑΞΕΙΣ ΤΗΣ ΟΔΗΓΙΑΣ 1999/5/ΕΚ.
Con la presente DENSO CORPORATION dichiara che questo 13BDX è conforme ai requisiti essenziali ed alle altre disposizioni pertinenti stabilite dalla direttiva 1999/5/CE.
Por medio de la presente DENSO CORPORATION declara que el 13BDX cumple con los requisitos esenciales y cualesquiera otras disposiciones aplicables o exigibles de la Directiva 1999/5/CE.
DENSO CORPORATION declara que este 13BDX está conforme com os requisitos essenciais e outras disposições da Directiva 1999/5/CE.
Hawnhekk, DENSO CORPORATION, jiddikjara li dan 13BDX jikkonforma mal-htigijiet essenzjali u ma provvedimenti oħrajn relevanti li hemm fid-Direttiva 1999/5/EC.
Käesolevaga kinnitab DENSO CORPORATION seadme 13BDX vastavust direktiivi 1999/5/EÜ põhinõuetele ja nimetatud direktiivist tulenevatele teistele asjakohastele sätetele.
Alulírott, DENSO CORPORATION nyilatkozom, hogy a 13BDX megfelel a vonatkozó alapvető követelményeknek és az 1999/5/EC irányelv egyéb előírásainak.
DENSO CORPORATION týmto vyhlasuje, že 13BDX splňa základné požiadavky a všetky príslušné ustanovenia Smernice 1999/5/ES.
DENSO CORPORATION tímto prohlašuje, že tento 13BDX je ve shodě se základními požadavky a dalšími příslušnými ustanoveními směrnice 1999/5/ES.
DENSO CORPORATION izjavlja, da je ta 13BDX v skladu z bistvenimi zahtevami in ostalimi relevantnimi določili direktive 1999/5/ES.

Šiuo DENSO CORPORATION deklaruoja, kad šis 13BDX atitinka esminius reikalavimus ir kitas 1999/5/EB Direktyvos nuostatas.
Ar šo DENSO CORPORATION deklārē, ka 13BDX atbilst Direktīvas 1999/5/EK būtiskajām prasībām un citiem ar to saistītajiem noteikumiem.
Niniejszym DENSO CORPORATION oświadcza, że 13BDX jest zgodny z zasadniczymi wymogami oraz pozostałymi stosownymi postanowieniami Dyrektywy 1999/5/EC.
Hér með lýsir DENSO CORPORATION yfir því að 13BDX er í samræmi við grunnkröfur og aðrar kröfur, sem gerðar eru í tilskipun 1999/5/EC.
DENSO CORPORATION erklærer herved at utstyret 13BDX er i samsvar med de grunnleggende krav og øvrige relevante krav i direktiv 1999/5/EF.
С настоящето, DENSO CORPORATION, декларира, че 13BDX е в съответствие със съществените изисквания и другите приложими разпоредби на Директива 1999/5/EC.
Prin prezenta, DENSO CORPORATION, declară că aparatul 13BDX este în conformitate cu cerințele esențiale și cu alte prevederi pertinente ale Directivei 1999/5/CE.
Ovim, DENSO CORPORATION, izjavljuje da ovaj 13BDX je usklađen sa bitnim zahtjevima i drugim relevantnim odredbama Direktive 1999/5/EC.
Ovim, DENSO CORPORATION, deklarise da je 13BDX u skladu sa osnovnim zahtevima i ostalim relevantnim odredbama Direktive 1999/5/EC.
Ovim DENSO CORPORATION, izjavljuje da je 13BDX u skladu s bitnim zahtjevima i drugim relevantnim odredbama Direktive 1999/5/EC i Pravilnika o RITT opremi (NN 25/2012).

► For vehicles sold in Serbia



**CAUTION****■ When inspecting or replacing tires**

Observe the following precautions to prevent accidents.

Failure to do so may cause damage to parts of the drive train as well as dangerous handling characteristics, which may lead to an accident resulting in death or serious injury.

- Do not mix tires of different makes, models or tread patterns.
Also, do not mix tires of remarkably different treadwear.
- Do not use tire sizes other than those recommended by Toyota.
- Do not mix differently constructed tires (radial, bias-belted or bias-ply tires).
- Do not mix summer, all season and snow tires.
- Do not use tires that have been used on another vehicle.
Do not use tires if you do not know how they were used previously.

■ When initializing the tire pressure warning system (if equipped)

Do not operate the tire pressure warning reset switch without first adjusting the tire inflation pressure to the specified level. Otherwise, the tire pressure warning light may not come on even if the tire inflation pressure is low, or it may come on when the tire inflation pressure is actually normal.

 NOTICE**■ Repairing or replacing tires, wheels, tire pressure warning valves, transmitters and tire valve caps (vehicles with the tire pressure warning system)**

- When removing or fitting the wheels, tires or the tire pressure warning valves and transmitters, contact any authorized Toyota dealer or repairer, or another duly qualified and equipped professional as the tire pressure warning valves and transmitters may be damaged if not handled correctly.
- Make sure to install the tire valve caps. If the tire valve caps are not installed, water could enter the tire pressure warning valves and the tire pressure warning valves could be bound.
- When replacing tire valve caps, do not use tire valve caps other than those specified. The cap may become stuck.

■ To avoid damage to the tire pressure warning valves and transmitters (vehicles with the tire pressure warning system)

When a tire is repaired with liquid sealants, the tire pressure warning valve and transmitter may not operate properly. If a liquid sealant is used, contact any authorized Toyota dealer or repairer, or another duly qualified and equipped professional or other qualified service shop as soon as possible. Make sure to replace the tire pressure warning valve and transmitter when replacing the tire. (→P. 541)

■ Driving on rough roads

Take particular care when driving on roads with loose surfaces or potholes. These conditions may cause losses in tire inflation pressure, reducing the cushioning ability of the tires. In addition, driving on rough roads may cause damage to the tires themselves, as well as the vehicle's wheels and body.

■ If tire inflation pressure of each tire becomes low while driving

Do not continue driving, or your tires and/or wheels may be ruined.

Tire inflation pressure

Make sure to maintain the proper tire inflation pressure. Tire inflation pressure should be checked at least once per month. However, Toyota recommends that tire inflation pressure be checked once every two weeks. (→P. 699)

■ Effects of incorrect tire inflation pressure

Driving with incorrect tire inflation pressure may result in the following:

- Reduced fuel efficiency
- Reduced driving comfort and tire life
- Reduced safety
- Damage to the drive train

If a tire needs frequent refilling, have it checked by any authorized Toyota dealer or repairer, or another duly qualified and equipped professional.

■ Instructions for checking tire inflation pressure

When checking tire inflation pressure, observe the following:

- Check only when the tires are cold.
If your vehicle has been parked for at least 3 hours and has not been driven for more than 1.5 km or 1 mile, you will get an accurate cold tire inflation pressure reading.
- Always use a tire pressure gauge.
The appearance of the tire can be misleading. In addition, tire inflation pressure that is even just a few pounds off can affect ride quality and handling.
- Do not reduce tire inflation pressure after driving. It is normal for tire inflation pressure to be higher after driving.
- Never exceed the vehicle capacity weight.
Passengers and luggage weight should be placed so that the vehicle is balanced.

 CAUTION**■ Proper inflation is critical to save tire performance**

Keep your tires properly inflated. Otherwise, the following conditions may occur and result in an accident causing death or serious injury:

- Excessive wear
- Uneven wear
- Poor handling
- Possibility of blowouts resulting from overheated tires
- Poor sealing of the tire bead
- Wheel deformation and/or tire separation
- A greater possibility of tire damage from road hazards

 NOTICE**■ When inspecting and adjusting tire inflation pressure**

Be sure to put the tire valve caps back on.

Without the valve caps, dirt or moisture could get into the valve and cause air leakage, which could result in an accident. If the caps have been lost, replace them as soon as possible.

Wheels

If a wheel is bent, cracked or heavily corroded, it should be replaced.

Otherwise, the tire may separate from the wheel or cause loss of handling control.

Wheel selection

When replacing wheels, care should be taken to ensure that they are equivalent to those removed in load capacity, diameter, rim width, and inset*.

Replacement wheels are available at any authorized Toyota dealer or repairer, or another duly qualified and equipped professional.

Toyota does not recommend using the following:

*: Conventionally referred to as "offset".

- Wheels of different sizes or types
- Used wheels
- Bent wheels that have been straightened

Aluminum wheel precautions (if equipped)

- Use only Toyota wheel nuts and wrenches designed for use with your aluminum wheels.
- When rotating, repairing or changing your tires, check that the wheel nuts are still tight after driving 1600 km (1000 miles).
- Be careful not to damage the aluminum wheels when using tire chains.
- When balancing your wheels, use only Toyota genuine balance weights or the equivalent. If clip-on balance weights are being used, use a plastic or rubber hammer to install the weight.

■ When replacing wheels (vehicles with the tire pressure warning system)

The wheels of your Toyota are equipped with tire pressure warning valves and transmitters that allow the tire pressure warning system to provide advance warning in the event of a loss in tire inflation pressure. Whenever wheels are replaced, tire pressure warning valves and transmitters must be installed. (→P. 541)

⚠ CAUTION

■ When replacing wheels

- Do not use wheels that are a different size from those recommended in the Owner's Manual, as this may result in loss of handling control.
- Never use an inner tube in a leaking wheel which is designed for a tubeless tire. Doing so may result in an accident, causing death or serious injury.

■ When installing the wheel nuts

- Be sure to install the wheel nuts with the tapered ends facing inward. Installing the nuts with the tapered ends facing outward can cause wheel to break and eventually cause the wheel to come off while driving, which could lead to an accident resulting in death or serious injury.

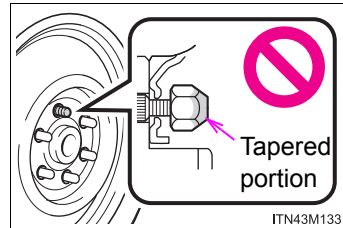

- Never use oil or grease on the wheel bolts or wheel nuts. Oil and grease may cause the wheel nuts to be excessively tightened, leading to bolt or disc wheel damage. In addition, the oil or grease can cause the wheel nuts to loosen and the wheel may fall off, causing an accident and resulting in death or serious injury. Remove any oil or grease from the wheel bolts or wheel nuts.

■ Use of defective wheels prohibited

Do not use cracked or deformed wheels. Doing so could cause the tire to leak air during driving, possibly causing an accident.



NOTICE

■ Replacing tire pressure warning valves and transmitters (vehicles with the tire pressure warning system)

- Because tire repair or replacement may affect the tire pressure warning valves and transmitters, make sure to have tires serviced by any authorized Toyota dealer or repairer, or another duly qualified and equipped professional or other qualified service shop. In addition, make sure to purchase your tire pressure warning valves and transmitters at any authorized Toyota dealer or repairer, or another duly qualified and equipped professional.
- Ensure that only genuine Toyota wheels are used on your vehicle. Tire pressure warning valves and transmitters may not work properly with non-genuine wheels.

Air conditioning filter

The air conditioning filter must be changed regularly to maintain air conditioning efficiency.

Removal method

- 1 Vehicles without a smart entry & start system:
Turn the engine switch to the "LOCK" position.
Vehicles with a smart entry & start system:
Turn the engine switch off.
- 2 Open the glove box. Slide off the damper.

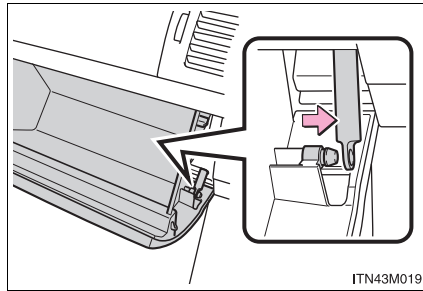

- 3 Push in each side of the glove box to disconnect the claws.

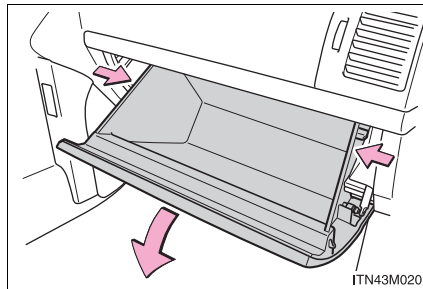

- 4 Remove the filter cover.

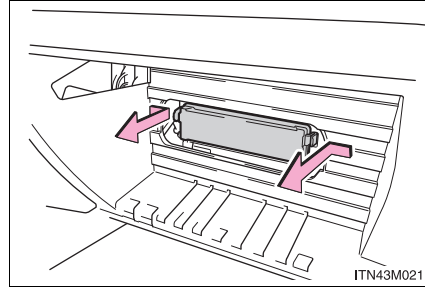

- 5 Replace it with a new one.
The “↑UP” marks shown on the filter should be pointing up.

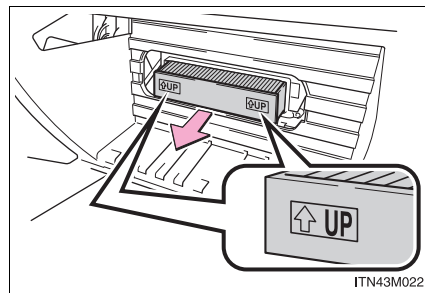

■ **Changing interval**

Inspect and replace the air conditioning filter according to the maintenance schedule. In dusty areas or areas with heavy traffic flow, early replacement may be required. (For scheduled maintenance information, please refer to the “Toyota Service Booklet” or “Toyota Warranty Booklet”.)

■ **If air flow from the vents decreases dramatically**

The filter may be clogged. Check the filter and replace if necessary.

⚠ NOTICE

■ **When using the air conditioning system**

Make sure that a filter is always installed.
Using the air conditioning system without a filter may cause damage to the system.

Wireless remote control/electronic key battery

Replace the battery with a new one if it is depleted.

You will need the following items:

- Flathead screwdriver
- Small flathead screwdriver (vehicles with a smart entry & start system)
- Lithium battery

Vehicles without a smart entry & start system (type A): CR2032

Vehicles without a smart entry & start system (type B): CR2016

Vehicles with a smart entry & start system: CR1632

Replacing the battery

- ▶ Vehicles without a smart entry & start system (type A)

- 1 Remove the cover using a coin protected with tape etc.

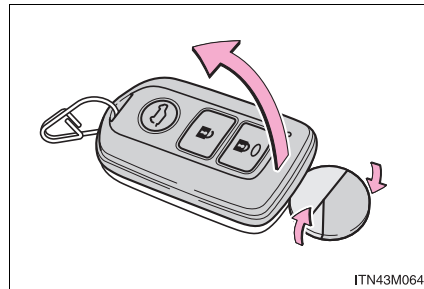

- 2 Remove the depleted battery using the tip of a ball-point pen or a similar pointed object.

Insert a new battery with the “+” terminal facing up.

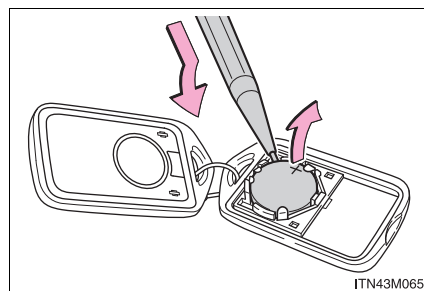

► Vehicles without a smart entry & start system (type B)

- 1 Remove the cover.

To prevent damage to the key, cover the tip of the screwdriver with a rag.

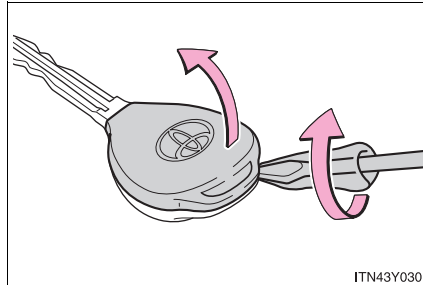

- 2 Remove the module.

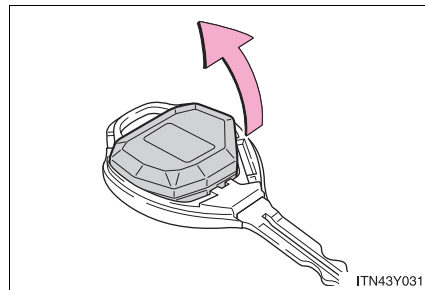

- 3 Open the case cover using a coin protected with tape etc. and remove the depleted battery.

Insert a new battery with the “+” terminal facing up.

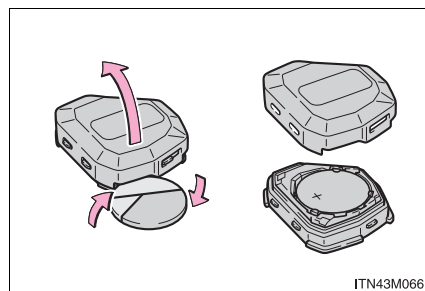

► Vehicles with a smart entry & start system

- 1 Take out the mechanical key.

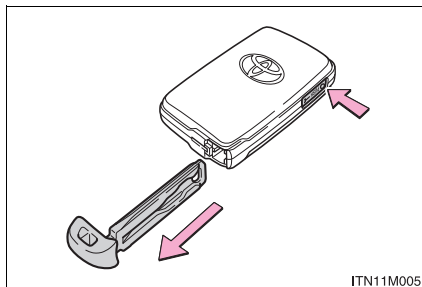

- 2 Remove the cover.

To prevent damage to the key, cover the tip of the screwdriver with a rag.

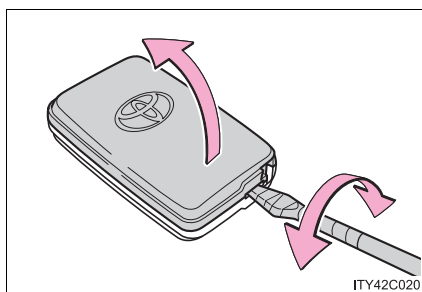

- 3 Remove the depleted battery.

Insert a new battery with the “+” terminal facing up.

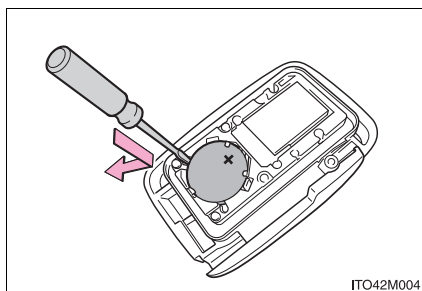

■ Use the following types of lithium battery

Vehicles without a smart entry & start system (type A): CR2032

Vehicles without a smart entry & start system (type B): CR2016

Vehicles with a smart entry & start system: CR1632

- Batteries can be purchased at any authorized Toyota dealer or repairer, or another duly qualified and equipped professional, local electrical appliance shops or camera stores.
- Replace only with the same or equivalent type recommended by the manufacturer.
- Dispose of used batteries according to the local laws.

■ If the key battery is depleted

The following symptoms may occur:

- The smart entry & start system (if equipped) and wireless remote control will not function properly.
- The operational range will be reduced.

 CAUTION**■ Removed battery and other parts**

These parts are small and if swallowed by a child, they can cause choking. Keep away from children. Failure to do so could result in death or serious injury.

■ Certification for the key battery

RISK OF EXPLOSION IF BATTERY IS REPLACED BY AN INCORRECT TYPE. DISPOSE OF USED BATTERIES ACCORDING TO THE INSTRUCTIONS.

 NOTICE**■ For normal operation after replacing the battery**

Observe the following precautions to prevent accidents:

- Always work with dry hands.
Moisture may cause the battery to rust.
- Do not touch or move any other component inside the remote control.
- Do not bend either of the battery terminals.

Checking and replacing fuses

If any of the electrical components do not operate, a fuse may have blown. If this happens, check and replace the fuses as necessary.

- 1 Vehicles without a smart entry & start system:
Turn the engine switch to the “LOCK” position.
Vehicles with a smart entry & start system:
Turn the engine switch off.

- 2 Open the fuse box cover.

- Engine compartment

Push the tab in and lift the lid off.

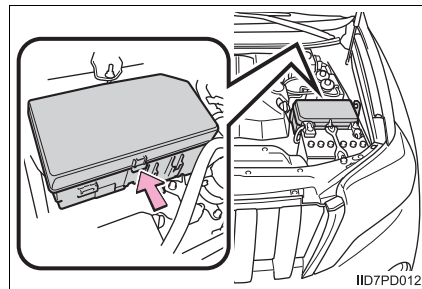

- Driver's side instrument panel

Remove the lid.

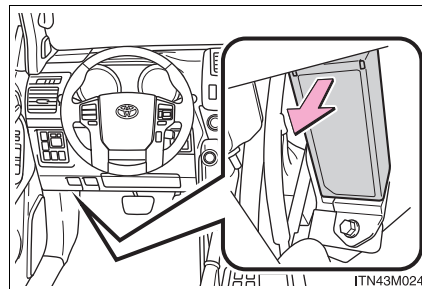

- 3 Remove the fuse with the pull-out tool.

Only type A fuse can be removed using the pullout tool.

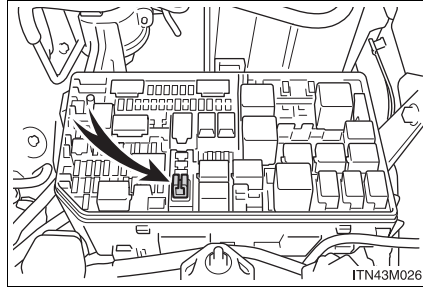

- 4 Check if the fuse is blown.

- ① Normal fuse

- ② Blown fuse

Type A

Replace the blown fuse with one of an appropriate amperage rating. The amperage rating can be found on the fuse box lid.

Type B, C, D and E

Contact any authorized Toyota dealer or repairer, or another duly qualified and equipped professional.

► Type A

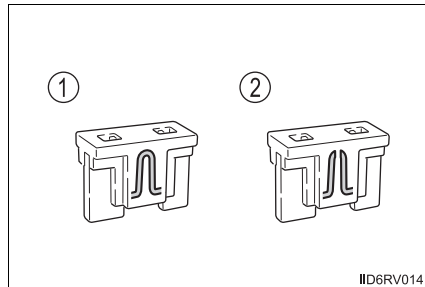

► Type B

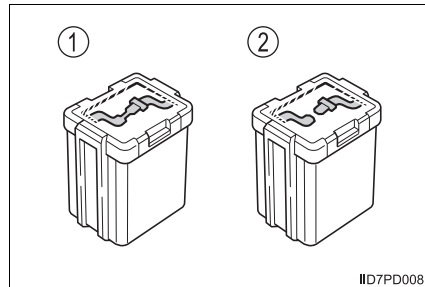

► Type C

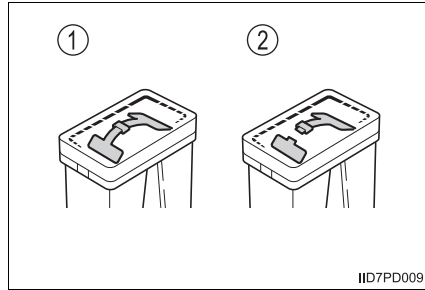

► Type D

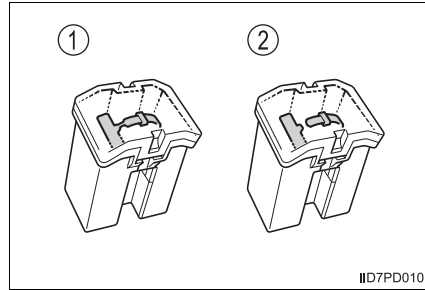

► Type E

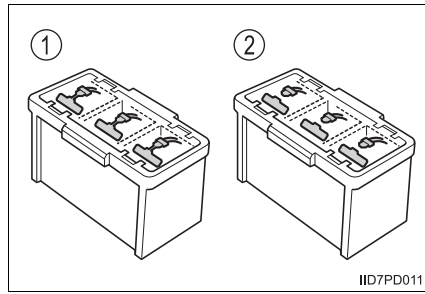

■ After a fuse is replaced

- If the lights do not turn on even after the fuse has been replaced, a bulb may need replacement. (→P. 568)
- If the replaced fuse blows again, have the vehicle inspected by any authorized Toyota dealer or repairer, or another duly qualified and equipped professional.

■ If there is an overload in a circuit

The fuses are designed to blow, protecting the wiring harness from damage.

 **CAUTION****■ To prevent system breakdowns and vehicle fire**

Observe the following precautions.

Failure to do so may cause damage to the vehicle, and possibly a fire or injury.

- Never use a fuse of a higher amperage rating than indicated, or use any other object in place of a fuse.
- Always use a genuine Toyota fuse or equivalent.
Never replace a fuse with a wire, even as a temporary fix.
- Do not modify the fuses or fuse boxes.

 **NOTICE****■ Before replacing fuses**

Have the cause of electrical overload determined and repaired by any authorized Toyota dealer or repairer, or another duly qualified and equipped professional as soon as possible.

Light bulbs

You may replace the following bulbs yourself. The difficulty level of replacement varies depending on the bulb. If necessary bulb replacement seems difficult to perform, contact any authorized Toyota dealer or repairer, or another duly qualified and equipped professional.

For more information about replacing other light bulbs, contact any authorized Toyota dealer or repairer, or another duly qualified and equipped professional.

Preparing for light bulb replacement

Check the wattage of the light bulb being replaced. (→P. 701)

Removing the engine compartment covers

→P. 524

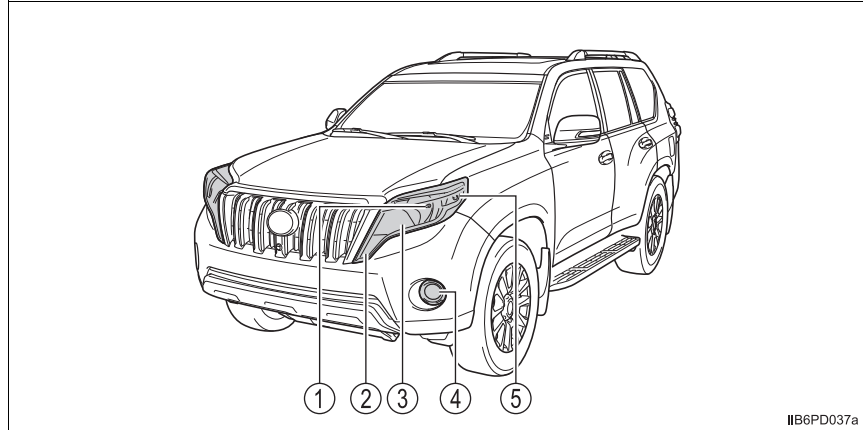
Bulb locations■ **Front**

- ① Headlight high beam
- ② Front position light
(halogen headlights)
- ③ Headlight low beam/daytime
running lights
(halogen headlights)
- ④ Front fog light (if equipped)
- ⑤ Front turn signal light

■ Rear

► Vehicles with under floor mounted spare tire

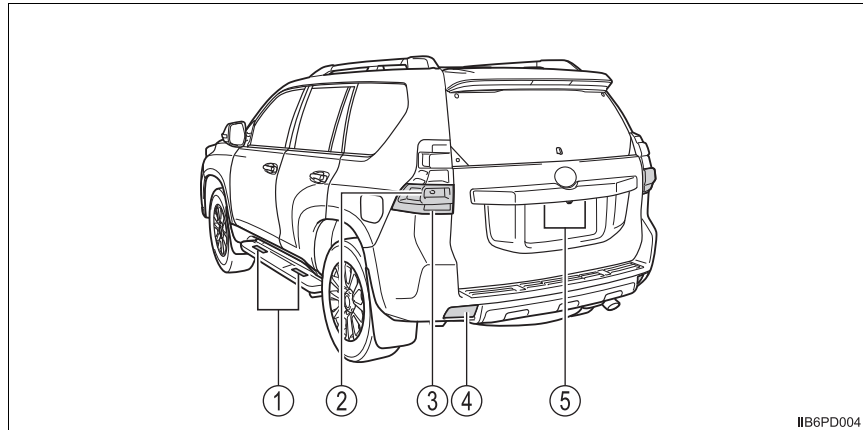

- | | |
|---|--------------------------------|
| ① Running board lights
(if equipped) | ③ Back-up light |
| ② Rear turn signal light | ④ Rear fog light (if equipped) |
| | ⑤ License plate lights |

► Vehicles with back door mounted spare tire

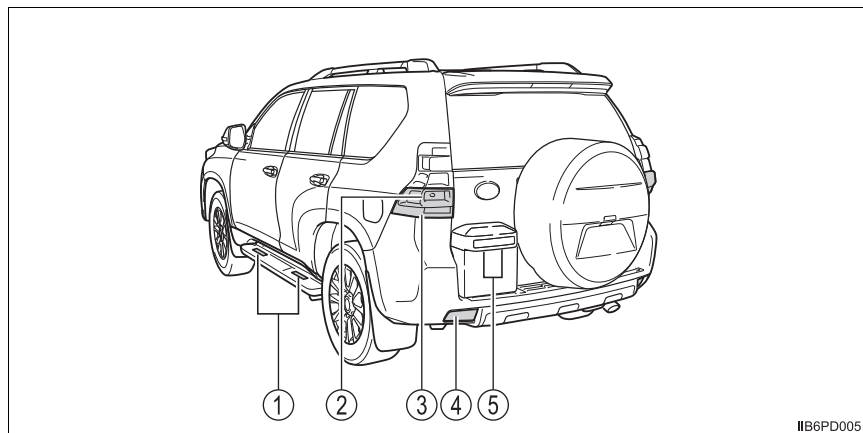

- | | |
|---|--------------------------------|
| ① Running board lights
(if equipped) | ③ Back-up light |
| ② Rear turn signal light | ④ Rear fog light (if equipped) |
| | ⑤ License plate lights |

Replacing light bulbs

■ Headlight low beams/daytime running lights (halogen headlights)

- 1 Turn the bulb base counter-clockwise.

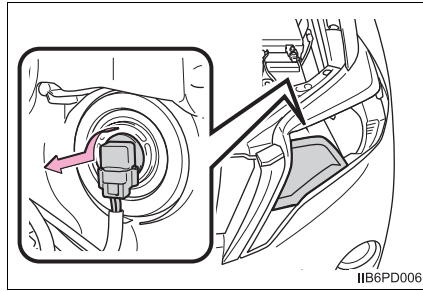

- 2 Unplug the connector while pushing the lock release.

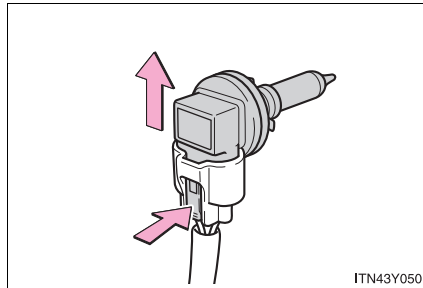

- 3 Replace the light bulb, and install the bulb base.

Align the 3 tabs on the light bulb with the mounting, and insert.

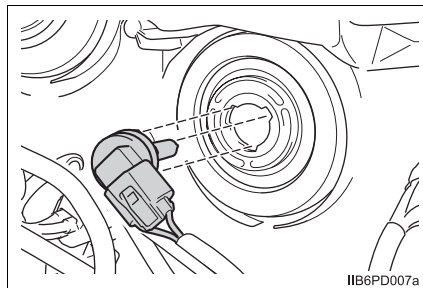

- 4 Turn and secure the bulb base.

Shake the bulb base gently to check that it is not loose, turn the headlights on once and visually confirm that no light is leaking through the mounting.

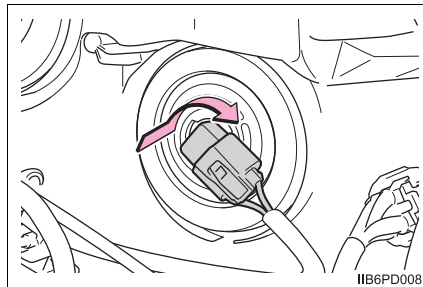

■ Headlight high beams

- 1 Turn the bulb base counter-clockwise.

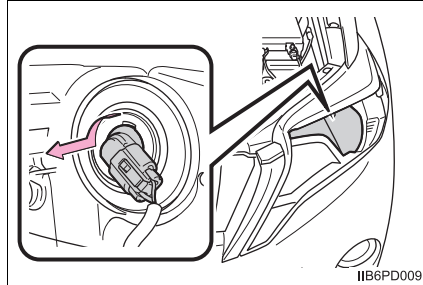

- 2 Unplug the connector while pushing the lock release.

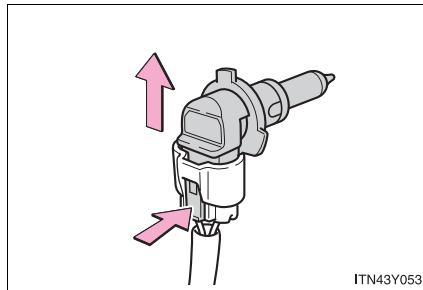

- 3 Replace the light bulb, and install the bulb base.

Align the 3 tabs on the light bulb with the mounting, and insert.

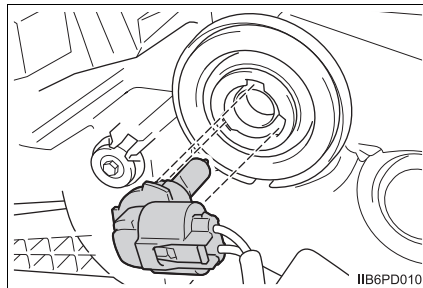

- 4 Turn and secure the bulb base.

Shake the bulb base gently to check that it is not loose, turn the headlights on once and visually confirm that no light is leaking through the mounting.

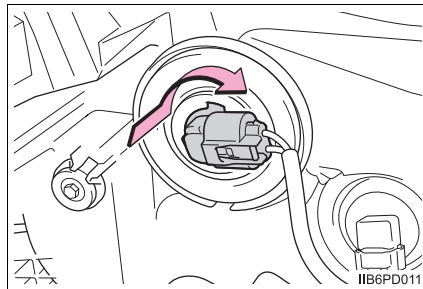

■ **Front position lights (halogen headlights)**

- 1 Turn the bulb base counter-clockwise.

The shape of the bulb base differs slightly on the left and right sides.

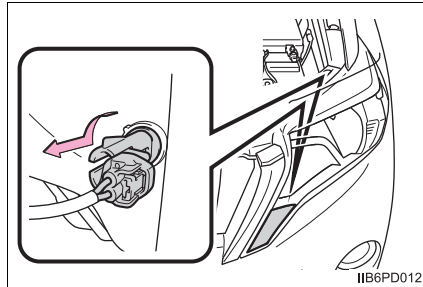

- 2 Remove the light bulb.

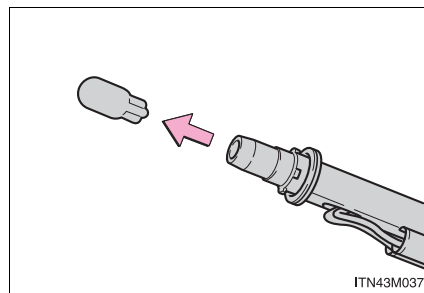

■ Front turn signal lights

- 1 Remove the fender liner bolts.

To allow enough working space, turn the steering wheel to the opposite side of the bulb to be replaced.

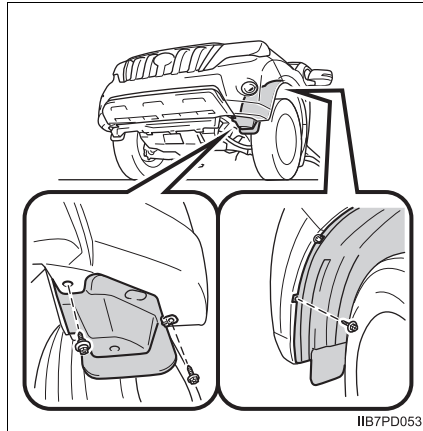

- 2 Open the fender liner.

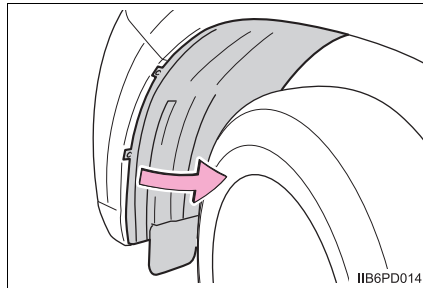

3 Turn the bulb base counterclockwise.

▶ Vehicles with halogen headlights

▶ Vehicles with LED headlights

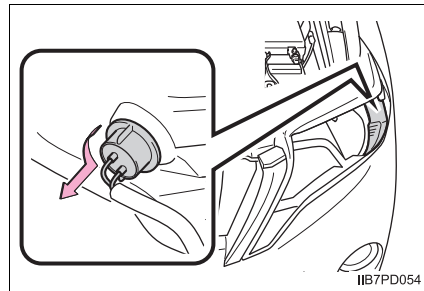
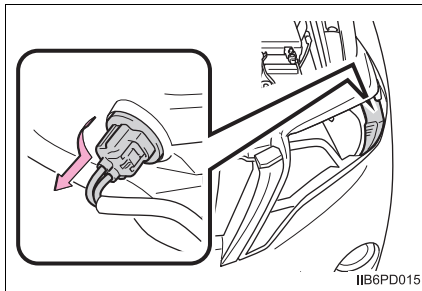

4 Remove the light bulb.

▶ Vehicles with halogen headlights

▶ Vehicles with LED headlights

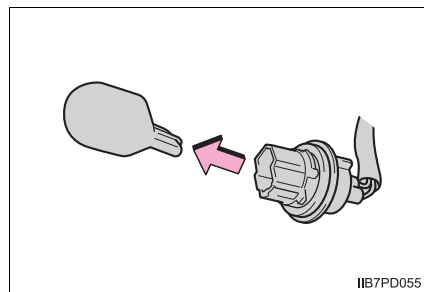
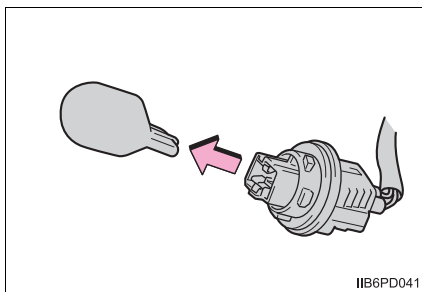

■ Front fog lights (if equipped)

- 1 Remove the fender liner bolts and open the fender liner.
(→P. 574)
- 2 Unplug the connector while pushing the lock release.

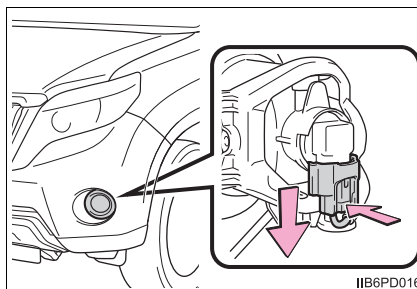

- 3 Turn the light bulb counter-clockwise.

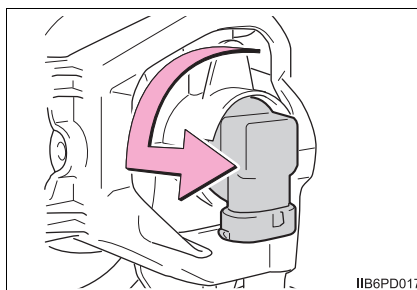

- 4 Replace the light bulb.
Align the 3 tabs on the light bulb with the mounting, and insert.

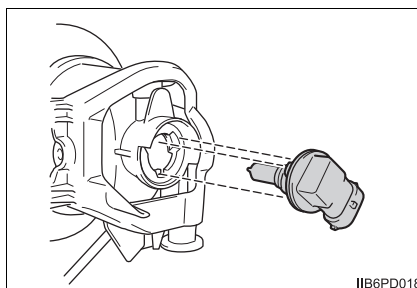

- 5 Turn and secure the bulb base.

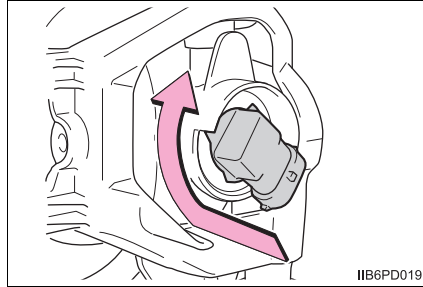

- 6 Install the bulb base.
Shake the bulb base gently to check that it is not loose, turn the fog lights on once and visually confirm that no light is leaking through the mounting.

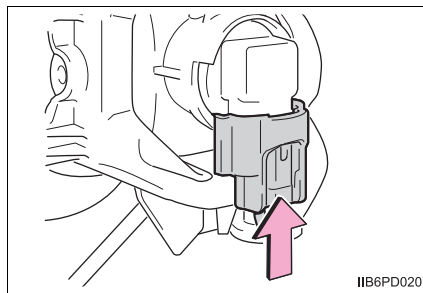

- 7 When installing the cover, conduct 1 in reverse.

■ Rear turn signal lights and back-up lights

1 Open the back door.

▶ Left-hand side

Remove the bolts and lamp assembly.

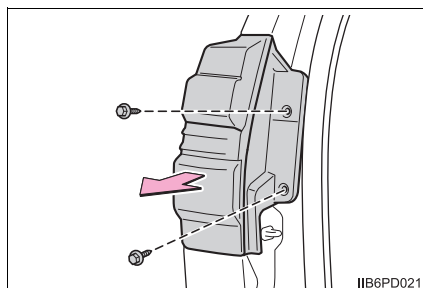

▶ Right-hand side

1 Remove the bolts.

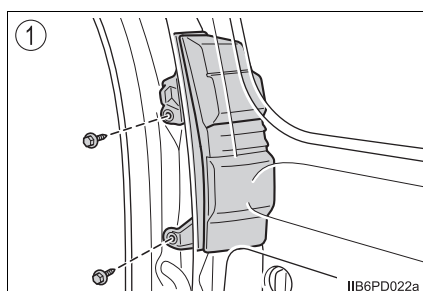

2 Close the back door half way and remove the lamp assembly.

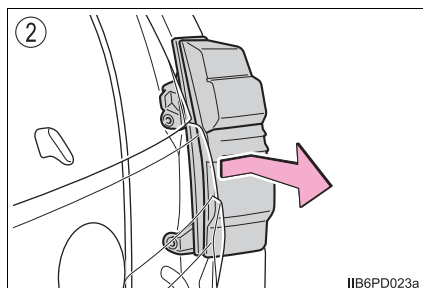

- 2 Unplug the connector while pushing the lock release.

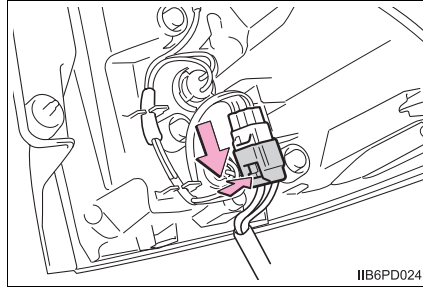

- 3 Turn the bulb bases counter-clockwise.

- 1 Rear turn signal light
- 2 Back-up light

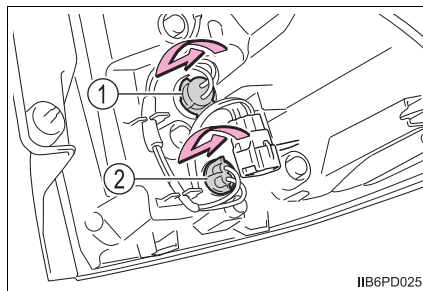

- 4 Remove the light bulb.

- 1 Rear turn signal light
- 2 Back-up light

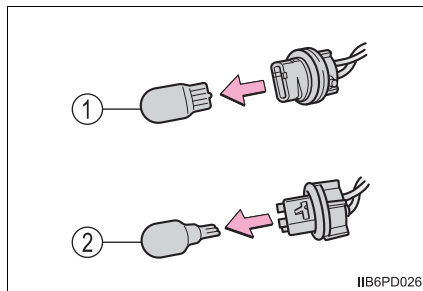

■ Rear fog lights (if equipped)

- 1 Remove the under cover bolts and pull down the under cover.

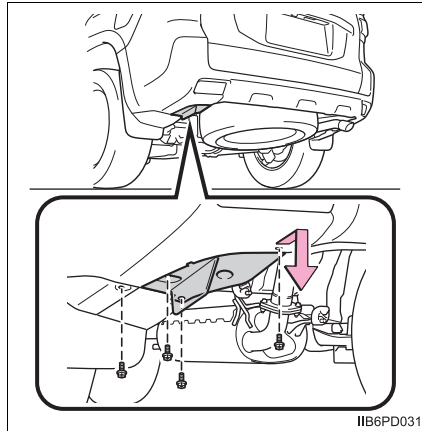

- 2 Turn the bulb base counter-clockwise.

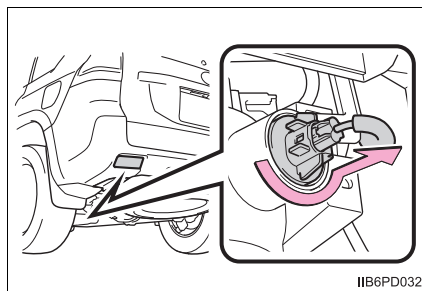

- 3 Remove the light bulb.

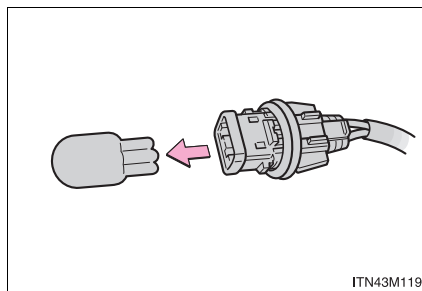

■ License plate lights

- ▶ Vehicles with under floor mounted spare tire and without spare tire

- 1 Remove the screws.
Remove the lens and the license plate light unit.

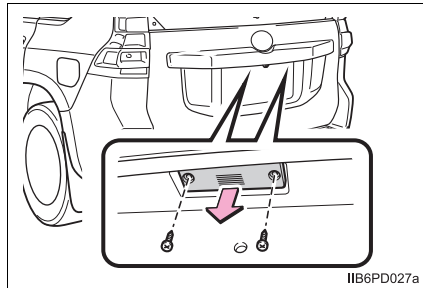

- 2 Remove the light bulb.

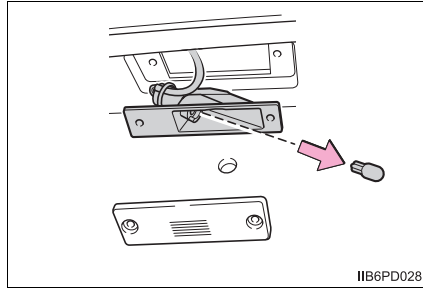

- ▶ Vehicles with back door mounted spare tire

- 1 Remove the screws.
Remove the lens and the license plate light unit.

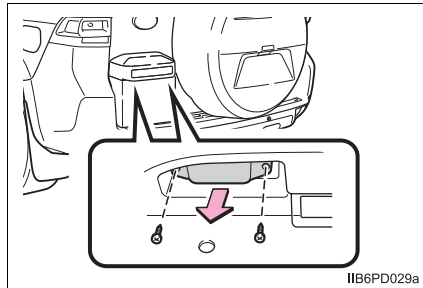

- 2 Remove the light bulb.

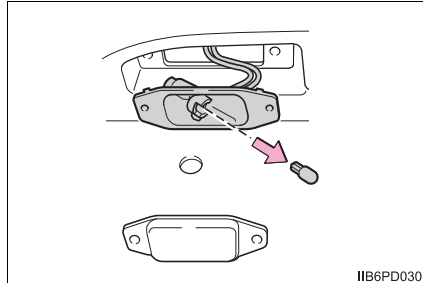

■ Running board lights (if equipped)

- 1 Turn the bulb bases counter-clockwise.

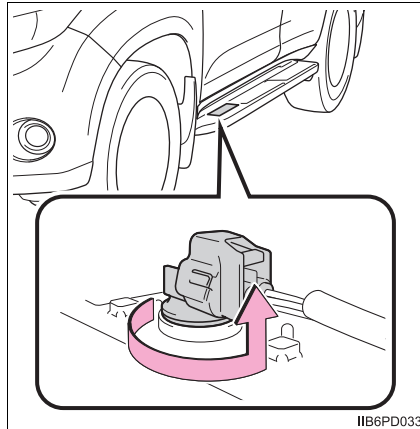

- 2 Remove the light bulb.

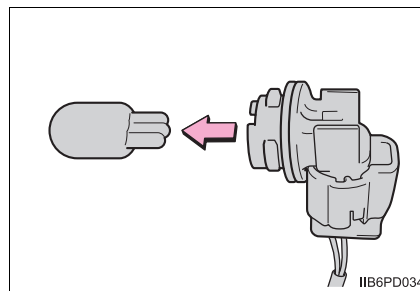
**■ Lights other than the above**

If any of the lights listed below has burnt out, have it replaced by any authorized Toyota dealer or repairer, or another duly qualified and equipped professional.

- Headlight low beams (LED headlights)
- Front position lights/daytime running lights (LED headlights)
- Side turn signal lights
- High mounted stoplight
- Stop/tail lights

■ LED lights

The headlight low beams (LED headlights), front position lights/daytime running lights (LED headlights), side turn signal lights, high mounted stoplight, stop/tail lights consist of a number of LEDs. If any of the LEDs burn out, take your vehicle to any authorized Toyota dealer or repairer, or another duly qualified and equipped professional to have the light replaced.

■ Condensation build-up on the inside of the lens

Temporary condensation build-up on the inside of the headlight lens does not indicate a malfunction. Contact any authorized Toyota dealer or repairer, or another duly qualified and equipped professional for more information in the following situations:

- Large drops of water are built up on the inside of the lens.
- Water has built up inside the headlight.

**CAUTION****■ Replacing light bulbs**

- Turn off the headlights. Do not attempt to replace the bulb immediately after turning off the headlights.
The bulbs become very hot and may cause burns.
- Do not touch the glass portion of the light bulb with bare hands. When it is unavoidable to hold the glass portion, use and hold with a clean dry cloth to avoid getting moisture and oils on the bulb.
Also, if the bulb is scratched or dropped, it may blow out or crack.
- Fully install light bulbs and any parts used to secure them. Failure to do so may result in heat damage, fire, or water entering the headlight unit. This may damage the headlights or cause condensation to build up on the lens.
- Do not attempt to repair or disassemble light bulbs, connectors, electric circuits or component parts.
Doing so may result in death or serious injury due to electric shock.

■ To prevent damage or fire

- Make sure bulbs are fully seated and locked.
- Check the wattage of the bulb before installing to prevent heat damage.

When trouble arises

8

8-1. Essential information

Emergency flashers	584
If your vehicle has to be stopped in an emergency	585

8-2. Steps to take in an emergency

If your vehicle needs to be towed	587
If you think something is wrong	592
Fuel pump shut off system (gasoline engine only)	593
If a warning light turns on or a warning buzzer sounds... ..	594
If a warning message is displayed	606
If you have a flat tire (vehicles with a spare tire)	622

If you have a flat tire (vehicles without a spare tire)	641
If the engine will not start	657
If the shift lever cannot be shifted from P (automatic transmission)	659
If the electronic key does not operate properly (vehicles with a smart entry & start system)	660
If the vehicle battery is discharged	663
If your vehicle overheats	669
If you run out of fuel and the engine stalls (diesel engine only)	672
If the vehicle becomes stuck	673

Emergency flashers

The emergency flashers are used to warn other drivers when the vehicle has to be stopped in the road due to a breakdown, etc.

Press the switch.

All the turn signal lights will flash.
To turn them off, press the switch
once again.

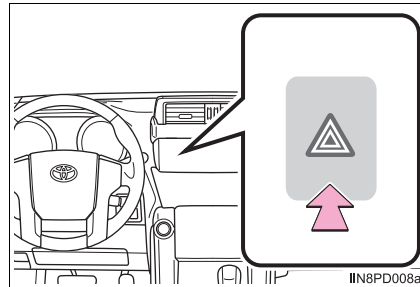

■ Emergency flashers

If the emergency flashers are used for a long time while the engine is not operating, the battery may discharge.

If your vehicle has to be stopped in an emergency

Only in an emergency, such as if it becomes impossible to stop the vehicle in the normal way, stop the vehicle using the following procedure:

- 1 Steadily step on the brake pedal with both feet and firmly depress it.
Do not pump the brake pedal repeatedly as this will increase the effort required to slow the vehicle.
- 2 Shift the shift lever to N.
 - ▶ If the shift lever is shifted to N
- 3 After slowing down, stop the vehicle in a safe place by the road.
- 4 Stop the engine.
 - ▶ If the shift lever cannot be shifted to N
- 3 Keep depressing the brake pedal with both feet to reduce vehicle speed as much as possible.
- 4 Vehicles without a smart entry & start system:
Stop the engine by turning the engine switch to the “ACC” position.

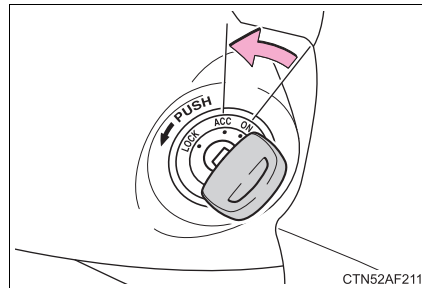

Vehicles with a smart entry & start system:

To stop the engine, press and hold the engine switch for 2 consecutive seconds or more, or press it briefly 3 times or more in succession.

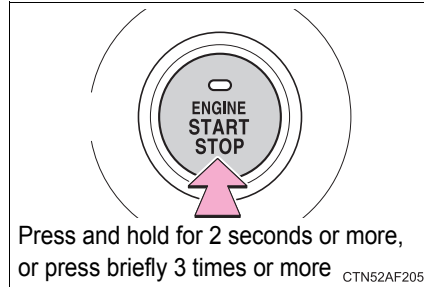

- 5 Stop the vehicle in a safe place by the road.

 CAUTION

■ **If the engine has to be turned off while driving**

- Power assist for the brakes and steering wheel will be lost, making the brake pedal harder to depress and the steering wheel heavier to turn. Decelerate as much as possible before turning off the engine.
- Vehicles without a smart entry & start system: Never attempt to remove the key, as doing so will lock the steering wheel.

If your vehicle needs to be towed

If towing is necessary, we recommend having your vehicle towed by any authorized Toyota dealer or repairer, or another duly qualified and equipped professional or a commercial towing service, using a lift-type truck or a flat bed truck. Use a safety chain system for all towing, and abide by all state/provincial and local laws.

Before towing

The following may indicate a problem with your transmission. Contact any authorized Toyota dealer or repairer, or another duly qualified and equipped professional before towing.

- The engine is running but the vehicle will not move.
- The vehicle makes an abnormal sound.

Emergency towing

If a tow truck is not available in an emergency, your vehicle may be temporarily towed using a cable or chain secured to the emergency towing hooks. This should only be attempted on hard surfaced roads for short distances at low speeds.

A driver must be in the vehicle to steer and operate the brakes. The vehicle's wheels, drive train, axles, steering and brakes must be in good condition.

For vehicles with an automatic transmission, only the front towing hooks may be used.

► Towing hook (front)

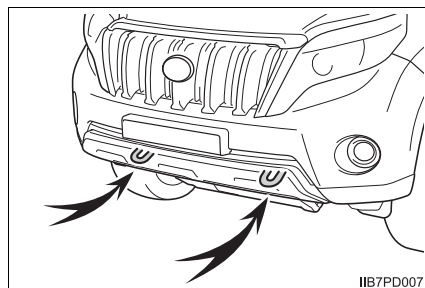

► Towing hook (rear)

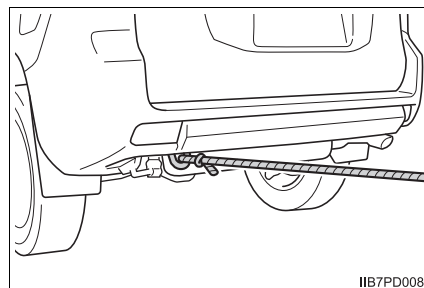

Towing with a sling-type truck

Do not tow with a sling type truck to prevent body damage.

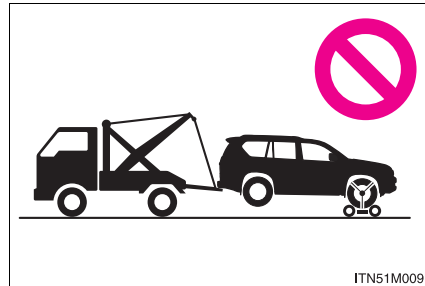

Towing with a wheel lift-type truck

► From the front

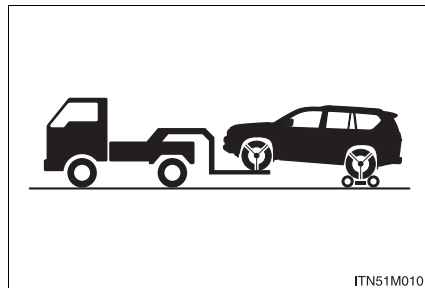

Use a towing dolly under the rear wheels.

► From the rear

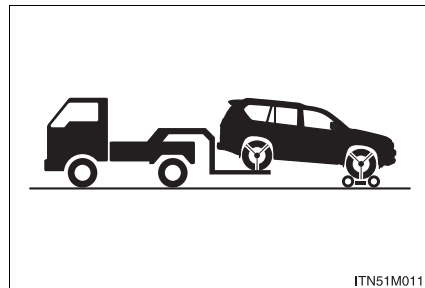

Use a towing dolly under the front wheels.

Using a flat bed truck

If your Toyota is transported by a flat bed truck, it should be tied down at the locations shown in the illustration.

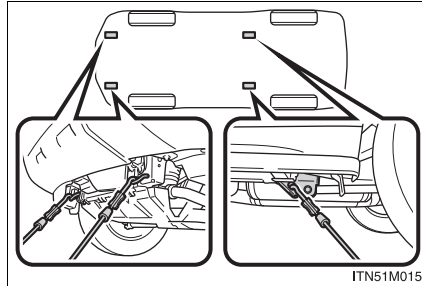

If you use chains or cables to tie down your vehicle, the angles shaded in black must be 45°.

Do not overly tighten the tie downs or the vehicle may be damaged.

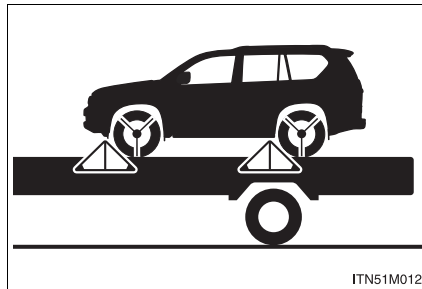

■ Before emergency towing

- 1 Vehicles without a smart entry & start system: Turn the engine switch to the "ON" (engine running) position.

Vehicles with a smart entry & start system: Turn the engine switch to IGNITION ON (engine running) mode.

- 2 2TR-FE engine: Put the four-wheel drive control switch in H4F. (The center differential is unlocked.)*

1GR-FE and 1KD-FTV engines: Put the four-wheel drive control switch in H4 and push the center differential lock/unlock switch to unlock the center differential.*

- 3 Vehicles with the rear height control air suspension: Put the vehicle height in the N mode and press the height control OFF button to turn off the rear height control air suspension.*

- 4 Shift the shift lever in N.

- 5 Release the parking brake.

*: Refer to the "Off-road Driving Owner's Manual"

 CAUTION**■ Caution while towing**

- Use extreme caution when towing the vehicle.
Avoid sudden starts or erratic driving maneuvers which place excessive stress on the emergency towing hooks and the cables or chains. Always be cautious of the surroundings and other vehicles while towing.
- Vehicles with a smart entry & start system:
Do not turn the engine switch off.
Doing so will lock the steering wheel and prevent operation, possibly causing an accident and resulting in death or serious injury.
- If the engine is not running, the power assist for the brakes and steering will not function, making steering and braking more difficult.

■ Before emergency towing (vehicles with rear height control air suspension)

When your vehicle is towed, put the vehicle height in the N mode and press the height control OFF button to turn off the rear height control suspension. Otherwise, the vehicle height may be changed in the automatic leveling function, resulting in an unexpected accident. For details, refer to the “Off-road driving Owner’s manual”.

 NOTICE**■ To prevent causing serious damage to the transmission and transfer when towing using a wheel-lift type truck**

Never tow this vehicle with any of the wheels in contact with the ground.

■ To avoid serious damage to your vehicle (vehicles with an automatic transmission)

Do not use the rear emergency towing hook.

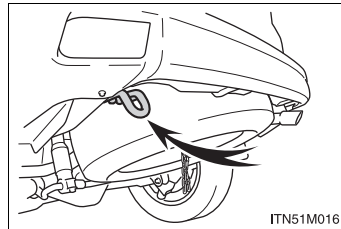
**■ To prevent damage to the vehicle when towing using a wheel-lift type truck**

When raising the vehicle, ensure adequate ground clearance for towing at the opposite end of the raised vehicle. Without adequate clearance, the vehicle could be damaged while being towed.

■ To prevent body damage when towing with a sling-type truck

Do not tow with a sling-type truck, either from the front or rear.

■ To prevent causing serious damage to the transmission and transfer in emergency towing (vehicles with an automatic transmission)

Never tow a vehicle from the rear with four wheels on the ground. This may cause serious damage to the transmission and transfer.

If you think something is wrong

If you notice any of the following symptoms, your vehicle probably needs adjustment or repair. Contact any authorized Toyota dealer or repairer, or another duly qualified and equipped professional as soon as possible.

Visible symptoms

- Fluid leaks under the vehicle
(Water dripping from the air conditioning after use is normal.)
- Flat-looking tires or uneven tire wear
- Engine coolant temperature gauge needle continually points higher than normal

Audible symptoms

- Changes in exhaust sound
- Excessive tire squeal when cornering
- Strange noises related to the suspension system
- Pinging or other noises related to the engine

Operational symptoms

- Engine missing, stumbling or running roughly
- Appreciable loss of power
- Vehicle pulls heavily to one side when braking
- Vehicle pulls heavily to one side when driving on a level road
- Loss of brake effectiveness, spongy feeling, pedal almost touches the floor

Fuel pump shut off system (gasoline engine only)

To minimize the risk of fuel leakage when the engine stalls or when an airbag inflates upon collision, the fuel pump shut off system stops the supply fuel to the engine.

Follow the procedure below to restart the engine after the system is activated.

▶ Vehicles without a smart entry & start system

- 1 Turn the engine switch to the “ACC” or “LOCK” position.
- 2 Restart the engine.

▶ Vehicles with a smart entry & start system

- 1 Turn the engine switch to ACCESSORY mode or turn it off.
- 2 Restart the engine.

 NOTICE

■ **Before starting the engine**





Inspect the ground under the vehicle.





If you find that fuel has leaked onto the ground, the fuel system has been damaged and is in need of repair. Do not restart the engine.





If a warning light turns on or a warning buzzer sounds





Calmly perform the following actions if any of the warning lights comes on or flashes. If a light comes on or flashes, but then goes off, this does not necessarily indicate a malfunction in the system. However, if this continues to occur, have the vehicle inspected by any authorized Toyota dealer or repairer, or another duly qualified and equipped professional.





Warning light and warning buzzer list





Warning light	Warning light/Details/Actions
	<p>Brake system warning light (warning buzzer)*1 Indicates that:</p> <ul style="list-style-type: none"> • The brake fluid level is low; or • The brake system is malfunctioning. <p>→ Immediately stop the vehicle in a safe place and contact any authorized Toyota dealer or repairer, or another duly qualified and equipped professional. Continuing to drive the vehicle may be dangerous.</p>
	<p>Charging system warning light Indicates a malfunction in the vehicle's charging system.</p> <p>→ Immediately stop the vehicle in a safe place and contact any authorized Toyota dealer or repairer, or another duly qualified and equipped professional.</p>
 <p>(If equipped)</p>	<p>Low engine oil pressure warning light Indicates that the engine oil pressure is too low</p> <p>→ Immediately stop the vehicle in a safe place and contact any authorized Toyota dealer or repairer, or another duly qualified and equipped professional.</p>
	<p>Malfunction indicator lamp Indicates a malfunction in:</p> <ul style="list-style-type: none"> • The electronic engine control system; • The electronic throttle control system; or • The electronic automatic transmission control system. <p>→ Have the vehicle inspected by any authorized Toyota dealer or repairer, or another duly qualified and equipped professional immediately.</p>

Warning light	Warning light/Details/Actions
	<p>SRS warning light Indicates a malfunction in:</p> <ul style="list-style-type: none"> • The SRS airbag system; or • The seat belt pretensioner system. <p>→ Have the vehicle inspected by any authorized Toyota dealer or repairer, or another duly qualified and equipped professional immediately.</p>
	<p>ABS warning light Indicates a malfunction in:</p> <ul style="list-style-type: none"> • The ABS; or • The brake assist system <p>→ Have the vehicle inspected by any authorized Toyota dealer or repairer, or another duly qualified and equipped professional immediately.</p>
	<p>Power steering system warning light Indicates a malfunction in the power steering system</p> <p>→ Have the vehicle inspected by any authorized Toyota dealer or repairer, or another duly qualified and equipped professional immediately.</p>
 <p>(Flashes) (if equipped)</p>	<p>Pre-crash safety system warning light Indicates a malfunction in the pre-crash safety system. The warning light will operate as follows, even when the system is not malfunctioning:</p> <ul style="list-style-type: none"> • The light will flash quickly when the system is operating. (→P. 379) • The light will turn on when the pre-crash braking is disabled. (→P. 380) • The light will turn on when the system cannot temporarily be used. (→P. 613) <p>→ Have the vehicle inspected by any authorized Toyota dealer or repairer, or another duly qualified and equipped professional immediately.</p>
 <p>(yellow) (if equipped)</p>	<p>Cruise control warning light Indicates a malfunction in the cruise control</p> <p>→ P. 295</p>

Warning light	Warning light/Details/Actions
	<p>Slip indicator light Indicates a malfunction in:</p> <ul style="list-style-type: none"> • The VSC system; • The trailer sway control system (If equipped); • The TRC system; • Active TRC system; • The downhill assist control system. (If equipped); • The hill-start assist control (If equipped); • The Multi-terrain Select (If equipped); • The Crawl Control. <p>The light will flash when any of the above systems other than the Multi-terrain Select are operating.</p> <p>→ Have the vehicle inspected by any authorized Toyota dealer or repairer, or another duly qualified and equipped professional immediately.</p>
 <p>(If equipped)</p>	<p>Automatic transmission fluid temperature warning light</p> <ul style="list-style-type: none"> • Indicates that the automatic transmission fluid temperature is too high if the light comes on. <p>→ Immediately stop the vehicle in a safe place, shift the shift lever to P and wait until the light goes off. If the light goes off, you may start the vehicle again. If the warning light do not go off, contact any authorized Toyota dealer or repairer, or another duly qualified and equipped professional.</p> <ul style="list-style-type: none"> • Indicates a malfunction in the automatic transmission system if the light flashes. <p>→ Immediately stop the vehicle in a safe place, shift the shift lever to P and contact any authorized Toyota dealer or repairer, or another duly qualified and equipped professional.</p>
 <p>(If equipped)</p>	<p>KDSS warning light Indicates a malfunction in KDSS</p> <p>→ Have the vehicle inspected by any authorized Toyota dealer or repairer, or another duly qualified and equipped professional immediately.</p>
 <p>(If equipped)</p>	<p>Timing belt replacement warning light Indicates that the timing belt should be replaced.</p> <p>→ Have the vehicle inspected by any authorized Toyota dealer or repairer, or another duly qualified and equipped professional.</p>

Warning light	Warning light/Details/Actions
 (If equipped)	Fuel filter warning light Indicates that the amount of accumulated water in the fuel filter has reached the specified level → P. 539
 (If equipped) (Comes on or flashes)	Fuel system warning light (warning buzzer) <ul style="list-style-type: none"> The amount of accumulated water in the fuel filter has reached the specified level if the light flashes. → P. 539 <ul style="list-style-type: none"> Malfunction in the fuel system if the light comes on. → Have the vehicle inspected by any authorized Toyota dealer or repairer, or another duly qualified and equipped professional immediately. The buzzer will sound at the same time the warning light flashes.
	Open door warning light (warning buzzer)*2 Indicates that a side door, the hood or the back door is not fully closed → Check that all the doors, the hood and the back door are closed.
	Low fuel level warning light Vehicles without sub fuel tank: Indicates that remaining fuel is approximately 13.0 L (3.4 gal., 2.8 Imp.gal.) or less if the light comes on. Vehicles with sub fuel tank: Indicates that remaining fuel is approximately 22.0 L (5.8 gal., 4.8 Imp.gal.) or less if the light comes on. 1KD-FTV models with sub fuel tank only: Indicates that remaining fuel is approximately 22.0 L (5.8 gal., 4.8 Imp.gal.) or less if the light flashes. → Refuel the vehicle.
	Driver's and front passenger's seat belt reminder light (warning buzzer)*3 Warns the driver and/or front passenger to fasten their seat belts → Fasten the seat belt. If the front passenger's seat is occupied, the front passenger's seat belt also needs to be fastened to make the warning light (warning buzzer) turn off.

Warning light	Warning light/Details/Actions
 (If equipped)	<p>Low engine oil level warning light Indicates that engine oil level is low → Check the level of engine oil and add more oil if necessary.</p>
 (If equipped)	<p>Master warning light A buzzer sounds and the warning light comes on and flashes to indicate that the master warning system has detected a malfunction. → P. 607</p>
 (If equipped)	<p>Tire pressure warning light When the light comes on: Low tire inflation pressure such as</p> <ul style="list-style-type: none"> • Natural causes (→P. 604) • Flat tire (→P. 623, 642) <p>→ Adjust the tire inflation pressure to the specified level.</p> <p>The light will turn off after a few minutes. In case the light does not turn off even if the tire inflation pressure is adjusted, have the system checked by any authorized Toyota dealer or repairer, or another duly qualified and equipped professional.</p> <p>When the light comes on after blinking for 1 minute: Malfunction in the tire pressure warning system → Have the system checked by any authorized Toyota dealer or repairer, or another duly qualified and equipped professional.</p>
 (If equipped)	<p>Low windshield washer fluid warning light Low level of washer fluid → Fill the tank.</p>
 (If equipped)	<p>LED headlight warning light Indicates a malfunction in the LED headlights The LED headlights will not normally illuminate when there is a malfunction, however it may be able to illuminate depending on the nature of the problem. → Have the vehicle inspected by any authorized Toyota dealer or repairer, or another duly qualified and equipped professional immediately.</p>



Warning light	Warning light/Details/Actions
 <p>(If equipped)</p>	<p>Automatic headlight leveling system warning light Indicates a malfunction in the automatic headlight leveling system → Have the vehicle inspected by any authorized Toyota dealer or repairer, or another duly qualified and equipped professional immediately.</p>
 <p>(Flashes) (If equipped)</p>	<p>Toyota parking assist-sensor indicator (warning buzzer)*4 Indicates a malfunction in Toyota parking assist-sensor → Have the vehicle inspected by any authorized Toyota dealer or repairer, or another duly qualified and equipped professional immediately.</p>
 <p>(If equipped)</p>	<p>Toyota parking assist-sensor indicator (warning buzzer)*5 Indicates that Toyota parking assist-sensor is dirty or covered with ice. → Clean the sensors.</p>
 <p>(If equipped)</p>	<p>DPF system warning light The amount of accumulated deposit in the DPF system has reached the specified level if the light comes on. Regenerate the filter. → P. 605 Malfunction in the DPF system if the light flashes. → Have the vehicle inspected by any authorized Toyota dealer or repairer, or another duly qualified and equipped professional immediately.</p>
 <p>(Flashes) (If equipped)</p>	<p>Engine oil change reminder light Indicates that the engine oil is scheduled to be changed: Flashes approximately 25000 km (15000 miles) after the engine oil is changed (the indicator will not work properly unless the oil maintenance data has been reset) → Check the engine oil and change if necessary. After changing the engine oil, the oil change system should be reset. (→P. 528)</p>



Warning light	Warning light/Details/Actions
 <p>(Remains on) (If equipped)</p>	<p>Engine oil change reminder light Indicates that the engine oil should be changed: Comes on approximately 30000 km (20000 miles) after the engine oil has been changed (and the oil maintenance data has been reset) → Have the engine oil and oil filter checked and/or changed by any authorized Toyota dealer or repairer, or another duly qualified and equipped professional. After changing the engine oil, the oil change system should be reset. (→P. 528)</p>

- *1: Parking brake engaged warning buzzer:
 A buzzer will sound if the vehicle is driven at a speed of approximately 5 km/h (3 mph) or more.
- *2: Open door warning buzzer:
 The open door warning buzzer sounds to alert one or more of the doors is not fully closed (with the vehicle having reached a speed of 5 km/h [3 mph]).
- *3: Driver's and front passenger's seat belt reminders:
 The driver's and front passenger's seat belts reminder sounds to alert the driver and front passenger that his/her seat belt is not fastened. The buzzer sounds for 30 seconds after the vehicle has reached a speed of at least 20 km/h (12 mph). Then, if the seat belt is still unfastened, the buzzer will sound in a different tone for 90 more seconds.
- *4: The corner and center indicators flash after the indicator for the malfunctioning sensor flashes and the vehicle indicator turns off while the buzzer sounds for approximately 8 seconds.
- *5: The corner and center indicators turn on and remain on after the indicator for the malfunctioning sensor turns on and the vehicle indicator turns off while the buzzer sounds for approximately 7 seconds.

Smart entry & start system warning light and buzzer procedures (If equipped)

After taking the specified steps to correct the suspected problem, check that the warning light turns off.

Interior buzzer	Exterior buzzer	Warning light	Details/Actions
Continuous	Continuous		Indicates that the driver's door was opened and closed while the electronic key was not in the vehicle, the shift lever was not in P (automatic transmission) or N (manual transmission) and the engine switch was not turned off. → Shift the shift lever to P. Bring the electronic key back into the vehicle.
Once	3 times		Indicates that the driver's door has been opened or closed with the engine switch in any mode other than off, the shift lever was in P (automatic transmission) or N (manual transmission) and the electronic key outside of the detection area. → Turn the engine switch off. Bring the electronic key back into the vehicle.
Once	Sounds once for 5 seconds	 (Comes on for about 60 seconds.)	Indicates that the engine switch in any mode other than off, the shift lever was in P (automatic transmission), the electronic key outside of the detection area and attempt to lock the vehicle with smart entry & start system. → Turn the engine switch off. Bring the electronic key back into the vehicle.

Interior buzzer	Exterior buzzer	Warning light	Details/Actions
Once	Sounds 3 times		Indicates that a door other than the driver's door has been opened or closed with the engine switch in any mode other than off, the shift lever was in P (automatic transmission) or N (manual transmission) and the electronic key outside of the detection area. → Turn the engine switch off. Bring the electronic key back into the vehicle.
Once	—		Indicates the electronic key is not present when attempting to start the engine. → Confirm the location of the electronic key

■ **Front passenger detection sensor and passenger seat belt reminder**

- If luggage is placed on the front passenger seat, the front passenger detection sensor may cause the warning light to flash, even if a passenger is not sitting in the seat.
- If a cushion is placed on the seat, the sensor may not detect a passenger, and the warning light may not operate properly.

■ **If the low speed four-wheel drive indicator light or the center differential lock indicator light blinks**

Take the specified steps. (→Refer to the “Off-road Driving Owner’s Manual”)

■ **When the tire pressure warning light comes on (vehicles with the tire pressure warning system)**

Inspect the appearance of the tire to check that the tire is not punctured.

If the tire is punctured: →P. 623, 642

If the tire is not punctured:

Carry out the following procedure after the tire temperature has lowered sufficiently.

- Check the tire inflation pressure and adjust to the appropriate level.
- If the warning light does not go out even after several minutes, check that the tire inflation pressure is at the specified level and carry out initialization.(→P. 542)

The warning light may come on again if the above operations are conducted without first allowing the tire temperature to lower sufficiently.

■ **The tire pressure warning light may come on due to natural causes (vehicles with the tire pressure warning system)**

The tire pressure warning light may come on due to natural causes such as natural air leaks and tire inflation pressure changes caused by temperature. In this case, adjusting the tire inflation pressure will turn off the warning light (after a few minutes).

■ **When a tire is replaced with a spare tire (vehicles with a compact spare tire and the tire pressure warning system)**

The tire pressure warning light will turn on if the tire inflation pressure of the spare tire is low. If a tire goes flat, the tire pressure warning light will not turn off even though the flat tire has been replaced with the spare tire.

■ **Conditions that the tire pressure warning system may not function properly (vehicles with the tire pressure warning system)**

→P. 544

■ **If the tire pressure warning light frequently comes on after blinking for 1 minute (vehicles with the tire pressure warning system)**

If the tire pressure warning light frequently comes on after blinking for 1 minute when the engine switch is turned to the "ON" position (vehicles without a smart entry & start system) or IGNITION ON mode (vehicles with a smart entry & start system), have it checked by any authorized Toyota dealer or repairer, or another duly qualified and equipped professional.

■ **Warning buzzer**

In some cases, the buzzer may not be heard because of noisy place or an audio sound.

■ **If the message “DPF FULL SEE OWNER’S MANUAL” appears on the display (if equipped)**

The deposit collected in the filter needs to be regenerated.

To regenerate the filter, the following driving methods are recommended*:

- By driving continuously (for example, at around 65 km/h [40 mph] for 20 to 30 minutes).
- By avoiding short trips, or by driving continuously (leaving the engine running for long periods of time).

The warning message will disappear when regeneration is complete. However, if this driving cannot be carried out, or if the message does not disappear even after driving, have the vehicle inspected by any authorized Toyota dealer or repairer, or another duly qualified and equipped professional immediately.

For details of the DPF system, refer to P. 266.

*: When driving, pay sufficient attention to weather, road conditions, terrain and traffic conditions, and drive according to traffic laws.

 CAUTION

■ **If both the ABS and the brake system warning lights remain on**

Stop your vehicle in a safe place immediately and contact any authorized Toyota dealer or repairer, or another duly qualified and equipped professional. The vehicle will become extremely unstable during braking, and the ABS system may fail, which could cause an accident resulting in death or serious injury.

■ **When the power steering system warning light comes on**

The steering wheel may become extremely heavy.
If the steering wheel becomes heavier than usual when operating, hold firmly and operate using more force than usual.

■ **If the tire pressure warning light comes on (vehicles with the tire pressure warning system)**

Be sure to observe the following precautions. Failure to do so could cause a loss of vehicle control and result in death or serious injury.

- Stop your vehicle in a safe place as soon as possible. Adjust the tire inflation pressure immediately.
- If the tire pressure warning light comes on even after tire inflation pressure adjustment, it is probable that you have a flat tire. Check the tires. If a tire is flat, change it with the spare tire and have the flat tire repaired by the nearest authorized Toyota dealer or repairer, or another duly qualified and equipped professional.
- Avoid abrupt maneuvering and braking. If the vehicle tires deteriorate, you could lose control of the steering wheel or the brakes.

■ **If a blowout or sudden air leakage should occur (vehicles with the tire pressure warning system)**

The tire pressure warning system may not activate immediately.

 NOTICE

■ **Precaution when installing a different tire (vehicles with the tire pressure warning system)**

When differently constructed tires or tires of different makers, models or tread patterns are installed, the tire pressure warning system may not operate properly.

■ **If the fuel filter warning light comes on**

Never drive the vehicle with the warning light on. Continued driving with water accumulated in the fuel filter will damage the fuel injection pump.

If a warning message is displayed*

The multi-information display shows warnings of system malfunctions, incorrectly performed operations, or shows messages that indicate a need for maintenance.





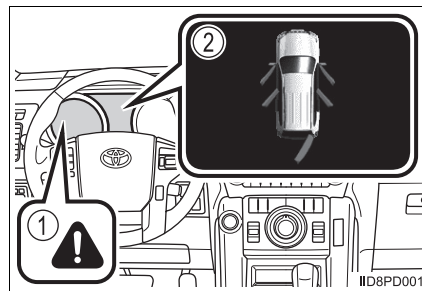



If a warning is shown on the multi-information display, stay calm and perform the following actions:



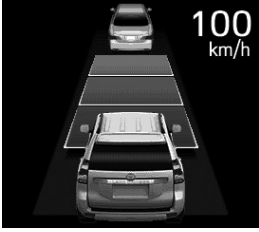
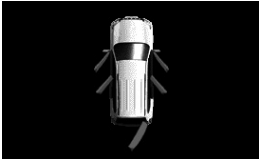





- ① Master warning light
The master warning light also comes on or flashes in order to indicate that a message is currently being displayed on the multi-information display.
- ② Multi-information display













If any of the warning lights comes on again after the following actions have been performed, contact any authorized Toyota dealer or repairer, or another duly qualified and equipped professional.







Warning message and warning buzzer list



Warning message	Details/Actions
 <p>BRAKE!</p>  <p>PCS (Flashes rapidly) (If equipped)</p>	<p>Indicates that:</p> <ul style="list-style-type: none"> • There is a high possibility of a frontal collision; or • The pre-crash braking function is operating <p>A buzzer also sounds. → Slow the vehicle by applying the brakes.</p>
 <p>100 km/h</p> <p>(If equipped)</p>	<p>Indicates that your vehicle is nearing the vehicle ahead (in vehicle-to-vehicle distance mode)</p> <p>A buzzer also sounds. → Slow the vehicle by applying the brakes.</p>
 	<p>Indicates that one or more of the doors is not fully closed</p> <p>The system also indicates which doors are not fully closed.</p> <p>If the vehicle reaches a speed of 5 km/h (3 mph),  flashes and a buzzer sounds to indicate that the door(s) are not yet fully closed. → Make sure that all the doors are closed.</p>
  <p>(If equipped)</p>	<p>Indicates that the glass hatch is not fully closed</p> <p>If the vehicle reaches a speed of 5 km/h (3 mph),  flashes and a buzzer sounds to indicate that the glass hatch is not yet fully closed. → Close the glass hatch.</p>



Warning message	Details/Actions
 <p>CHECK SONAR SYSTEM</p>  <p>(If equipped)</p>	<p>Indicates a malfunction in the Toyota parking assist-sensor</p> <p>All assist-sensors flash. A buzzer also sounds.</p> <p>→ Have the vehicle inspected by any authorized Toyota dealer or repairer, or another duly qualified and equipped professional.</p>
 <p>CLEAN SONAR</p>  <p>(If equipped)</p>	<p>Indicates that a Toyota parking assist-sensor is dirty or covered with ice</p> <p>A buzzer also sounds.</p> <p>→ Clean the sensor.</p>
<p>RELEASE PARKING BRAKE</p>   <p>(Flashes)</p>	<p>Indicates that the vehicle is being driven at 5 km/h (3 mph) or more with the parking brake still engaged</p> <p>A buzzer also sounds.</p> <p>→ Release the parking brake.</p>
<p>CLEAN RADAR SENSOR</p>  <p>(If equipped)</p>	<p>Indicates that the radar cruise control sensor is dirty or covered with ice</p> <p>A buzzer also sounds.</p> <p>→ Clean the grill and the sensor if they are dirty.</p>
<p>CRUISE CONTROL NOT AVAILABLE</p>  <p>(If equipped)</p>	<p>Indicates that the radar cruise control system is unable to judge vehicle-to-vehicle distance</p> <p>A buzzer also sounds.</p> <p>→ Turn off snow mode.</p> <p>If the windshield wipers are on, turn them off or set them to a mode other than AUTO or high speed wiper operation.</p>

Warning message	Details/Actions
<p>BSM NOT AVAILABLE</p>  <p>(If equipped)</p>	<p>Indicates that the BSM (Blind Spot Monitor) system sensor or the surrounding area on the bumper is dirty or covered with ice A buzzer also sounds. → Clean the sensor and its surrounding area on the bumper.</p>
<p>CHECK CRUISE CONTROL SYSTEM</p> 	<p>Indicates a malfunction in:</p> <ul style="list-style-type: none"> • The cruise control system; or • The dynamic radar cruise control system (if equipped) <p>Press the “ON/OFF” button once to deactivate the system, and then press the button again to reactivate the system. A buzzer also sounds. → Have the vehicle inspected by any authorized Toyota dealer or repairer, or another duly qualified and equipped professional.</p>
<p>CHECK STEERING LOCK SYSTEM</p>  <p>(If equipped)</p>	<p>Indicates a malfunction in the steering lock system A buzzer also sounds. → Have the vehicle inspected by any authorized Toyota dealer or repairer, or another duly qualified and equipped professional.</p>
<p>CHECK CLUTCH SWITCH</p>  <p>(If equipped)</p>	<p>Indicates a malfunction in the clutch switch system → Immediately stop the vehicle in a safe place and contact any authorized Toyota dealer or repairer, or another duly qualified and equipped professional.</p>
<p>CHECK PCS SYSTEM</p> <p>PCS </p> <p>(Flashes)</p> <p>(If equipped)</p>	<p>Indicates a malfunction in the PCS (Pre-Crash Safety system) A buzzer also sounds. → Have the vehicle inspected by any authorized Toyota dealer or repairer, or another duly qualified and equipped professional.</p>

Warning message	Details/Actions
<p>CHECK BSM SYSTEM</p>  <p>(If equipped)</p>	<p>Indicates a malfunction in the BSM (Blind Spot Monitor) system A buzzer also sounds. → Have the vehicle inspected by any authorized Toyota dealer or repairer, or another duly qualified and equipped professional.</p>
<p> ENGINE OIL PRESSURE LOW</p> 	<p>Indicates abnormal engine oil pressure The warning light may come on if the engine oil pressure is too low. A buzzer also sounds. → Immediately stop the vehicle in a safe place and contact any authorized Toyota dealer or repairer, or another duly qualified and equipped professional.</p>
<p>HIGH TRANSMISSION FLUID TEMPERATURE</p>  <p>(If equipped)</p>	<p>Indicates that the automatic transmission fluid temperature is too high A buzzer also sounds. → Immediately stop the vehicle in a safe place, shift the shift lever to P and wait until the warning message and light go off. If the warning message and light go off, you may start the vehicle again. If the warning message and light do not go off, contact any authorized Toyota dealer or repairer, or another duly qualified and equipped professional.</p>
<p>CHECK TRANSMISSION SYSTEM</p>  <p>(If equipped)</p>	<p>Indicates a malfunction in the automatic transmission system A buzzer also sounds. → Have the vehicle inspected by any authorized Toyota dealer or repairer, or another duly qualified and equipped professional.</p>
<p>MOONROOF OPEN</p>  <p>(Flashes) (If equipped)</p>	<p>Indicates that the moon roof is not fully closed (with the engine switch off, and the driver's door open) A buzzer also sounds. → Close the moon roof.</p>

Warning message	Details/Actions
<p>ENGINE OIL LOW</p> 	<p>Indicates that engine oil level is low A buzzer also sounds. → Check the level of engine oil, and add if necessary.</p>
<p>CHECK HEADLIGHT SYSTEM</p>   <p>(If equipped)</p>	<p>Indicates a malfunction in the LED headlights The LED headlights will not normally illuminate when there is a malfunction, however it may be able to illuminate depending on the nature of the problem A buzzer also sounds. → Have the vehicle inspected by any authorized Toyota dealer or repairer, or another duly qualified and equipped professional immediately.</p>
<p>CHECK HEADLIGHT SYSTEM</p>   <p>(If equipped)</p>	<p>Indicates a malfunction in the automatic headlight leveling system A buzzer also sounds. → Have the vehicle inspected by any authorized Toyota dealer or repairer, or another duly qualified and equipped professional immediately.</p>
<p>LOW WASHER FLUID</p> <p>(If equipped)</p>	<p>Indicates that the washer fluid level is low → Add washer fluid.</p>
<p>DRAIN WATER FROM FUEL FILTER</p>  <p>(If equipped)</p>	<p>Indicates that the amount of accumulated water in the fuel filter has reached the specified level A buzzer also sounds. → Drain the water from the fuel filter. (→P. 539)</p>
<p>CHECK FUEL SYSTEM</p> 	<p>Indicates that remaining fuel is approximately 10 L (2.6 gal., 2.2 Imp. gal.) or less A buzzer also sounds. → Refuel the vehicle.</p>

Warning message	Details/Actions
<p data-bbox="412 449 669 533">PCS TEMPORARILY NOT AVAILABLE</p>  <p data-bbox="493 606 586 632">(If equipped)</p>	<p data-bbox="688 415 1243 499">Indicates that the PCS (Pre-Crash Safety system) is not currently functional because the grille cover or the sensor is dirty</p> <p data-bbox="688 501 1243 642">→ • Check the grille cover and the sensor and clean them if they are dirty. • In case of overheating, the system will become functional once the system cools down.</p>
<p data-bbox="412 688 669 772">CHECK AIR SUSPENSION SYSTEM</p>  <p data-bbox="493 842 586 867">(If equipped)</p>	<p data-bbox="688 667 1243 751">Indicates a malfunction in the rear height control air suspension A buzzer also sounds.</p> <p data-bbox="688 753 1243 867">→ Immediately stop the vehicle in a safe place and contact any authorized Toyota dealer or repairer, or another duly qualified and equipped professional.</p>
<p data-bbox="412 909 669 1045">CRAWL NOT AVAILABLE SELECT L4 AND SHIFT TO D OR R POSITION</p> <p data-bbox="493 1058 586 1083">(If equipped)</p>	<p data-bbox="688 926 1243 1039">Indicates that the Crawl Control is not available → Select the four-wheel driving position switch in L4 and shift the shift lever to “D” or “R”.</p>
<p data-bbox="412 1119 669 1224">CRAWL NOT AVAILABLE CHECK SYSTEM OPERATION CONDITIONS</p> <p data-bbox="493 1234 586 1260">(If equipped)</p>	<p data-bbox="688 1136 1243 1220">Indicates that the Crawl Control is not available → Confirm the operating conditions of the Crawl Control.</p>
<p data-bbox="412 1308 669 1381">CRAWL HAS BEEN DEACTIVATED</p>  <p data-bbox="493 1461 586 1486">(If equipped)</p>	<p data-bbox="688 1276 1243 1360">Indicates that the Crawl Control is canceled while in use A buzzer also sounds.</p> <p data-bbox="688 1362 1243 1503">→ Use Crawl Control under the proper operating conditions. Refer to the “Off-road Driving Owner’s Manual” for more information regarding Crawl Control.</p>

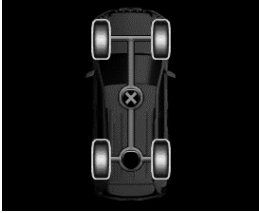
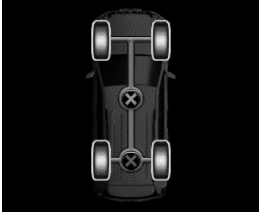
Warning message	Details/Actions
<p data-bbox="412 432 669 543">FUEL FILTER MAINTENANCE REQUIRED</p>  <p data-bbox="496 621 586 642">(If equipped)</p>	<p data-bbox="691 443 1154 495">Indicates a malfunction in the fuel system A buzzer also sounds.</p> <p data-bbox="691 499 1243 611">→ Have the vehicle inspected by any authorized Toyota dealer or repairer, or another duly qualified and equipped professional immediately.</p>
<p data-bbox="412 674 669 743">T-BELT MAINTENANCE REQUIRED</p>  <p data-bbox="496 831 586 852">(If equipped)</p>	<p data-bbox="691 663 1243 716">Indicates that the timing belt is scheduled to be changed.</p> <p data-bbox="691 720 1243 831">→ Have the timing belt checked and/or changed by any authorized Toyota dealer or repairer, or another duly qualified and equipped professional.</p>
 <p data-bbox="496 1104 586 1125">(If equipped)</p>	<p data-bbox="691 873 1243 926">Indicates a malfunction in the four-wheel drive system if the light continues flashing</p> <p data-bbox="691 930 1243 1104">→ Immediately stop the vehicle in a safe place and contact any authorized Toyota dealer or repairer, or another duly qualified and equipped professional. Refer to the "Off-road Driving Owner's Manual".</p>
 <p data-bbox="496 1377 586 1398">(If equipped)</p>	<p data-bbox="691 1146 1243 1199">Indicates a malfunction in the rear differential lock system if the light continues flashing</p> <p data-bbox="691 1203 1243 1377">→ Immediately stop the vehicle in a safe place and contact any authorized Toyota dealer or repairer, or another duly qualified and equipped professional. Refer to the "Off-road Driving Owner's Manual".</p>
<p data-bbox="412 1430 669 1583">OPERATION NOT POSSIBLE WHEN MULTI-TERRAIN SELECT ACTIVATED</p> <p data-bbox="496 1593 586 1614">(If equipped)</p>	<p data-bbox="691 1419 1243 1493">Indicates that the VSC OFF switch is pressed or second start mode is selected while the Multi-terrain Select system is in use</p> <p data-bbox="691 1497 1243 1608">→ While the Multi-terrain Select system is in use, vehicle stability control cannot be turned off and second start mode cannot be activated.</p>

Warning message	Details/Actions
<p>MULTI-TERRAIN SELECT HAS BEEN CANCELLED</p> <p>(If equipped)</p>	<p>Indicates that the Multi-terrain Select system is canceled while in use A buzzer also sounds. → Use the Multi-terrain Select system under the proper operating conditions.</p>
<p>OPERATION NOT POSSIBLE WHEN CRAWL CONTROL ACTIVATED</p> <p>(If equipped)</p>	<p>Indicates that the Multi-terrain Select system is turned on during Crawl Control operation → Turn Crawl Control off before turning on the Multi-terrain Select system.</p>
<p>SHIFT TO L4</p> <p>(If equipped)</p>	<p>Indicates that the Multi-terrain Select system is turned on while the transfer switch is in H4 → Turn the transfer switch to L4.</p>
<p>STOP THE VEHICLE AND SHIFT THE AUTOMATIC TRANSMISSION TO N</p> <p>(If equipped)</p>	<p>Indicates that the transfer switch is turned from H4 to L4 while the shift lever is not in N → Move the shift lever to N.</p>
<p>MULTI-TERRAIN SELECT NOT AVAILABLE</p> <p>(If equipped)</p>	<p>Indicates that the VSC, the 4WD system, the Multi-terrain Select system or the EFI system malfunctions → Consult any authorized Toyota dealer or repairer, or another duly qualified and equipped professional.</p>
<p>OIL MAINTENANCE REQUIRED SOON</p>	<p>Indicates that the engine oil is scheduled to be changed Comes on approximately 25000 km (15000 miles) after the engine oil is changed. (The indicator will not work properly unless the oil maintenance data has been reset.) → Check the engine oil and change if necessary. After changing the engine oil, the oil change system should be reset. (→P. 528)</p>

Warning message	Details/Actions
<p style="text-align: center;">OIL MAINTENANCE REQUIRED</p>	<p>Indicates that the engine oil and oil filter should be changed → Have the engine oil and oil filter checked and/or changed by any authorized Toyota dealer or repairer, or another duly qualified and equipped professional. After changing the engine oil, the oil change system should be reset. (→P. 528)</p>
<p style="text-align: center;">DPF FULL SEE OWNER'S MANUAL</p> <p style="text-align: center;"><small>(If equipped)</small></p>	<p>Indicates that the amount of accumulated deposit in the DPF system has reached the specified level if the light comes on. Regenerate the filter. → P. 617</p>
<p style="text-align: center;">DPF FULL ENGINE SERVICE REQUIRED</p> <p style="text-align: center;"><small>(If equipped)</small></p>	<p>Malfunction in the DPF system if the light flashes. → Have the vehicle inspected by any authorized Toyota dealer or repairer, or another duly qualified and equipped professional immediately.</p>

■ **Warning message in radar cruise mode (vehicles with the Dynamic radar cruise control system)**

In the following situations, the warning message may not be displayed even if vehicle-to-vehicle distance decreases:

- When your vehicle and the vehicle ahead are traveling at the same speed or the vehicle ahead is traveling more quickly than your vehicle
- When the vehicle ahead is traveling at a very low speed
- Immediately after cruise control speed is set
- At the instant the accelerator pedal is depressed

■ **Conditions that the tire pressure warning system may not function properly (vehicles with the tire pressure warning system)**

→P. 544

■ **If the message “DPF FULL SEE OWNER’S MANUAL” appears on the display (if equipped)**

The deposit collected in the filter needs to be regenerated.

To regenerate the filter, the following driving methods are recommended*:

- By driving continuously (for example, at around 65 km/h [40 mph] for 20 to 30 minutes).
- By avoiding short trips, or by driving continuously (leaving the engine running for long periods of time).



The warning message will disappear when regeneration is complete. However, if this driving cannot be carried out, or if the message does not disappear even after driving, have the vehicle inspected by any authorized Toyota dealer or repairer, or another duly qualified and equipped professional immediately.



For details of the DPF system, refer to P. 266.



*: When driving, pay sufficient attention to weather, road conditions, terrain and traffic conditions, and drive according to traffic laws.



■ **Warning buzzer**



In some cases, the buzzer may not be heard due to being in a noisy location or audio sound.

Interior buzzer	Exterior buzzer	Warning message	Details/Actions
Once	3 times	<p>KEY NOT DETECTED</p>  <p>(Flashes)</p>	<p>The electronic key was carried outside the vehicle and a door other than the driver's door was opened and closed while the engine switch was in a mode other than off.</p> <p>→ Bring the electronic key back into the vehicle.</p> <p>The driver's door was opened and closed while the electronic key was not in the vehicle, the shift lever was in P and the engine switch was not turned off.</p> <p>→ Turn the engine switch off. Bring the electronic key back into the vehicle.</p>
Once	Sounds once for 5 seconds	<p>KEY NOT DETECTED</p> <p>TURN POWER OFF</p>  <p>(Flashes)</p>	<p>An attempt was made to exit the vehicle with the electronic key and lock the doors without first turning the engine switch off.</p> <p>→ Turn the engine switch off and lock the doors again.</p>
Once	—	<p>KEY NOT DETECTED</p>  <p>(Flashes)</p>	<ul style="list-style-type: none"> • An attempt was made to start the engine without the electronic key being present, or the electronic key was not functioning normally. • An attempt was made to drive when the regular key was not inside the vehicle. <p>→ Confirm that the electronic key is inside the vehicle.</p>

Interior buzzer	Exterior buzzer	Warning message	Details/Actions
Con- tinu- ous	—	<p>SHIFT TO P POSITION</p>  <p>(Flashes)</p> <p>(If equipped)</p>	<p>The driver's door was opened when the shift lever was not in P and the engine switch was not turned off.</p> <p>→ Shift the shift lever to P.</p>
Con- tinu- ous	Con- tinu- ous	<p>SHIFT TO P POSITION</p> <p>KEY NOT DETECTED</p> <p>(Displayed alternately)</p>  <p>(Flashes)</p>	<p>The driver's door was opened and closed while the electronic key was not in the vehicle, the shift lever was not in P and the engine switch was not turned off.</p> <p>→ Shift the shift lever to P. Bring the electronic key back into the vehicle.</p>
Once	Sounds once for 5 sec- onds	<p>KEY DETECTED IN VEHICLE</p>  <p>(Flashes)</p>	<p>An attempt was made to lock the doors using the smart entry & start system while the electronic key was still inside the vehicle.</p> <p>→ Retrieve the electronic key from the vehicle and lock the doors again.</p>

Interior buzzer	Exterior buzzer	Warning message	Details/Actions
Once	Sounds once for 5 seconds	<p>KEY DETECTED IN VEHICLE</p>  <p>(Flashes)</p>	<p>An attempt was made to lock either front door by opening a door and putting the inside lock button into the lock position, then closing the door by pulling on the outside door handle with the electronic key still inside the vehicle.</p> <p>→ Retrieve the electronic key from the vehicle and lock the doors again.</p>
Once	—	<p>DEPRESS BRAKE PEDAL, TOUCH ENGINE SWITCH WITH KEY</p> <p>(automatic transmission) or</p> <p>DEPRESS CLUTCH PEDAL, TOUCH ENGINE SWITCH WITH KEY</p> <p>(manual transmission)</p>  <p>(Flashes)</p>	<ul style="list-style-type: none"> • When the doors were unlocked with the mechanical key and then the engine switch was pressed, the electronic key could not be detected in the vehicle. • The electronic key could not be detected in the vehicle even after the engine switch was pressed two consecutive times. <p>→ Touch the electronic key to the engine switch while depressing the brake pedal (automatic transmission) or clutch pedal (manual transmission).</p>
Once	—	<p>SHIFT TO P POSITION AND PUSH ENGINE SWITCH TO TURN POWER OFF</p> 	<p>An attempt was made to turn the engine switch off when the shift lever was not in P.</p> <p>→ To turn off the engine, first shift the shift lever to P and then turn the engine switch off.</p>

Interior buzzer	Exterior buzzer	Warning message	Details/Actions
—	—	<p>AUTO POWER OFF TO CONSERVE BATTERY</p>	<p>Power was turned off due to the automatic power off function.</p> <p>→ Next time when starting the engine, increase the engine speed slightly and maintain that level for approximately 5 minutes to recharge the battery.</p>
Once	—	<p>KEY BATTERY LOW</p> 	<p>The electronic key has a low battery.</p> <p>→ Replace the electronic key battery. (→P. 560)</p>
Once	—	<p>DEPRESS BRAKE PEDAL AND PUSH ENGINE SWITCH TO START</p> <p>(automatic transmission) or</p> <p>DEPRESS CLUTCH PEDAL AND PUSH ENGINE SWITCH TO START</p> <p>(manual transmission)</p>  (Flashes)	<p>The driver's door was opened and closed with the engine switch turned off and then the engine switch was put in ACCESSORY mode twice without the engine being started.</p> <p>→ Press the engine switch while depressing the brake pedal (automatic transmission) or clutch pedal (manual transmission).</p> <p>During an engine starting procedure in the event that the electronic key was not functioning properly (→P. 662), the engine switch was touched with the electronic key.</p> <p>→ Press the engine switch within 10 seconds of the buzzer sounding.</p>

Interior buzzer	Exterior buzzer	Warning message	Details/Actions
Once	—	<p>STEERING LOCK ACTIVE</p>  <p>(Flashes)</p>	<p>The steering lock could not be released within 3 seconds of the engine switch being pressed.</p> <p>→ Press the engine switch while depressing the brake pedal and moving the steering wheel left and right.</p>
Once	—	<p>SHIFT TO P POSITION TO START</p>  <p>(Flashes)</p>	<p>An attempt was made to start the engine with the shift lever in an incorrect position.</p> <p>→ Shift the shift lever to P and start the engine.</p>
Once	—	<p>SHIFT TO P POSITION AND PUSH ENGINE SWITCH TO TURN POWER OFF</p>  <p>(Flashes)</p>	<p>An attempt was made to turn the engine switch off when the shift lever was not in P.</p> <p>→ To turn off the engine, first shift the shift lever to P and then turn the engine switch off.</p>

■ Warning buzzer

In some cases, the buzzer may not be heard due to being in a noisy location or audio sound.

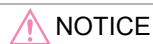

NOTICE

■ While the engine oil level warning is displayed

Continued engine operation with low engine oil will damage the engine.

If you have a flat tire (vehicles with a spare tire)

Remove the flat tire and replace it with the spare provided.
For details about tires: →P. 540

CAUTION

■ If you have a flat tire

Do not continue driving with a flat tire.
Driving even a short distance with a flat tire can damage the tire and the wheel beyond repair, which could result in an accident.

Before jacking up the vehicle

- Stop the vehicle on a hard, flat surface.
- Set the parking brake.
- Shift the shift lever to P (automatic transmission) or R (manual transmission).
- Turn off the rear height control air suspension (if equipped). (→Refer to the “Off-road Driving Owner’s Manual”)
- Stop the engine.
- Turn on the emergency flashers. (→P. 585)

Location of the spare tire, jack and tools

- Vehicles with under floor mounted spare tire

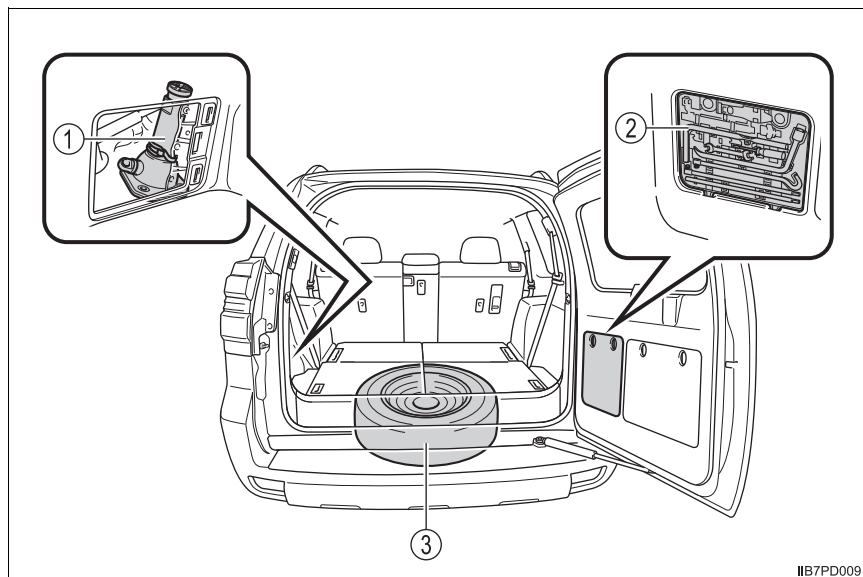

- ① Jack
- ② Tool box
- ③ Spare tire

► Vehicles with back door mounted spare tire

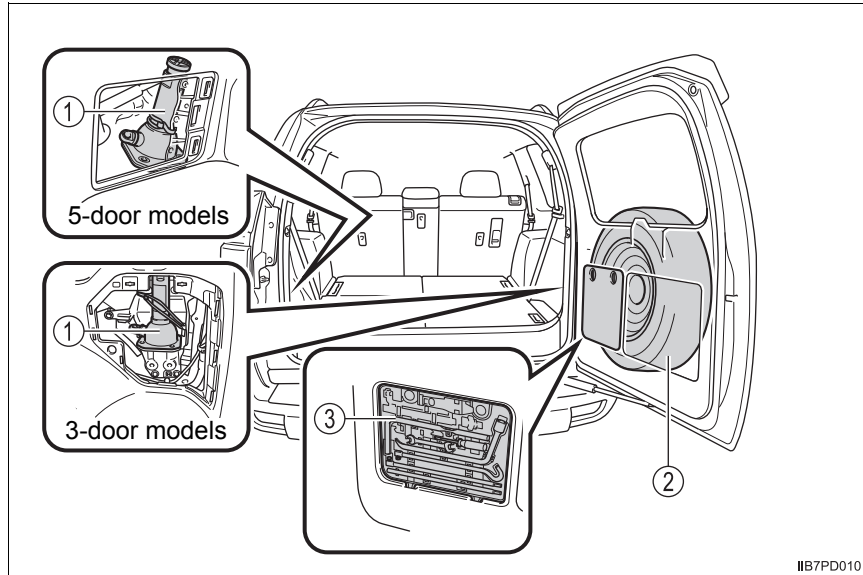

- ① Jack
- ② Spare tire
- ③ Tool box

IIB7PD010

 CAUTION**■ Using the tire jack**

Improper use of the tire jack may cause the vehicle to suddenly fall off the jack, leading to death or serious injury.

- Do not use the tire jack for any purpose other than replacing tires or installing and removing tire chains.
- Only use the tire jack that comes with this vehicle for replacing a flat tire. Do not use it on other vehicles, and do not use other tire jacks for replacing tires on this vehicle.
- Always check that the tire jack is securely set to the jack point.
- Do not put any part of your body under the vehicle while it is supported by the jack.
- Do not start or run the engine while your vehicle is supported by the jack.
- Do not raise the vehicle while someone is inside.
- When raising the vehicle, do not put an object on or under the jack.
- Do not raise the vehicle to a height greater than that required to replace the tire.
- Use a jack stand if it is necessary to get under the vehicle.
- Vehicles with rear height control air suspension: Be sure to turn off the height control and stop the engine.

Take particular care when lowering the vehicle to ensure that no one working on or near the vehicle will be injured.

■ Using the jack handle

Tighten all the jack handle bolts securely using a Phillips-head screwdriver, to prevent the extension parts from coming apart unexpectedly.

Taking out the jack

1 Remove the cover.

▶ 3-door models

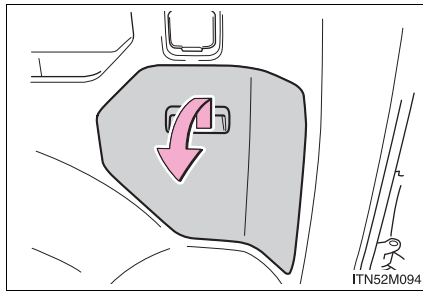

▶ 5-door models

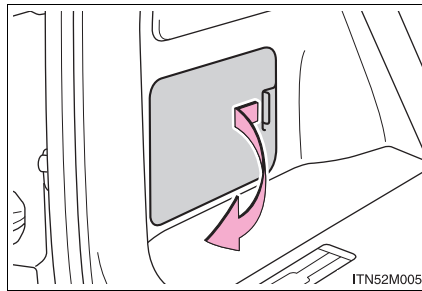

2 Unhook the rubber band and take out the jack.

① For loosening

② For tightening

▶ 3-door models

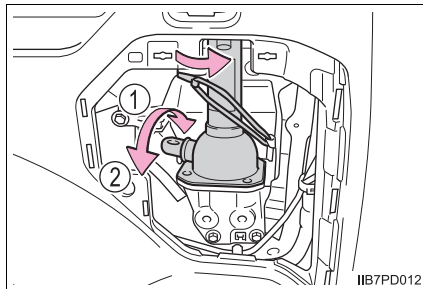

▶ 5-door models

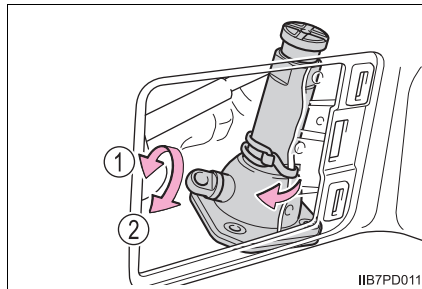

Taking out the tool box

- 1 Open the cover.

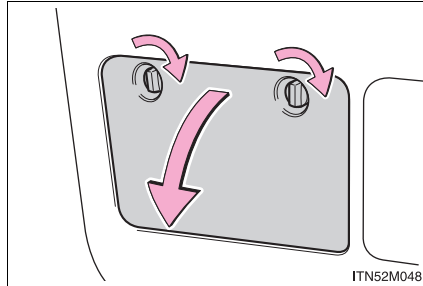

- 2 Take out the tool box.

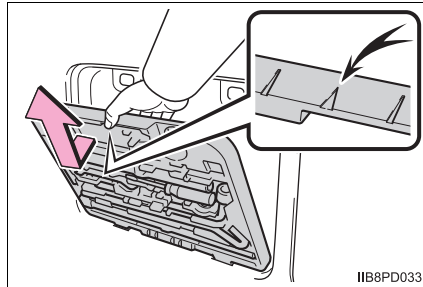

Taking out the spare tire cover (if equipped)

- 1 Remove the bolt cover

- ① Bolt cover

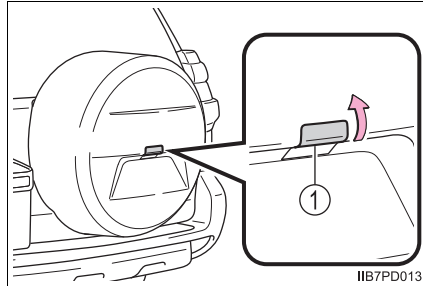

- 2 Remove the bolt which fixes the spare tire cover.

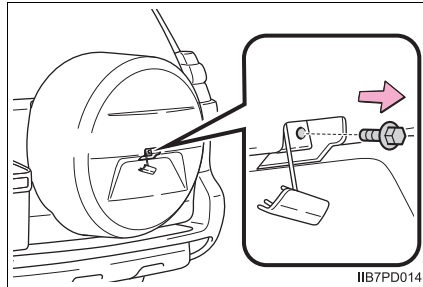

- 3 Unlock the latch and unhook the spare tire cover.

Opening the back door makes unlocking the latch easier.

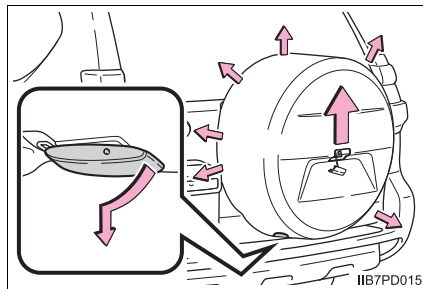

Taking out the spare tire

► Vehicles with back door mounted spare tire

- 1 Unlock the spare tire lock system.

- ① Insert the key into the cylinder.
- ② Remove the key and the cylinder.

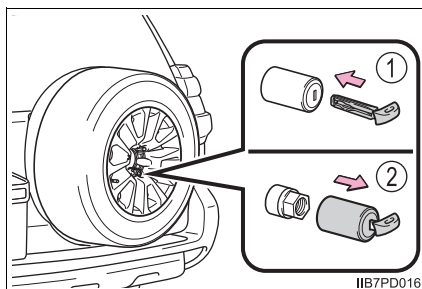

- 2 Turn the hold-down nuts counterclockwise with the wheel nut wrench and remove them.

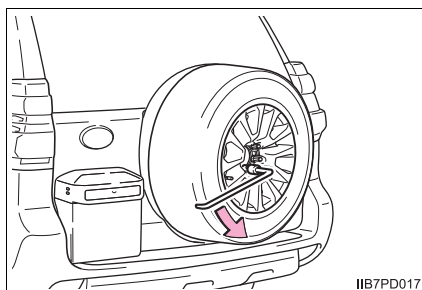

► Vehicles with under floor mounted spare tire

1 Assembling the jack handle.

Remove the jack handle and the jack handle extension bar from the tool box and assemble by following these steps.

- ① Loosen the bolt and the screw using either the jack handle end or a screwdriver.

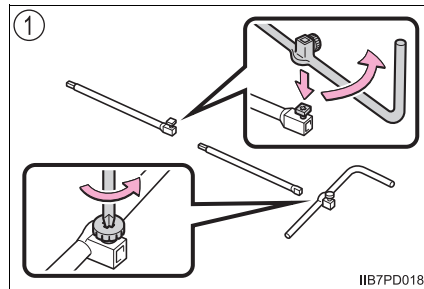

- ② Assemble the jack handle extension bar and the jack handle and tighten the bolt and the screw.

Check that the bolt and screw are firmly tightened.

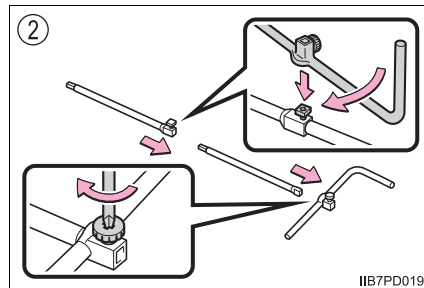

2 Remove the cover.

To protect the bodywork, place a rag between the screwdriver and the vehicle body.

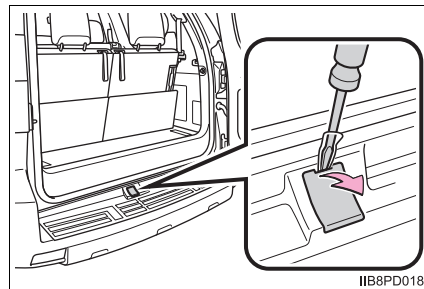

- 3 Insert the jack handle extension into the lowering screw.

- ① Lower
- ② Raise

Place a rag under the jack handle extension to protect the rear bumper.

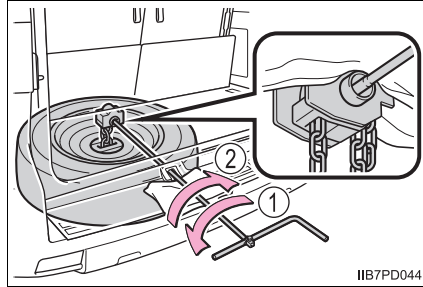

- 4 Lower the spare tire completely to the ground.

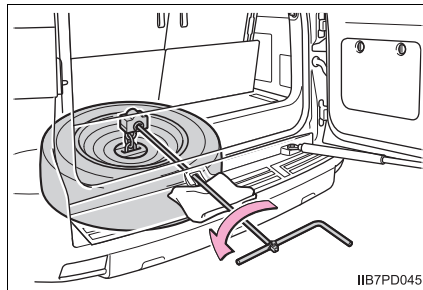

- 5 Pull out the spare tire and remove the holding bracket.

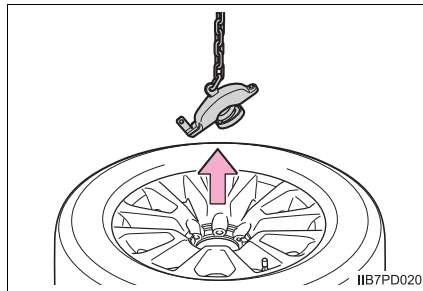

Replacing a flat tire

- 1 Check the tires.

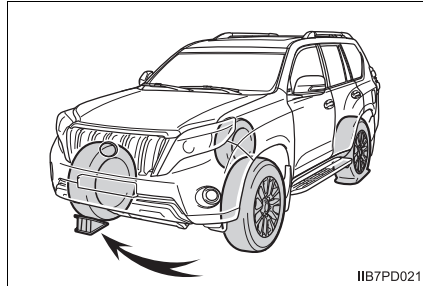

Flat tire		Wheel chock positions
Front	Left-hand side	Behind the rear right-hand side tire
	Right-hand side	Behind the rear left-hand side tire
Rear	Left-hand side	In front of the front right-hand side tire
	Right-hand side	In front of the front left-hand side tire

- 2 Pry off the wheel ornament, using the beveled end of the wheel nut wrench as shown.

To protect the wheel ornament, place a rag between the wheel nut wrench and the wheel ornament.

► Steel wheels

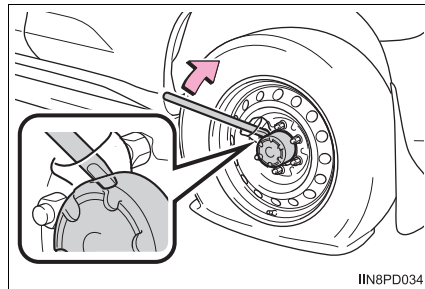

► Aluminum wheels

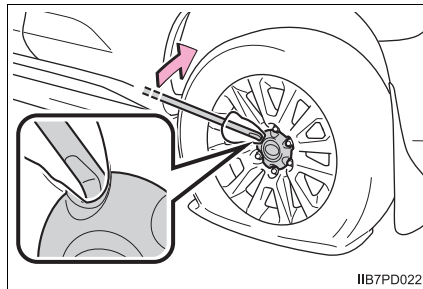

- 3 Slightly loosen the wheel nuts (one turn).

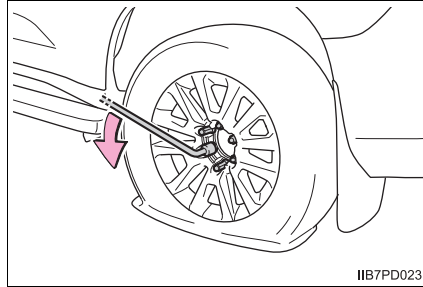

IIB7PD023

- 4 Assembling the jack handle.

Remove the jack handle, jack handle extension bar and jack handle bar from the tool box and assemble by following these steps.

- ① Loosen the bolt and the screw using either the jack handle end or a screwdriver.

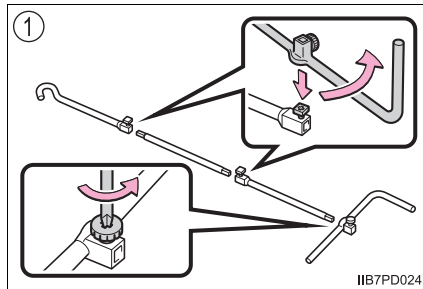

IIB7PD024

- ② Assemble the jack handle extension bar and the jack handle bar and tighten the bolts.

Check that the bolts are firmly tightened.

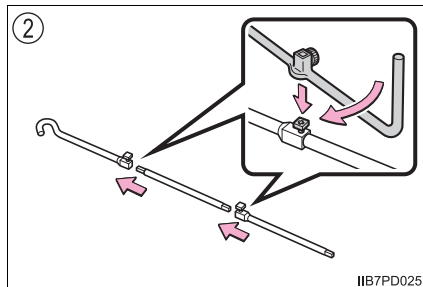

IIB7PD025

- ③ Assemble the jack handle extension bar and the jack handle and tighten the screw.

Check that the screw is firmly tightened.

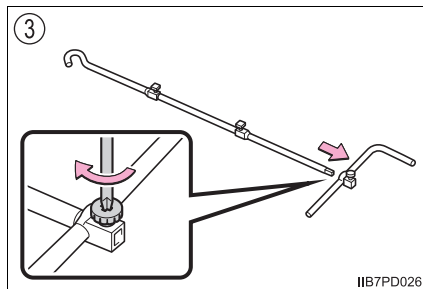

IIB7PD026

- 5 Position the jack at the jack points as shown.

- ① Front
Under the chassis frame side rail
- ② Rear
Under the rear axle housing

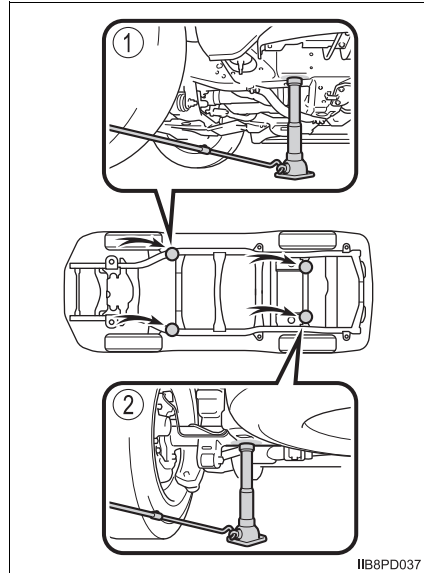

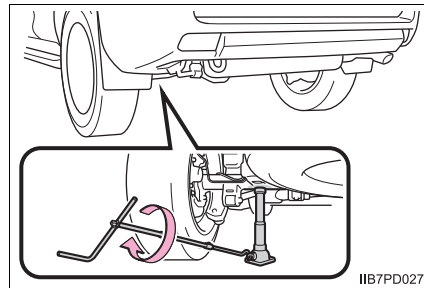

- 6 Raise the vehicle until the tire is slightly raised off the ground.

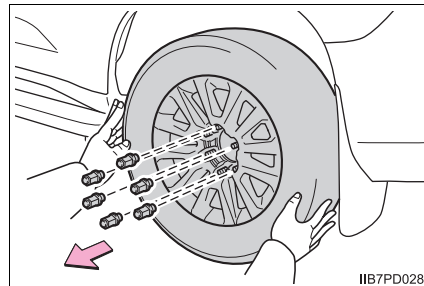

- 7 Remove all the wheel nuts and the tire.

When resting the tire on the ground, place the tire so that the wheel design faces up to avoid scratching the wheel surface.



 CAUTION**■ Replacing a flat tire**

- Observe the following precautions.
Failure to do so may result in serious injury:
 - Vehicles with under floor mounted spare tire: Lower the spare tire completely to the ground before removing it from under the vehicle.
 - Do not try to remove the wheel ornament by hand. Take due care in handling the ornament to avoid unexpected personal injury.
 - Do not touch the disc wheels or the area around the brakes immediately after the vehicle has been driven.
After the vehicle has been driven the disc wheels and the area around the brakes will be extremely hot. Touching these areas with hands, feet or other body parts while changing a tire, etc. may result in burns.
- Failure to follow these precautions could cause the wheel nuts to loosen and the tire to fall off, resulting in death or serious injury.
 - Have the wheel nuts tightened with a torque wrench to 112 N•m (11.4 kgf•m, 83 ft•lbf) as soon as possible after changing wheels.
Failure to follow these precautions could cause the nuts to loosen and the wheel may fall off, which could lead to an accident causing death or serious injury.
 - Do not attach a heavily damaged wheel ornament, as it may fly off the wheel while the vehicle is moving.
 - If there are any cracks or deformations in the bolt screws, nut threads or bolt holes of the wheel, have the vehicle inspected by any authorized Toyota dealer or repairer, or another duly qualified and equipped professional.
 - When installing a tire, only use wheel nuts that have been specifically designed for that wheel.
 - When installing the wheel nuts, be sure to install them with the tapered ends facing inward. (→P. 556)

Installing the spare tire

- 1 Remove any dirt or foreign matter from the wheel contact surface.

If foreign matter is on the wheel contact surface, the wheel nuts may loosen while the vehicle is in motion, and the tire to come off.

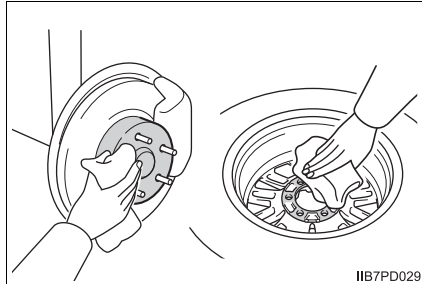

- 2 Install the spare tire and loosely tighten each nut by hand to approximately the same amount.

When replacing a steel wheel with a steel wheel, tighten the wheel nuts until the tapered portion comes into loose contact with the disc wheel seat.

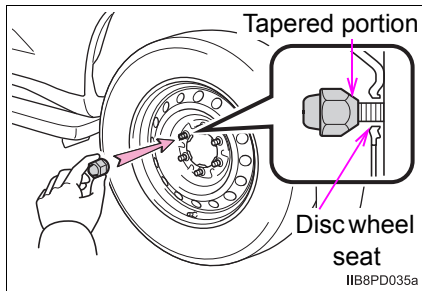

When replacing an aluminum wheel with an aluminum wheel, turn the wheel nuts until the washers come into contact with the disc wheel.

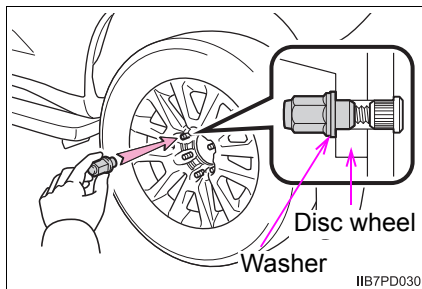

- 3 Lower the vehicle.

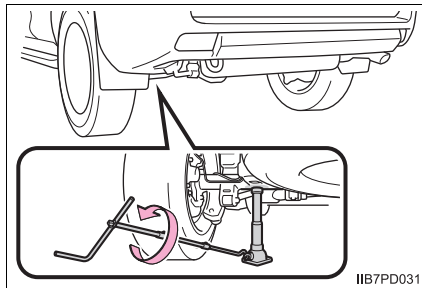

- 4 Firmly tighten each nut two or three times in the order shown in the illustration.

Tightening torque:
112 N•m (11.4 kgf•m, 83 ft•lbf)

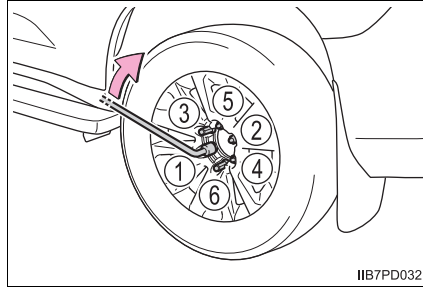

- 5 Reinstall the wheel ornament.

► Steel wheels

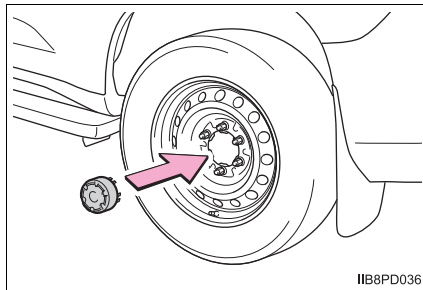

► Aluminum wheels

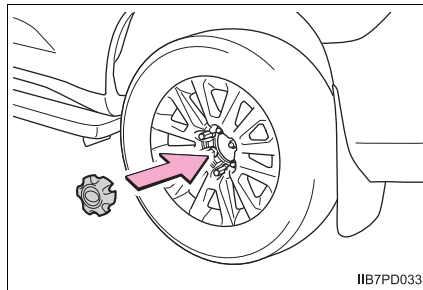

- 6 Stow the flat tire, tools and jack securely, and replace all covers.

Stowing the flat/spare tire, jack and tools

► Vehicles with back door mounted spare tire

- 1 Install the tire and loosely tighten each nut by hand to approximately the same amount.

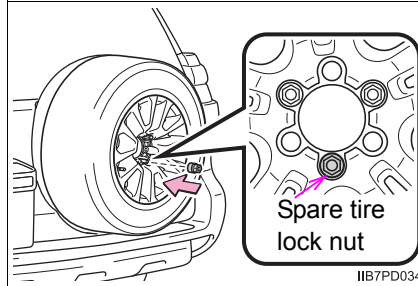

- 2 Firmly tighten each nut two or three times in the order shown in the illustration.

Tightening torque:
60 N•m (6.0 kgf•m, 44 ft•lbf)
Tighten the spare tire lock nut first.

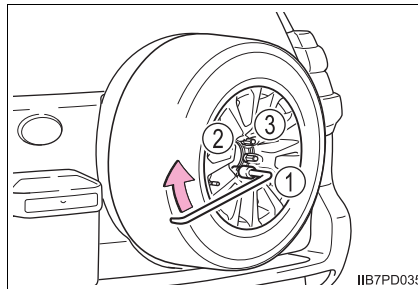

- 3 Lock the spare tire lock system

- 1 Spare tire lock nut.
- 2 Insert the key and cylinder.
- 3 Remove the key while holding the cylinder in place.

Check that the cylinder is locked securely.

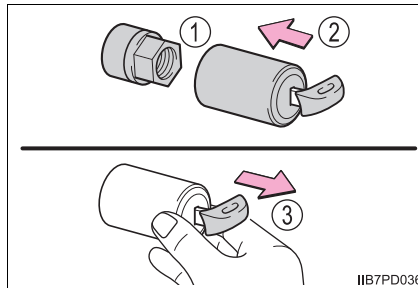

- 4 Vehicles with the spare tire cover: Install the spare tire cover in the reverse order of removal.

Tightening torque:
14 N•m (1.4 kgf•m, 10 ft•lbf)

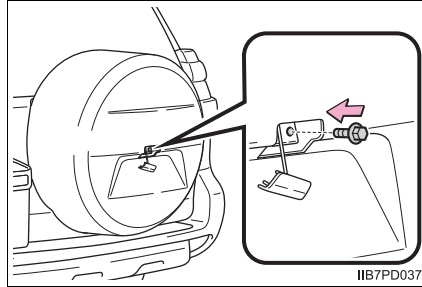

- 5 Stow the tools and jack securely, and replace all covers.

► Vehicles with under floor mounted spare tire

- 1 Lay down the tire with the outer side facing up, and install the holding bracket.

Insert the holding bracket tab into one of the holes in the wheel.

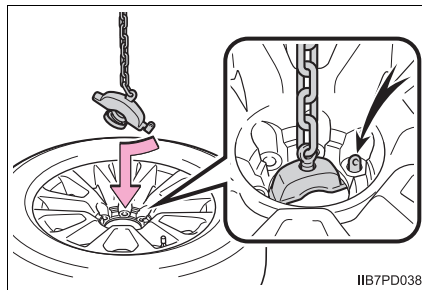

- 2 Raise the tire.

Vehicles with kinetic dynamic suspension: Pull the tire towards the rear of the vehicle when raising. After raising, visually check that the tire is not interfering with suspension components.

- 3 Stow the tools and jack securely, and replace all covers.

■ **Vehicles with spare tire lock system (vehicles with back door mounted spare tire)**

Use the spare tire lock nut only for the spare tire carrier.

 CAUTION

■ **After using the tools and jack**

Before driving, make sure all the tools and jack are securely in place in their storage location to reduce the possibility of personal injury during a collision or sudden braking.

 NOTICE

■ **When stowing the flat tire (vehicles with under floor mounted spare tire)**

Ensure that there is no object caught between the tire and the vehicle underbody.

■ **When assembling the jack handle extension**

Tighten all the joints securely. Otherwise the extension may come off and it may damage the paint or vehicle body.

If you have a flat tire (vehicles without a spare tire)

Your vehicle is equipped with an emergency tire puncture repair kit.

A puncture caused by a nail or screw passing through the tire tread can be repaired temporarily with the emergency tire puncture repair kit.

CAUTION

■ If you have a flat tire

Do not continue driving with a flat tire.

Driving even a short distance with a flat tire can damage the tire and the wheel beyond repair, which could result in an accident.

Driving with a flat tire may cause a circumferential groove on the side wall. In such a case, the tire may explode when using a repair kit.

Before repairing the vehicle

- Stop the vehicle in a safe place on a hard, flat surface.
- Set the parking brake.
- Shift the shift lever to P (automatic transmission) or N (manual transmission).
- Turn off the rear height control air suspension (if equipped).
(→Refer to the “Off-road Driving Owner’s Manual”)
- Stop the engine.
- Turn on the emergency flashers. (→P. 585)

Location of the emergency tire puncture repair kit, jack and tools

► 3-door models

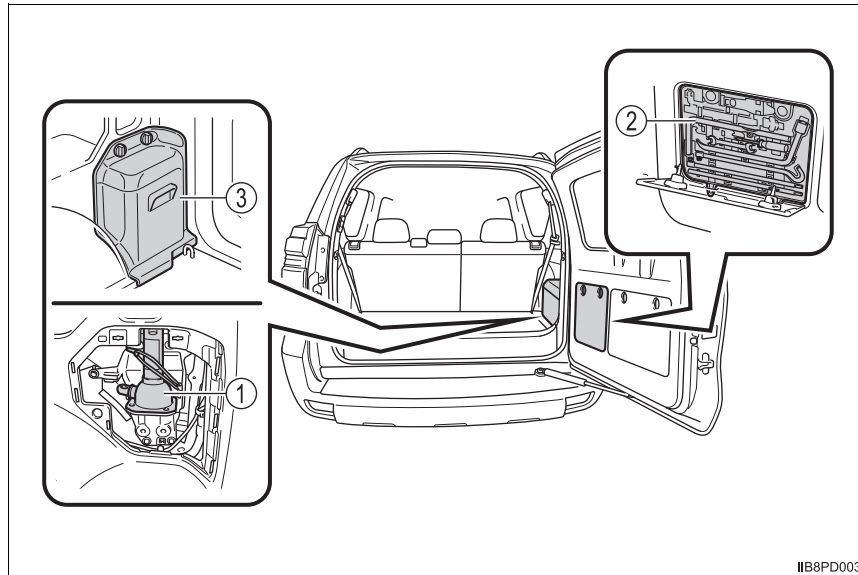

① Jack*1

② Tool box*1, 2

*1: If equipped

*2: Use of the jack (→P. 635)

③ Emergency tire puncture repair kit

▶ 5-door models

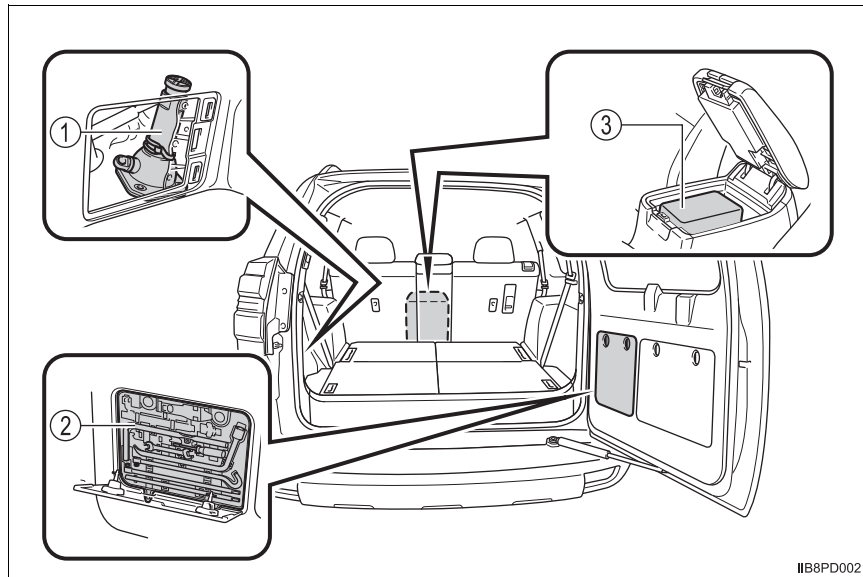

① Jack*1

② Tool box*1, 2

*1: If equipped

*2: Use of the jack (→P. 635)

③ Emergency tire puncture
repair kit

Emergency tire puncture repair kit components

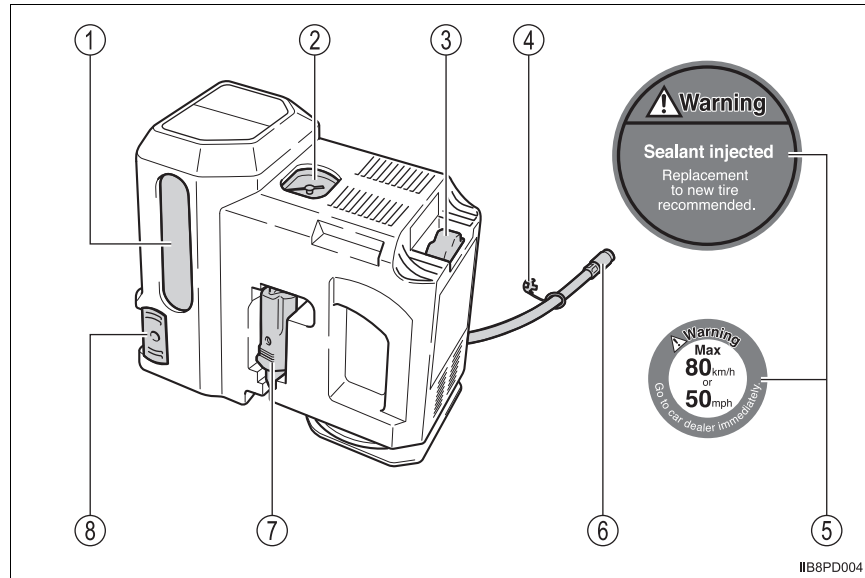

- | | |
|----------------------|-----------------|
| ① Bottle | ⑤ Stickers |
| ② Air pressure gauge | ⑥ Hose |
| ③ Compressor switch | ⑦ Power plug |
| ④ Air release cap | ⑧ Insertion key |

Taking out the emergency tire puncture repair kit

▶ 3-door models

- 1 Remove the cover.

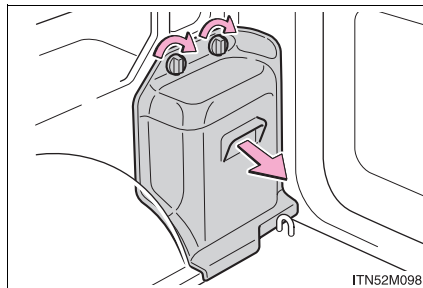

- 2 Take out the emergency tire puncture repair kit.

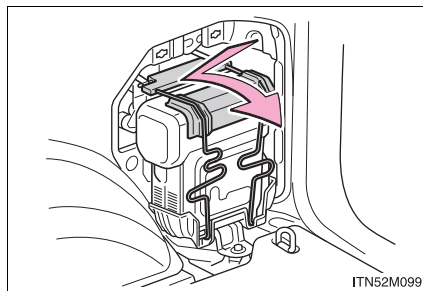

▶ 5-door models

- 1 Open the console box.

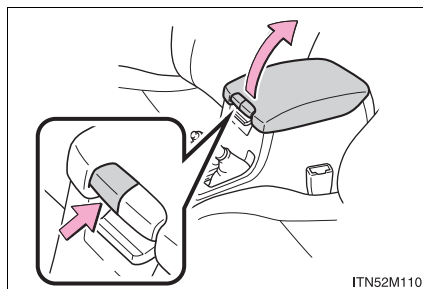

- 2 Take out the emergency tire puncture repair kit.

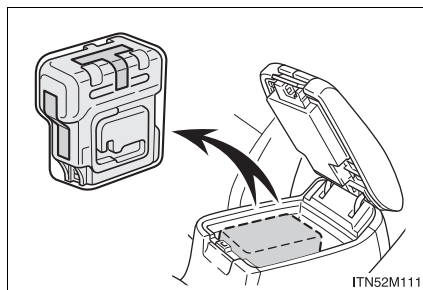

Before performing emergency repair

Check the degree of the tire damage.

A tire should only be repaired with the emergency tire puncture repair kit if the damage is caused by a nail or screw passing through the tire tread.

- Do not remove the nail or screw from the tire. Removing the object may widen the opening and disable emergency repair with the kit.
- To avoid sealant leakage, move the vehicle until the area of the puncture, if known, is positioned at the top of the tire.

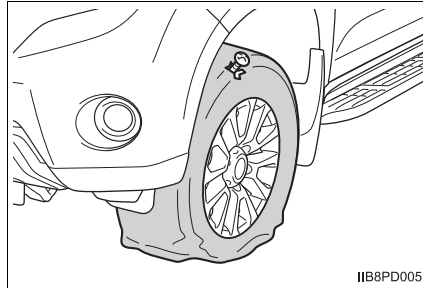

Emergency repair method

- 1 Pull the insertion key out of the kit.

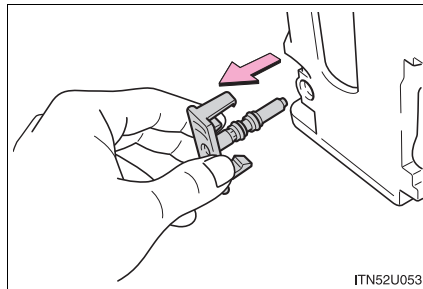

- 2 Place the kit with the bottom facing upward.

Peel off the label, and push in the insertion key until a click is heard.

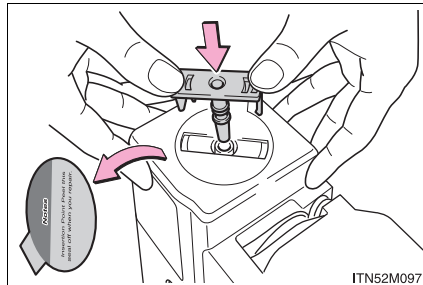

- 3 Return the kit to an upright position and make sure that the compressor switch is off.
Use the kit with the top facing upward.

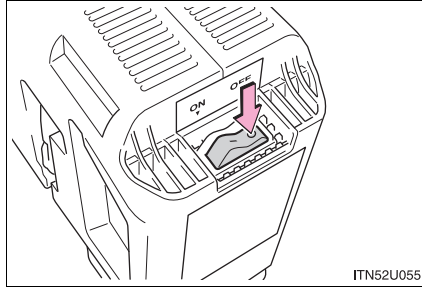

- 4 Connect the power plug to the power outlet socket. (→P. 499)
Open the cover and connect the power plug.

► Front

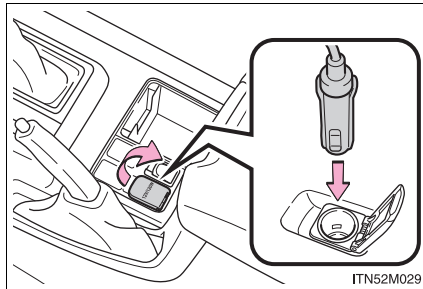

► Rear

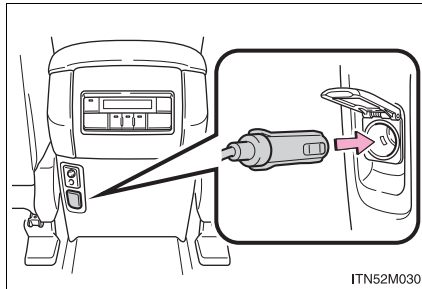

► Luggage compartment
(DC12 V)

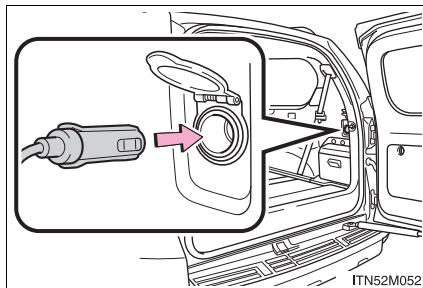

649 8-2. Steps to take in an emergency

- 5 Remove the valve cap from the valve of the punctured tire.

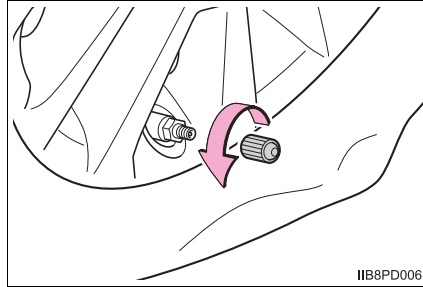

- 6 Remove the air release cap from the hose.

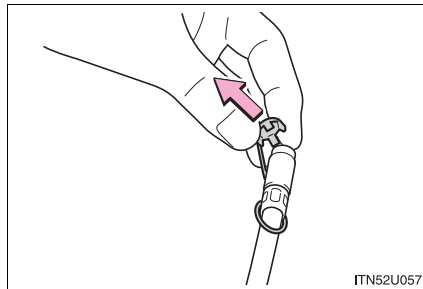

- 7 Connect the hose to the valve. Screw the end of the hose clockwise as far as possible.

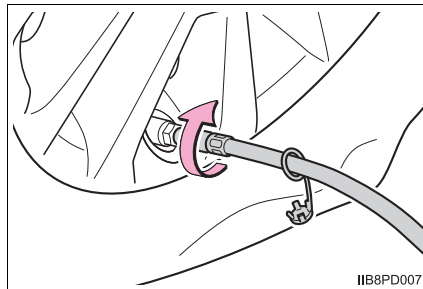

8 Check the specified tire inflation pressure

Tire inflation pressure is specified on the label as shown. (→P. 699)

▶ Left-hand drive vehicles

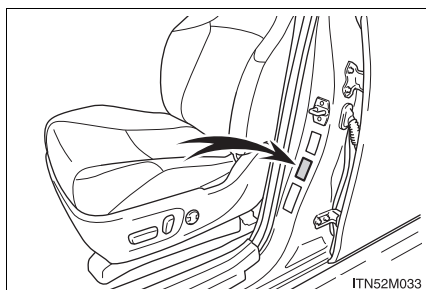

▶ Right-hand drive vehicles

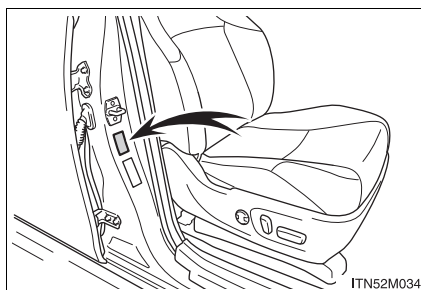
**9** Start the engine. (→P. 244)**10** To inject the sealant and inflate the tire, turn the compressor switch on.

Use the kit with the top facing upward.

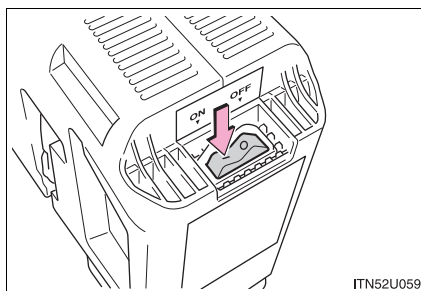

11 Inflate the tire until the recommended pressure is reached.

① The sealant will be injected and the pressure will spike to 300 kPa (3.0 kgf/cm² or bar, 44 psi) or 400 kPa (4.0 kgf/cm² or bar, 58 psi), then gradually decrease.

② The air pressure gauge will display the actual tire inflation pressure about 1 minute after the switch is turned on.

- Turn the compressor switch off and then check the tire inflation pressure. Being careful not to over inflate, check and repeat the inflation procedure until the recommended tire inflation pressure is reached.
- If the needle of the air pressure gauge reaches the red zone (450 kPa [4.5 kgf/cm² or bar, 65 psi] or more), there may be a malfunction in the tire or in the kit itself. Stop operation immediately.
- If the tire inflation pressure is still lower than the recommended level after inflation for 10 minutes with the switch on, the tire is too damaged to be repaired. Turn the compressor switch off and contact any authorized Toyota dealer or repairer, or another duly qualified and equipped professional.
- If the tire inflation pressure exceeds the recommended level, let out some air to adjust the tire inflation pressure. (→P. 655)

12 Disconnect the hose from the valve on the tire and then pull out the power plug from the power outlet socket.

13 To spread the liquid sealant evenly within the tire, immediately drive for about 5 km (3 miles).

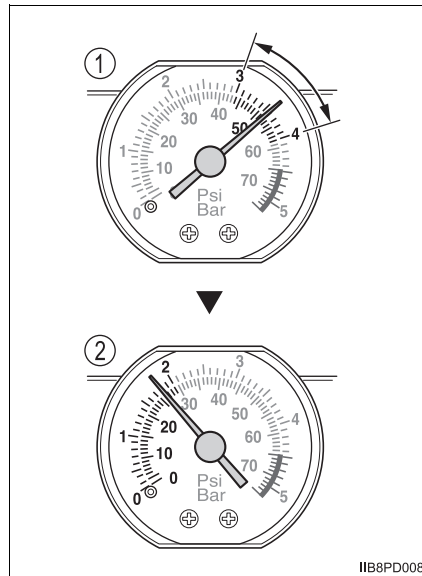

- 14 After driving for about 5 km (3 miles), stop your vehicle in a safe place on a hard, flat surface and reconnect the compressor.

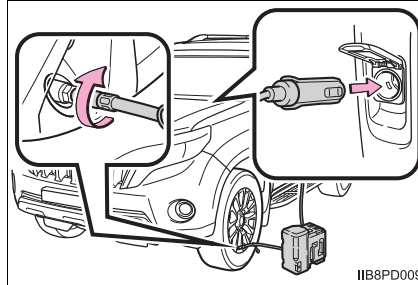

- 15 Turn the compressor switch on and wait for several seconds, then turn it off. Check the tire inflation pressure.

- ① If the tire inflation pressure is below 130 kPa (1.3 kgf/cm² or bar, 19 psi): The puncture cannot be repaired. Contact any authorized Toyota dealer or repairer, or another duly qualified and equipped professional.

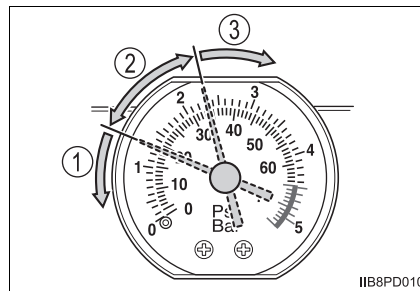

- ② If the tire inflation pressure is between 130 kPa (1.3 kgf/cm² or bar, 19 psi) and a point below the recommended level: The tire can be repaired. Proceed to step 16.

- ③ If the tire inflation pressure is at the recommended level: Proceed to step 17.

- 16 Turn the compressor switch on to inflate the tire until the recommended tire inflation pressure is reached. Drive for about 5 km (3 miles) and then perform step 14.

- 17 Store the kit and then attach the 2 stickers as shown.

Taking precautions to avoid sudden braking and sharp turns, drive carefully at under 80 km/h (50 mph) to the nearest authorized Toyota dealer or repairer, or another duly qualified and equipped professional for tire repair or replacement.

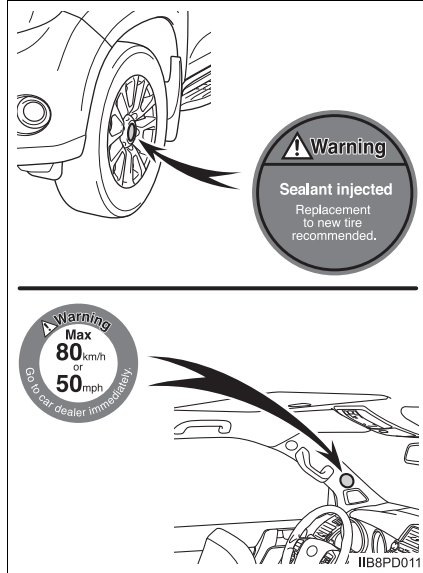

■ **In the following cases, the tire cannot be repaired with the emergency tire puncture repair kit. Contact any authorized Toyota dealer or repairer, or another duly qualified and equipped professional.**

- When the tire is damaged due to driving without sufficient air pressure
- When the tire lost air pressure due to a crack or damage in the tire sidewall
- When the tire is visibly separated from the wheel
- When the cut or damage to the tread is 4 mm (0.16 in.) long or more
- When the wheel is damaged
- When two or more tires have been punctured
- When there is more than one hole or cut in the damaged tire

■ **Emergency tire puncture repair kit**

- The sealant has a limited lifespan. The expiry date is marked on the bottle. The sealant should be replaced before the expiry date. Contact any authorized Toyota dealer or repairer, or another duly qualified and equipped professional for replacement.
- The sealant stored in the emergency tire puncture repair kit can be used only once to temporarily repair a single tire. If the sealant in the bottle and other parts of the kit have been used and need to be purchased, contact any authorized Toyota dealer or repairer, or another duly qualified and equipped professional.
- The sealant can be used when the outside temperature is from -30 °C (-22 °F) to 60 °C (140 °F).
- The kit is exclusively designed for size and type of tires originally installed on your vehicle. Do not use it for tires that a different size than the original ones, or for any other purposes.
- If the sealant gets on your clothes, it may stain.
- If the sealant adheres to a wheel or the surface of the vehicle body, the stain may not be removable if it is not cleaned at once. Immediately wipe away the sealant with a wet cloth.
- During operation of the kit, a loud operation noise is produced. This does not indicate a malfunction.

■ **If the tire is inflated to more than the recommended level**

- 1 Disconnect the hose from the valve.
- 2 Install the air release cap to the end of the hose and push the protrusion on the air release cap into the valve to let some air out.

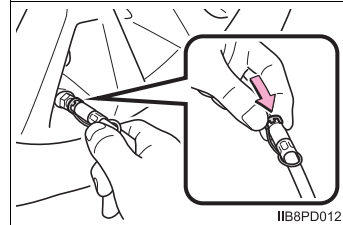

- 3 Disconnect the hose from the valve, remove the air release cap from the hose and then reconnect the hose.
- 4 Turn the compressor switch on and wait for several seconds, then turn it off. Check that the air pressure indicator shows the recommended level. (→P. 699)
If the air pressure is lower than the recommended level, turn the compressor switch on again and repeat the inflation procedure until the recommended pressure is reached.

⚠ CAUTION

■ **Precautions for use of the sealant**

- Ingesting the sealant is hazardous to your health. If you ingest sealant, consume as much water as possible, then immediately consult a doctor.
- If sealant gets in eyes or adheres to skin, immediately wash it off with water. If discomfort persists, consult a doctor.

 CAUTION**■ When fixing the flat tire**

- Stop your vehicle in a safe and flat area.
- Connect the valve and hose securely with the tire installed on the vehicle.
- If the hose is not properly connected to the valve, air leakage may occur or sealant may be sprayed out.
- If the hose comes off the valve while inflating the tire, there is a risk that the hose will move abruptly due to air pressure.
- After inflation of the tire has completed, the sealant may splatter when the hose is disconnected or some air is let out of the tire.
- Keep back from the tire while it is being repaired, as there is a chance of it bursting while the repair operation is being performed. If you notice any cracks or deformation of the tire, turn off the compressor switch and stop the repair operation immediately.
- The kit may overheat if operated for a long period of time. Do not operate the compressor continuously for more than 20 minutes.
- Parts of the kit become hot during operation. Be careful handling the kit during and after operation.
- Do not attach the vehicle speed warning sticker to an area other than the one indicated. If the sticker is attached to an area where an SRS airbag is located, such as the pad of the steering wheel, it may prevent the SRS air bag from operating properly.

■ Driving to spread the liquid sealant evenly

- Drive the vehicle carefully at a low speed. Be especially careful when turning and cornering.
- If the vehicle does not drive straight or you feel a pull through the steering wheel, stop the vehicle and check the following:
 - Tire condition. The tire may have separated from the wheel.
 - Tire inflation pressure. If tire inflation pressure is 130 kPa (1.3 kgf/cm² or bar, 19 psi) or below, this may indicate severe tire damage.

 NOTICE

■ **When performing an emergency repair**

- Perform the emergency repair without removing the nail or screw that has punctured the tread of the tire. If the object that has punctured the tire is removed, repair by the emergency tire puncture repair kit may not be possible.
- The kit is not waterproof. Make sure that the kit is not exposed to water, such as when it is being used in the rain.
- Do not put the kit directly onto dusty ground such as sand at the side of the road. If the kit vacuums up dust etc., a malfunction may occur.
- Use the kit with the top facing upward. The kit cannot work properly if it is laid on its side.

■ **Handling the emergency tire puncture repair kit**

- The compressor power source should be 12 V DC suitable for vehicle use. Do not connect the compressor to any other source.
- If gasoline splatters on the kit, the kit may deteriorate. Take care not to allow gasoline to contact it.
- Store the kit in its assigned place out of reach of children.
- Do not disassemble or modify the kit. Do not subject parts such as the air pressure indicator to impacts. This may cause a malfunction.

■ **To avoid damage to the tire pressure warning valves and transmitters**

When a tire is repaired with liquid sealants, the tire pressure warning valve and transmitter may not operate properly. If a liquid sealant is used, contact any authorized Toyota dealer or repairer, or another duly qualified and equipped professional as soon as possible. Make sure to replace the tire pressure warning valve and transmitter when replacing the tire. (→P. 541)

If the engine will not start

If the engine will not start even though correct starting procedures are being followed (→P. 241, 244), consider each of the following points:

The engine will not start even when the starter motor operates normally.

One of the following may be the cause of the problem:

- There may not be sufficient fuel in the vehicle's tank.
Gasoline engine: Refuel the vehicle.
Diesel engine: →P. 673
- The engine may be flooded. (gasoline engine)
Try to restart the engine again following correct starting procedures.
(→P. 241, 244)
- There may be a malfunction in the engine immobilizer system.
(→P. 83)

The starter motor turns over slowly, the interior lights and headlights are dim, or the horn does not sound or sounds at a low volume.

One of the following may be the cause of the problem:

- The battery may be discharged. (→P. 664)
- The battery terminal connections may be loose or corroded.

The starter motor does not turn over (vehicles with a smart entry & start system).

The engine starting system may be malfunctioning due to an electrical problem such as an open circuit or a blown fuse. However, an interim measure is available to start the engine. (→P. 659)

The starter motor does not turn over, the interior lights and head-lights do not turn on, or the horn does not sound.

One of the following may be the cause of the problem:

- One or both of the battery terminals may be disconnected.
- The battery may be discharged. (→P. 664)
- There may be a malfunction in the steering lock system. (vehicles with a smart entry & start system)

Contact any authorized Toyota dealer or repairer, or another duly qualified and equipped professional if the problem cannot be repaired, or if repair procedures are unknown.

Emergency start function (vehicles with a smart entry & start system)

When the engine does not start, the following steps can be used as an interim measure to start the engine if the engine switch is functioning normally.

- 1 Set the parking brake.
- 2 Put the shift lever in P (automatic transmission) or N (manual transmission).
- 3 Set the engine switch to the ACCESSORY mode.
- 4 Push and hold the engine switch for about 15 seconds while depressing the brake pedal (automatic transmission) or brake and clutch pedals (manual transmission) firmly.

Even if the engine can be started using the above steps, the system may be malfunctioning. Have the vehicle checked by any authorized Toyota dealer or repairer, or another duly qualified and equipped professional.

If the shift lever cannot be shifted from P (automatic transmission)

If the shift lever cannot be shifted with your foot on the brake pedal, there may be a problem with the shift lock system (a system to prevent accidental operation of the shift lever). Have the vehicle inspected by any authorized Toyota dealer or repairer, or another duly qualified and equipped professional immediately. The following steps may be used as an emergency measure to ensure that the shift lever can be shifted:

- 1 Set the parking brake.
- 2 Vehicles without a smart entry & start system:
Turn the engine switch to the "ACC" position.
Vehicles with a smart entry & start system:
Turn the engine switch to ACCESSORY mode.
- 3 Depress the brake pedal.
- 4 Press the shift lock override button.
The shift lever can be shifted while the button is pressed.

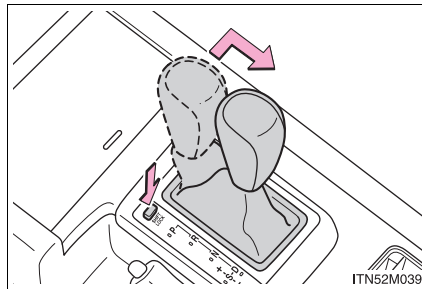

If the electronic key does not operate properly (vehicles with a smart entry & start system)

If communication between the electronic key and vehicle is interrupted (→P. 157) or the electronic key cannot be used because the battery is depleted, the smart entry & start system and wireless remote control cannot be used. In such cases, the doors can be opened and the engine can be started by following the procedure below.

Locking and unlocking the doors and key linked functions

Use the mechanical key (→P. 129) in order to perform the following operations:

- ① Locks all doors
- ② Closes the windows and moon roof* (turn and hold)
- ③ Unlocks all doors
- ④ Opens the windows and moon roof* (turn and hold)

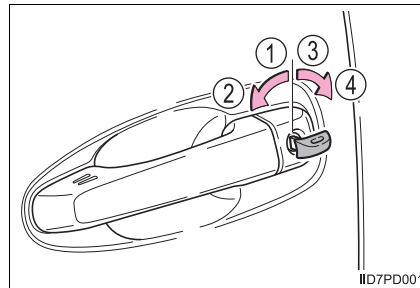

*: These settings must be customized at any authorized Toyota dealer or repairer, or another duly qualified and equipped professional.

Starting the engine

► Automatic transmission

- 1 Ensure that the shift lever is in P and depress the brake pedal.
- 2 Touch the Toyota emblem side of the electronic key to the engine switch.

If any of the doors is opened or closed while the key is being touched to the switch, an alarm will sound to indicate that the start function cannot detect the key.

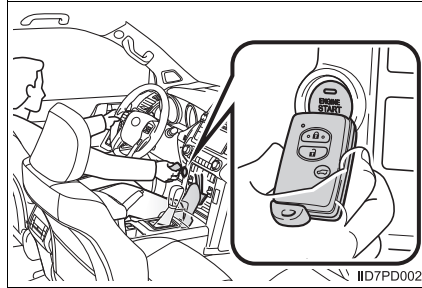

- 3 Press the engine switch within 10 seconds of the buzzer sounding, keeping the brake pedal depressed.

In the event that the engine switch still cannot be operated, contact any authorized Toyota dealer or repairer, or another duly qualified and equipped professional.

► Manual transmission

- 1 Shift the shift lever to N and depress the clutch pedal.
- 2 Touch the Toyota emblem side of the electronic key to the engine switch.

If any of the doors is opened or closed while the key is being touched to the switch, an alarm will sound to indicate that the start function cannot detect the key.

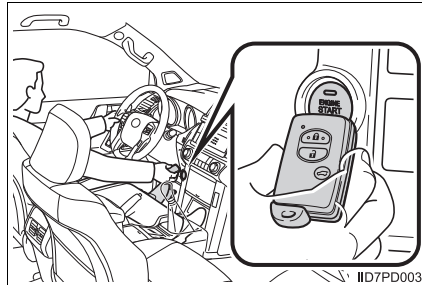

- 3 Press the engine switch within 10 seconds of the buzzer sounding, keeping the clutch pedal depressed.

In the event that the engine switch still cannot be operated, contact any authorized Toyota dealer or repairer, or another duly qualified and equipped professional.

■ **Stopping the engine**

- ▶ Vehicles with an automatic transmission

Shift the shift lever to P and press the engine switch as you normally do when stopping the engine.

- ▶ Vehicles with a manual transmission

Shift the shift lever to N and press the engine switch as you normally do when stopping the engine.

■ **Replacing the key battery**

As the above procedure is a temporary measure, it is recommended that the electronic key battery be replaced immediately when the battery is depleted. (→P. 560)

■ **Alarm (if equipped)**

Using the mechanical key to lock the doors will not set the alarm system.

If a door is unlocked using the mechanical key when the alarm system is set, the alarm may be triggered. (→P. 92)

■ **Changing engine switch modes**

- ▶ Vehicles with an automatic transmission

Within 10 seconds of the buzzer sounding, release the brake pedal and press the engine switch.

The engine does not start and modes will be changed each time the switch is pressed. (→P. 247)

- ▶ Vehicles with a manual transmission

Within 10 seconds of the buzzer sounding, release the clutch pedal and press the engine switch.

The engine does not start and modes will be changed each time the switch is pressed. (→P. 247)

■ **When the electronic key does not work properly**

Make sure that the smart entry & start system has not been deactivated in the customization setting. If it is off, turn the function on.

(Customizable features: →P. 705)

If the vehicle battery is discharged

The following procedures may be used to start the engine if the vehicle's battery is discharged.

You can call any authorized Toyota dealer or repairer, or another duly qualified and equipped professional.

If you have a set of jumper (or booster) cables and a second vehicle with a 12-volt battery, you can jump start your Toyota following the steps below.

- 1 Open the hood. (→P. 520)
- 2 Remove the engine cover.
 - ▶ Vehicles with 1GR-FE engine

Lift the edge of the cover to disengage the fixed pins, and then pull the cover towards you to remove it.

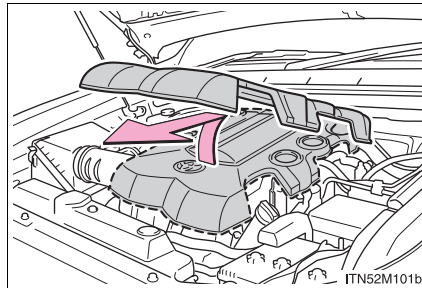

► Vehicles with 1KD-FTV engine*¹

- ① Remove the bolts.

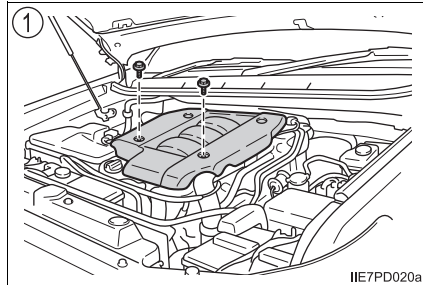

- ② Raise the front of the engine cover and then pull the cover to detach it from the bracket on the rear bar as shown in the illustration.

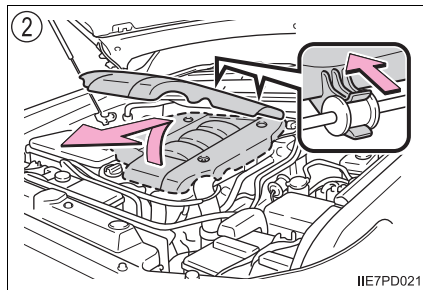

- ③ Connect the jumper cables according to the following procedures:
 - ① Positive (+) battery terminal on your vehicle
 - ② Positive (+) battery terminal on the second vehicle
 - ③ Negative (-) battery terminal on the second vehicle
 - ④ Connect the jumper cable to ground on your vehicle as shown in the illustration.

► 2TR-FE engine

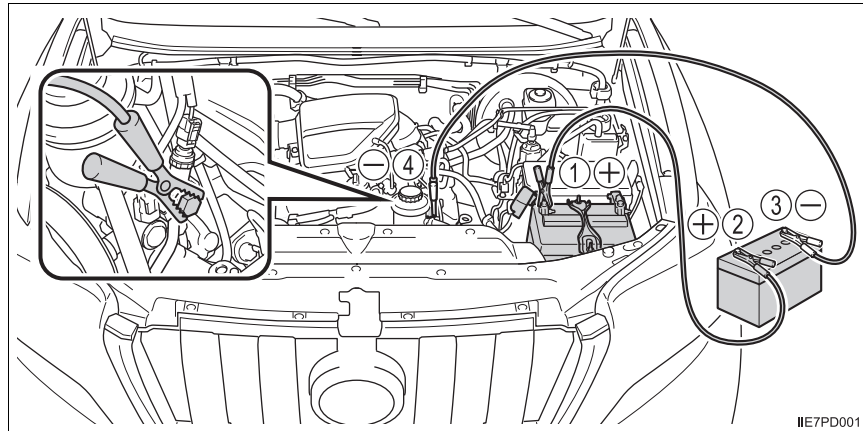

► 1GR-FE engine

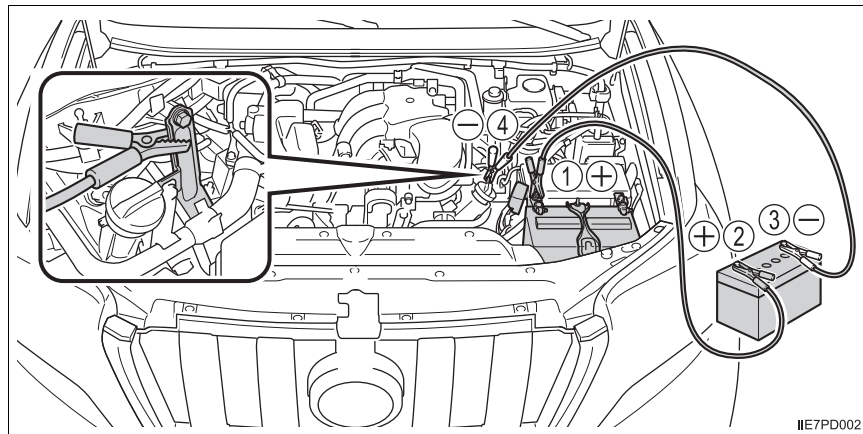

► 1KD-FTV engine

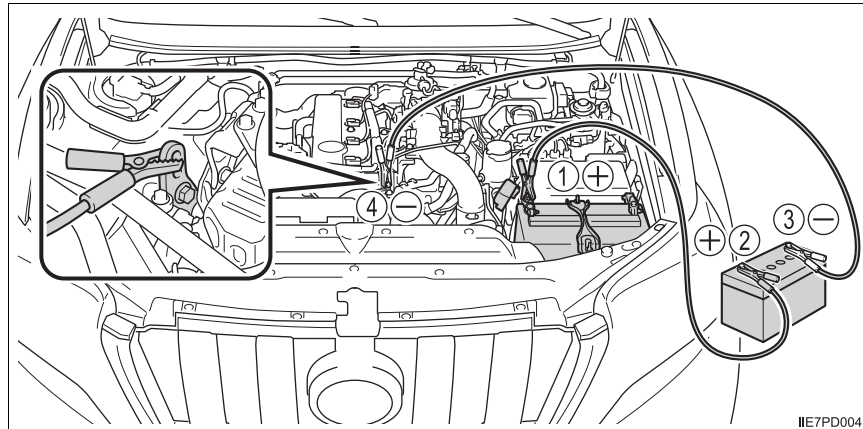

- 4 Start the engine of the second vehicle. Increase the engine speed slightly and maintain at that level for approximately 5 minutes to recharge the battery of your vehicle.
- 5 Vehicles with a smart entry & start system: Open and close any of the doors with the engine switch off.
- 6 Maintain the engine speed of the second vehicle and start the engine of your vehicle by turning the engine switch to IGNITION ON mode (vehicles with a smart entry & start system) or turning the engine switch to the "ON" position (vehicles without a smart entry & start system).
- 7 Once the vehicle's engine has started, remove the jumper cables in the exact reverse order in which they were connected.
- 8 Vehicles with 1GR-FE and 1KD FTV engines*1: To install the engine cover, conduct the removal procedure in reverse. After installing, check that the fixed pins are inserted securely.

Once the engine starts, have the vehicle checked at any authorized Toyota dealer or repairer, or another duly qualified and equipped professional, as soon as possible.

*1: Vehicles with DPF system*2

*2: To determine whether or not your vehicle has a DPF system, contact any authorized Toyota dealer or repairer, or another duly qualified and equipped professional.

■ Starting the engine when the battery is discharged (vehicles with an automatic transmission)

The engine cannot be started by push-starting.

■ To prevent battery discharge

- Turn off the headlights and the audio system while the engine is off.
- Turn off any unnecessary electrical components when the vehicle is running at a low speed for an extended period, such as in heavy traffic.

■ Charging the battery

The electricity stored in the battery will discharge gradually even when the vehicle is not in use, due to natural discharge and the draining effects of certain electrical appliances. If the vehicle is left for a long time, the battery may discharge, and the engine may be unable to start. (The battery recharges automatically during driving.)

■ When recharging or replacing the battery (vehicles with a smart entry & start system)

- Make sure that the key is not inside the vehicle when recharging or replacing the battery. The key may be locked in the vehicle if the alarm is activated. (→P. 93)
- In some cases, it may not be possible to unlock the doors using the smart entry & start system when the battery is discharged. Use the wireless remote control or the mechanical key to lock or unlock the doors.
- The engine may not start on the first attempt after the battery has recharged but will start normally after the second attempt. This is not a malfunction.
- The engine switch mode is memorized by the vehicle. When the battery is reconnected, the system will return to the mode it was in before the battery was discharged. Before disconnecting the battery, turn the engine switch off. If you are unsure what mode the engine switch was in before the battery discharged, be especially careful when reconnecting the battery.

 CAUTION**■ Avoiding battery fires or explosions**

Observe the following precautions to prevent accidentally igniting the flammable gas that may be emitted from the battery:

- Make sure the jumper cable is connected to the correct terminal and that it is not unintentionally in contact with any other than the intended terminal.
- Do not allow the + and - clamps of the jumper cables to come into contact with each other.
- Do not smoke, use matches, cigarette lighters or allow open flame near the battery.

■ Battery precautions

The battery contains poisonous and corrosive acidic electrolyte, while related parts contain lead and lead compounds. Observe the following precautions when handling the battery:

- When working with the battery, always wear safety glasses and take care not to allow any battery fluids (acid) to come into contact with skin, clothing or the vehicle body.
- Do not lean over the battery.
- In the event that battery fluid comes into contact with the skin or eyes, immediately wash the affected area with water and seek medical attention. Place a wet sponge or cloth over the affected area until medical attention can be received.
- Always wash your hands after handling the battery support, terminals, and other battery-related parts.
- Do not allow children near the battery.

■ To prevent damaging the vehicle (vehicles with a manual transmission)

Do not pull- or push-start the vehicle, because the catalytic converter may overheat and become a fire hazard.

 NOTICE**■ When handling jumper cables**

When connecting the jumper cables, ensure that they do not become entangled in the cooling fans or belt.

■ To prevent damage to the engine cover

- When removing the cover, make sure that you pull the cover towards you after lifting the front edge to remove the fixed pins.
- When installing the cover, do not force the cover or subject it to strong shocks.

If your vehicle overheats

The following may indicate that your vehicle is overheating.

- The needle of the engine coolant temperature gauge (→P. 106) enters the red zone or a loss of engine power is experienced. (For example, the vehicle speed does not increase.)
- Steam is coming from under the hood.

Correction procedures

- 1 Stop the vehicle in a safe place and turn off the air conditioning system, and then stop the engine.
- 2 If you see steam:
Carefully lift the hood after the steam subsides.
If you do not see steam:
Carefully lift the hood.
- 3 After the engine has cooled down sufficiently, inspect the hoses and radiator core (radiator) for any leaks.

① Radiator

② Cooling fans

If a large amount of coolant leaks, immediately contact any authorized Toyota dealer or repairer, or another duly qualified and equipped professional.

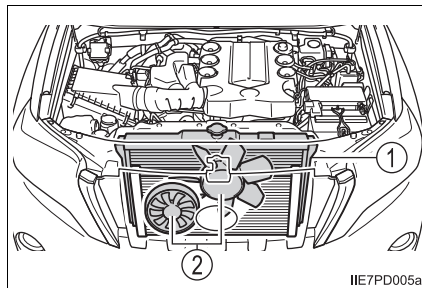

- 4 The coolant level is satisfactory if it is between the “FULL” and “LOW”/“F” and “L” lines on the reservoir.

- ① Reservoir
- ② “FULL” or “F”
- ③ “LOW” or “L”
- ④ Radiator cap (if equipped)

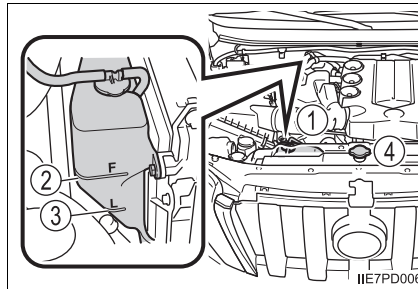

- 5 Add coolant if necessary. (→P. 524)

Water can be used in an emergency if coolant is unavailable.

▶ Gasoline engine

▶ Diesel engine

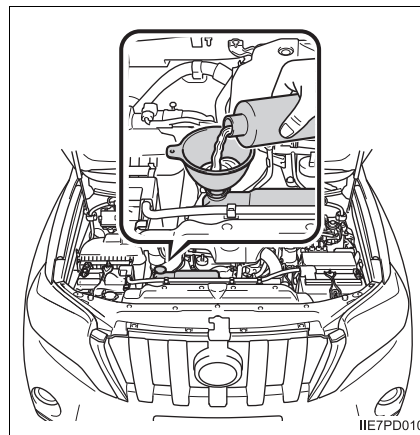

- 6 Start the engine and turn the air conditioning system on to check that the radiator cooling fans operate and to check for coolant leaks from the radiator or hoses.

The fans operate when the air conditioning system is turned on immediately after a cold start. Confirm that the fans are operating by checking the fan sound and air flow. If it is difficult to check these, turn the air conditioning system on and off repeatedly. (The fans may not operate in freezing temperatures.)

7 If the fans are not operating:

Stop the engine immediately and contact any authorized Toyota dealer or repairer, or another duly qualified and equipped professional.

If the fans are operating:

Have the vehicle inspected at the nearest authorized Toyota dealer or repairer, or another duly qualified and equipped professional.

 **CAUTION****■ When inspecting under the hood of your vehicle**

Observe the following precautions.

Failure to do so may result in serious injury such as burns.

- If steam is seen coming from under the hood, do not open the hood until the steam has subsided. The engine compartment may be very hot.
- Keep hands and clothing (especially a tie, a scarf or a muffler) away from the fans and belts. Failure to do so may cause the hands or clothing to be caught, resulting in serious injury.
- Do not loosen the radiator cap or the coolant reservoir cap while the engine and radiator are hot. High temperature steam or coolant could spray out.

 **NOTICE****■ When adding engine coolant**

Add coolant slowly after the engine has cooled down sufficiently. Adding cool coolant to a hot engine too quickly can cause damage to the engine.

■ To prevent damage to the cooling system

Observe the following precautions:

- Avoid contaminating the coolant with foreign matter (such as sand or dust etc.).
- Do not use any coolant additives.

If you run out of fuel and the engine stalls (diesel engine only)

If you run out of fuel and the engine stalls:

- 1 Refuel your vehicle.
- 2 To bleed the fuel system, operate the priming pump until you feel more resistance.

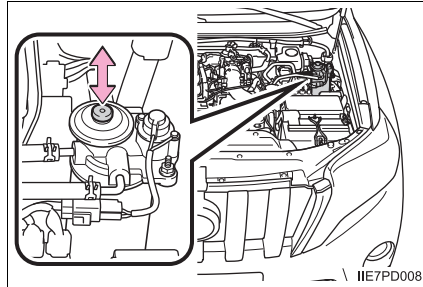

- 3 Start the engine. (→P. 244)

If the engine does not start after the above steps have been performed, wait for 10 seconds and try step 2 and 3 again. If the engine still does not start, contact any authorized Toyota dealer or repairer, or another duly qualified and equipped professional.

After starting the engine, depress the accelerator pedal lightly until the engine runs smoothly.

NOTICE

■ When restarting the engine

- Do not crank the engine before refueling and operating the priming pump. This may damage the engine and fuel system.
- Do not crank the engine for more than 30 seconds at a time. This may overheat the starter and wiring system.

If the vehicle becomes stuck

Carry out the following procedures if the tires spin or the vehicle becomes stuck in mud, dirt, or snow:

- 1 Stop the engine. Set the parking brake and put the shift lever in P (automatic transmission) or N (manual transmission).
- 2 Remove the mud, snow, or sand from around the stuck tire.
- 3 Place wood, stones or some other material to help provide traction under the tires.
- 4 Restart the engine.
- 5 Shift the shift lever to D or R (automatic transmission) or 1 or R (manual transmission) and release the parking brake. Then, while exercising caution, depress the accelerator pedal.

■ When it is difficult to free the vehicle

Turn off TRC and/or VSC if these functions are hampering your attempts to free the vehicle. (→P. 363)

Press  to turn off TRC.

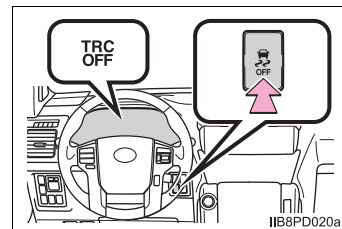

 CAUTION**■ When attempting to free a stuck vehicle**

If you choose to push the vehicle back and forth to free it, make sure the surrounding area is clear, to avoid striking other vehicles, objects or people. The vehicle may also lunge forward or lunge back suddenly as it becomes free. Use extreme caution.

■ When shifting the shift lever

For vehicles with an automatic transmission, be careful not to shift the shift lever with the accelerator pedal depressed. This may lead to unexpected rapid acceleration of the vehicle that may cause an accident and result in death or serious injury.

 NOTICE**■ To avoid damaging the transmission and other components**

- Avoid spinning the wheels and depressing the accelerator pedal more than necessary.
- If the vehicle remains stuck even after these procedures are performed, the vehicle may require towing to be freed.

Vehicle specifications

9

9-1. Specifications

Maintenance data
(fuel, oil level, etc.).....676
Fuel information702

9-2. Customization

Customizable features705

9-3. Items to initialize

Items to initialize715

Maintenance data (fuel, oil level, etc.)

Dimensions and weights

Overall length	5-door models	4780 mm (188.2 in.) ^{*1} 4950 mm (194.9 in.) ^{*2}
	3-door models	4335 mm (170.7 in.) ^{*1} 4505 mm (177.4 in.) ^{*2}
Overall width		1885 mm (74.2 in.)
Overall height ^{*3}	5-door models	1835 mm (72.2 in.) ^{*4, 6} 1845 mm (72.6 in.) ^{*5, 6} 1880 mm (74.0 in.) ^{*4, 7} 1890 mm (74.4 in.) ^{*5, 7}
	3-door models	1830 mm (72.0 in.) ^{*6} 1875 mm (73.8 in.) ^{*7}
Wheelbase	5-door models	2790 mm (109.8 in.)
	3-door models	2450 mm (96.5 in.)
Front and rear tread		1605 mm (63.2 in.) ^{*8} 1585 mm (62.4 in.) ^{*9}

Gross vehicle mass	1GR-FE engine		Except for 2-seat models 2900 kg (6393 lb.) 2-seat models 2830 kg (6239 lb.)
	2TR-FE engine		2850 kg (6283 lb.)
	1KD-FTV engine	5-door models	2990 kg (6592 lb.) ^{*10} 2980 kg (6571 lb.) ^{*11} 2890 kg (6371 lb.) ^{*12}
		3-door models	2600 kg (5732 lb.)
Maximum permissible axle capacity	Front	1450 kg (3197 lb.)	
	Rear	1800 kg (3968 lb.)	
Drawbar load		120 kg (265 lb.) ^{*13} 60 kg (132 lb.) ^{*14}	
Towing capacity	With brake	3000 kg (6614 lb.) ^{*13} 1500 kg (3307 lb.) ^{*14}	
	Without brake	750 kg (1653 lb.)	

- *1: Vehicles without back door mounted spare tire
- *2: Vehicles with back door mounted spare tire
- *3: Unladen vehicles
- *4: Vehicles with rear height control air suspension
- *5: Vehicles without rear height control air suspension
- *6: Vehicles without roof rail
- *7: Vehicles with roof rail
- *8: P265/65R17, 265/65R17, P265/60R18 or 265/60R18 tires
- *9: P245/70R17 or 245/70R17 tires
- *10: Vehicle category M1^{*16}
- *11: Vehicle category N1^{*16} with 5-seat models
- *12: Vehicle category N1^{*16} with 2-seat models
- *13: 1GR-FE engine with model code^{*15} that has "W" as the last letter and 1KD-FTV engine.
- *14: Except for 1GR-FE engine with model code^{*15} that has "W" as the last letter and 1KD-FTV engine.
- *15: The model code is indicated on the manufacturer's label. (→P. 680)
- *16: To distinguish the vehicle category, ask any authorized Toyota dealer or repairer, or another duly qualified and equipped professional.

Vehicle identification

■ Vehicle identification number

The vehicle identification number (VIN) is the legal identifier for your vehicle. This is the primary identification number for your Toyota. It is used in registering the ownership of your vehicle.

This number is stamped on the front right frame.

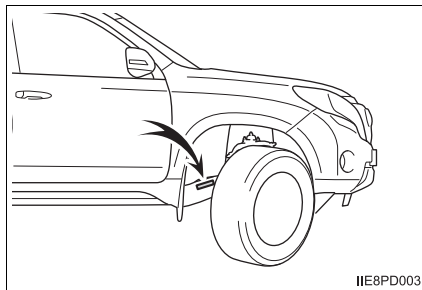

On some models, this number is also stamped on the top left of the instrument panel.

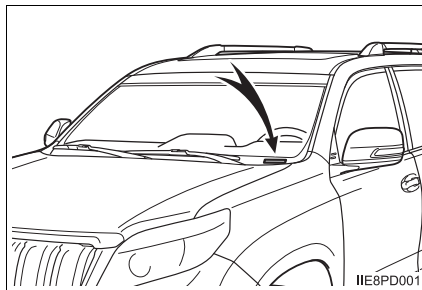

This number is also on the manufacturer's label on the left-hand side center pillar.

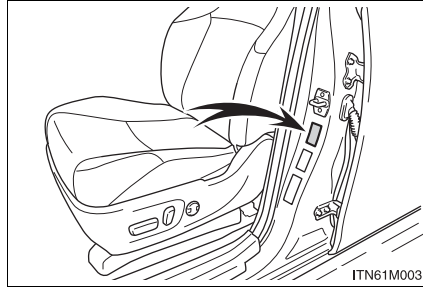

■ **Engine number**

The engine number is stamped on the engine block as shown.

▶ **1GR-FE engine**

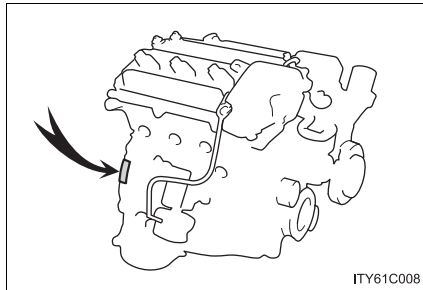

▶ **2TR-FE engine**

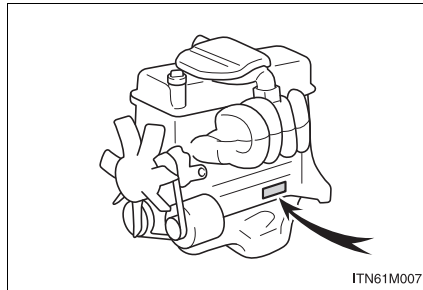

▶ **1KD-FTV engine**

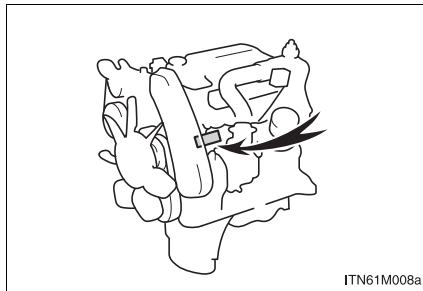

Engine

► Gasoline engine

Model	1GR-FE	2TR-FE
Type	6-cylinder V type, 4-cycle, gasoline	4-cylinder in line, 4-cycle, gasoline
Bore and stroke	94.0 × 95.0 mm (3.70 × 3.74 in.)	95.0 × 95.0 mm (3.74 × 3.74 in.)
Displacement	3956 cm ³ (241.4 cu.in.)	2694 cm ³ (164.4 cu.in.)
Valve clearance	Automatic adjustment	
Drive belt tension		

► Diesel engine

Model	1KD-FTV
Type	4-cylinder in line, 4-cycle, diesel (with turbocharger)
Bore and stroke	96.0 × 103.0 mm (3.78 × 4.06 in.)
Displacement	2982 cm ³ (182.0 cu.in.)
Valve clearance (engine cold)	Intake: 0.20 — 0.30 mm (0.008 — 0.012 in.) Exhaust: 0.35 — 0.45 mm (0.014 — 0.018 in.)
Drive belt tension	Automatic adjustment

Fuel

► Gasoline engine

Fuel type		EU area: Unleaded gasoline conforming to European standard EN228 only Except EU area: Unleaded gasoline only
Research octane number		1GR-FE engine: 95 or higher 2TR-FE engine: 91 or higher
Fuel tank capacity (Reference)	Vehicles with sub fuel tank system	150 L (39.6 gal., 33.0 Imp.gal.)
	Vehicles without sub fuel tank system	87 L (23.0 gal., 19.1 Imp.gal.)

► Diesel engine

Fuel type		EU area: Diesel fuel conforming to European standard EN590 Except EU area: Diesel fuel that contains 50 ppm or less of sulfur
Cetane number		48 or higher
Fuel tank capacity (Reference)	Vehicles with sub fuel tank system	150 L (39.6 gal., 33.0 Imp.gal.)
	Vehicles without sub fuel tank system	87 L (23.0 gal., 19.1 Imp.gal.)

Lubrication system

▶ 1GR-FE engine

Oil capacity (Drain and refill — reference*1)	
With filter	6.2 L (6.6 qt., 5.5 Imp.qt.)
Without filter	5.7 L (6.0 qt., 5.0 Imp.qt.)

*1: The engine oil capacity is a reference quantity to be used when changing the engine oil. Warm up and turn off the engine, wait more than 5 minutes, and check the oil level on the dipstick.

■ **Engine oil selection (GRJ150L-GKAEKW models*2)**

*2: The model code is indicated on the manufacturer's label. (→P. 680)

“Toyota Genuine Motor Oil” is used in your Toyota vehicle. Toyota recommends the use of approved “Toyota Genuine Motor Oil”. Another motor oil of matching quality can also be used.

Oil grade:

0W-20, 5W-20, 5W-30 and 10W-30:

API grade SL “Energy-Conserving”, SM “Energy-Conserving” or SN “Resource-Conserving”; or ILSAC multigrade engine oil

15W-40 and 20W-50:

API grade SL, SM or SN multigrade engine oil

Recommended viscosity (SAE):

SAE 0W-20 is filled into your Toyota vehicle at manufacturing, and the best choice for good fuel economy and good starting in cold weather.

If SAE 0W-20 oil is not available, SAE 5W-30 oil may be used. However, it should be replaced with SAE 0W-20 at the next oil change.

If you use SAE 10W-30 or a higher viscosity engine oil in extremely low temperatures, the engine may become difficult to start, so SAE 0W-20, 5W-20 or 5W-30 engine oil is recommended.

Oil viscosity (0W-20 is explained here as an example):

- The 0W in 0W-20 indicates the characteristic of the oil which allows cold startability. Oils with a lower value before the W allow for easier starting of the engine in cold weather.
- The 20 in 0W-20 indicates the viscosity characteristic of the oil when the oil is at high temperature. An oil with a higher viscosity (one with a higher value) may be better suited if the vehicle is operated at high speeds, or under extreme load conditions.

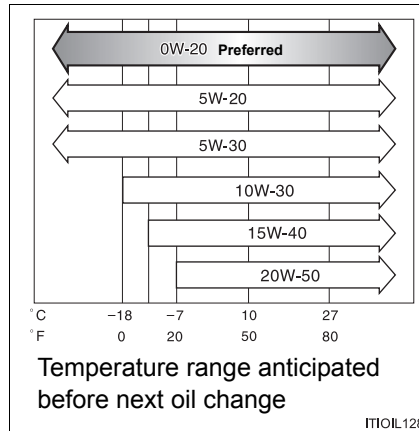

How to read oil container labels:

Either or both API registered marks are added to some oil containers to help you select the oil you should use.

① API Service Symbol

Top portion: "API SERVICE SN" means the oil quality designation by American Petroleum Institute (API).

Center portion: "SAE 0W-20" means the SAE viscosity grade.

Lower portion: "Resource-Conserving" means that the oil has fuel-saving and environmental protection capabilities.

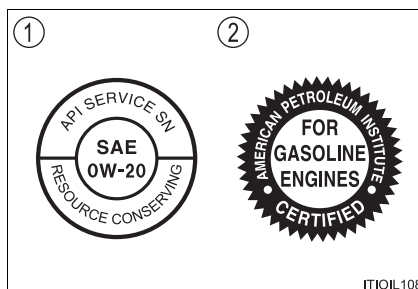

② ILSAC Certification Mark

The International Lubricant Specification Advisory Committee (ILSAC) Certification Mark is displayed on the front of the container.

■ **Engine oil selection (GRJ150L-GKAEK models*3)**

*3: The model code is indicated on the manufacturer's label. (→P. 680)

"Toyota Genuine Motor Oil" is used in your Toyota vehicle. Use Toyota approved "Toyota Genuine Motor Oil" or equivalent to satisfy the following grade and viscosity.

Oil grade:

5W-30 and 10W-30:

API grade SL "Energy-Conserving", SM "Energy-Conserving" or SN "Resource-Conserving"; or ILSAC multigrade engine oil

15W-40 and 20W-50:

API grade SL, SM or SN multigrade engine oil

Recommended viscosity (SAE):

If you use SAE 10W-30 or a higher viscosity engine oil in extremely low temperatures, the engine may become difficult to start, so SAE 5W-30 engine oil is recommended.

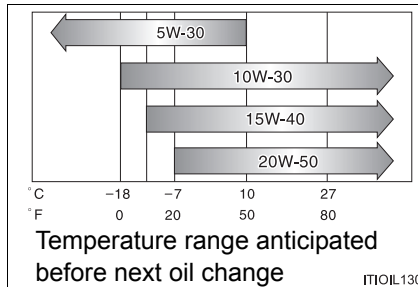

Oil viscosity (10W-30 is explained here as an example):

- The 10W in 10W-30 indicates the characteristic of the oil which allows cold startability. Oils with a lower value before the W allow for easier starting of the engine in cold weather.
- The 30 in 10W-30 indicates the viscosity characteristic of the oil when the oil is at high temperature. An oil with a higher viscosity (one with a higher value) may be better suited if the vehicle is operated at high speeds, or under extreme load conditions.

How to read oil container labels:

Either or both API registered marks are added to some oil containers to help you select the oil you should use.

① API Service Symbol

Top portion: “API SERVICE SN” means the oil quality designation by American Petroleum Institute (API).

Center portion: “SAE 10W-30” means the SAE viscosity grade.

Lower portion: “Resource-Conserving” means that the oil has fuel-saving and environmental protection capabilities.

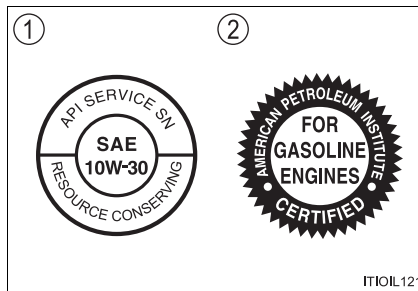

② ILSAC Certification Mark

The International Lubricant Specification Advisory Committee (ILSAC) Certification Mark is displayed on the front of the container.

► 2TR-FE engine

Oil capacity (Drain and refill — reference*)	
With filter	5.7 L (6.0 qt., 5.0 Imp.qt.)
Without filter	5.0 L (5.3 qt., 4.4 Imp.qt.)

*: The engine oil capacity is a reference quantity to be used when changing the engine oil. Warm up and turn off the engine, wait more than 5 minutes, and check the oil level on the dipstick

■ **Engine oil selection**

“Toyota Genuine Motor Oil” is used in your Toyota vehicle. Use Toyota approved “Toyota Genuine Motor Oil” or equivalent to satisfy the following grade and viscosity.

Oil grade:

0W-20, 5W-20, 5W-30 and 10W-30:

API grade SL “Energy-Conserving”, SM “Energy-Conserving” or SN “Resource-Conserving”; or ILSAC multigrade engine oil

15W-40 and 20W-50:

API grade SL, SM or SN multigrade engine oil

Recommended viscosity (SAE):

Except for Russia:

If you use SAE 10W-30 or a higher viscosity engine oil in extremely low temperatures, the engine may become difficult to start, so SAE 0W-20, 5W-20 or 5W-30 engine oil is recommended.

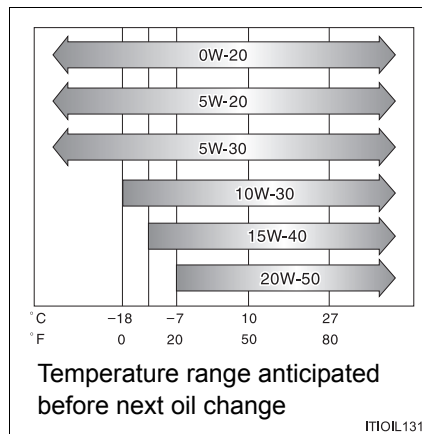

For Russia:

If you use SAE 10W-30 or a higher viscosity engine oil in extremely low temperatures, the engine may become difficult to start, so SAE 0W-20, 5W-20 or 5W-30 engine oil is recommended.

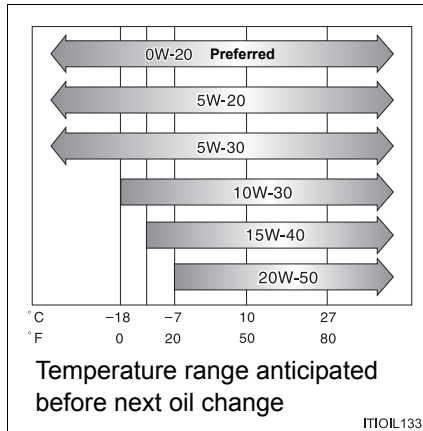

Oil viscosity (0W-20 is explained here as an example):

- The 0W in 0W-20 indicates the characteristic of the oil which allows cold startability. Oils with a lower value before the W allow for easier starting of the engine in cold weather.
- The 20 in 0W-20 indicates the viscosity characteristic of the oil when the oil is at high temperature. An oil with a higher viscosity (one with a higher value) may be better suited if the vehicle is operated at high speeds, or under extreme load conditions.

How to read oil container labels:

Either or both API registered marks are added to some oil containers to help you select the oil you should use.

① API Service Symbol

Top portion: "API SERVICE SN" means the oil quality designation by American Petroleum Institute (API).

Center portion: "SAE 0W-20" means the SAE viscosity grade.

Lower portion: "Resource-Conserving" means that the oil has fuel-saving and environmental protection capabilities.

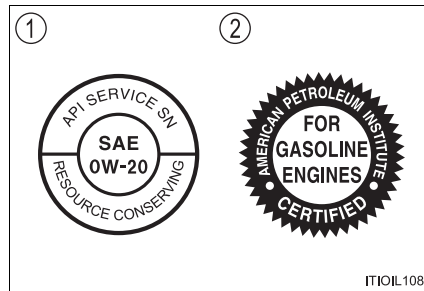

② ILSAC Certification Mark

The International Lubricant Specification Advisory Committee (ILSAC) Certification Mark is displayed on the front of the container.

► 1KD-FTV engine

Oil capacity (Drain and refill — reference*1)	
With filter	7.0 L (7.4 qt., 6.2 Imp.qt.)
Without filter	6.7 L (7.1 qt., 5.9 Imp.qt.)

*1: The engine oil capacity is a reference quantity to be used when changing the engine oil. Warm up and turn off the engine, wait more than 5 minutes, and check the oil level on the dipstick.

■ Engine oil selection (vehicles with DPF catalytic converter*2)

*2: To determine whether or not your vehicle has a DPF system, contact any authorized Toyota dealer or repairer, or another duly qualified and equipped professional.

“Toyota Genuine Motor Oil” is used in your Toyota vehicle. Toyota recommends the use of approved “Toyota Genuine Motor Oil”. Another motor oil of matching quality can also be used.

Oil grade: AECA C2

 NOTICE

Using engine oil other than ACEA C2 may damage the catalytic converter.

Recommended viscosity (SAE):

SAE 0W-30 is filled into your Toyota vehicle at manufacturing, and the best choice for good fuel economy and good starting in cold weather.

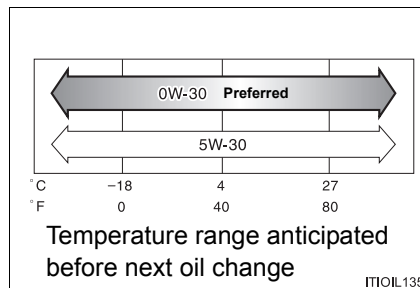

Oil viscosity (0W-30 is explained here as an example):

- The 0W in 0W-30 indicates the characteristic of the oil which allows cold startability. Oils with a lower value before the W allow for easier starting of the engine in cold weather.
- The 30 in 0W-30 indicates the viscosity characteristic of the oil when the oil is at high temperature. An oil with a higher viscosity (one with a higher value) may be better suited if the vehicle is operated at high speeds, or under extreme load conditions.

■ **Engine oil selection (vehicles without DPF catalytic converter*³)**

*³: To determine whether or not your vehicle has a DPF system, contact any authorized Toyota dealer or repairer, or another duly qualified and equipped professional.

“Toyota Genuine Motor Oil” is used in your Toyota vehicle. Use Toyota approved “Toyota Genuine Motor Oil” or equivalent to satisfy the following grade and viscosity.

Oil grade: API CF-4, CF or ACEA B1

Recommended viscosity (SAE):

SAE 5W-30 is the best choice for good fuel economy and good starting in cold weather.

If you use SAE 10W-30 or a higher viscosity engine oil in extremely low temperatures, the engine may become difficult to start, so SAE 5W-30 engine oil is recommended.

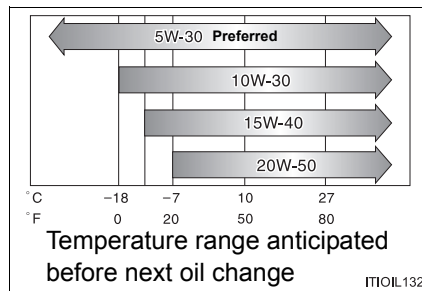

Oil viscosity (5W-30 is explained here as an example):

- The 5W in 5W-30 indicates the characteristic of the oil which allows cold startability. Oils with a lower value before the W allow for easier starting of the engine in cold weather.
- The 30 in 5W-30 indicates the viscosity characteristic of the oil when the oil is at high temperature. An oil with a higher viscosity (one with a higher value) may be better suited if the vehicle is operated at high speeds, or under extreme load conditions.

Cooling system

Capacity (Reference)	1GR-FE engine	With ATF warmer	▶ With rear heater 12.8 L (13.5 qt., 11.3 Imp.qt.) ▶ Without rear heater 11.0 L (11.6 qt., 9.7 Imp.qt.)
		Without ATF warmer	▶ With rear heater 12.3 L (13.0 qt., 10.8 Imp.qt.) ▶ Without rear heater 10.5 L (11.1 qt., 9.2 Imp.qt.)
	2TR-FE engine	With automatic transmission	▶ With rear heater 9.9 L (10.5 qt., 8.7 Imp.qt.) ▶ Without rear heater 8.1 L (8.6 qt., 7.1 Imp.qt.)
		With manual transmission	▶ With rear heater 10.1 L (10.7 qt., 8.9 Imp.qt.) ▶ Without rear heater 8.3 L (8.8 qt., 7.3 Imp.qt.)

Capacity (Reference)	1KD-FTV engine	With automatic transmission	▶ With rear heater 14.9 L (15.7 qt., 13.1 Imp.qt.) ▶ Without rear heater 13.1 L (13.8 qt., 11.5 Imp.qt.)
		With manual transmission	▶ With rear heater 15.0 L (15.9 qt., 13.2 Imp.qt.) ▶ Without rear heater 13.2 L (13.9 qt., 11.6 Imp.qt.)
Coolant type		Use either of the following. <ul style="list-style-type: none"> • “Toyota Super Long Life Coolant” • A similar high-quality ethylene glycol-based non-silicate, non-amine, non-nitrite, and non-borate coolant with long-life hybrid organic acid technology Do not use plain water alone.	

Ignition system (spark plug of the gasoline engine)

Make	1GR-FE engine	DENSO SK16HR11
	2TR-FE engine	DENSO SK20HR-A11
Gap		1.1 mm (0.043 in.)

 NOTICE

■ **Iridium-tipped spark plugs**

Use only iridium-tipped spark plugs. Do not adjust the spark plug gap.

Electrical system■ **Battery**

Specific gravity reading at 20°C (68°F):	1.250 — 1.290 Fully charged
	1.160 — 1.200 Half charged
	1.060 — 1.100 Discharged

■ **Charging rates**

Quick charge	15 A max.
Slow charge	5 A max.

Front differential

Oil capacity	1.40 L (1.48 qt., 1.23 Imp.qt.)
Oil type and viscosity*	Toyota Genuine Differential Gear Oil LT 75W-85 GL-5 or equivalent

*: Your Toyota vehicle is filled with “Toyota Genuine Differential Gear Oil” at the factory.

Use Toyota approved “Toyota Genuine Differential Gear Oil” or an equivalent of matching quality to satisfy the above specification. Please contact any authorized Toyota dealer or repairer, or another duly qualified and equipped professional for further details.

Rear differential

Oil capacity	5-door models	With rear differential lock system	2.65 L (2.80 qt., 2.33 Imp.qt.)
		Without rear differential lock system	2.70 L (2.85 qt., 2.38 Imp.qt.)
	3-door models		2.20 L (2.32 qt., 1.94 Imp.qt.)
Oil type and viscosity*			Toyota Genuine Differential Gear Oil LT 75W-85 GL-5 or equivalent

*: Your Toyota vehicle is filled with “Toyota Genuine Differential Gear Oil” at the factory.

Use Toyota approved “Toyota Genuine Differential Gear Oil” or an equivalent of matching quality to satisfy the above specification. Please contact any authorized Toyota dealer or repairer, or another duly qualified and equipped professional for further details.

Automatic transmission

Fluid capacity*	1GR-FE engine	10.9 L (11.5 qt., 9.6 Imp.qt.)
	2TR-FE engine	9.9 L (10.5 qt., 8.7 Imp.qt.)
	1KD-FTV engine	10.6 L (11.2 qt., 9.3 Imp.qt.)
Fluid type		Toyota Genuine ATF WS

*: The fluid capacity is a reference quantity. If replacement is necessary, contact any authorized Toyota dealer or repairer, or another duly qualified and equipped professional.

 **NOTICE**

■ **Transmission fluid type**

Using transmission fluid other than “Toyota Genuine ATF WS” may cause shift quality, locking up of the transmission accompanied by vibration and, ultimately, damage to the vehicle's transmission.

Manual transmission

▶ 5-speed models

Gear oil capacity	2.2 L (2.3 qt., 1.9 Imp.qt.)
Gear oil type	Gear oil API GL-4
Recommended gear oil viscosity	SAE 75W-90

▶ 6-speed models

Gear oil capacity	2.1 L (2.2 qt., 1.8 Imp.qt.)
Gear oil type	Toyota Genuine Transfer Gear oil LF or equivalent
Recommended gear oil viscosity	SAE 75W

 NOTICE

■ **Manual transmission gear oil (6-speed models)**

Using manual transmission gear oil other than “TOYOTA Genuine Transfer Gear oil LF SAE 75W” may cause occurrences of gear noise or other types of deterioration.

Clutch

Clutch pedal free play	5 — 15 mm (0.2 — 0.6 in.)
Fluid type	<ul style="list-style-type: none"> • SAE J1703 or FMVSS No.116 DOT 3 • SAE J1704 or FMVSS No.116 DOT 4

Transfer

Oil capacity	1.4 L (1.5 qt., 1.2 Imp.qt.)
Oil type*	Toyota Genuine Transfer Gear oil LF or equivalent
Recommended oil viscosity	SAE 75W

*: Your Toyota vehicle is filled with “Toyota Genuine Transfer Gear oil LF” at the factory. Use Toyota approved “Toyota Genuine Transfer Gear oil LF” or an equivalent of matching quality to satisfy the above specification. Please contact any authorized Toyota dealer or repairer, or another duly qualified and equipped professional for further details.

Brakes

Pedal clearance*1	1GR-FE and 1KD-FTV engines	Left-hand drive	▶ With automatic transmission 101 mm (4.0 in.) Min. ▶ With manual transmission 94 mm (3.7 in.) Min.
		Right-hand drive	101 mm (4.0 in.) Min.
	2TR-FE engine		▶ With automatic transmission 105 mm (4.1 in.) Min. ▶ With manual transmission 102 mm (4.0 in.) Min.
Pedal free play			1 — 6 mm (0.04 — 0.24 in.)
Parking brake lever travel*2			5 — 7 clicks
Fluid type			<ul style="list-style-type: none"> • SAE J1703 or FMVSS No. 116 DOT 3 • SAE J1704 or FMVSS No. 116 DOT 4

*1: Minimum pedal clearance when depressed with a force of 490 N (50 kgf, 110 lbf) while the engine is running

*2: Parking brake lever travel when pulled up with a force of 200 N (20.4 kgf, 45.0 lbf)

Chassis lubrication (Propeller shafts)

Spider	Lithium base chassis grease, NLGI No.2
Slide yoke	Molybdenum-disulfide lithium base chassis grease, NLGI No.2 or lithium base chassis grease, NLGI No.2

Steering

Free play	Less than 30 mm (1.18 in.)
Power steering fluid type	Automatic transmission fluid DEXRON® II or III

Tires and wheels

► 17-inch tires (type A)

Tire size	P245/70R17 108S, 245/70R17 110S	
Tire inflation pressure (Recommended cold tire inflation pressure)	Front tire kPa (kgf/cm ² or bar, psi)	Rear tire kPa (kgf/cm ² or bar, psi)
	220 (2.2, 32)	220 (2.2, 32)
Wheel size	17 × 6 1/2J	
Wheel nut torque	112 N•m (11.4 kgf•m, 83 ft•lbf)	

► 17-inch tires (type B)

Tire size	245/70R17 110S	
Tire inflation pressure (Recommended cold tire inflation pressure)	Front tire kPa (kgf/cm ² or bar, psi)	Rear tire kPa (kgf/cm ² or bar, psi)
	200 (2.0, 29)	200 (2.0, 29) 220 (2.2, 32)*
Wheel size	17 × 6 1/2J	
Wheel nut torque	112 N•m (11.4 kgf•m, 83 ft•lbf)	

*: Standard inflation for all loads including full rated loads

► 17-inch tires (type C)

Tire size	P265/65R17 112S, 265/65R17 112S	
Tire inflation pressure (Recommended cold tire inflation pressure)	Front tire kPa (kgf/cm ² or bar, psi)	Rear tire kPa (kgf/cm ² or bar, psi)
	220 (2.2, 32)	220 (2.2, 32)
Wheel size	17 × 7 1/2J	
Wheel nut torque	112 N•m (11.4 kgf•m, 83 ft•lbf)	

► 17-inch tires (type D)

Tire size	265/65R17 112S	
Tire inflation pressure (Recommended cold tire inflation pressure)	Front tire kPa (kgf/cm ² or bar, psi)	Rear tire kPa (kgf/cm ² or bar, psi)
	200 (2.0, 29)	200 (2.0, 29)
Wheel size	17 × 7 1/2J	
Wheel nut torque	112 N•m (11.4 kgf•m, 83 ft•lbf)	

► 18-inch tires (type A)

Tire size	P265/60R18 109H, 265/60R18 110H	
Tire inflation pressure (Recommended cold tire inflation pressure)	Front tire kPa (kgf/cm ² or bar, psi)	Rear tire kPa (kgf/cm ² or bar, psi)
	220 (2.2, 32)	220 (2.2, 32)
Wheel size	18 × 7 1/2J	
Wheel nut torque	112 N•m (11.4 kgf•m, 83 ft•lbf)	

► 18-inch tires (type B)

Tire size	265/60R18 110H	
Tire inflation pressure (Recommended cold tire inflation pressure)	Front tire kPa (kgf/cm ² or bar, psi)	Rear tire kPa (kgf/cm ² or bar, psi)
	200 (2.0, 29)	200 (2.0, 29) 220 (2.2, 32)*
Wheel size	18 × 7 1/2J	
Wheel nut torque	112 N•m (11.4 kgf•m, 83 ft•lbf)	

*: Standard inflation for all loads including full rated loads

Light bulbs

	Light bulbs	W	Type
Exterior	Headlights Low beam (halogen bulbs*) High beam	55 60	A B
	Front fog lights*	19	C
	Front turn signal lights	21	D
	Front position lights (halogen bulbs*)	5	E
	Rear turn signal lights	21	D
	Back-up lights	16	E
	Rear fog lights*	21	E
	License plate lights	5	E
	Running board lights*	5	E
Interior	Personal/interior lights Front Rear (without personal lights)* Rear (with personal lights)*	5 8 5	E F E
	Vanity lights	8	E

A: H11 halogen bulbs

B: HB3 halogen bulbs

C: H16 halogen bulbs

D: Wedge base bulbs (amber)

E: Wedge base bulbs (clear)

F: Double end bulbs

*: If equipped

Fuel information

◆ Gasoline engine

▶ 1GR-FE engine

EU area:

Your vehicle must use only unleaded gasoline conforming to European standard EN228.

For optimum engine performance, select unleaded gasoline with a Research Octane Number of 95 or higher.

Except EU area:

Your vehicle must use only unleaded gasoline.

For optimum engine performance, select unleaded gasoline with a Research Octane Number of 95 or higher.

▶ 2TR-FE engine

EU area:

Your vehicle must use only unleaded gasoline conforming to European standard EN228.

For optimum engine performance, select unleaded gasoline with a Research Octane Number of 91 or higher.

Except EU area:

Your vehicle must use only unleaded gasoline.

For optimum engine performance, select unleaded gasoline with a Research Octane Number of 91 or higher.

◆ Diesel engine

EU area:

Your vehicle must use only diesel fuel conforming to European standard EN590.

Except EU area:

Without DPF system*

Your vehicle must use only diesel fuel that contains 350 ppm or less of sulfur and has a cetane number of 48 or higher.

With DPF system*

Your vehicle must use only diesel fuel that contains 50 ppm or less of sulfur and has a cetane number of 48 or higher.

*: To determine whether or not your vehicle has a DPF system, contact any authorized Toyota dealer or repairer, or another duly qualified and equipped professional.

■ Fuel tank opening for unleaded gasoline

To help prevent incorrect fueling, your vehicle has a fuel tank opening that only accommodates the special nozzle on unleaded fuel pumps.

■ If you plan to drive in foreign countries

Low sulphur diesel fuel may not be available, so please check the availability with your distributor.

■ If your engine knocks

- Consult any authorized Toyota dealer or repairer, or another duly qualified and equipped professional.
- You may occasionally notice light knocking for a short time while accelerating or driving uphill. This is normal and there is no need for concern.

 NOTICE**■ Notice on fuel quality**

- Do not use improper fuels. If improper fuels are used, the engine will be damaged.
 - Gasoline engine: Do not use leaded gasoline.
Leaded gasoline will cause the three-way catalytic converter to lose its effectiveness and the emission control system to function improperly.
 - Diesel engine:
Without DPF system*
Do not use a fuel that contains more than 350 ppm of sulfur.
Use of such a high sulfur fuel may damage the engine.
With DPF system*
Do not use a fuel that contains more than 50 ppm of sulfur.
Use of such a high sulfur fuel may damage the engine.
 - Gasoline engine (EU area): Bioethanol fuel sold under names such as “E50” or “E85” and fuel containing a large amount of ethanol should not be used. The use of these fuels will damage the vehicle’s fuel system. In case of any doubt, ask any authorized Toyota dealer or repairer, or another duly qualified and equipped professional.
 - Gasoline engine (except EU area): Bioethanol fuel sold under names such as “E50” or “E85” and fuel containing a large amount of ethanol should not be used. Your vehicle can use gasoline mixed with 10 % max ethanol. The use of fuel with more than 10 % ethanol content (E10) will damage the vehicle’s fuel system. You must ensure that refueling is carried out only from a source where fuel specification and quality can be guaranteed. In case of any doubt, ask any authorized Toyota dealer or repairer, or another duly qualified and equipped professional.
 - Diesel engine (EU area): FAME (Fatty Acid Methyl Ester) fuel sold under names such as “B30” or “B100” and fuel containing a large amount of FAME should not be used. The use of these fuels will damage the vehicle’s fuel system. In case of any doubt, ask any authorized Toyota dealer or repairer, or another duly qualified and equipped professional.
 - Diesel engine (except EU area): FAME (Fatty Acid Methyl Ester) fuel sold under names such as “B30” or “B100” and fuel containing a large amount of FAME should not be used. Your vehicle can use diesel mixed with 5 % max biodiesel FAME (B5). The use of fuel with more than 5 % FAME content (B5) will damage the vehicle’s fuel system. You must ensure that refueling is carried out only from a source where fuel specification and quality can be guaranteed. In case of any doubt, ask any authorized Toyota dealer or repairer, or another duly qualified and equipped professional.
- *: To determine whether or not your vehicle has a DPF system, contact any authorized Toyota dealer or repairer, or another duly qualified and equipped professional.

Customizable features

Your vehicle includes a variety of electronic features that can be personalized to suit your preferences. The settings of these features can be changed by using the steering wheel switches or at any authorized Toyota dealer or repairer, or another duly qualified and equipped professional.

It is also possible to customize certain vehicle features yourself using the menu switch and the “ENTER” switch.

Customizing vehicle features

When customizing vehicle features, ensure that the vehicle is parked in a safe place with the shift lever in P (automatic transmission) or N (manual transmission) and the parking brake set.

■ Changing by using the menu switch and the “ENTER” switch

- 1 Press and hold the menu switch to display customization mode. (→P. 116)
- 2 Press the “ENTER” switch upwards or downwards to select the item to be customized.
Press the “ENTER” switch to confirm.
- 3 Press the “ENTER” switch upwards or downwards to select the desired setting for the item being customized.
Press the “ENTER” switch to confirm.

When customization is completed, press the menu switch to clear the customization screen.

Customizable features

Some function settings are changed simultaneously with other functions being customized. Contact any authorized Toyota dealer or repairer, or another duly qualified and equipped professional for further details.

- ① Settings that can be changed using the menu switch and the “ENTER” switch
- ② Settings that can be changed by any authorized Toyota dealer or repairer, or another duly qualified and equipped professional

Definition of symbols: O = Available, – =Not available

■ **Door lock (→P. 131, 661)**

Function	Default setting	Customized setting	①	②
Unlocking using a key	All doors unlocked in one step	Driver's door unlocked in one step, all doors unlocked in two steps	–	O
Speed linked door locking function*	On	Off	O	O
Shift position linked door locking function*	Off	On	O	O
Shift position linked door unlocking function*	Off	On	O	O
Driver's door linked door unlocking function*	Off	On	O	O

*: If equipped

■ **Smart entry & start system* and wireless remote control**
 (→P. 154, 127)

Function	Default setting	Customized setting	①	②
Operation signal (buzzer)	Level 7	Off	O	O
		Level 1 to 6		
Operation signal (Emergency flashers)	On	Off	O	O
Time elapsed before the automatic door lock function is activated if a door is not opened after being unlocked	30 seconds	60 seconds	-	O
		120 seconds		
Open door warning function (When locking the vehicle)	On	Off	-	O
Glass hatch opening operation	Push and hold (Short)	Push twice	-	O
		One short push		
		Push and hold (Long)		
		Off		

*: If equipped

■ **Smart entry & start system* (→P. 154)**

Function	Default setting	Customized setting	①	②
Smart door unlocking	All the doors	Driver's door	O	O
Smart entry & start system	On	Off	O	O

*: If equipped

■ **Wireless remote control (→P. 127)**

Function	Default setting	Customized setting	①	②
Wireless remote control	On	Off	–	○
Unlocking operation	All doors unlocked in one step	Driver's door unlocked in one step, all doors unlocked in two steps	○	○

■ **Driving position memory* (→P. 189)**

Function	Default setting	Customized setting	①	②
Selecting the door linking driving position memory with door unlock operation	Driver's door	All doors	–	○

*: If equipped

■ **Automatic light control system* (→P. 268)**

Function	Default setting	Customized setting	①	②
Time elapsed before the headlights turn off	30 seconds	Off	○	○
		60 seconds		
		90 seconds		
Light sensor sensitivity	Standard	-2 to 2	○	○
Time elapsed before headlights automatically turn on*	Standard	Long	–	○

*: If equipped

■ Interior lights (→P. 477)

Function	Default setting	Customized setting	①	②
Time elapsed before the interior lights turn off	15 seconds	Off	○	○
		7.5 seconds		
		30 seconds		
Operation after the engine switch is turned to the "LOCK" position (without a smart entry & start system) or turned off (with a smart entry & start system)	On	Off	-	○
Operation when the doors are unlocked with the smart entry & start system or wireless remote control	On	Off	-	○
Operation when you approach the vehicle with the electronic key on your person *2	On	Off	-	○
Shift lever light	On	Off	-	○
Operation of the footwell lights *1	On	Off	-	○
Lounge illumination control *1	On	Off	-	○

*1: If equipped

*2: For vehicles with a smart entry & start system

■ Exterior lights* (→P. 477)

Function	Default setting	Customized setting	①	②
Time elapsed before the exterior lights turn off	15 seconds	Off	O	O
		7.5 seconds		
		30 seconds		
Running board lights	On	Off	-	O
Operation when you approach the vehicle with the electronic key on your person	On	Off	-	O
Operation when the doors are unlocked with the smart entry & start system or wireless remote control	On	Off	-	O
Operation when the doors are unlocked with the power door lock switch	On	Off	-	O
Operation when the door is opened	On	Off	-	O

*: If equipped

■ Meters (→P. 106)

Function	Default setting	Customized setting	①	②
Sensitivity of the ambient light sensor used for dimming the meter lights etc.*	Standard	-2 to 2	-	0
Sensitivity of the ambient light sensor used for brightening the meter lights etc.*	Standard	-2 to 2	-	0

■ Front automatic air conditioning system* (→P. 459)

Function	Default setting	Customized setting	①	②
Switching between outside air and recirculated air mode linked to automatic mode button operation	Auto	Manual	-	0
A/C automatic mode button operation	Auto	Manual	-	0

*: If equipped

■ Power windows (→P. 204) and moon roof*^{1, 2} (→P. 207)

Function	Default setting	Customized setting	①	②
Mechanical key linked operation (close)	Off	On	-	0
Mechanical key linked operation (open)	Off	On	-	0
Wireless remote control linked operation* ¹ (close)	Off	On	-	0
Wireless remote control linked operation* ¹ (open)	Off	On	-	0
Wireless remote control linked operation (buzzer)* ¹	On	Off	-	0

*1: If equipped

*2: The moon roof operation settings will be automatically changed when the power window operation settings are changed

■ **Toyota parking assist-sensor*1 (→P. 313)**

Function	Default setting	Customized setting	*2	
			①	②
Detection distance of the front center sensor*3	Far	Near	–	○
Detection distance of the rear center sensor	Far	Near	–	○
Buzzer volume	Level 5	Level 1 to 5	–	○
Display setting	All sensors displayed	Display off	–	○

*1: If equipped

*2: Settings that can be changed using the navigation system or multimedia system (→P. 319)

*3: Settings that can be changed on vehicles with 8 sensor type system

■ **Alarm* (→P. 92)**

Function	Default setting	Customized setting	① ②	
			①	②
Sensitivity adjustment of the intrusion sensor when the window is open	Standard	Low	–	○
Deactivates the alarm when the doors are unlocked using the mechanical key (vehicles with a smart entry & start system)	Off	On	–	○

*: If equipped

■ Multi-information display (→P. 110, 115)

Function	Default setting	Customized setting	①	②
Language* ¹	English	French	○	○
		German		
		Spanish		
		Italian		
		Japanese* ²		
		Simplified Chinese* ²		
		Traditional Chinese		
		Russian		
	Turkish			
Units* ¹	km (L/100km)	km (km/L)	○	○
		mph (MPG)		
Eco Driving Indicator Light* ³	On	Off	○	○
Turn-by-turn navigation* ²	On	Off	○	○
Vehicle image* ²	Back door mounted spare tire image off	Back door mounted spare tire image on	○	○

*1: The default setting varies according to countries

*2: If equipped

*3: For vehicles with the multi-information display type A, the setting can be changed by the “ODO/TRIP” button (→P. 112)

■ **In the following situations, customize mode will automatically be turned off.**

- A warning message appears after the customize mode screen is displayed.
- The engine switch is turned to the “LOCK” position (without a smart entry & start system) or turned off (with a smart entry & start system).
- The vehicle begins to move while the customize mode screen is displayed.

 CAUTION

■ **During customization**

As the engine needs to be running during customization, ensure that the vehicle is parked in a place with adequate ventilation. In a closed area such as a garage, exhaust gases including harmful carbon monoxide (CO) may collect and enter the vehicle. This may lead to death or a serious health hazard.

 NOTICE

■ **During customization**

To prevent battery discharge, ensure that the engine is running while customizing features.

Items to initialize

The following item must be initialized for normal system operation after such cases as the battery being reconnected, or maintenance being performed on the vehicle:

Item	When to initialize	Reference
Tire pressure warning system	<ul style="list-style-type: none">• When rotating the tires• When changing the tire inflation pressure by changing traveling speed or load weight, etc.	P. 542

Index

718

What to do if...
(Troubleshooting).....718
Alphabetical index722

For vehicles with a navigation system or a multimedia system, refer to the “Navigation system owner’s manual” for information regarding the equipment listed below.

- Navigation system
- Hands-free system (for cellular phone)
- Rear seat entertainment system
- Audio/video system

What to do if... (Troubleshooting)

If you have a problem, check the following before contacting any authorized Toyota dealer or repairer, or another duly qualified and equipped professional.

The doors cannot be locked, unlocked, opened or closed



You lose your keys

- If you lose your keys or mechanical keys, new genuine keys or mechanical keys can be made by any authorized Toyota dealer or repairer, or another duly qualified and equipped professional. (→P. 129)
- Vehicles with a smart entry & start system
If you lose your electronic keys, the risk of vehicle theft increases significantly. Contact any authorized Toyota dealer or repairer, or another duly qualified and equipped professional immediately. (→P. 129)



The doors cannot be locked or unlocked

- Is the key battery weak or depleted? (→P. 560)
- Vehicles with a smart entry & start system
Is the engine switch in IGNITION ON mode?
When locking the doors, turn the engine switch off. (→P. 247)
- Vehicles with a smart entry & start system
Is the electronic key left inside the vehicle?
When locking the doors, make sure that you have the electronic key on your person.
- The function may not operate properly due to the condition of the radio wave. (→P. 140, 157)



The rear door cannot be opened

- Is the child-protector lock set?
The rear door cannot be opened from inside the vehicle when the lock is set. Open the rear door from outside and then unlock the child-protector lock. (→P. 136)

If you think something is wrong**The engine does not start
(vehicles without a smart entry & start system)**

- Vehicles with a manual transmission
Do you turn the key with the clutch pedal depressed firmly?
(→P. 241)
- Vehicles with an automatic transmission
Is the shift lever in P? (→P. 241)
- Is the battery discharged? (→P. 664)

**The engine does not start
(vehicles with a smart entry & start system)**

- Did you press the engine switch while firmly depressing the brake pedal?
(→P. 244)
- Vehicles with an automatic transmission
Is the shift lever in P? (→P. 244)
- Is the electronic key anywhere detectable inside the vehicle? (→P. 154)
- Is the steering wheel unlocked? (→P. 249)
- Is the electronic key battery weak or depleted?
In this case, the engine can be started in a temporary way.
(→P. 662)
- Is the battery discharged? (→P. 664)

**The shift lever cannot be shifted from P even if you depress
the brake pedal (vehicles with an automatic transmission)**

- Vehicles without a smart entry & start system
Is the engine switch in the "ON" position?
If you cannot release the shift lever by depressing the brake
pedal with the engine switch in the "ON" position: →P. 660
- Vehicles with a smart entry & start system
Is the engine switch in IGNITION ON mode?
If you cannot release the shift lever by depressing the brake pedal
with the engine switch in IGNITION ON mode: →P. 660



The steering wheel cannot be turned after the engine is stopped

- Vehicles without a smart entry & start system
It is locked to prevent theft of the vehicle if the key is removed from the engine switch. (→P. 243)
- Vehicles with a smart entry & start system
It is locked automatically to prevent theft of the vehicle.
(→P. 249)



The windows do not open or close by operating the power window switches

- Is the window lock switch pressed?
The power window except for the one at the driver's seat cannot be operated if the window lock switch is pressed. (→P. 204)



The engine switch is turned off automatically (vehicles with a smart entry & start system)

- The auto power off function will be operated if the vehicle is left in ACCESSORY or IGNITION ON mode (the engine is not operating) for a period of time. (→P. 248)



A warning buzzer sounds during driving

- The seat belt reminder light is flashing
Are the driver and the front passenger wearing the seat belts?
(→P. 598)
- The brake system warning light is on
Is the parking brake released? (→P. 265)

Depending on the situation, other types of warning buzzer may also sound. (→P. 595, 607)

**An alarm is activated and the horn sounds (if equipped)**

- Did anyone inside the vehicle open a door during setting the alarm?
The sensor detects it and the alarm sounds. (→P. 92)

To stop the alarm, turn the engine switch to IGNITION ON mode or start the engine.

**A warning buzzer sounds when leaving the vehicle (vehicles with a smart entry & start system)**

- Is the message displayed on the multi-information display?
Check the message on the multi-information display. (→P. 607)

**A warning light turns on or a warning message is displayed**

- When a warning light turns on or a warning message is displayed, refer to P. 595, 607.

When a problem has occurred**If you have a flat tire**

- Vehicles without a spare tire
Stop the vehicle in a safe place and repair the flat tire temporarily with the emergency tire puncture repair kit. (→P. 642)
- Vehicles with a spare tire
Stop the vehicle in a safe place and replace the flat tire with the spare tire. (→P. 623)

**The vehicle becomes stuck**

- Try the procedure for when the vehicle becomes stuck in mud, dirt, or snow. (→P. 674)

Alphabetical index

A

- A/C**..... 453, 459, 468, 470
 - Air conditioning filter..... 558
- Active Traction Control*1** 361
- ABS**
 - (Anti-lock Brake System)**..... 361
 - Function 361
 - Warning light 596
- Air conditioning filter** 558
- Air conditioning system** 453, 459, 468, 470
 - Air conditioning filter..... 558
- Airbags** 42
 - Airbag operating conditions 51
 - Airbag precautions
 - for your child 45
 - Airbag warning light 596
 - Correct driving posture..... 35
 - Curtain shield airbag
 - operating conditions 51
 - Curtain shield airbag precautions 45
 - General airbag precautions 45
 - Locations of airbags..... 42
 - Modification and disposal of airbags..... 50
 - Side airbag operating conditions 51
 - Side airbag precautions 45
 - Side and curtain shield airbags operating conditions 51
 - Side and curtain shield airbags precautions 45
 - SRS airbags..... 42
- Alarm** 92
 - Alarm 92
 - Warning buzzer..... 595
- Anchor brackets** 72
- Antennas (smart entry & start system)**..... 154
- Anti-lock brake system (ABS)** 361
 - Function 361
 - Warning light 596
- Armrest**..... 502
- Ashtray** 504
- Assist grip** 503
- Audio input**..... 395, 424
- Audio system*2** 393
 - Antenna 401
 - Audio input..... 395, 424
 - AUX port/USB port..... 395, 424
 - Bluetooth® audio..... 440
 - CD player..... 403
 - iPod..... 410
 - MP3/WMA disc 404
 - Optimal use..... 396
 - Portable music player 395
 - Radio 398
 - Steering wheel audio switch 430
 - USB memory 417
- Automatic headlight leveling system**..... 277
- Automatic light control system**..... 275
- Automatic transmission**..... 252
 - If the shift lever cannot be shifted from P 660
 - S mode 256
- AUX port**..... 395, 424
- Auxiliary boxes** 488
- AVS*1**

B

Back door	141
Back-up lights	
Replacing light bulbs	578
Wattage	702
Battery	532
Battery checking	532
If the vehicle battery is	
discharged	664
Preparing and checking	
before winter	388
Warning light	595
Bluetooth®	
Audio system	440
Hands-free system	
(for cellular phone)	442
Bottle holders	486
Brake	
Fluid	699
Parking brake	265
Warning light	595
Brake assist	361
Break-in tips	213
Brightness control	
Instrument panel light	
control	108
BSM (Blind Spot Monitor)	367

C

Care	507, 511
Aluminum wheels	508
Exterior	507
Interior	511
Seat belts	512
Cargo hooks	490

Center differential*1

CD player	402
Chains	388
Child restraint system	58
Baby seats, definition	59
Baby seats, installation	72
Child seats, definition	59
Child seats, installation	73
Installing CRS with	
ISOFIX rigid anchor	77
Installing CRS with	
seat belts	72
Installing CRS with	
top straps	78
Junior seats, definition	59
Junior seats, installation	75
Child safety	57
Airbag precautions	45
Back door precautions	145
Battery precautions	532, 669
Child restraint system	58
Glass hatch precaution	145
How your child should	
wear the seat belt	39
Installing child restraints	71
Moon roof precautions	211
Power window lock	
switch	204
Power window	
precautions	206
Rear door	
child-protectors	136
Removed key battery	
precautions	563
Seat belt precautions	40
Seat heater precautions	473

*1: Refer to the "Off-road driving Owner's manual".

*2: For vehicles with a navigation system or a multimedia system, refer to the "Navigation system owner's manual".

Child-protectors 136
 Back door child-protector
 lock 144
Cleaning
 Aluminum wheels 508
 Exterior 507
 Interior 511
 Seat belts 512
Clock 498
Coat hooks 502
Compass 118
Condenser 531
Console box 483
Cool box 494
Cooling system 529
 Engine overheating 670
Conversation mirror 497
Crawl Control^{*1}
Cruise control
 Cruise control 293
 Dynamic radar cruise
 control 297
Cup holders 485
Curtain shield airbags 42
Current fuel consumption 116
Customizable features 706

D

**DAC (Downhill Assist
 Control system)^{*1}**
**Daytime running light
 system** 275
Defogger
 Front windshield 454, 462
 Outside rear view
 mirrors 454, 462
 Rear window 454, 462

**Diesel particulate filter
 system** 266
Differential^{*1} 696
Dimension 677
Display
 Multi-information
 display 110, 115
 Trip information 111, 116
 Warning message 607
Do-it-yourself maintenance 517
Doors 131
 Automatic door locking
 and unlocking system 137
 Back door 141
 Back door child-protector
 lock 144
 Door glasses 204
 Door lock 131
 Open door warning
 buzzer 134
 Open door warning light 598
 Outside rear view mirrors 201
 Rear door child-protector 136
Double locking system 91
**Driver's seat position
 memory** 189
Driving 213
 AVS switch^{*1}
 Break-in tips 216
 Correct posture 35
 Procedures 213
 Winter drive tips 388
**Dynamic radar cruise
 control** 297

E

Eco Driving Indicator	113, 120
Electronic key	125
Battery-saving function	157
If the electronic key does not operate properly	661
Replacing the battery	560
Emergency, in case of	
If the electronic key does not operate properly	661
If the engine will not start	658
If the shift lever cannot be shifted from P	660
If the vehicle has discharged battery	664
If the warning buzzer sounds	595
If the warning light turns on	595
If you have a flat tire	623, 642
If you lose your keys	719
If you think something is wrong	593
If you run out of fuel and the engine stalls	673
If your vehicle becomes stuck	674
If your vehicle needs to be towed	588
If your vehicle overheats	670

Emergency flashers	585
---------------------------------	-----

Engine

Accessory mode	242, 247
Compartment	521
Engine switch	241, 244
Hood	520
How to start the engine	241, 244
Identification number	681
If the engine will not start	658
If you run out of fuel and the engine stalls	673
Ignition switch (engine switch)	241, 244
Overheating	670
Engine compartment cover	521
Engine coolant	529
Capacity	693
Checking	529
Preparing and checking before winter	388
Engine immobilizer system	83
Engine oil	525
Capacity	684
Checking	525
Preparing and checking before winter	388
Engine oil maintenance data	528
Engine switch	241, 244
Engine switch light	477

*1: Refer to the "Off-road driving Owner's manual".

*2: For vehicles with a navigation system or a multimedia system,
refer to the "Navigation system owner's manual".

F

Flat tire..... 623, 642
Floor mats 33
Fluid
 Automatic transmission..... 696
 Brake..... 699
 Clutch..... 698
 Steering..... 699
 Washer..... 536
Fog lights..... 278
 Replacing light bulbs..... 576
 Switch 278
 Wattage..... 702
Four-wheel drive system*1
Front passenger's seat belt reminder light 598
Front position lights 268
 Light switch 268
 Replacing light bulbs..... 573
 Wattage..... 702
Front seats 171
 Adjustment..... 171
 Cleaning..... 511
 Correct driving posture..... 35
 Driving position memory 189
 Head restraints..... 193
 Seat heaters..... 473
 Seat position memory 189
Front turn signal lights..... 264
 Replacing light bulbs..... 574
 Turn signal lever 264
 Wattage..... 702

Fuel 683
 Capacity..... 683
 Fuel gauge..... 106
 Fuel pump shut off system... 594
 If you run out of fuel and
 the engine stalls 673
 Information..... 703
 Refueling..... 289
 Type..... 289, 683
 Warning light..... 598
Fuel consumption information 123
Fuel filler door..... 289
 Refueling..... 289
Fuel filter 539
 Warning light..... 598, 598
Fuel gauge..... 106
Fuel pump shut off system..... 594
Fuses 564

G

Gauges 106
Glass hatch 148
Glove box 482

H

Hands-free system	
(for cellular phone)	442
Head restraints	193
Headlights	268
Light switch	268
Replacing light bulbs.....	571, 572
Wattage.....	702
Headlights cleaner	287
Heaters	
Manual air conditioning	
system	453, 468
Automatic air conditioning	
system	459, 470
Seat heaters.....	473
Outside rear view	
mirrors	454, 462
Height control *1	
Hill-start assist control *1	
Hood	520
Hooks	
Cargo hooks.....	490, 491
Coat hooks.....	502
Retaining hooks	
(floor mat)	33
Horn	197

I

Identification	
Engine.....	681
Vehicle	680
Ignition switch	
(engine switch)	241, 244
Ignition switch light	477
Illuminated entry system	480
Immobilizer system	83
Indicators	99
Initialization	
Moon roof.....	209
Power windows.....	205
Tire pressure warning	
system	541
Initiators (tire pressure	
warning system)	551
Inside rear view mirror	199
Instrument panel light	
control	108
Intercooler	531
Interior lights	477
Switch	478
Wattage	702

J

Jack	
Vehicle-equipped	
jack	624, 643
Jack handle	624, 643
Jam protection function	
Moon roof.....	208
Power windows.....	205

*1: Refer to the "Off-road driving Owner's manual".

*2: For vehicles with a navigation system or a multimedia system, refer to the "Navigation system owner's manual".

K

Keyless entry
 Smart entry & start system 131, 141
 Wireless remote control..... 131, 141
Keys 125
 Battery-saving function 157
 Electronic key..... 125
 Engine switch..... 241, 244
 If the electronic key does not operate properly 661
 If you lose your keys 719
 Key number plate..... 125
 Keyless entry 131, 141
 Mechanical key 129
 Replacing the battery 560
 Warning buzzer..... 134
 Wireless remote control 125
KDSS*1
 Warning light..... 597

L

Lever
 Auxiliary catch lever..... 520
 Hood lock release lever 520
 Shift lever..... 252
 Turn signal lever 264
 Wiper lever..... 280
License plate lights 268
 Light switch 268
 Replacing light bulbs..... 581
 Wattage 702
Light
 Engine switch light..... 477
 Fog light switch 278
 Headlight switch..... 268
 Illuminated entry system 480
 Interior light..... 478
 Interior light list..... 477
 Luggage compartment light..... 478
 Personal light 478
 Replacing light bulbs..... 568
 Turn signal lever 264
 Vanity lights 496
 Wattage 702
Light bulbs
 Replacing..... 568
 Wattage 702
Lock steering column 243, 249

M	N	
Maintenance Do-it-yourself maintenance 517 Maintenance data 677 Maintenance requirements..... 514 Malfunction indicator lamp..... 595 Manual transmission 259 Manual headlight leveling dial 269 Master warning light..... 607 Meter 106 Indicators 99 Instrument panel light control..... 108 Meters 106 Multi-information display 110, 115 Warning lights 99 Micro dust and pollen filter.... 463 Mirrors Inside rear view mirror 199 Outside rear view mirror defoggers..... 454, 462 Outside rear view mirrors..... 201 Vanity mirrors..... 496 Moon roof 207 Jam protection function..... 208 Operation 207 MP3 disc 402 Multi-information display 110, 115 Switching the display 111 Trip information..... 111, 116 Multi-terrain Monitor*1 Multi-terrain Select*1	Navigation system*2 <th style="text-align: center;">O</th> Odometer..... 106 Oil Engine oil 684 Front differential oil 695 Rear differential oil..... 696 Opener Back door..... 141 Fuel filler door 289 Hood 520 Outside rear view mirrors 201 Adjusting and folding 201 Blind spot monitor 367 Outside rear view mirror defoggers 454, 462 Outside temperature display..... 112, 118 Overheating, Engine..... 670	O

*1: Refer to the "Off-road driving Owner's manual".
 *2: For vehicles with a navigation system or a multimedia system,
 refer to the "Navigation system owner's manual".

P	
Parking assist sensors	313
Parking assist monitor	334
Parking brake	265
Operation	265
Parking brake engaged warning buzzer	595
Personal lights	477
Switch	478
Wattage.....	702
Power heater	456
Power outlet	499
Power steering	
Warning light.....	596
Power windows	204
Jam protection function.....	205
Operation	204
Window lock switch.....	204

R	
Radiator	531
Radio	398
Radio data system	399
RDS	399
Rear fog lights	278
Replacing light bulbs.....	580
Switch	278
Wattage	702
Rear differential *1	
Rear seat	174
Adjustment.....	174
Rear turn signal lights	264
Replacing light bulbs.....	578
Turn signal lever	264
Wattage	702
Rear view mirror	
Inside rear view mirror	199
Outside rear view mirrors.....	201
Rear view monitor system	323
Rear window	
defogger.....	454, 462
Rear window wiper	286
Refueling	289
Capacity.....	683
Fuel types	289, 683
Opening the fuel tank cap.....	292
Replacing	
Electronic key battery	560
Fuses.....	564
Light bulbs	568
Tires.....	623, 642
Wireless remote control battery	560
Reset the maintenance	
data.....	528
Roof luggage carrier	225

S

Seat belts	37
Adjusting the seat belt.....	38
Automatic Locking Retractor.....	39
Child restraint system installation.....	71
Cleaning and maintaining the seat belt.....	512
Emergency Locking Retractor.....	39
How to wear your seat belt	37
How your child should wear the seat belt.....	39
Pregnant women, proper seat belt use	40
Reminder light and buzzer	598
Seat belt pretensioners	38
SRS warning light	596
Seat heaters	475
Seat position memory	189
Seats	171, 174
Adjustment.....	171, 174
Adjustment precautions.....	173, 187
Child seats/child restraint system installation	71
Cleaning.....	511
Driving position memory	189
Head restraint	193
Properly sitting in the seat.....	35
Seat heaters.....	475
Seat position memory	189

Sensor

Automatic headlight system.....	275
Inside rear view mirror	200
Toyota parking assist-sensor	313
Rain-sensing windshield wipers	284
Service reminder indicators	99
Shift lever	
Automatic transmission.....	252
If the shift lever cannot be shifted from P	660
Shift lock system	660
Shopping bag hooks	491
Side airbags	42
Side mirrors	201
Adjusting and folding	201
Blind Spot Monitor	367
Side turn signal lights	264
Replacing light bulbs.....	578
Turn signal lever	264
Smart entry & start system	154
Antenna location	154
Starting the engine.....	241
Snow tires	390
Spare tire	623
Inflation pressure	553
Storage location	624
Spark plug	694
Specifications	677
Speedometer	106
Steering lock	
Column lock release	243, 249

*1: Refer to the "Off-road driving Owner's manual".

*2: For vehicles with a navigation system or a multimedia system, refer to the "Navigation system owner's manual".

Steering wheel	196	Heater idle up switch	455, 464
Adjustment	196	Height control button ^{*1}	
Audio switches	394	Ignition switch	241, 244
Steering wheel position		Intrusion sensor cancel	
memory	189	switch	95
Stop/tail lights		Light switches	268
Wattage	702	Moon roof switches	207
Storage feature	481	Multi-terrain Monitor switch ^{*1}	
Stuck		Multi-terrain Select	
If the vehicle becomes		ON/OFF switch ^{*1}	
stuck	674	Multi-terrain Select mode	
Sun shade		selector dial ^{*1}	
Roof	208	"ODO TRIP" button	108, 111
Sun visors	496	Outside rear view mirror	
Switch		switches	201
"2nd START" button	255	Parking assist	313
Airbag manual on-off		PCS off switch	380
system	55	Power door lock switch	135
Audio remote control		Power heater switch	456, 464
switches	430	Power window switch	204
AVS switch ^{*1}		Rear differential	
BSM (Blind spot monitor)		lock/unlock switch ^{*1}	
switch	367	Rear window wiper and	
Center differential		washer switch	286
lock/unlock switch ^{*1}		Rear window and outside	
Crawl Control ON/OFF		rear view mirror	
switch ^{*1}		defoggers switch	454, 462
Crawl Control speed		Seat heater switches	475
selector dial ^{*1}		Talk switch ^{*2}	
Cruise control switch	293, 297	Telephone switches	430
"DAC" switch ^{*1}		Tilt and telescopic steering	
Door lock switches	135	control switch	196
Driving position memory		Tire pressure warning	
switches	189	reset switch	541
Emergency flashers		Vehicle-to-vehicle distance	
switch	585	button	300
Engine switch	241, 244	VSC OFF switch ^{*1}	363
Fog light switch	278	Window lock switch	204
Four-wheel drive control		Windshield wipers and	
switch ^{*1}		washer switch	280
Headlight cleaner switch	287		

T

Tachometer	106
Tail lights	268
Light switch	268
Talk switch *2	
Telephone switch	430
Theft deterrent system	
Alarm	92
Engine immobilizer system	83
Tire inflation pressure	553
Maintenance data	553
Warning light	599
Tire pressure warning system	541
Function	541
Initializing	541
Installing tire pressure warning valves and transmitters	541
Registering ID codes	543
Tire pressure warning reset switch	541
Warning light	599
Tires	540
Chains	388
Checking	540
If you have a flat tire	623, 642
Inflation pressure	553
Replacing	623, 642
Rotating tires	540
Size	700
Snow tires	390
Spare tire	623
Tire pressure warning system	541
Warning light	599

Tools	624, 643
Top strap	78
Towing	
Emergency towing	588
Towing eyelet	588
Trailer Sway Control	362
Trailer towing	228
Trailer Sway Control	362
TRC (Traction Control)	361
Transmission	
Automatic transmission	252
AVS switch*1	
If the shift lever cannot be shifted from P	660
Trip information	111, 116
Trip meters	108
Turn signal lights	264
Replacing light bulbs	574, 578
Turn signal lever	264
Wattage	702

U

USB port	395
-----------------------	-----

V

Valet key	125
Vanity lights	496
Vanity lights	496
Wattage	702
Vanity mirrors	496
Vehicle identification number	680
VSC (Vehicle Stability Control)	361

*1: Refer to the "Off-road driving Owner's manual".

*2: For vehicles with a navigation system or a multimedia system, refer to the "Navigation system owner's manual".

W

Warning buzzers 595
 Brake system 595
 Downshifting 258
 Fuel system 598
 Key reminder 602
 Open back door 598
 Open door 598
 Seat belt reminder 598
Warning lights 595
 ABS 596
 Automatic headlight
 leveling system 600
 Automatic transmission
 fluid temperature 597
 Brake system 595
 Charging system 595
 Diesel particulate filter 600
 Engine oil change
 reminder 600
 Power steering 596
 Engine oil change
 reminder 600
 Fuel filter 598
 Fuel system warning light 598
 KDSS 597
 LED headlight 599
 Low engine oil level 599
 Low engine oil pressure 595
 Low fuel level 598
 Malfunction indicator
 lamp 595
 Master warning light 599
 Open door 598
 Parking brake indicator 595
 PCS 596
 Seat belt reminder light 598
 Slip indicator 597
 SRS 596
 Timing belt replacement 597
 Tire pressure 599

Toyota parking
 assist-sensor 600
 Windshield washer fluid 599
Warning reflector holder 490
Washer 280
 Checking 536
 Preparing and checking
 before winter 388
 Switch 280
Washing and waxing 507
Weight 677
Wheels 555
 Replacing wheels 555
 Size 700
Window glasses 204
Window lock switch 204
Windows 204
 Power windows 204
 Rear window
 defogger 454, 462
**Windshield wiper
 de-icer 455, 463**
Windshield wipers 280
 Intermittent windshield
 wipers with interval
 adjuster 280
 Rain-sensing windshield
 wipers 282
Winter driving tips 388
Wireless remote control 125
 Locking/Unlocking 131, 141
 Replacing the battery 560
WMA disc 402

GAS STATION INFORMATION

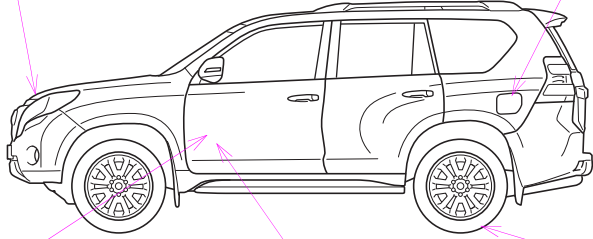
<p>Auxiliary catch lever</p> <p>P. 520</p>	<p>Fuel filler door</p> <p>P. 292</p>	
		
<p>Hood lock release lever</p> <p>P. 520</p>	<p>Fuel filler door opener</p> <p>P. 292</p>	<p>Tire inflation pressure</p> <p>P. 700</p>

IIEWPD001

Fuel tank capacity (Reference)	Vehicles with sub fuel tank system	150 L (39.6 gal., 33.0 Imp.gal.)
	Vehicles without sub fuel tank system	87 L (23.0 gal., 19.1 Imp.gal.)
Fuel type		P. 683
Cold tire inflation pressure		P. 700
Engine oil capacity (Drain and refill — reference)		P. 684
Engine oil type		P. 684