



Aygo X

Multimedia Manual



Toyota Motor Europe NV/SA Address: Avenue du bourget
60 -1140 Brussels, Belgium

2015 TOYOTA MOTOR CORPORATION All rights reserved. This material may not be reproduced or copied, in whole or in part, without the written permission of Toyota Motor Corporation

Quick guide	• Basic system overview	1
Basic function	• Information to be read before operation • Setting initial settings before operation • Connecting the Bluetooth® device	2
Audio/visual system	• Listening to the radio • Enjoying music and video	3
Speech command system	• Operating the speech command system	4
Peripheral monitoring system	• Checking the situation behind the vehicle	5
Phone	• Operating the phone (Hands-free system for cellular phones)	6
Index	• Search alphabetically	

2 TABLE OF CONTENTS

Introduction.....	4
Reading this manual.....	6

1 Quick guide

1-1. Basic function	
Buttons overview	10
“Menu” screen.....	13
Status icon	14
“Setup” screen	16

2 Basic function

2-1. Basic information before operation	
Initial screen.....	18
Touch screen	19
Home screen operation	21
Entering letters and numbers/list screen operation ...	22
Screen adjustment.....	25
Linking multi-information display and the system	27
2-2. Connectivity settings	
Registering/Connecting a Bluetooth® device	28
Setting Bluetooth® details.....	32
Connecting to Miracast® via Wi-Fi®.....	39
2-3. Apple CarPlay/Android Auto™	
Apple CarPlay/Android Auto ..	42
2-4. Other settings	
General settings.....	49
Voice settings.....	52
Vehicle settings.....	53

3 Audio/visual system

3-1. Basic operation	
Quick reference	56
Some basics	57
3-2. Radio operation	
FM/DAB radio	62
3-3. Media operation	
USB memory	67
iPod/iPhone (Apple CarPlay) ..	69
Android Auto	72
Bluetooth® audio.....	73
Miracast®	76
3-4. Audio/visual remote controls	
Steering switches.....	79
3-5. Setup	
Audio settings	80
3-6. Tips for operating the audio/visual system	
Operating information	81

4 Speech command system

4-1. Speech command system operation	
Speech command system	90
Command list.....	92

5	Peripheral monitoring system	1
5-1. Rear view monitor system		2
Rear view monitor system 96		3
Rear view monitor system precautions 98		4
Things you should know 102		5
6	Phone	6
6-1. Phone operation (Hands-free system for cellular phones)		5
Quick reference 106		6
Some basics 107		
Placing a call using the Bluetooth® hands-free system. 111		
Receiving a call using the Bluetooth® hands-free system. 115		
Talking on the Bluetooth® hands-free system 115		
Bluetooth® phone message function 117		
6-2. Setup		
Phone settings 122		
6-3. What to do if...		
Troubleshooting 131		
Index		
Alphabetical Index 136		

Introduction

Multimedia system owner's manual

This manual explains the operation of the system. Please read this manual carefully to ensure proper use. Keep this manual in your vehicle at all times.

The screen shots in this document and the actual screens of the system differ depending on whether the functions and/or a contract existed and the map data available at the time of producing this document.

The screens in this manual will also differ if the screen theme settings have been changed. (Theme setting: →P.49)

In some situations when changing between screens, it may take longer than normal for the screen to change, the screen may be blank momentarily or noise may be displayed.

Please be aware that the content of this manual may be different from the system in some cases, such as when the system's software is updated.



The company names and product names appearing on this manual are trademarks and registered trademarks of their respective companies.

TOYOTA MOTOR CORPORATION

Reading this manual

Explains symbols used in this manual

Symbols in this manual

Symbols	Meanings
	WARNING: Explains something that, if not obeyed, could cause death or serious injury to people.
	NOTICE: Explains something that, if not obeyed, could cause damage to or a malfunction in the vehicle or its equipment.
	Indicates operating or working procedures. Follow the steps in numerical order.

Symbols in illustrations

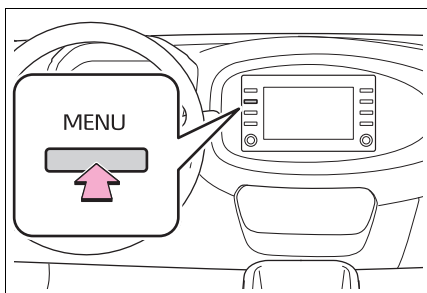

Symbols	Meanings
	Indicates the action (pushing, turning, etc.) used to operate switches and other devices.

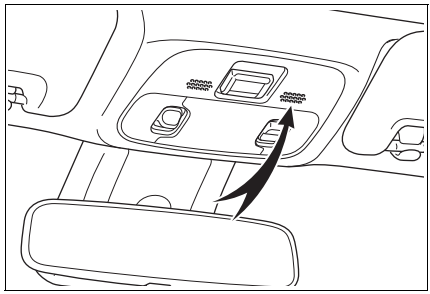

Symbols	Meanings
	Indicates the component or position being explained.

Safety instruction

To use this system in the safest possible manner, follow all the safety tips shown below.

Do not use any feature of this system to the extent it becomes a distraction and prevents safe driving. The first priority while driving should always be the safe operation of the vehicle. While driving, be sure to observe all traffic regulations.

Prior to the actual use of this system, learn how to use it and become thoroughly familiar with it. Read the entire manual to make sure you understand the system. Do not allow other people to use

this system until they have read and understood the instructions in this manual.

For your safety, some functions may become inoperable when driving. Unavailable screen buttons are dimmed.

**WARNING**

- Exercise extreme caution if operating the system while driving. Insufficient attention to the road, traffic or weather conditions may cause an accident.

Quick guide

1

9

1

Quick guide

1-1. Basic function

- Buttons overview 10
- "Menu" screen 13
- Status icon 14
- "Setup" screen 16

Buttons overview

Operations of each part

- ▶ 7-inch display model

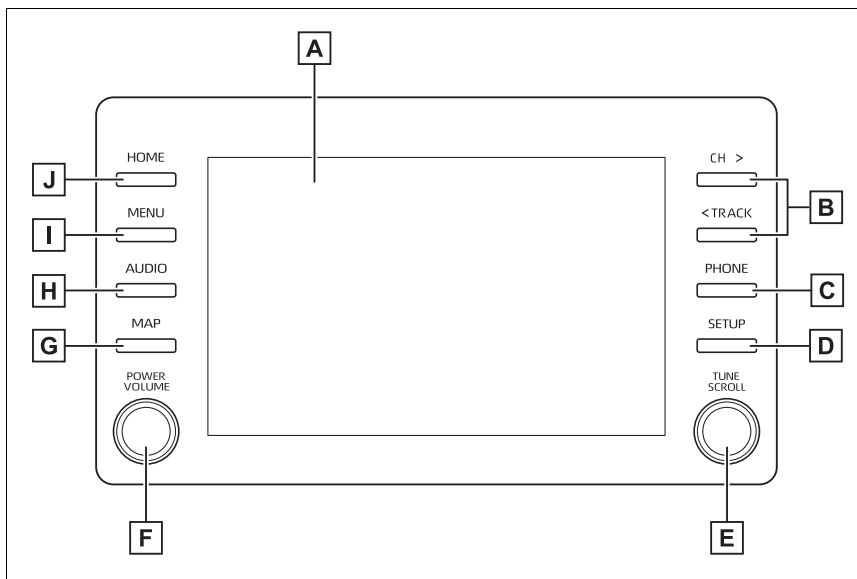

▶ 8-inch display model

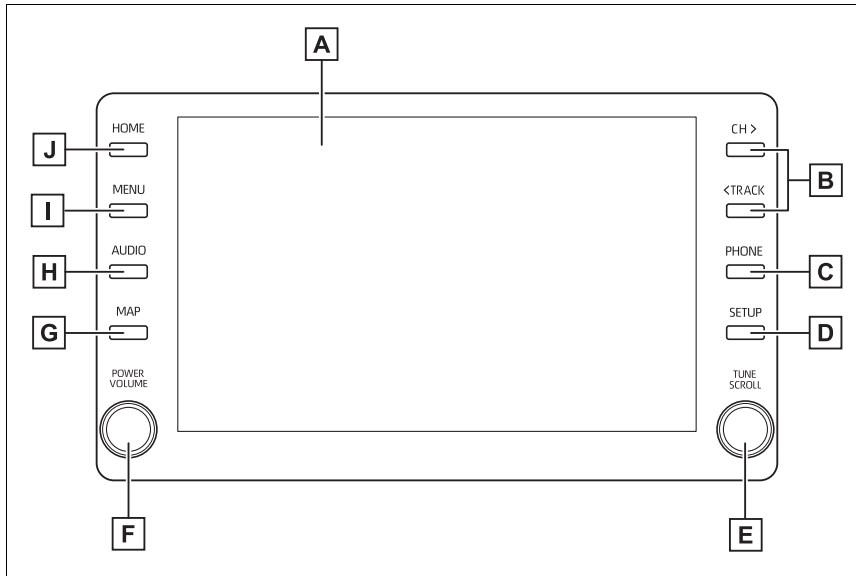

- A** By touching the screen with your finger, you can control the selected functions. (→P.19)
- B** Press to seek up or down for a radio station or to access a desired track/file. (→P.62, 67, 69, 73)
- C** Press to access the Bluetooth® hands-free system. (→P.106)
- When an Apple CarPlay connection is established, press to display the phone application screen.
- D** Press to display the “Setup” screen. (→P.16)
- E** Turn to change the radio station or skip to the next or previous track/file. (→P.62, 67, 69, 73)
- F** Press to turn the audio/visual system on and off, and turn it to adjust the volume. Press and hold to restart the system. (→P.18, 57)
- G** When an Apple CarPlay/Android Auto connection is established, press to display the Maps application screen.*1
- H** Press to access the audio/visual system. (→P.56, 57)
- I** Press to display the “Menu” screen. (→P.13)

12 1-1. Basic function

 Press to display the home screen. (→P.21)

*1: This function is not available in some countries or areas.

● This illustration is for left-hand drive vehicles. The button positions and shapes differ for right-hand drive vehicles.

“Menu” screen**Menu screen operation**

Press the “MENU” button to display the “Menu” screen.

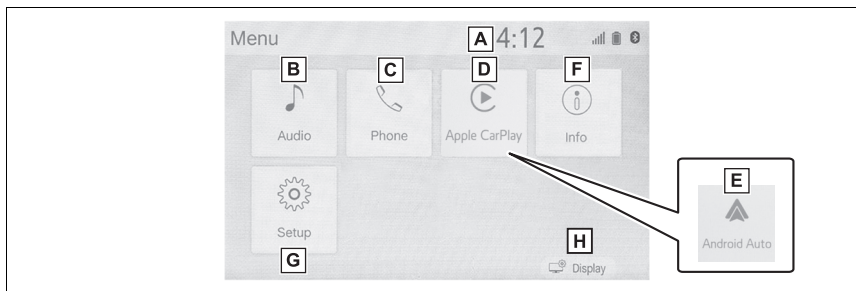

A Displays the clock. Select to display the clock settings screen. (→P.50)

B Select to display the audio control screen. (→P.56)

C Select to display the hands-free operation screen. (→P.106)

When an Apple CarPlay connection is established, select to display the phone application screen.^{*1}

D When an Apple CarPlay connection is established, select to display the home screen of Apple CarPlay.^{*1} (→P.42)

E When an Android Auto connection is established, select to display the home screen of Android Auto.^{*1} (→P.43)

F Select to display the fuel consumption screen.^{*2}

G Select to display the “Setup” screen. (→P.16)

H Select to adjust the contrast and brightness of the screens, etc. (→P.25)

^{*1}: This function is not made available in some countries or areas.

^{*2}: Refer to the “Owner’s Manual”.

Status icon

Status icons are displayed at the top of the screen.

Status icon explanation

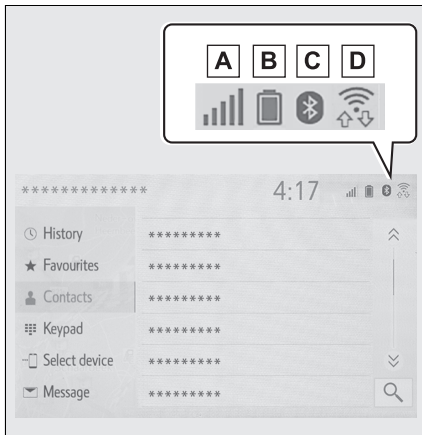

- A** The reception level of the connected phone display (→P.14)
- B** Remaining battery charge display (→P.15)
- C** Bluetooth® phone connection condition display (→P.15)
- D** Shown during data communication performed via Miracast® (→P.14)

● The number of status icons that can be displayed differs depending on the displayed screen.

Reception level display

The level of reception does not

always correspond with the level displayed on the cellular phone. The level of reception may not be displayed depending on the phone you have.

When the cellular phone is out of the service area or in a place inaccessible by radio waves, is displayed.

“Rm” is displayed when receiving in a roaming area. While roaming, display “Rm” top-left on the icon.

The receiving area may not be displayed depending on the type of Bluetooth® phone you have.

► While connected with cellular phone

Level	Indicators
Poor	
Excellent	

► When using Miracast®

Level	Indicators
No connection	
Poor	
Excellent	



● When Miracast® function is off, no item is displayed.

Remaining battery charge display

The amount displayed does not always correspond with the amount displayed on the Bluetooth® device.

The amount of battery charge left may not be displayed depending on the type of the Bluetooth® device connected.

This system does not have a charging function.

Remaining charge	Indicators
Empty	
Full	

Bluetooth® connection condition display

An antenna for the Bluetooth® connection is built into the instrument panel.



The condition of the Bluetooth® connection may deteriorate and the system may not function when a Bluetooth® phone is used in the following conditions and/or places:

The cellular phone is obstructed by certain objects (such as when it is behind the seat or in the glove box or console box).

The cellular phone is touching or is covered with metal materials.

Leave the Bluetooth® phone in a place where the condition of the

Bluetooth® connection is good.

Indicators	Conditions
 (Blue)	Indicates that the condition of the Bluetooth® connection is good.
 (Gray)	While in this condition, sound quality during phone calls may deteriorate.
	Indicates that the cellular phone is not connected via Bluetooth®.

“Setup” screen

“Setup” screen

Press the “SETUP” button, or press the “MENU” button, then select “Setup” to display the “Setup” screen. The items shown on the “Setup” screen can be set.

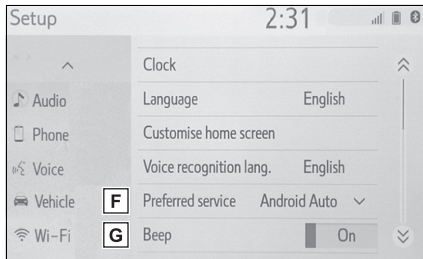
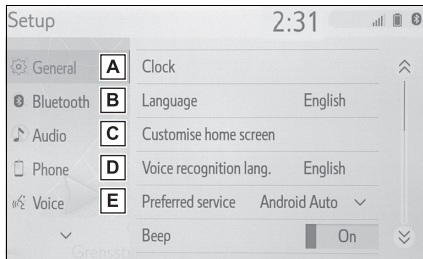

(→P.52)

F Select to set vehicle information.

(→P.53)

G Select to set Wi-Fi® connection settings. (→P.39)

A Select to change the selected language, operation sound settings, etc. (→P.49)

B Select to set Bluetooth® device and Bluetooth® system settings.(→P.32)

C Select to set audio settings. (→P.80)

D Select to set the phone sound, contacts settings, etc. (→P.122)

E Select to set the voice settings.

2-1. Basic information before operation	
Initial screen	18
Touch screen	19
Home screen operation	21
Entering letters and numbers/list screen operation	22
Screen adjustment.....	25
Linking multi-information display and the system.....	27
2-2. Connectivity settings	
Registering/Connecting a Bluetooth® device	28
Setting Bluetooth® details...	32
Connecting to Miracast® via Wi-Fi®	39
2-3. Apple CarPlay/Android Auto™	
Apple CarPlay/Android Auto	42
2-4. Other settings	
General settings	49
Voice settings	52
Vehicle settings.....	53

For vehicles sold outside Europe, some of the functions cannot be operated while driving.

Initial screen

When the engine switch is turned to ACC or ON, the initial screen will be displayed and the system will begin operating.

Caution screen

After a few seconds, the caution screen will be displayed.

After about 5 seconds or selecting “Continue”, the caution screen automatically switches to the next screen.

WARNING

- When the vehicle is stopped with the engine running, always apply the parking brake for safety.

Restarting the system

When system response is extremely slow, the system can be restarted.

- 1 Press and hold the “POWER VOLUME” knob for 3 seconds or more.

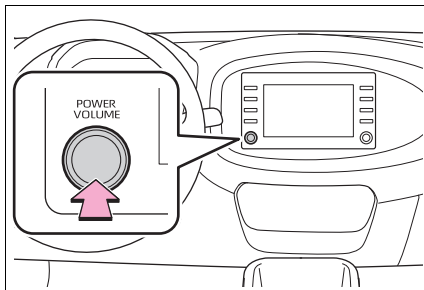

Touch screen

Touch screen gestures

Operations are performed by touching the touch screen directly with your finger.

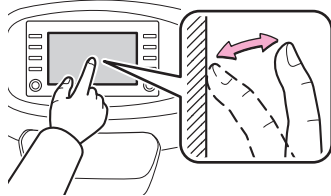
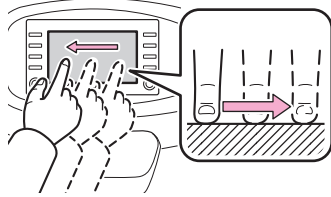
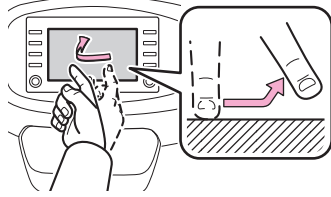
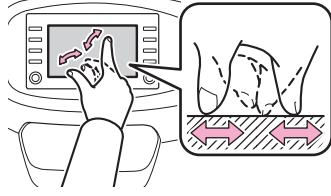
Operation method	Outline	Main use
	<ul style="list-style-type: none"> • Touch <p>Quickly touch and release once.</p>	<ul style="list-style-type: none"> • Selecting an item on the screen
	<ul style="list-style-type: none"> • Drag^{*1} <p>Touch the screen with your finger, and move the screen to the desired position.</p>	<ul style="list-style-type: none"> • Scrolling the lists • Moving an item on a list
	<ul style="list-style-type: none"> • Flick^{*1} <p>Quickly move the screen by flicking with your finger.</p>	<ul style="list-style-type: none"> • Scrolling the main screen page
	<ul style="list-style-type: none"> • Pinch in/Pinch out^{*2} <p>Slide fingers toward each other or apart on the screen.</p>	<ul style="list-style-type: none"> • Changing the scale of the map

*1: The above operations may not be performed on all screens.

*2: The Apple CarPlay Maps application is not compatible with pinch multi-touch gestures.

- Flick operations may not be performed smoothly at high altitudes.

Touch screen operation



This system is operated mainly by the buttons on the screen. (Referred to as screen buttons in this manual.)

When a screen button is touched, a beep sounds. (To set the beep sound: →P.49)

NOTICE

- To prevent damaging the screen, lightly touch the screen buttons with your finger.
- Do not use objects other than your finger to touch the screen.
- Wipe off fingerprints using a glass cleaning cloth. Do not use chemical cleaners to clean the screen, as they may damage the touch screen.
- Do not use the following liquids to clean the screen, as they may cause discoloration: Organic solutions, such as benzine, gasoline or alcohol, and alkaline solutions.

- If the system does not respond to touching a screen button, move your finger away from the screen and then touch it again.
- Dimmed screen buttons cannot be operated.
- The displayed image may become darker and moving images may be slightly distorted when the screen is cold.
- In extremely cold conditions, the screen may not be displayed and the data input by a user may be deleted. Also, the screen buttons may be harder than usual to depress.

- When you look at the screen through polarized material such as polarized sunglasses, the screen may be dark and hard to see. If so, look at the screen from different angles, adjust the screen settings on the display settings screen or take off your sunglasses.
- When  is displayed on the screen, select  to return to the previous screen.

Capacitive touch screen buttons

The operable areas of the capacitive touch screen buttons use capacitive touch sensors and may not operate properly in the following situations:

- If the screen is dirty or wet
- If a source of strong electromagnetic waves is brought near the screen
- If a glove is worn during operation
- If the screen is touched by a fingernail
- If a stylus is used to operate the buttons
- If your palm touches the operable area of another button during operation
- If a button is touched quickly
- If the operable part of a capacitive touch screen button is

touched by or covered with a metal object, such as the following, it may not operate properly:

- Magnetic isolation cards
- Metallic foil, such as the inner packaging of a cigarette box
- Metallic wallets or bags
- Coins
- Discs, such as a CD or DVD
- If the operable part of a capacitive touch screen button is wiped, it may operate unintentionally.
- If the capacitive touch screen button is being touched when the engine switch is changed to ACC or ON, the button may not operate properly. In this case, remove anything touching the button, turn the engine switch off and then turn it to ACC or ON, or restart the system by press and hold the “POWER VOLUME” knob for 3 seconds or more.

Home screen operation

On the home screen, multiple screens, such as the audio/visual system screen, hands-free screen and clock screen, can be displayed simultaneously.

Home screen operation

- 1 Press the “HOME” button.

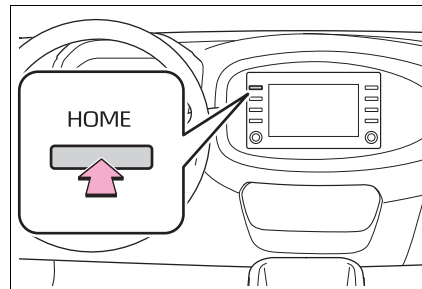

- 2 Check that the home screen is displayed.

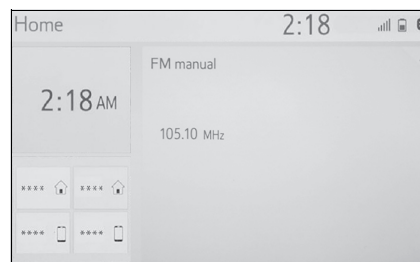

- Selecting a screen will display it full screen.
- The display information and area on the home screen can be customize.
- The home screen can be set to several types of split layouts.

Customizing the home screen

The display information/area on the home screen can be changed.

- 1 Press the "SETUP" button.

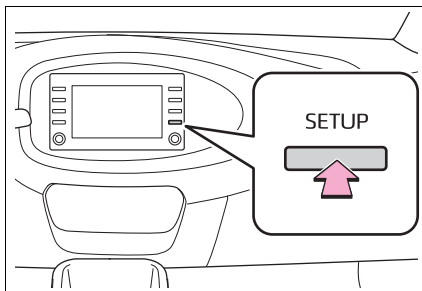

- If the general settings screen is not displayed, select "General".
- 2 Select "Customise home screen".
 - 3 Select the items to be set.

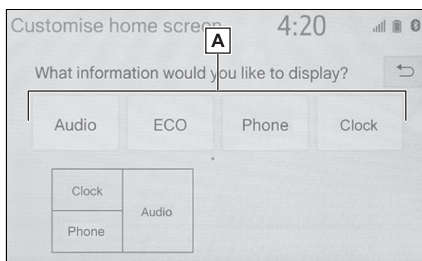

- A** Select to change the display information and area on the home screen.

Entering letters and numbers/list screen operation

Entering letters and numbers

When searching by an address, name, etc., or entering data, letters and numbers can be entered via the screen.

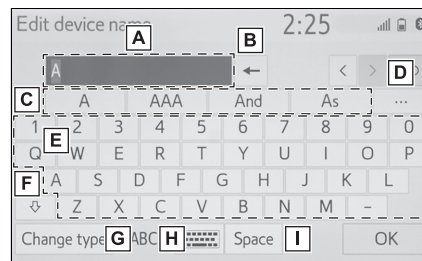

- A** Text field. Entered character(s) will be displayed.
- B** Select to erase one character. Select and hold to continue erasing characters.
- C** Select to choose a predictive text candidate for entered text.* (→P.23)
- D** Select to display a list of predictive text candidates when there is more than one.* (→P.23)
- E** Select to enter desired characters.
- F** Select to enter characters in lower case or in upper case.

- G** Select to change character types.
- H** Select to change character types and keyboard layout.
- I** Select to make a space on cursor.

*: These functions are not available in some languages.

- When  is displayed, selecting it will move the cursor within the text field.

Changing character type and keyboard layout

- 1 Select .

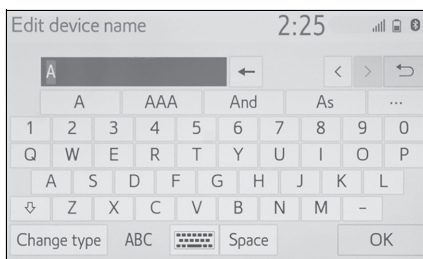

- 2 Select the desired character and keyboard and select "OK".

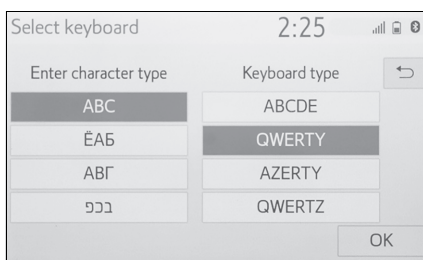

Changing character type

- 1 Select "Change type".

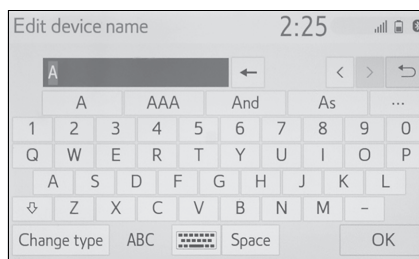

- 2 Select the desired character.

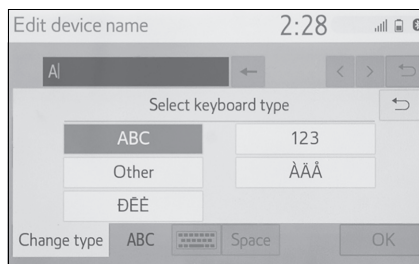

- Depending on the screen being displayed, it may not be possible to change keyboard characters.

Displaying predictive text candidates*

- *: These functions are not available in some languages.

When text is input, the system predicts the text that may complete the currently unconfirmed text and displays predictive replacement candidates that match the beginning of the text.

- 1 Input text.

2

Basic function

2 Select the desired candidate.

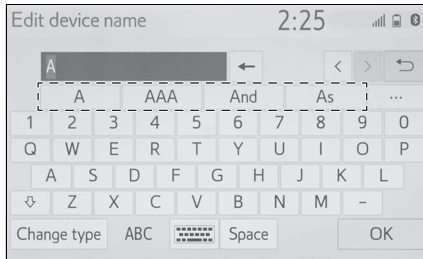

- To select a candidate that is not displayed, select **...**, and then select the desired predictive replacement candidate.

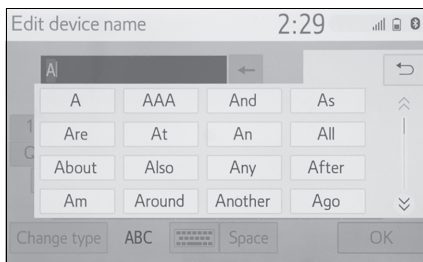

List screen

The list screen may be displayed after entering characters. When a list is displayed, use the appropriate screen button to scroll through the list.

Scrolling list screen

When a list is displayed, use the appropriate screen button to scroll through the list.

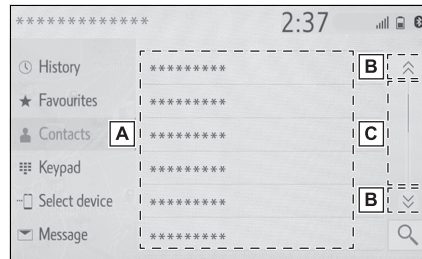

- A** To scroll up/down the list, flick the list up/down.
- B** Select to skip to the next or previous page. Select and hold to scroll through the displayed list.
- C** Indicates the position of the displayed entries in the entire list. To scroll up/down pages, drag the bar.

- If **>...** appears to the right of an item name, the complete name is too long to display.*1
- Select **>...** to scroll to the end of the name.
- Select **<...** to move to the beginning of the name.
- Matching items from the database are listed even if the entered address or name is incomplete.
- The list will be displayed automatically if the maximum number of characters is entered or matching items can be displayed on a single list screen.
- The number of matching items is shown on the right side of the screen. If the number of matching items is more than 999, the system displays asterisk marks on the screen.*2

*1: These functions are not available in some languages.

*2: If equipped

Searching a list

Items are displayed in the list with the most similar results of the search at the top.

- 1 Select .

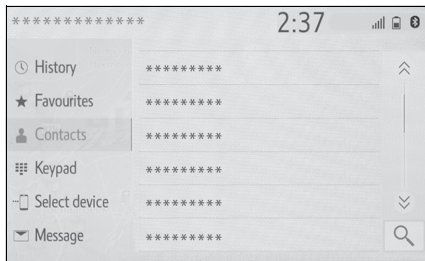

- 2 Input text.

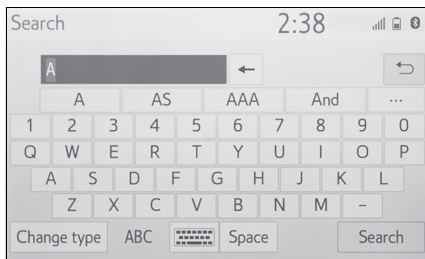

- 3 Select "Search".

- The list is displayed.

Screen adjustment

The contrast and brightness of the screen display and the image of the camera display can be adjusted. The screen can also be turned off, and/or changed to either day or night mode.

(For information regarding audio/visual screen adjustment: →P.59)

Displaying the screen adjustment screen

- 1 Press the "MENU" button.

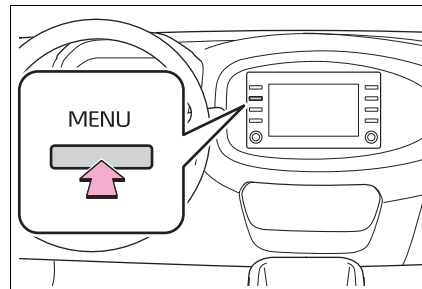

- 2 Select "Display".

- 3 Select the desired items to be set.

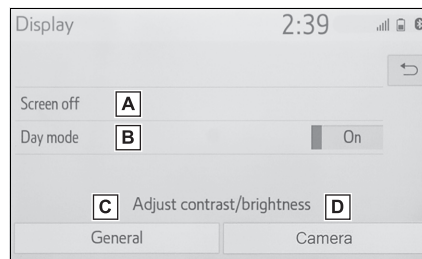

- A** Select to turn the screen off. To

2

Basic function

turn it on, press any button.

- B** Select to turn day mode on/off.

(→P.26)

- C** Select to adjust the screen display. (→P.26)

- D** Select to adjust the camera display. (→P.26)

- When the screen is viewed through polarized sunglasses, a rainbow pattern may appear on the screen due to optical characteristics of the screen. If this is disturbing, please operate the screen without polarized sunglasses.

Changing between day and night mode

Depending on the position of the headlight switch, the screen changes to day or night mode. This feature is available when the headlight is switched on.

- 1 Select "Day mode".

- If the screen is set to day mode with the headlight switch turned on, this condition is memorized even with the engine turned off.

Adjusting the contrast/brightness

The contrast and brightness of the screen can be adjusted according to the brightness of your surroundings.

- 1 Select "General" or "Camera".
- 2 Select the desired item.

- "Display (General)" screen only:
Select "<" or ">" to select the desired display.

- "Contrast"

"+": Select to strengthen the contrast of the screen.

"-": Select to weaken the contrast of the screen.

- "Brightness"

"+": Select to brighten the screen.

"-": Select to darken the screen.

Linking multi-information display and the system

The following functions of the system are linked with the multi-information display in the instrument cluster:

- Phone *
- Audio

etc.

These functions can be operated using multi-information display control switches on the steering wheel. For details, refer to “Owner’s Manual”.

*: When an Apple CarPlay connection is established, this function will be unavailable.

2

Basic function

Registering/Connecting a Bluetooth® device

To use the hands-free system, it is necessary to register a Bluetooth® phone with the system.

Once the phone has been registered, it is possible to use the hands-free system.

This operation cannot be performed while driving.

When an Apple CarPlay connection is established, Bluetooth® functions of the system will become unavailable and any connected Bluetooth® devices will be disconnected.

When connecting to Android Auto, a Bluetooth® connection will be made automatically.

When an Android Auto connection is established, some Bluetooth® functions other than hands-free system cannot be used.

Registering a Bluetooth® phone for the first time

■ Registering from the system

- 1 Turn the Bluetooth® connection setting of your cellular phone on.
 - This function is not available when Bluetooth® connection set-

ting of your cellular phone is set to off.

- 2 Press the "MENU" button.

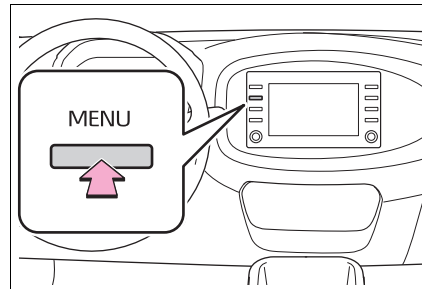

- 3 Select "Phone".
 - Operations up to this point can also be performed by pressing the "PHONE" button on the instrument panel.
- 4 Select "Yes" to register a phone.

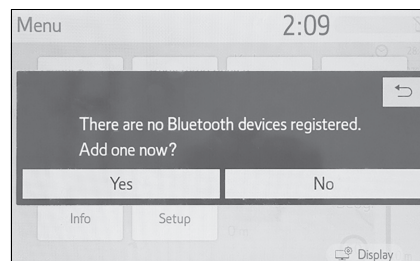

- 5 Select the desired Bluetooth® device.

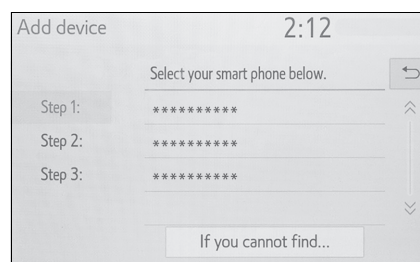

- If the desired Bluetooth® device is not on the list, select "If you

cannot find...” and follow the guidance on the screen to try again or register from the device. (→P.30)

6 Register the Bluetooth® device using your Bluetooth® device.

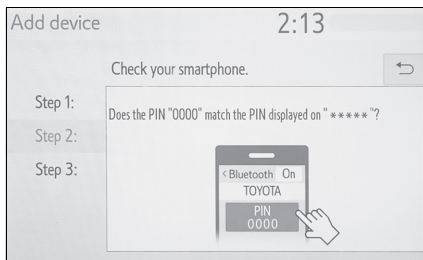

- For details about operating the Bluetooth® device, see the manual that comes with it.
- A PIN code is not required for SSP (Secure Simple Pairing) compatible Bluetooth® devices. Depending on the type of Bluetooth® device being connected, a message confirming registration may be displayed on the Bluetooth® device's screen. Respond and operate the Bluetooth® device according to the confirmation message.

7 Check that the following screen is displayed, indicating pairing was successful.

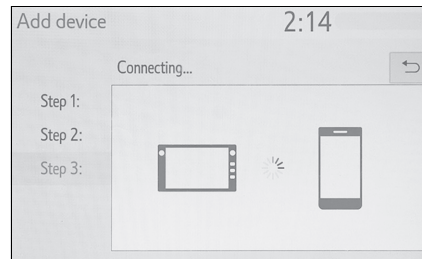

- The system is connecting to the registered device.
 - At this stage, the Bluetooth® functions are not yet available.
- 8** Check that “Connected” is displayed and registration is complete.

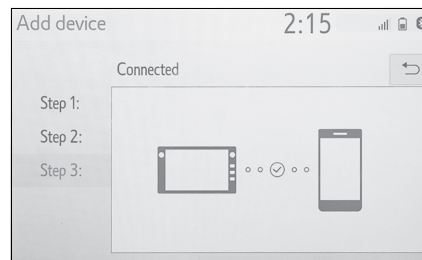

- If an error message is displayed, follow the guidance on the screen to try again.
- If a cellular phone does not operate properly after being connected, turn the cellular phone off and on and then connect it again.

2

Basic function

■ **Registering from phone**

1 Select “If you cannot find...”.

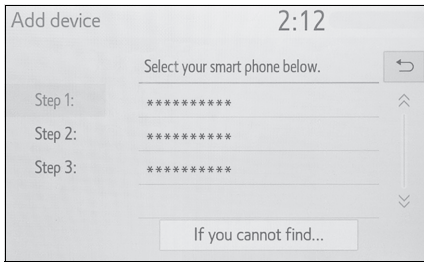

2 Select “Register from phone”.

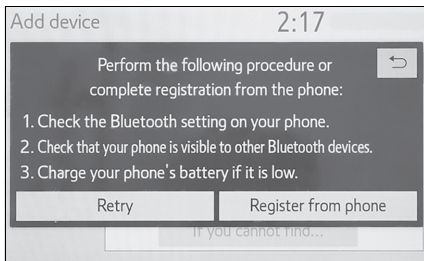

3 Check that the following screen is displayed, and register the Bluetooth® device using your Bluetooth® device.

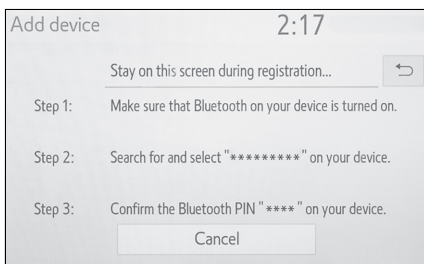

- For details about operating the Bluetooth® device, see the manual that comes with it.
- A PIN code is not required for SSP (Secure Simple Pairing) compatible Bluetooth® devices. Depending on the type of Blue-

tooth® device being connected, a message confirming registration may be displayed on the Bluetooth® device’s screen. Respond and operate the Bluetooth® device according to the confirmation message.

4 Follow the steps in “Registering a Bluetooth® phone for the first time” from step 7. (→P.28)

Registering a Bluetooth® audio player for the first time

To use the Bluetooth® audio, it is necessary to register an audio player with the system.

Once the player has been registered, it is possible to use the Bluetooth® audio.

This operation cannot be performed while driving.

For details about registering a Bluetooth® device: →P.34

- 1 Turn the Bluetooth® connection setting of your audio player on.
- This function is not available when the Bluetooth® connection setting of your audio player is set to off.

2 Press the “AUDIO” button.

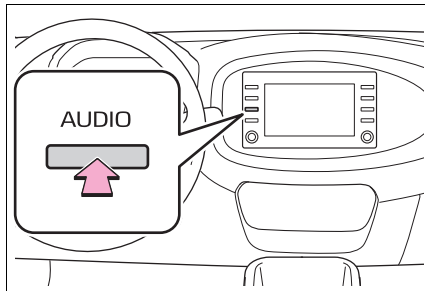

- 3** Select “Source” on the audio screen or press “AUDIO” button again.
- 4** Select “Bluetooth”.
- 5** Select “Yes” to register an audio player.
- 6** Follow the steps in “Registering a Bluetooth® phone for the first time” from step **5**. (→P.28)

Profiles

This system supports the following services.

■ **Bluetooth® Core Specification**

- Ver. 2.0 (Recommended: Ver. 4.2)
- **Profiles:**
 - HFP (Hands Free Profile) Ver. 1.0 (Recommended: Ver. 1.7)
 - This is a profile to allow hands-free phone calls using a cellular phone. It has outgoing and incoming call functions.
 - OPP (Object Push Profile) Ver. 1.1 (Recommended: Ver. 1.2)
 - This is a profile to transfer contacts

data.

- PBAP (Phone Book Access Profile) Ver. 1.0 (Recommended: Ver. 1.2)
 - This is a profile to transfer phone-book data.
- MAP (Message Access Profile) Ver. 1.0 (Recommended: Ver. 1.2)
 - This is a profile to use phone message functions.
- A2DP (Advanced Audio Distribution Profile) Ver. 1.0 (Recommended: Ver. 1.3)
 - This is a profile to transmit stereo audio or high quality sound to the audio/visual system.
- AVRCP (Audio/Video Remote Control Profile) Ver. 1.0 (Recommended: Ver. 1.6)
 - This is a profile to allow remote control the A/V equipment.

- This system is not guaranteed to operate with all Bluetooth® devices.
- If your cellular phone does not support HFP, registering the Bluetooth® phone or using OPP, PBAP or MAP profiles individually will not be possible.
- If the connected Bluetooth® device version is older than recommended or incompatible, the Bluetooth® device function may not work properly.
- Certification



Bluetooth is a registered trademark of Bluetooth SIG, Inc.

Setting Bluetooth® details

Displaying the Bluetooth® setup screen

- 1 Press the “SETUP” button.

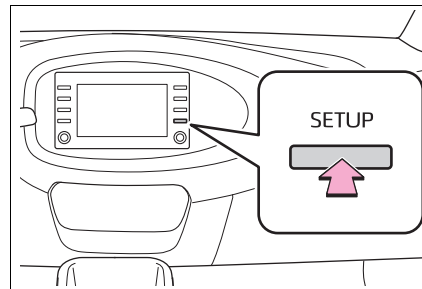

- 2 Select “Bluetooth”.
- 3 Select the desired item to be set.

Bluetooth® setup screen

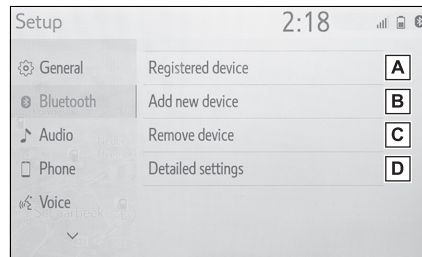

- A** Connecting a Bluetooth® device and editing the Bluetooth® device information (→P.33, 35)
- B** Registering a Bluetooth® device (→P.34)
- C** Deleting a Bluetooth® device

(→P.35)

D Setting the Bluetooth® system

(→P.37)

- When an Apple CarPlay connection is established, this function will be unavailable.
- When an Android Auto connection is established, some functions will be unavailable.

Connecting a Bluetooth® device

Up to 5 Bluetooth® devices (Phones (HFP) and audio players (AVP)) can be registered.

If more than 1 Bluetooth® device has been registered, select which device to connect to.

- 1 Display the Bluetooth® settings screen. (→P.32)
- 2 Select “Registered device”.
- 3 Select the device to be connected.

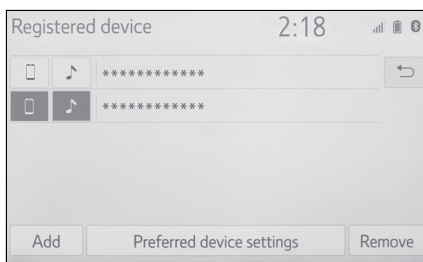

“Add”: Registering a Bluetooth® device (→P.34)

“Preferred device settings”: Select to change the automatic connection priority of the registered Bluetooth® devices. (→P.37)

“Remove”: Deleting a Bluetooth® device (→P.35)

: Phone

: Audio player

- The profile icon for a currently connected device will be displayed in colour.
- Selecting a profile icon which is not currently connected will switch the connection to the function.
- If the desired Bluetooth® device is not on the list, select “Add new device” to register the device. (→P.34)

4 Select the desired connection.

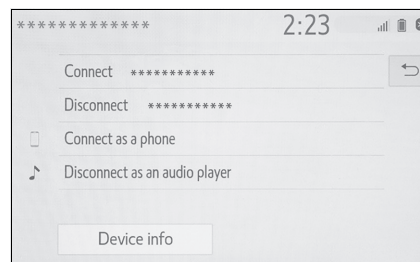

“Device info”: Select to confirm and change the Bluetooth® device information. (→P.35)

► When another Bluetooth® device is connected

- To disconnect the Bluetooth® device, select “Yes”.

5 Check that a confirmation screen is displayed when the connection is complete.

- If an error message is displayed, follow the guidance on the

screen to try again.

- It may take time if the device connection is carried out during Bluetooth® audio playback.
- Depending on the type of Bluetooth® device being connected, it may be necessary to perform additional steps on the device.
- When disconnecting a Bluetooth® device, it is recommended to disconnect using this system.

Connecting a Bluetooth® device in a different way (from phone top screen)

→P.108

Connecting a Bluetooth® device in a different way (from phone setup screen)

→P.122

Connecting a Bluetooth® device in a different way (from Bluetooth® audio screen)

→P.75

■ Auto connection mode

To turn auto connection mode on, set “Bluetooth power” to on. (→P.37) Leave the Bluetooth® device in a location where the connection can be established.

- When the engine switch is turned to ACC or ON, the system searches for a nearby registered

device.

- The system will connect with the registered device that was last connected, if it is nearby. When automatic connection priority is set to on and there is more than one registered Bluetooth® phone available, the system will automatically connect to the Bluetooth® phone with the highest priority. (→P.37)

■ Connecting manually

When the auto connection has failed or “Bluetooth power” is turned off, it is necessary to connect the Bluetooth® device manually.

- 1 Display the Bluetooth® settings screen. (→P.32)
- 2 Follow the steps in “Connecting a Bluetooth® device” from step 2. (→P.33)

■ Reconnecting the Bluetooth® phone

If a Bluetooth® phone is disconnected due to poor reception from the Bluetooth® network when the engine switch is in ACC or ON, the system automatically reconnects the Bluetooth® phone.

Registering a Bluetooth® device

Up to 5 Bluetooth® devices can be registered.

Bluetooth® compatible phones (HFP) and audio players (AVP) can be registered simultaneously.

This operation cannot be performed while driving.

- 1 Display the Bluetooth® settings screen. (→P.32)
- 2 Select “Add new device”.
 - ▶ When another Bluetooth® device is connected
 - To disconnect the Bluetooth® device, select “Yes”.
 - ▶ When 5 Bluetooth® devices have already been registered
 - A registered device needs to be replaced. Select “Yes”, and select the device to be replaced.
- 3 Follow the steps in “Registering a Bluetooth® phone for the first time” from step 5. (→P.28)

Deleting a Bluetooth® device

This operation cannot be performed while driving.

- 1 Display the Bluetooth® settings screen. (→P.32)
- 2 Select “Remove device”.

- 3 Select the desired device.

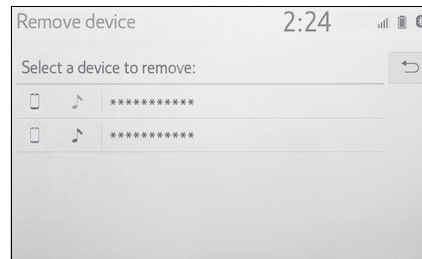

- 4 Select “Yes” when the confirmation screen appears.
- 5 Check that a confirmation screen is displayed when the operation is complete.

- When deleting a Bluetooth® phone, the contact data will be deleted at the same time.

Editing the Bluetooth® device information

The Bluetooth® device's information can be displayed on the screen. The displayed information can be edited.

This operation cannot be performed while driving.

- 1 Display the Bluetooth® settings screen. (→P.32)
- 2 Select “Registered device”.
- 3 Select the desired device to be edited.

4 Select "Device info".

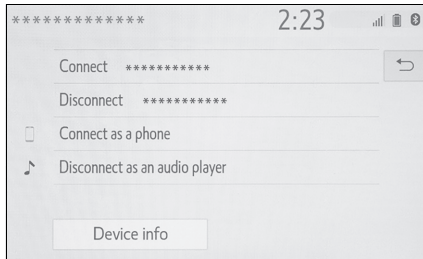

5 Confirm and change the Bluetooth® device information.

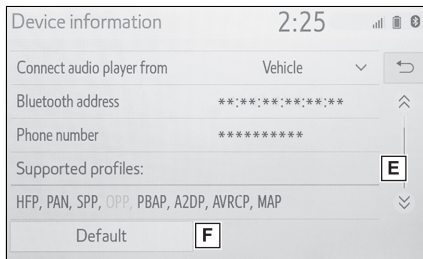
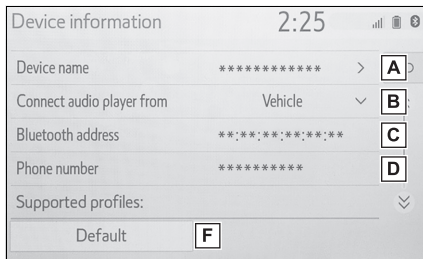

- A** The name of the Bluetooth® device. Can be changed to a desired name. (→P.36)
- B** Select to set the Bluetooth® audio player connection method. (→P.36)
- C** Device address is unique to the device and cannot be changed.
- D** Phone number of the Bluetooth®

phone.

- E** Compatibility profile of the Bluetooth® device.
- F** Select to reset all setup items.

- If 2 Bluetooth® devices have been registered with the same device name, the devices can be distinguished by referring to the device addresses.
- Depending on the type of phone, some information may not be displayed.

Changing a device name

- 1 Select "Device name".
- 2 Enter the name and select "OK".

- Even if the device name is changed, the name registered in your Bluetooth® device does not change.

Setting audio player connection method

- 1 Select "Connect audio player from".
- 2 Select the desired connection method.

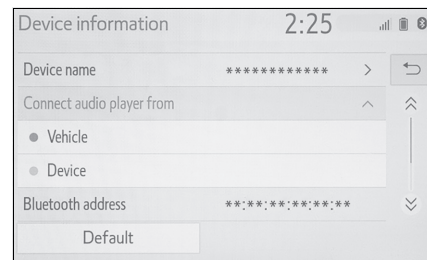

"Vehicle": Select to connect the audio player from the vehicle's audio/visual system.

“Device”: Select to connect the vehicle’s audio/visual system from the audio player.

- Depending on the audio player, the “Vehicle” or “Device” connection method may be best. As such, refer to the manual that comes with the audio player.

“Detailed settings” screen

The Bluetooth® settings can be confirmed and changed.

- 1 Display the Bluetooth® settings screen. (→P.32)
- 2 Select “Detailed settings”.
- 3 Select the desired item to be set.

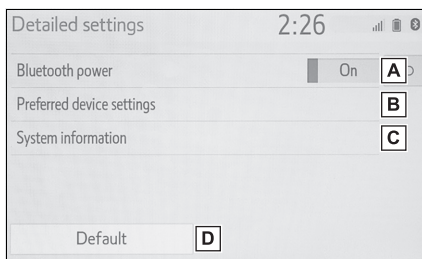

- A** Select to set Bluetooth® connection on/off. (→P.37)
- B** Select to change the automatic connection priority of the registered Bluetooth® devices. (→P.37)
- C** Select to edit the system information. (→P.38)
- D** Select to reset all setup items.

Changing “Bluetooth power”

- 1 Select “Bluetooth power”.

When “Bluetooth power” is on:

The Bluetooth® device is automatically connected when the engine switch is turned to ACC or ON.

When “Bluetooth power” is off:

The Bluetooth® device is disconnected, and the system will not connect to it next time.

- While driving, the auto connection state can be changed from off to on, but cannot be changed from on to off.

Setting automatic connection priority

The automatic connection priority of the registered Bluetooth® devices can be changed.

- 1 Select “Preferred device settings”.
- 2 Select the desired item to be set.

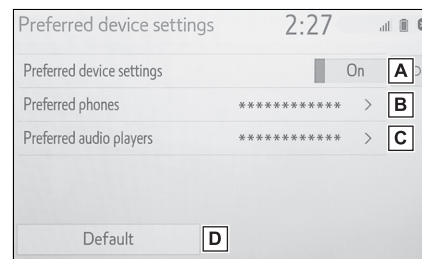

- A** Select to set automatic connection priority on/off.
- B** Select to change the automatic

2

Basic function

connection priority of the registered Bluetooth® phones.
(→P.38)

C Select to change the automatic connection priority of the registered Bluetooth® audio players.
(→P.38)

D Select to reset all setup items.

■ Changing Bluetooth® device automatic connection priority

1 Select “Preferred phones” or “Preferred audio players”.

2 Select the desired Bluetooth® device and select “Move up” or “Move down” to change the preferred order.

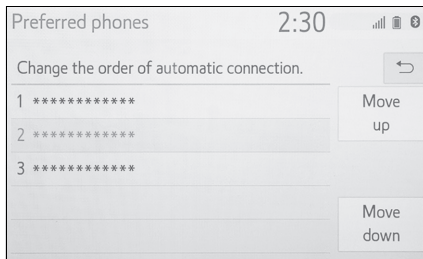

● A newly registered Bluetooth® device will automatically be given the highest automatic connection priority.

Editing the system information

1 Select “System information”.

2 Select the desired item to be set.

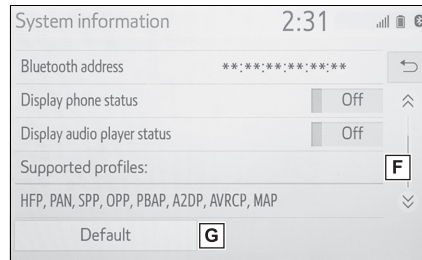
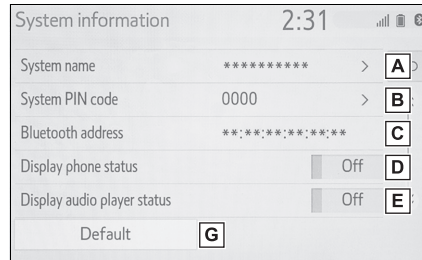

A Displays system name. Can be changed to a desired name.
(→P.39)

B PIN code used when the Bluetooth® device was registered. Can be changed to a desired code. (→P.39)

C Device address is unique to the device and cannot be changed.

D Select to set the connection status display of the phone on/off.

E Select to set the connection status display of the audio player on/off.

F Compatibility profile of the system

G Select to reset all setup items.

■ Editing the system name

- 1 Select "System name".
- 2 Enter a name and select "OK".

■ Editing the PIN code

- 1 Select "System PIN code".
- 2 Enter a PIN code and select "OK".

Connecting to Miracast[®] via Wi-Fi[®]

Using the Wi-Fi[®] function, this system can connect to Miracast[®]. But this function is not for connecting to internet. It's only for connecting to Miracast[®].

2

Basic function

Displaying the Wi-Fi[®] settings screen

- 1 Press the "SETUP" button.

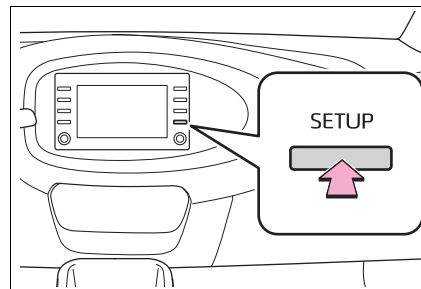

- 2 Select "Wi-Fi".
- 3 Select the items to be set.

Wi-Fi[®] settings screen

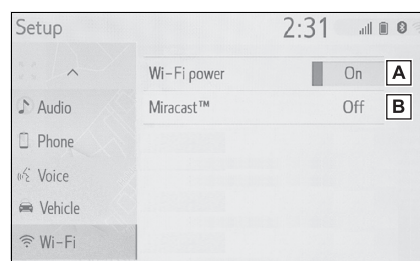

- A** Select to turn the Wi-Fi[®] func-

tion on/off. (→P.40)

B Displays status of the Miracast® connection.*

“On”: Connecting

“Off”: Not connecting

*: Miracast® status should be displayed only for Miracast® supported models.

Turning Wi-Fi® function on/off

When turned on, “Available networks” and “Easy setup” can be selected.

- 1 Display the Wi-Fi® settings screen. (→P.39)
- 2 Select “Wi-Fi power”.
 - Each time “Wi-Fi power” is selected, the Wi-Fi® function is turned on/off.

Wi-Fi® function operating hints

- Wi-Fi® is a registered trademark of Wi-Fi Alliance®.
- If the vehicle is near a radio antenna, radio station or other source of strong radio waves and electrical noise, communication may be slow or impossible.

WARNING

- Use Wi-Fi® devices only when safe and legal to do so.
- Your audio unit is fitted with Wi-Fi® antennas. People with implantable cardiac pacemakers, cardiac resynchronization therapy-pacemakers or implantable cardioverter defibrillators should maintain a reasonable distance between themselves and the Wi-Fi® antennas. The radio waves may affect the operation of such devices.
- Before using Wi-Fi® devices, users of any electrical medical device other than implantable cardiac pacemakers, cardiac resynchronization therapy-pacemakers or implantable cardioverter defibrillators should consult the manufacturer of the device for information about its operation under the influence of radio waves. Radio waves could have unexpected effects on the operation of such medical devices.

Conditions displayed with Wi-Fi® icon

Reception level appears on the right upper side of the screen. (→P.14)

Specifications

- Communication standards
 - IEEE 802.11b
 - IEEE 802.11g
 - IEEE 802.11n (2.4GHz)
- Security
 - WPA™
 - WPA2™
- WPA™, WPA2™ are trademarks of Wi-Fi Alliance®.

2

Basic function

Apple CarPlay/Android Auto*

*: This function is not made available in some countries or areas

Apple CarPlay/Android Auto allows some applications, such as Map, Phone, and Music, to be used on the system.

When an Apple CarPlay/Android Auto connection is established, Apple CarPlay/Android Auto compatible applications will be displayed on the system display.

- **Compatible devices**

Apple iPhone (iOS Ver. 10.3 or later) that supports Apple CarPlay.

For details, refer to <https://www.apple.com/ios/carplay/>.

Android devices which support Android Auto and have the Android Auto application installed.

For details, refer to <https://www.android.com/auto/>.

Establishing an Apple CarPlay connection

- 1 Enable Siri on the device to be connected.
- 2 Connect the device to the USB port. (→P.58)

- 3 Select “Always enable” or “Enable once”.
 - If “Do not enable” is selected, an Apple CarPlay connection will not be established. In this case, the device can be operated as a normal Apple device, such as an iPod. Apple CarPlay will remain disabled until “Preferred service” on the general settings screen is set to “Apple CarPlay”. (→P.49)
 - Depending on the device connected, it may take approximately 3 to 6 seconds before the system returns to previous screen.
 - The screen may change to step 6 depending on the system.
- 4 Press the “MENU” button.

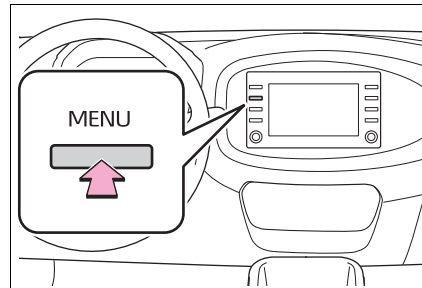

- 5 Select the “Apple CarPlay”.

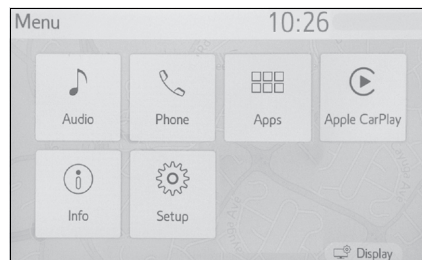

- 6** Check that home screen of Apple CarPlay is displayed.

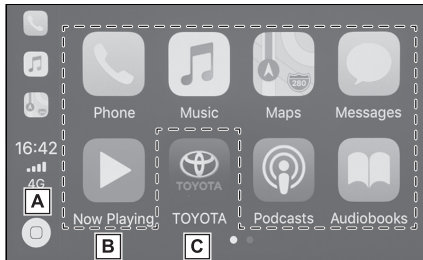

- A** Select to display the home screen of Apple CarPlay. Select and hold to activate Siri.
- B** Select to start the application. User can use any iPhone application supported by Apple CarPlay.
- C** Select to display the system screen.

Establishing an Android Auto connection

- 1** Check that the Android Auto application is installed to the device to be connected.
- 2** Connect the device to the USB port. (→P.58)

- 3** Select “On” to enable the function.



- “Off”: To enable Android Auto, set “Preferred service” on the general settings screen to “Android Auto”. (→P.49)
 - Depending on the device connected, it may take approximately 3 to 6 seconds before the system returns to previous screen.
 - The screen may change to step **6** depending on the system.
- 4** Press the “MENU” button.

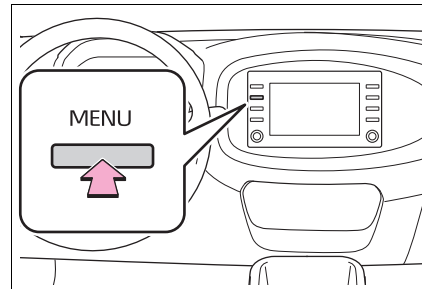

2

Basic function

5 Select the “Android Auto”.

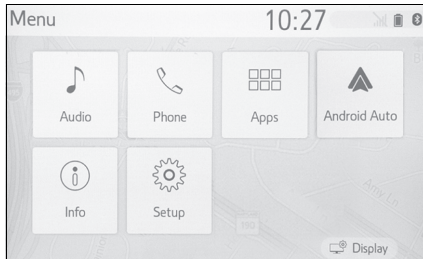

6 Check that home screen of Android Auto is displayed.

- When an Apple CarPlay/Android Auto connection is established, the function of some system buttons will change.
- When an Apple CarPlay/Android Auto connection is established, some system functions, such as the following, will be replaced by similar Apple CarPlay/Android Auto functions or will become unavailable:
 - iPod (Audio Playback)
 - USB audio/USB video
 - Bluetooth® audio
 - Bluetooth® phone (Apple CarPlay only)
- When an Android Auto connection is established while using Miracast®, Miracast® may become unavailable.
- The guidance volume can be changed on the voice settings screen. (→P.52) It cannot be changed by “POWER VOLUME” knob on Audio control panel.
- Apple CarPlay/Android Auto is an application developed by Apple Inc/Google LLC. Its functions and services may be terminated or changed without notice depending on the connected device’s operation system, hardware and software, or due to changes in Apple CarPlay/Android Auto specifications.
- For a list of the apps supported by Apple CarPlay or Android Auto, refer to their respective website.

- While using these functions, vehicle and user information, such as location and vehicle speed, will be shared with the respective application publisher and the cellular service provider.
- By downloading and using each application, you agree to their terms of use.
- Data for these functions is transmitted using the internet and may incur charges. For information about data transmission fees, contact your cellular service provider.
- Depending on the application, certain functions, such as music playback, may be restricted.
- As the applications for each function are provided by a third-party, they may be subject to change or discontinuation without notice. For details, refer to the website of the function.
- If the vehicle’s navigation system is being used for route guidance and a route is set using the Apple CarPlay/Android Auto Maps app, route guidance will be performed through Apple CarPlay/Android Auto. If the Apple CarPlay/Android Auto Maps app is being used for route guidance and a route is set using the vehicle’s navigation system, route guidance will be performed by the vehicle’s navigation system.
- If the USB cable is disconnected, operation of Apple CarPlay/Android Auto will end. At this time, sound output will stop and change to the system screen.



- Use of the Apple CarPlay logo means that a vehicle user interface meets Apple performance standards. Apple is not responsible for the operation of

this vehicle or its compliance with safety and regulatory standards. Please note that the use of this accessory with an Apple product may affect wireless performance.

- Apple CarPlay is a trademark of Apple Inc.

2

Basic function

androidauto

- Android™ and Android Auto™ are trademarks of Google LLC.



WARNING

- Do not connect smartphone or operate the controls while driving.



NOTICE

- Do not leave your smartphone in the vehicle. In particular, high temperatures inside the vehicle may damage the smartphone.
- Do not push down on or apply unnecessary pressure to the smartphone while it is connected as this may damage the smartphone or its terminal.
- Do not insert foreign objects into the port as this may damage the smartphone or its terminal.

Troubleshooting

If you are experiencing difficulties with Apple CarPlay/Android Auto, check the following table.

Symptom	Solution
An Apple CarPlay/Android Auto connection cannot be established.	<p>Check if the device supports Apple CarPlay/Android Auto.</p> <p>Check if Apple CarPlay/Android Auto is enabled on the connected device.</p> <p>Check if that the Android Auto application is installed to the device to be connected.</p> <p>For details, refer to Apple CarPlay: https://www.apple.com/ios/carplay/. Android Auto: https://www.android.com/auto/.</p> <p>For available countries or areas for Apple CarPlay, refer to https://www.apple.com/ios/feature-availability/#apple-carplay.</p>
	<p>Check if “Apple CarPlay”/“Android Auto” of “Preferred service” on the general settings screen is set to on. (→P.49)</p>
	<p>Check if the USB cable being used is securely connected to the device and USB port.</p> <p>Try connecting the smartphone directly to the USB port in the vehicle, without using the hub.</p> <p>For Apple CarPlay: Check if the Lightning cable being used is certified by Apple and check if Siri is enabled.</p> <p>Replace the USB cable with another cable. (A short USB cable is recommended)</p> <p>After checking all of the above, try to establish an Apple CarPlay/Android Auto connection. (→P.42)</p>
When an Apple CarPlay/Android Auto connection is established and a video is being played, the video is not displayed, but audio is output through the system.	<p>As the system is not designed to play video through Apple CarPlay/Android Auto, this is not a malfunction.</p>

Symptom	Solution
Although an Apple CarPlay/Android Auto connection is established, audio is not output through the system.	The system may be muted or the volume may be low. Increase the system volume.
The Apple CarPlay/Android Auto screen has artifacts and/or audio from Apple CarPlay/Android Auto has noise.	Check if the USB cable being used to connect the device to the system is damaged. To check if the USB cable is damaged internally, connect the device to another system, such as a PC, and check if the device is recognized by the connected system. (The device should begin charging when connected.)
	Replace the USB cable with another cable. (A short USB cable is recommended)
	After checking all of the above, try to establish an Apple CarPlay/Android Auto connection. (→P.42)
The map display of the Apple CarPlay Maps app cannot be enlarged or contracted with pinch multi-touch gestures.	As the Apple CarPlay Maps app is not compatible with pinch multi-touch gestures, this is not a malfunction.
During Apple CarPlay music application (Apple Music, Spotify, etc.) playback, if the iPhone is operated to start and play audio from an application that is not compatible with Apple CarPlay* and the onboard device volume is changed, the audio of the incompatible application stops and the system resumes playback of the original music application.	This operation is performed according to the specification of the onboard device, this is not a malfunction.

Symptom	Solution
After interrupt audio (such as navigation route guidance) is played from an application that is not compatible with Apple CarPlay while the onboard device is playing audio (FM, DAB, etc.), the system does not resume playback of the original audio (FM, DAB, etc.).	This operation is performed according to the specification of the onboard device, this is not a malfunction. Manually change the audio source by yourself. Or, do not use applications that are not compatible with Apple CarPlay.* Due to some navigation applications are compatible from iOS 12, update to the latest iOS and application versions.
When using Apple CarPlay, route guidance arrows and turn by turn navigation are not displayed on the multi-information display and system display. When using Android Auto, turn by turn navigation is not displayed on the multi-information display and system display.	This is not a malfunction as display of these items is not possible with this function.
When using Android Auto, hands-free call audio cannot be heard from the vehicle's speakers.	Disconnect the phone from the USB cable and check if hands-free call audio can be heard using the hands-free system.
	Connect the phone to the system using Android Auto, turn up the volume on the system and check if hands-free call audio can be heard. Check if other sounds can be heard from the vehicle's speakers.

*: Applications not compatible with Apple CarPlay are applications installed on the iPhone that are not displayed on the Apple CarPlay screen application list. (such as visual voicemail)

General settings

Settings are available for clock, operation sounds, etc.

Displaying the general settings screen

- 1 Press the "SETUP" button.

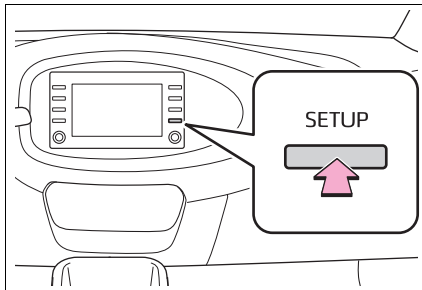

- If the general settings screen is not displayed, select "General".
- 2 Select the desired items to be set.

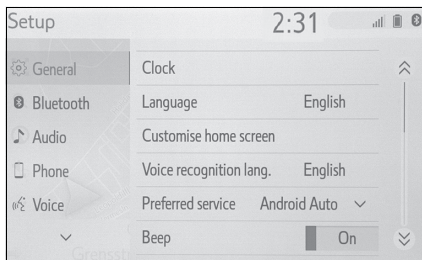

General settings screen

- "Clock"

Select to change the time zone and select "On" or "Off" for daylight saving time, automatic adjustment of the clock, etc. (→P.50)

- "Language"

Select to change the language. The language settings of Apple CarPlay/Android Auto can only be changed on the connected device.

- "Customise home screen"

Select to customize the home screen. (→P.21)

- "Voice recognition lang."

Select to change the voice recognition language.

- "Preferred service"

Select to choose the service to launch when the smartphone is connected. (→P.51)

- "Beep"

Select to turn the beep sound on/off.

- "Theme setting"

Select to change the screen theme settings.

- "Units of measurement"

Select to change the unit of measure for distance/fuel consumption.

- "Delete keyboard history"

Select to delete the keyboard history.

- "Memorise keyboard history"

Select to set the memorize keyboard history on/off.

- "Animation"

Select to set the animations on/off.

- "Delete personal data"

Select to delete personal data. (→P.51)

- "Software update"

Select to update software versions. For details, contact any Toyota retailer or Toyota authorized repairer, or any reliable repairer.

- "Software information"

Select to display the software information. Notices related to third party software used in this product are enlisted. (This includes instructions for obtaining such software, where applicable.)

Clock settings

- 1 Display the general settings screen. (→P.49)
- 2 Select “Clock”.
- 3 Select the desired items to be set.



- A** Select to change the time zone. (→P.50)
- B** Select to set daylight saving time on/off.
- C** Select to set automatic adjustment of the clock by GPS on/off. * When set to off, the clock can be manually adjusted. (→P.50)
- D** Select to set the 24 hour time format on/off. When set to off, the clock is displayed in 12 hour time format.

*: This item may not be displayed when the vehicle is not receiving GPS sig-

nals.

Time zone

- 1 Select “Time zone”.
- 2 Select the desired time zone.
 - If “Other” is selected, the zone can be adjusted manually. Select “+” or “-” to adjust the time zone.

Manual clock setting

When “Auto adjust by GPS” is turned off, the clock can be manually adjusted.

- 1 Select “Auto adjust by GPS” to set to off.
- 2 Adjust the clock manually.

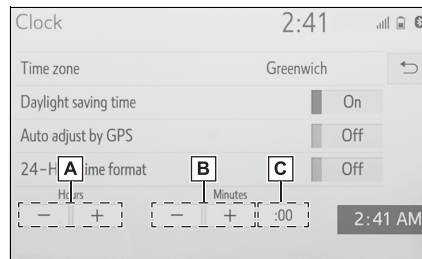

- A** Select “+” to set the time forward one hour and “-” to set the time back one hour.
- B** Select “+” to set the time forward one minute and “-” to set the time back one minute.
- C** Select to round to the nearest hour.

e.g.

1:00 to 1:29 → 1:00

1:30 to 1:59 → 2:00

- Phone settings

etc.

Preferred service settings

- 1 Display the general settings screen. (→P.49)
- 2 Select “Preferred service”.
- 3 Select the desired items to be set.

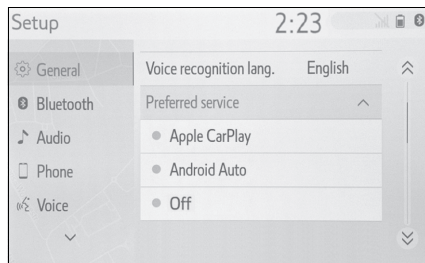

- This setting cannot be changed when a device is connected to the system via USB. Disconnect the device before attempting to change the setting.

Deleting personal data

Registered or changed personal settings will be deleted or returned to their default conditions.

- 1 Display the general settings screen. (→P.49)
- 2 Select “Delete personal data”.
- 3 Select “Delete”.
- 4 Select “Yes” when the confirmation screen appears.

Examples of settings that can be returned to their default conditions:

- Navigation settings
- Audio settings

2

Basic function

Voice settings

Voice volume, etc. can be set.

Displaying the voice settings screen

- 1 Press the "SETUP" button.

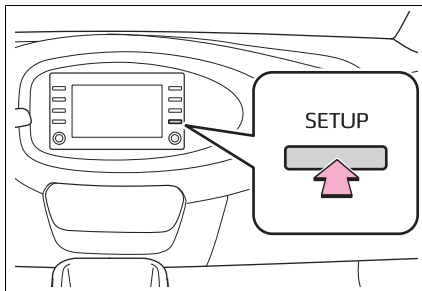

- 2 Select "Voice".
- 3 Select the desired items to be set.

Voice settings screen

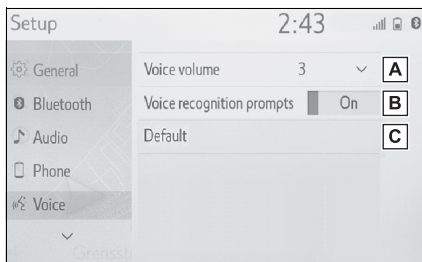

- A** Select to adjust the volume of voice guidance.*
- B** Select to set the voice recognition prompts on/off.
- C** Select to reset all setup items.

*: When an Apple CarPlay/Android

Auto connection is established, speech command system (Siri/Google Assistant) and map application voice guidance volume can be changed.

Vehicle settings

Settings are available for vehicle customisation and valet mode.

Displaying the vehicle settings screen

- 1 Press the "SETUP" button.

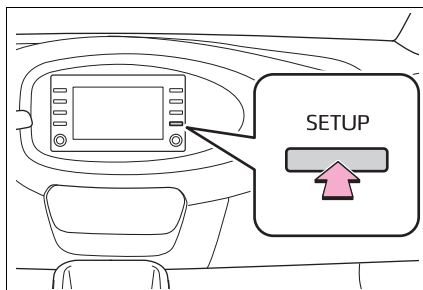

- 2 Select "Vehicle".
- 3 Select the desired items to be set.

Vehicle settings screen

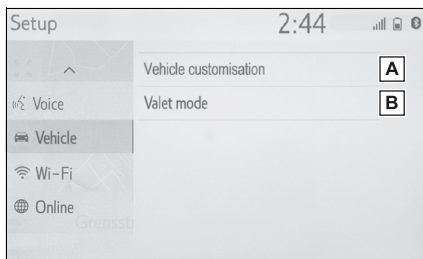

A Select to set vehicle customisation.*

B Select to set valet mode.

(→P.53)

*: Refer to the "Owner's Manual".

Setting the valet mode

The security system can be set to on by entering a security code (4-digit number).

When set to on, the system will become inoperative once the electrical power source is disconnected until the security code is entered.

Setting the valet mode

- 1 Display the vehicle settings screen. (→P.53)
- 2 Select "Valet mode".
- 3 Enter the 4-digit personal code and select "OK".
- 4 Enter the same 4-digit personal code again and select "OK".

- The system will request that you input the security code again to confirm that you remember it correctly.
- When valet mode activates, the system stops and a security code (4-digit number) standby screen is displayed. (→P.53)

- If the 4-digit personal code is forgotten, please contact any Toyota retailer or Toyota authorized repairer, or any reliable repairer.

If the valet mode has been activated

- 1 Enter the 4-digit personal code and select "OK".

- If an incorrect security code (4-digit number) is entered 6 times, the system will not accept another security code (4-digit number) for 10 minutes.

Audio/visual system**3**

3-1. Basic operation	
Quick reference	56
Some basics	57
3-2. Radio operation	
FM/DAB radio	62
3-3. Media operation	
USB memory	67
iPod/iPhone (Apple CarPlay)	69
Android Auto	72
Bluetooth® audio.....	73
Miracast®	76
3-4. Audio/visual remote controls	
Steering switches	79
3-5. Setup	
Audio settings	80
3-6. Tips for operating the audio/visual system	
Operating information	81

For vehicles sold outside Europe, some of the functions cannot be operated while driving.

Quick reference

Functional overview

The audio control screen can be reached by the following methods:

- ▶ From the “AUDIO” button
 - 1 Press the “AUDIO” button.
- ▶ From the “MENU” button
 - 1 Press the “MENU” button, then select “Audio”.

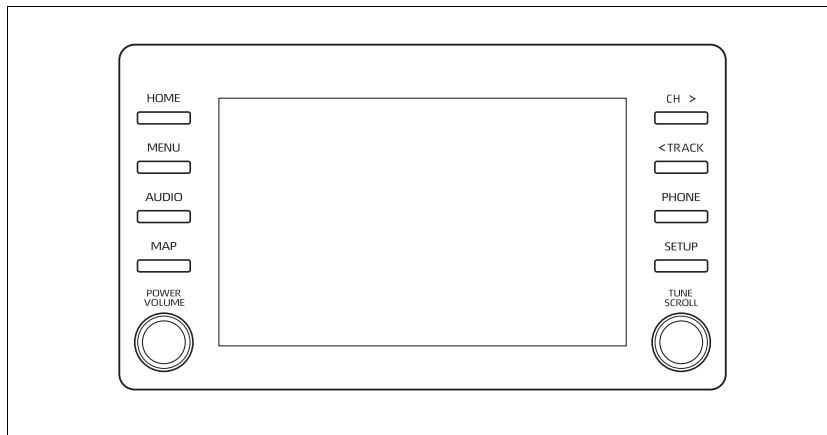

- Using the radio (→P.62)
- Playing a USB memory (→P.67)
- Playing an iPod/iPhone (Apple CarPlay*) (→P.69)
- Using the Android Auto* (→P.72)
- Playing a Bluetooth® device (→P.73)
- Using the Miracast® (→P.76)
- Using the steering wheel audio switches (→P.79)
- Audio system settings (→P.80)

* : This function is not made available in some countries or areas.

Some basics

This section describes some of the basic features of the audio/visual system. Some information may not pertain to your system.

Your audio/visual system works when the engine switch is in ACC or ON.



NOTICE

- To prevent the 12-volt battery from being discharged, do not leave the audio/visual system on longer than necessary when the engine is not running.

Turning the system on and off

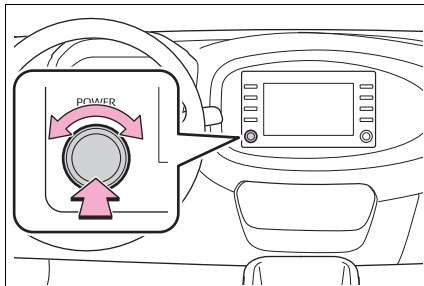

“POWER VOLUME” knob: Press to turn the audio/visual system on and off. The system turns on in the last mode used. Turn this knob to adjust the volume.

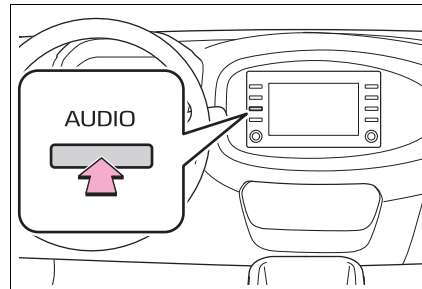

Selecting an audio source

- 1 Press the “AUDIO” button.

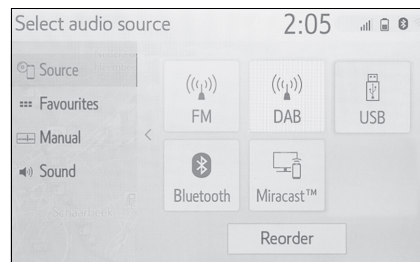

- 2 Select “Source” or press “AUDIO” button again.
- 3 Select the desired source.



- Dimmed screen buttons cannot be operated.
- When there are two pages, select  or  to change the page.
- When an Apple CarPlay/Android Auto connection is established, some system functions, such as the following, will be replaced by similar Apple CarPlay/Android Auto function or will become unavailable:
 - iPod (Audio Playback)
 - USB audio/USB video
 - Bluetooth® audio

Reordering the audio source

- 1 Display the audio source selection screen. (→P.57)
- 2 Select “Reorder”.
- 3 Select the desired audio source then **<** or **>** to reorder.

USB port (Type A)*

*: If equipped

- 1 Connect a device to the USB port.

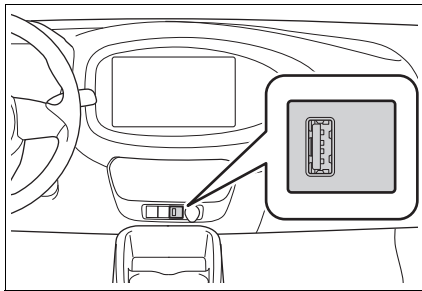

- Turn on the power of the device if it is not turned on.
- If a USB hub is plugged-in, two devices can be connected at a time.
- Even if a USB hub is used to connect more than two USB devices, only the first two connected devices will be recognized.
- If a USB hub that has more than two ports is connected to the USB port, devices connected to the USB hub may not charge or be operable, as the supply of current may be insufficient.

Sound settings

- 1 Display the audio control screen. (→P.56)
- 2 Select “Sound”.
- 3 Select the desired item to be set.

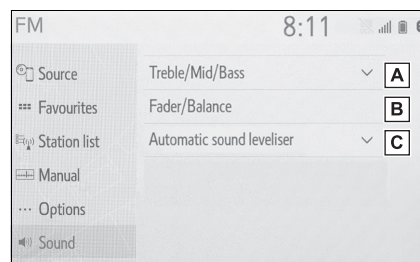

- A** Select to set the treble/mid/bass. (→P.58)
- B** Select to set the fader/balance. (→P.59)
- C** Select to set the automatic sound leveliser. (→P.59)

■ Treble/Mid/Bass

How good an audio program sounds is largely determined by the mix of the treble, mid and bass levels. In fact, different kinds of music and vocal programs usually sound better with different mixes of treble, mid and bass.

- 1 Select “Treble/Mid/Bass”.

2 Select the desired screen button.

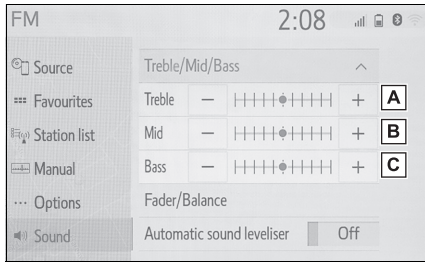

- A** Select “+” or “-” to adjust high-pitched tones.
- B** Select “+” or “-” to adjust mid-pitched tones.
- C** Select “+” or “-” to adjust low-pitched tones.

■ **Fader/Balance**

A good balance of the left and right stereo channels and of the front and rear sound levels is also important.

Keep in mind that when listening to a stereo recording or broadcast, changing the right/left balance will increase the volume of 1 group of sounds while decreasing the volume of another.

1 Select “Fader/Balance”.

2 Select the desired screen button.

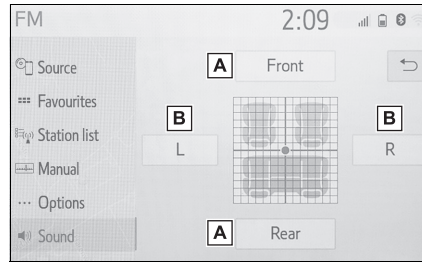

- A** Select to adjust the sound balance between the front speaker and rear subwoofer*.
- B** Select to adjust the sound balance between the left and right speakers.

*: Rear subwoofer is applicable only JBL system.

■ **Automatic sound leveliser (ASL)**

The system adjusts to the optimum volume and tone quality according to vehicle speed to compensate for increased road noise, wind noise, or other noises while driving.

- 1** Select “Automatic sound leveliser”.
- 2** Select “High”, “Mid”, “Low” or “Off”.

Audio screen adjustment

■ **Screen format settings**

The screen adjustment can be selected for USB video and Miracast®.

3 Audio/visual system

- ▶ From the audio settings screen
- 1 Press the “SETUP” button.
- 2 Select “Audio”.
- 3 Select “Common”.
- 4 Select “Screen format”.
- 5 Select the desired item to be adjusted.

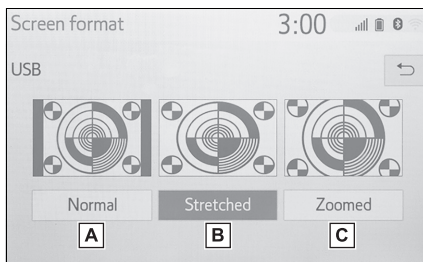

- A** Select to display a 4 : 3 screen, with either side in black.
- B** Select to enlarge the image horizontally and vertically to full screen.
- C** Select to enlarge the image by the same ratio horizontally and vertically.*

*: USB video only

- ▶ From the Miracast® control screen
- 1 Display the Miracast® control screen. (→P.76)
- 2 Select “Wide”.
- 3 Follow the steps in “From the audio settings screen” from step 5. (→P.59)

■ **Colour, tone, contrast and brightness adjustment**

The colour, tone, contrast and brightness of the screen can be adjusted.

- ▶ From the audio settings screen
- 1 Press the “SETUP” button.
- 2 Select “Audio”.
- 3 Select “Common”.
- 4 Select “Display”.
- 5 Select the desired item to be adjusted.

- “Colour”
 - “R”: Select to strengthen the red colour of the screen.
 - “G”: Select to strengthen the green colour of the screen.
- “Tone”
 - “+”: Select to strengthen the tone of the screen.
 - “-”: Select to weaken the tone of the screen.
- “Contrast”
 - “+”: Select to strengthen the contrast of the screen.
 - “-”: Select to weaken the contrast of the screen.
- “Brightness”
 - “+”: Select to brighten the screen.
 - “-”: Select to darken the screen.

● Depending on the audio source, some functions may not be available.

- ▶ From the Miracast® control screen
- 1 Display the Miracast® control screen. (→P.76)
- 2 Select “Display”.

- 3 Follow the steps in “From the audio settings screen” from step 5. (→P.60)

Speech command system

- 1 Press this switch to operate the speech command system.

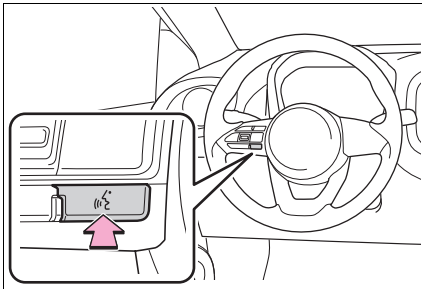

- The speech command system and its list of commands can be operated. (→P.90)

FM/DAB* radio

*: If equipped

Overview

The radio control screen can be reached by the following methods:
→P.57

Control screen

► FM

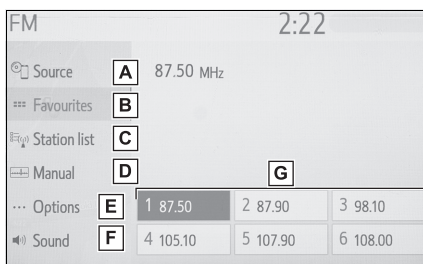

- A** Select to display the audio source selection screen.
- B** Select to display the favourites screen. (→P.63)
- C** Select to display a list of receivable stations.
- D** Select to display the manual tuning screen. (→P.64)
- E** Select to display the radio options screen. (→P.64)
- F** Select to display the sound setting screen. (→P.58)
- G** Select to tune to preset stations. (→P.63)

► DAB

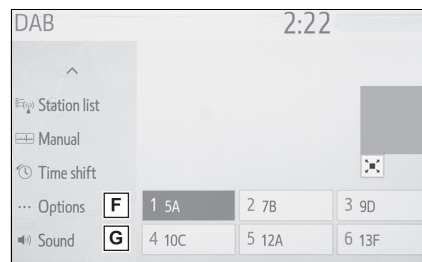
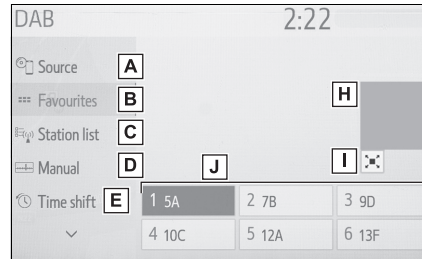

- A** Select to display the audio source selection screen.
- B** Select to display the favourites screen. (→P.63)
- C** Select to display a list of receivable service/station.
- D** Select to display the manual tuning screen. (→P.64)
- E** Select to display the time shift control screen. (→P.65)
- F** Select to display the radio options screen. (→P.64)
- G** Select to display the sound setting screen. (→P.58)
- H** Displays the slideshow images. The slideshow is available depending on the service.

- I** Select to switch to the expanded slideshow. To return to the previous screen, touch the button again.
- J** Select to tune to preset service/station. (→P.63)

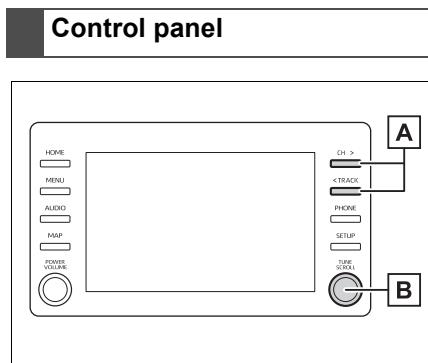

- A** FM:
 - Favourites screen: Press to select preset stations.
 - Station list screen: Press to move up/down the station.
 - Manual screen: Press to seek for stations. Press and hold for continuous seek.
 - DAB:
 - Favourites screen: Press to select preset services/stations.
 - Service/station list screen: Press to move up/down the service/station.
 - Manual screen: Press to seek for service/station. Press and hold for continuous seek.

- B** FM:

Favourites screen: Turn to select preset stations.
 Station list screen: Turn to move up/down the station.
 Manual screen: Turn to seek for frequencies.
 DAB:

- Favourites screen: Turn to select preset services/stations.
- Service/station list screen: Turn to move up/down the service/station.
- Manual screen: Turn to seek for service.
- DAB time shift screen: Turn to jump forward/backwards.

- The radio automatically changes to stereo reception when a stereo broadcast is received.
- If the signal becomes weak, the radio reduces the amount of channel separation to prevent the weak signal from creating noise. If the signal becomes extremely weak, the radio switches from stereo to mono reception.

Presetting a station

Up to 6 preset stations/services can be registered in FM mode and DAB mode.

- 1 Tune in the desired station.

- 2 Select one of the screen buttons (1-6) and hold it until a beep is heard.



- The station's frequency will be displayed in the screen button.
- To change the preset stations/services to a different one, follow the same procedure.

Manual tuning

► FM

- 1 Select "Manual".
- 2 Tune the desired station.

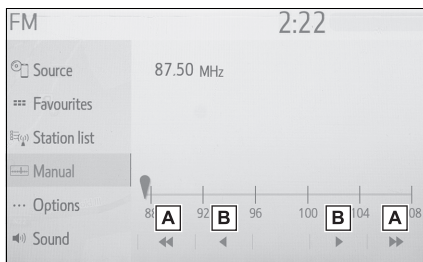

- A** Select to seek up/down for a station.
 - B** Select to step up/down frequencies.
- DAB
- 1 Select "Manual".

- 2 Tune the desired DAB ensemble or service.

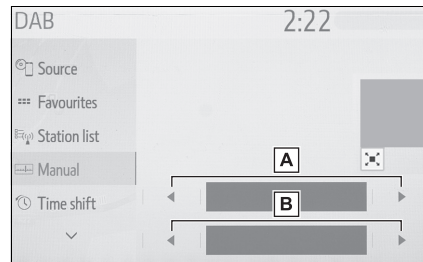

- A** Select to set the desired ensemble.
- B** Select to set the desired service/station.

Radio options

- 1 Select "Options".
 - 2 Select the desired item.
- FM

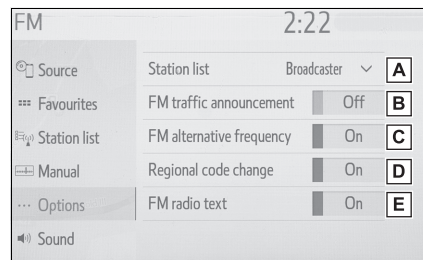

- A** Select to set the listing order of the station list between "Broadcaster" and "Alphabetical".
- B** Select to set the FM traffic announcement on/off. (→P.65)
- C** Select to set the FM alternative frequency function on/off. (→P.65)

D Select to switch to a broadcasting station within the same local program network.

E Select to set the FM radio text feature on/off.

► DAB

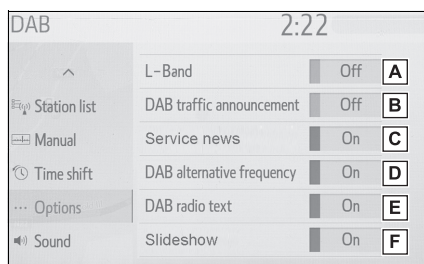

A Select on/off to set L-band in the tune range. When “Off” is selected, the physical channel range for tuning operations is limited to Band III, excluding for preset operations. When “On” is selected, the physical channel range for tuning operations includes Band III and L-band.

B Select to set the DAB traffic announcement on/off. (→P.65)

C Select to set the “Service news” announcements on/off. (→P.66)

D Select to set the DAB alternative frequency function on/off. (→P.65)

E Select on/off to set the DAB text feature.

F Select to set the slideshow fea-

ture on/off.

- Radio settings can be set on the audio settings screen. (→P.80)

Time shift operation (DAB)

The service you are currently listening to can be re-listened to at any time.

- 1 Select “Time shift”.
- 2 Select the desired operation button.

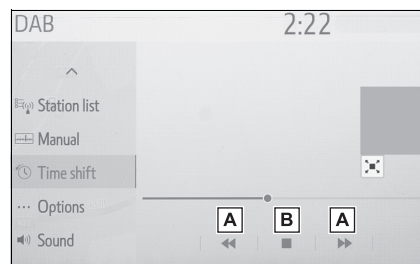

A Select to jump forward/backward by 10 seconds. Select and hold to fast forward/backward.

B Returns to the live radio broadcast.

- The times at which playback is possible depend on the bit rate of the service to be recorded, the amount of DAB unit memory, and the time at which reception of the broadcast began.

RDS (Radio data system)

This feature allows your radio to receive station and programmed information from radio stations which broadcast this information.

Depending on the availability of RDS infrastructure, the service may not function properly.

AF (Alternative frequency) function (FM/DAB)

A station providing good reception is automatically selected if current reception worsens.

TA (Traffic announcement) function (FM/DAB)

The tuner will automatically seek a station that regularly broadcasts traffic information and the station broadcasts when the traffic information program starts.

- 1 A pop-up message is displayed on the screen when the radio seeks out a TP station.
- 2 Select "Continue".

- When traffic announcement is set to on (→P.64), the radio will begin seeking a TP station.
- When the program ends, the initial operation resumes.

Traffic announcement volume function

The volume level when receiving the traffic announcement is memorized.

"Service news" announcements (DAB)

When there is a DAB announcement broadcast (such as news,

weather information, alerts, or warnings), it will interrupt the current program and broadcast the DAB announcement.

- When "Service news" is set to on (→P.64), the system will receive the DAB announcement broadcast.
- When the announcement ends, system resumes the previous program.
- Alarm announcements are broadcast even if the settings is off.

USB memory

Overview

The USB memory operation screen can be reached by the following methods: →P.57

- Connecting a USB memory (→P.58)
- When an Apple CarPlay/Android Auto connection is established, this function will be unavailable.

Control screen

▶ USB audio

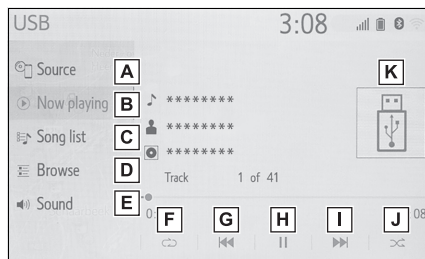

- A** Select to display the audio source selection screen.
- B** Select to return to the top screen.
- C** Select to display a song list screen.
- D** Select to display the play mode selection screen.
- E** Select to display the sound setting screen. (→P.58)
- F** Select to set repeat playback.

(→P.68)

- G** Select to change the file/track. Select and hold to fast rewind.
 - H** Select to play/pause.
 - I** Select to change the file/track. Select and hold to fast forward.
 - J** Select to set random playback. (→P.68)
 - K** Displays cover art
- ▶ USB video
- 1 Select "Browse".
 - 2 Select "Videos".
 - 3 Select the desired folder and file.

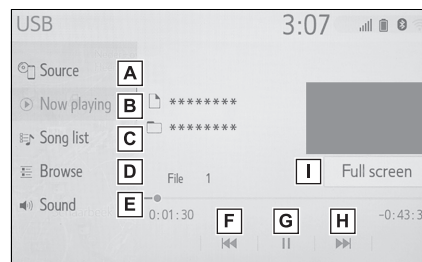

- A** Select to display the audio source selection screen.
- B** Select to return to the top screen.
- C** Select to display a song list screen.
- D** Select to display the play mode selection screen.
- E** Select to display the sound setting screen. (→P.58)

- F** Select to change the file. Select and hold to fast rewind.
- G** Select to play/pause.
- H** Select to change the file. Select and hold to fast forward.
- I** Select to display a full screen image.

Control panel

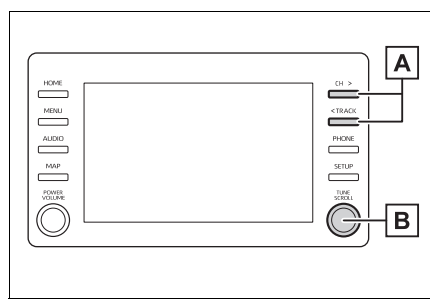

- A** Press to change the file/track. Press and hold to fast forward/rewind.
- B** Turn to change the file/track. Turn to move up/down the list. Also, the knob can be used to enter selections on the list screens by pressing it.

- While the vehicle is being driven, this function can only output sound.
- If tag information exists, the file/folder names will be changed to track/album names.

Repeating

The file/track or folder/album cur-

rently being listened to can be repeated.

- 1 Select

- Each time is selected, the mode changes as follows:
 - ▶ When random playback is off
 - file/track repeat → folder/album repeat → off
 - ▶ When random playback is on
 - file/track repeat → off

Random order

Files/tracks or folders/albums can be automatically and randomly selected.

- 1 Select

- Each time is selected, the mode changes as follows:
 - random (1 folder/album random) → folder/album random (all folder/album random) → off

WARNING

- Do not operate the player's controls or connect the USB memory while driving.

NOTICE

- Do not leave your portable player in the vehicle. In particular, high temperatures inside the vehicle may damage the portable player.
- Do not push down on or apply unnecessary pressure to the portable player while it is connected as this may damage the portable player or its terminal.

**NOTICE**

- Do not insert foreign objects into the port as this may damage the portable player or its terminal.

iPod/iPhone (Apple CarPlay*)

*: This function is not made available in some countries or areas

Overview

The iPod/iPhone operation screen can be reached by the following methods: →P.57

- Connecting an iPod/iPhone (→P.58)
- When an Android Auto connection is established, this function will be unavailable.

Control screen

- ▶ An Apple CarPlay connection is not established

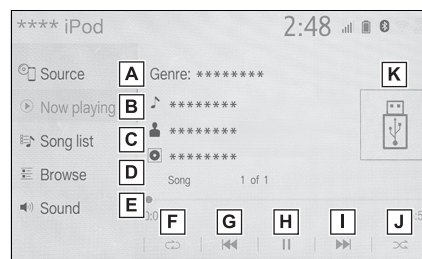

- ▶ An Apple CarPlay connection is established

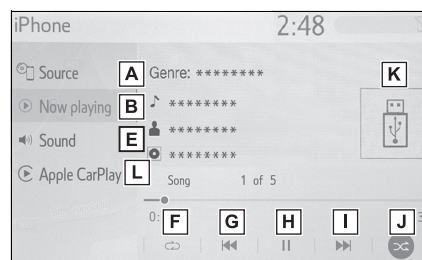

- A** Select to display the audio source selection screen.
- B** Select to return to the top screen.
- C** Select to display a song list screen.
- D** Select to display the play mode selection screen.
- E** Select to display the sound setting screen. (→P.58)
- F** Select to set repeat playback. (→P.71)
- G** Select to change the track. Select and hold to fast rewind.
- H** Select to play/pause.
- I** Select to change the track. Select and hold to fast forward.
- J** Select to set random playback. (→P.71)
- K** Displays cover art
- L** Select to display the audio control screen of Apple CarPlay.

Control panel

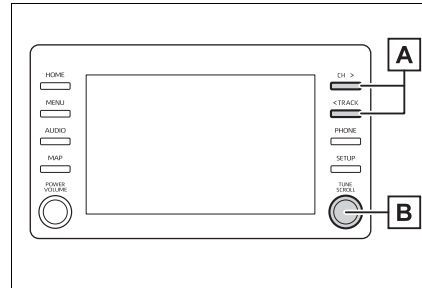

- A** Press to change the track. Press and hold to fast forward/rewind.
- B** Turn to move up/down the list. Also, the knob can be used to enter selections on the list screens by pressing it.

- Some functions may not be available depending on the type of model.
- When an iPod/iPhone is connected using a genuine iPod/iPhone cable, the iPod/iPhone starts charging its battery.
- Depending on the iPod/iPhone, the video sound may not be able to be heard.
- Depending on the iPod/iPhone and the songs in the iPod/iPhone, cover art may be displayed. This function can be changed to "On" or "Off". (→P.80) It may take time to display cover art, and the iPod/iPhone may not be operated while the cover art display is in process.
- When an iPod/iPhone is connected and the audio source is changed to iPod/iPhone mode, the iPod/iPhone will resume playing from the same point it was last used.
- Depending on the iPod/iPhone that is connected to the system, certain functions may not be available.

- Tracks selected by operating a connected iPod/iPhone may not be recognized or displayed properly.
- The system may not function properly if a conversion adapter is used to connect a device.

Repeating

The track currently being listened to can be repeated.

- 1 Select .

- Each time  is selected, the mode changes as follows:
 - ▶ When shuffle is off (iPhone 5 or later)
 - track repeat → album repeat → off
 - ▶ When shuffle is off (iPhone 4s or earlier)
 - track repeat → off
 - ▶ When shuffle is on
 - track repeat → off

Random order

Tracks or albums can be automatically and randomly selected.

- 1 Select .

- Each time  is selected, the mode changes as follows:
 - shuffle (1 album shuffle) → album shuffle (all album shuffle) → off



WARNING

- Do not operate the player's controls or connect the iPod while driving.



NOTICE

- Do not leave your portable player in the vehicle. In particular, high temperatures inside the vehicle may damage the portable player.
- Do not push down on or apply unnecessary pressure to the portable player while it is connected as this may damage the portable player or its terminal.
- Do not insert foreign objects into the port as this may damage the portable player or its terminal.

Android Auto*

*: This function is not made available in some countries or areas.

Overview

The Android Auto operation screen can be reached by the following methods: →P.57

- Connecting an Android Auto device (→P.58)
- When an Apple CarPlay connection is established, this function will be unavailable.

Control screen

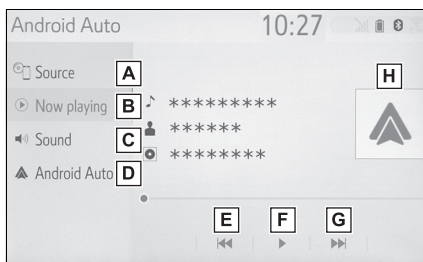

- A** Select to display the audio source selection screen.
- B** Select to return to the top screen.
- C** Select to display the sound setting screen. (→P.58)
- D** Select to display the audio control screen of Android Auto.
- E** Select to change the track.
- F** Select to play/pause.

G Select to change the track.

H Displays cover art

Control panel

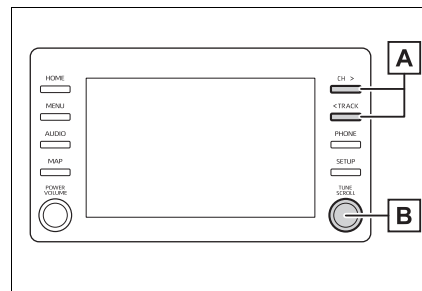

A Press to change the track.

B Turn to change the track.

WARNING

- Do not connect smartphone or operate the controls while driving.

NOTICE

- Do not leave your smartphone in the vehicle. In particular, high temperatures inside the vehicle may damage the smartphone.
- Do not push down on or apply unnecessary pressure to the smartphone while it is connected as this may damage the smartphone or its terminal.
- Do not insert foreign objects into the port as this may damage the smartphone or its terminal.

Bluetooth® audio

The Bluetooth® audio system enables users to enjoy listening to music that is played on a portable player on the vehicle speakers via wireless communication.

This audio/visual system supports Bluetooth®, a wireless data system capable of playing portable audio music without cables. If your device does not support Bluetooth®, the Bluetooth® audio system will not function.

Overview

The Bluetooth® audio operation screen can be reached by the following methods: →P.57

- Connecting a Bluetooth® audio device (→P.75)
- Depending on the type of portable player connected, some functions may not be available and/or the screen may look differently than shown in this manual.
- When an Apple CarPlay/Android Auto connection is established, Bluetooth® audio will be suspended and become unavailable.

Control screen

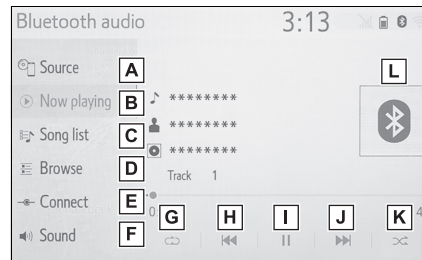

- A** Select to display the audio source selection screen.
- B** Select to return to the top screen.
- C** Select to display a song list screen.
- D** Select to display the play mode selection screen.
- E** Select to display the portable device connection screen. (→P.75)
- F** Select to display the sound setting screen. (→P.58)
- G** Select to set repeat playback. (→P.74)
- H** Select to change the track. Select and hold to fast rewind.
- I** Select to play/pause.
- J** Select to change the track. Select and hold to fast forward.
- K** Select to set random playback. (→P.74)

L Displays cover art

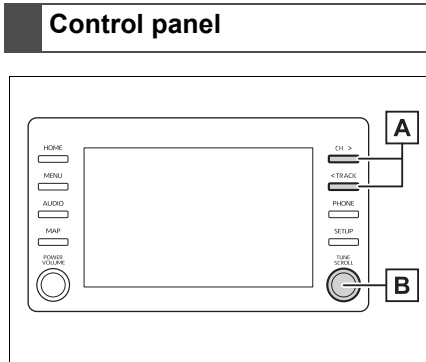

A Press to change the track. Press and hold to fast forward/rewind.

B Turn to move up/down the list. Also, the knob can be used to enter selections on the list screens by pressing it.

Repeating

The track or album currently being listened to can be repeated.



1 Select .

- Each time  is selected, the mode changes as follows:
 - ▶ When random playback is off
 - repeat all → track repeat → album repeat → off
 - ▶ When random playback is on
 - repeat all → track repeat → off

Random order

Tracks or albums can be automatically and randomly selected.

1 Select .

- Each time  is selected, the mode changes as follows:
 - random (1 album random) → album random (all album random) → off
- Depending on the Bluetooth® device that is connected to the system, the music may start playing when selecting  while it is paused. Conversely, the music may pause when selecting  while it is playing.
- In the following conditions, the system may not function:
 - The Bluetooth® device is turned off.
 - The Bluetooth® device is not connected.
 - The Bluetooth® device has a low battery.
- When using the Bluetooth® audio and Wi-Fi® functions at the same time, the following problems may occur:
 - It may take longer than normal to connect to the Bluetooth® device.
 - The sound may cut out.
- It may take time to connect the phone when Bluetooth® audio is being played.
- For operating the portable player, see the instruction manual that comes with it.
- If the Bluetooth® device is disconnected due to poor reception from the Bluetooth® network when the engine switch is in ACC or ON, the system will automatically reconnect to the portable player.
- If the Bluetooth® device is disconnected on purpose, such as it was turned off, this does not happen. Reconnect the portable player manually.

- Bluetooth® device information is registered when the Bluetooth® device is connected to the Bluetooth® audio system. When selling or disposing of the vehicle, remove the Bluetooth® audio information from the system. (→P.51)
- In some situations, sound output via the Bluetooth® audio system may be out of sync with the connected device or output intermittently.

WARNING

- Do not operate the player's controls or connect to the Bluetooth® audio system while driving.
- Your audio unit is fitted with Bluetooth® antennas. People with implantable cardiac pacemakers, cardiac resynchronization therapy-pacemakers or implantable cardioverter defibrillators should maintain a reasonable distance between themselves and the Bluetooth® antennas. The radio waves may affect the operation of such devices.
- Before using Bluetooth® devices, users of any electrical medical device other than implantable cardiac pacemakers, cardiac resynchronization therapy-pacemakers or implantable cardioverter defibrillators should consult the manufacturer of the device for information about its operation under the influence of radio waves. Radio waves could have unexpected effects on the operation of such medical devices.

NOTICE

- Do not leave your portable player in the vehicle. In particular, high temperatures inside the vehicle may damage the portable player.

Registering/Connecting a Bluetooth® device

3

Audio/visual system

To use the Bluetooth® audio system, it is necessary to register a Bluetooth® device with the system.

- ▶ Registering an additional device
 - 1 Display the Bluetooth® audio control screen. (→P.73)
 - 2 Select "Connect".
 - 3 Select "Add device".
- When another Bluetooth® device is connected, a confirmation screen will be displayed. To disconnect the Bluetooth® device, select "Yes".
- 4 Follow the steps in "Registering a Bluetooth® phone for the first time" from step 5. (→P.28)
- ▶ Selecting a registered device
 - 1 Display the Bluetooth® audio control screen. (→P.73)
 - 2 Select "Connect".
 - 3 Select the desired device to be connected.
 - 4 Check that a confirmation screen is displayed when the connection is complete.
- If an error message is displayed,

follow the guidance on the screen to try again.

Miracast®

Miracast® is a function that enables the audio/visual system to display smartphone's screen and play the smartphone's sound by connecting the smartphone to the audio/visual system with Wi-Fi® connection (P2P mode).

This function is not available if the smartphone is not certified by Wi-Fi Alliance® as Miracast® device. (Whether or not a device is a Wi-Fi Alliance® certified Miracast® device can be checked at <https://www.wi-fi.org/>.)

While the vehicle is being driven, this function can only output sound.

- Miracast® performs wireless communication using the same 2.4 GHz radio frequency band as Bluetooth®. Depending on the usage environment, radio wave interference may occur, resulting in image distortion and audio stuttering. If interference occurs, connecting a Bluetooth® cellular phone or portable device that is registered with the system may reduce the effects.
- Miracast® is a registered trademark of Wi-Fi Alliance®.

Overview

The Miracast® control screen can

be reached by the following methods: →P.57

- Connecting a Miracast[®] device (→P.77)

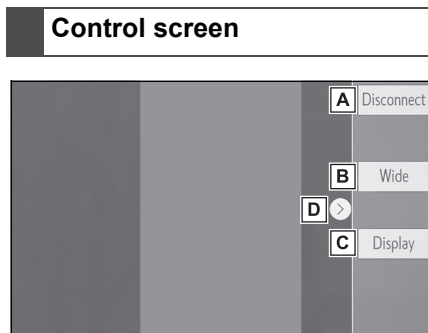

- A** Select to disconnect the Miracast[®] device.
- B** Select to change the screen size. (→P.59)
- C** Select to display the image quality adjustment screen. (→P.59)
- D** Select to display/hide the control button.

- When “Access to network” (→P.39) is set to “On”, Wi-Fi[®] network connection communication and Miracast[®] communication may affect each other, causing image distortion and audio stuttering. If this occurs, setting “Access to network” to “Off” may reduce the effects.
- The Miracast[®] sound volume takes into account the sound volume of both the system and the connected device. Before using Miracast[®], adjust the sound volume of the connected device to an appropriate level.
- When a device that uses Bluetooth[®]

audio is used with Miracast[®], no sound may be output from Miracast[®]. If this occurs, disabling the Bluetooth[®] audio may allow sound to be output from Miracast[®].

- The Miracast[®] screen displays the same image that is sent from the external device. If the external device screen is vertically-oriented, the screen may also display a vertical image.

WARNING

- Do not connect smartphone or operate the controls while driving.

NOTICE

- Do not leave your smartphone in the vehicle. In particular, high temperatures inside the vehicle may damage the smartphone.

Connecting a Miracast[®] device

Miracast[®] is available when the Wi-Fi[®] function is enabled. (→P.39)

- 1 Turn the Miracast[®] function of your smartphone on.
 - 2 Select “Miracast™” on the audio source selection screen. (→P.57)
- The system will automatically start searching for a Miracast[®] compatible device.

78 3-3. Media operation

- 3 Check that the following screen is displayed when the device is found.

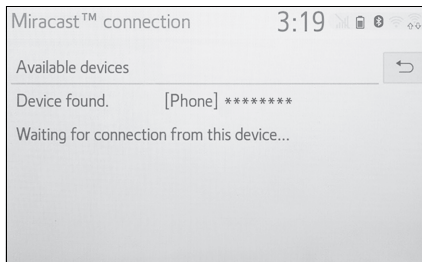

- If the device has been connected to the system before, this screen may not be displayed and the Miracast® connection may start immediately.
- 4 Select the system name on the smartphone.
 - 5 Select "Yes".

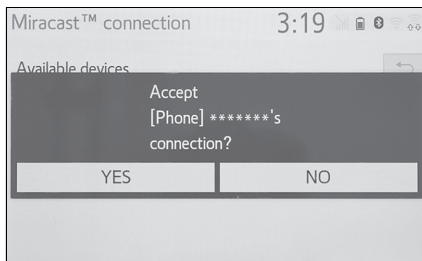

- 6 Check that Miracast® operation screen is displayed.
- Depending on the device connected, it may take approximately 5 to 15 seconds before the Miracast® operation screen is displayed.

- The signal strength/status of the Wi-Fi® connection (P2P mode) is displayed on the upper right side of the

screen. (→P.14)

- To check the Miracast® setting on the Wi-Fi® setting screen (→P.39)

Steering switches

Steering switch operation

Some parts of the audio/visual system can be adjusted using the switches on the steering wheel.

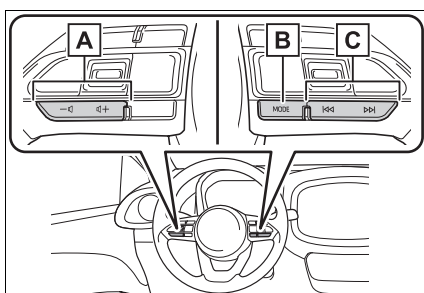

A Volume control switch

Mode	Operation/function
All	Press: Volume up/down
	Press and hold: Volume up/down continuously

B "MODE" switch

Mode	Operation/function
FM/DAB	Press: Change audio modes
	Press and hold: Mute (Press and hold again to resume the sound.)
USB, iPod/iPhone, Bluetooth® audio, Android Auto	Press: Change audio modes
	Press and hold: Pause (Press and hold again to resume the play mode.)
Miracast®	Press: Change audio modes

C Seek switch

Mode	Operation/function
FM	Press: Preset stations up/down (Favourites screen)
	Station up/down (Station list screen)
	Seek up/down (Manual tuning screen)
	Press and hold: Seek up/down continuously while the switch is being pressed (Manual tuning screen)
DAB	Press: Preset services/stations up/down (Favourites screen)
	Service/station up/down (Service/station list screen)
	Seek up/down (Manual tuning screen)
	Press and hold: Seek up/down continuously while the switch is being pressed (Manual tuning screen)
USB, iPod/iPhone, Bluetooth® audio	Press: Track/file up/down
	Press and hold: Fast forward/rewind
Android Auto	Press: Track up/down

Audio settings

Detailed audio settings can be programmed.

Displaying the audio settings screen

- 1 Press the "SETUP" button.

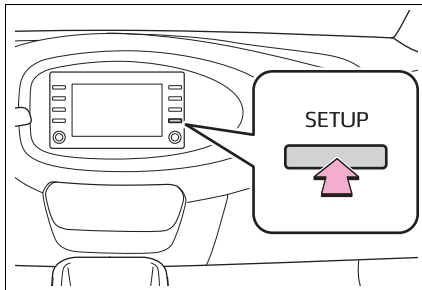

- 2 Select "Audio".
- 3 Select the desired items to be set.

Audio settings screen

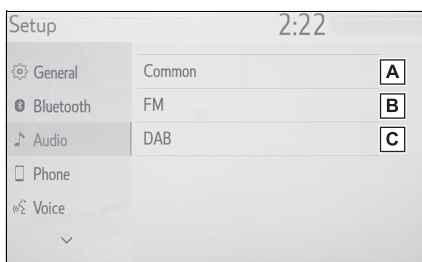

- A** Select to set the common settings. (→P.80)
- B** Select to set detailed FM radio settings. (→P.64)
- C** Select to set detailed DAB set-

tings.* (→P.64)

*: If equipped

Common settings

- 1 Display the audio settings screen. (→P.80)
- 2 Select "Common".
- 3 Select the desired items to be set.

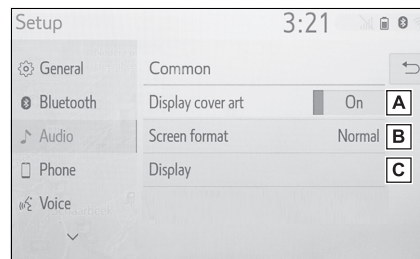

- A** Select to set the cover art display on/off.
- B** Select to change the screen format for video output.* (→P.59)
- C** Select to display the image quality adjustment screen.* (→P.60)

*: Depending on the audio source, some functions may not be available.

Operating information

- The use of a cellular phone inside or near the vehicle may cause a noise from the speakers of the audio/visual system which you are listening to. However, this does not indicate a malfunction.



NOTICE

- To avoid damage to the audio/visual system:
 - Be careful not to spill beverages over the audio/visual system.

Radio

Usually, a problem with radio reception does not mean there is a problem with the radio — it is just the normal result of conditions outside the vehicle.

For example, nearby buildings and terrain can interfere with FM reception. And of course, radio signals have a limited range. The farther the vehicle is from a station, the weaker its signal will be. In addition, reception conditions change constantly as the vehicle moves.

Here, some common reception problems that probably do not indicate a problem with the radio are described.

■ FM

Fading and drifting stations: Generally, the effective range of FM is about 40 km (25 miles). Once outside this range, you may notice fading

and drifting, which increase with the distance from the radio transmitter. They are often accompanied by distortion.

Multi-path: FM signals are reflective, making it possible for 2 signals to reach the vehicle's antenna at the same time. If this happens, the signals will cancel each other out, causing a momentary flutter or loss of reception.

Static and fluttering: These occur when signals are blocked by buildings, trees or other large objects. Increasing the bass level may reduce static and fluttering.

Station swapping: If the FM signal being listened to is interrupted or weakened, and there is another strong station nearby on the FM band, the radio may tune in the second station until the original signal can be picked up again.

iPod/iPhone

■ Certification



- Use of the Made for Apple badge means that an accessory has been designed to connect specifically to the Apple product(s)

identified in the badge, and has been certified by the developer to meet Apple performance standards. Apple is not responsible for the operation of this vehicle or its compliance with safety and regulatory standards. Please note that the use of this accessory with an Apple product may affect wireless performance.

- iPhone®, iPod®, iPod nano®, iPod touch®, and Lightning® are trademarks of Apple Inc., registered in the U.S. and other countries. Apple CarPlay is a trademark of Apple Inc.

■ Compatible models

Made for

- iPhone X
- iPhone 8
- iPhone 8 Plus
- iPhone 7
- iPhone 7 Plus
- iPhone SE
- iPhone 6s
- iPhone 6s Plus
- iPhone 6
- iPhone 6 Plus
- iPhone 5s
- iPhone 5c
- iPhone 5
- iPhone 4s
- iPod touch (6th generation)
- iPod touch (5th generation)
- iPod nano (7th generation)

- This system only supports audio playback.

- Depending on differences between models or software versions etc., some models might be incompatible with this system.

High-resolution sound source

This device supports high-resolution sound sources.

The definition of high-resolution is based on the standards of groups such as the CTA (Consumer Technology Association).

Supported formats and playable media are as follows.

■ Supported formats

WAV, FLAC, ALAC, OGG Vorbis

■ Playable media

USB memory

File information

Compatible USB devices

USB communication formats	USB 2.0 HS (480 Mbps)
File formats	FAT 16/32
Correspondence class	Mass storage class

Compatible audio format**Compatible compressed files**

Item	USB
Compatible file format	MP3/WMA/AAC
	WAV(LPCM)/FLAC /ALAC/OGG Vorbis
	MP4/AVI/WMV
Compatible file format (video)*	MP4/AVI/WMV
Folders in the device	Maximum 3000
Files in the device	Maximum 9999
Files per folder	Maximum 255

*: USB video only

Corresponding sampling frequency

File type	Frequency (kHz)
MP3 files: MPEG 1 LAYER 3	32/44.1/48
MP3 files: MPEG 2 LSF LAYER 3	16/22.05/24
WMA files: Ver. 7, 8, 9* ¹ (9.1/9.2)	32/44.1/48
AAC files: MPEG4/AAC-LC	11.025/12/16/ 22.05/24/32/ 44.1/48

File type	Frequency (kHz)
WAV (LPCM) files* ²	8/11.025/12/16/ 22.05/24/32/ 44.1/48/88.2/ 96/176.4/192
FLAC* ²	8/11.025/12/16/ 22.05/24/32/ 44.1/48/88.2/ 96/176.4/192
ALAC* ²	8/11.025/12/16/ 22.05/24/32/ 44.1/48/64/ 88.2/96
OGG Vorbis* ²	8/11.025/16/ 22.05/32/44.1/ 48

*¹: Only compatible with Windows Media Audio Standard

*²: Sound source of 48kHz or more is down-converted to 48kHz/24bit.

Corresponding bit rates*¹

File type	Bit rate (kbps)
MP3 files: MPEG 1 LAYER 3	32 - 320
MP3 files: MPEG 2 LSF LAYER 3	8 - 160
WMA files: Ver. 7, 8	CBR 48 - 192
WMA files: Ver. 9* ² (9.1/9.2)	CBR 48 - 320
AAC files: MPEG4/AAC-LC	8 - 320
OGG Vorbis	32 - 500

*1: Variable Bit Rate (VBR) compatible

*2: Only compatible with Windows Media Audio Standard

File type	Quantization bit rate (bit)
WAV(LPCM) files	16/24
FLAC	
ALAC	

Compatible channel modes

File type	Channel mode
MP3 files	Stereo, joint stereo, dual channel and monaural
WMA files	2ch
AAC files	1ch, 2ch (Dual channel is not supported)
WAV (LPCM)/FLAC/ALAC/OGG Vorbis	2ch

- MP3 (MPEG Audio Layer 3), WMA (Windows Media Audio) and AAC (Advanced Audio Coding) are audio compression standards.
- This system can play MP3/WMA/AAC files on USB memory.
- MP4, WMV and AVI files can use the following resolutions: 128x96, 160x120, 176x144 (QCIF), 320x240 (QVGA), 352x240 (SIF), 352x288 (CIF), 640x480 (VGA), 720x480 (NTSC), 720x576 (PAL)

- When naming an MP3/WMA/AAC file, add an appropriate file extension (.mp3/.wma/.m4a).
- This system plays back files with .mp3/.wma/.m4a file extensions as MP3/WMA/AAC files respectively. To prevent noise and playback errors, use the appropriate file extension.
- MP3 files are compatible with the ID3 Tag Ver. 1.0, Ver. 1.1, Ver. 2.2 and Ver. 2.3 formats. This system cannot display track title and artist name in other formats.
- WMA/AAC files can contain a WMA/AAC tag that is used in the same way as an ID3 tag. WMA/AAC tags carry information such as track title and artist name.
- The emphasis function is available only when playing MP3 files.
- This system can play back AAC files encoded by iTunes.
- The sound quality of MP3/WMA files generally improves with higher bit rates.
- m3u playlists are not compatible with the audio player.
- MP3i (MP3 interactive) and MP3PRO formats are not compatible with the audio player.
- The player is compatible with VBR (Variable Bit Rate).
- When playing back files

recorded as VBR (Variable Bit Rate) files, the play time will not be correctly displayed if the fast forward or reverse operations are used.

- It is not possible to check folders that do not include MP3/WMA/AAC files.
- MP3/WMA/AAC files in folders up to 8 levels deep can be played. However, the start of playback may be delayed when using USB memory containing numerous levels of folders. For this reason, we recommend creating USB memory with no more than 2 levels of folders.

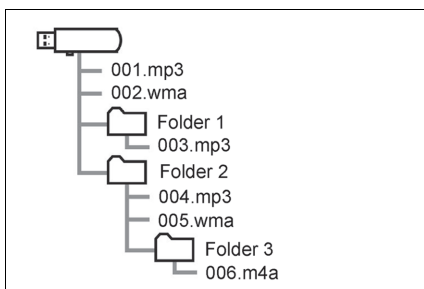

- The play order of the USB memory with the structure shown above is as follows:

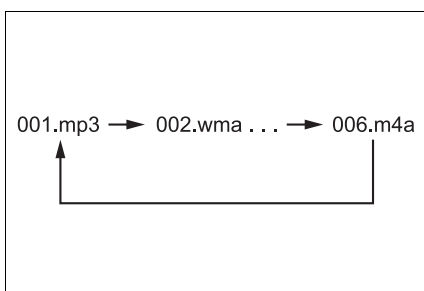

- The order changes depending

on the personal computer and MP3/WMA/AAC encoding software you use.

Compatible video format

Format	Codec
MPEG-4	Video codec: <ul style="list-style-type: none"> • H.264/MPEG-4 AVC • MPEG4 Audio codec: <ul style="list-style-type: none"> • AAC • MP3 Corresponding screen size: <ul style="list-style-type: none"> • MAX 1920×1080 Corresponding frame rate: <ul style="list-style-type: none"> • MAX 60i/30p

Format	Codec
AVI Container	Video codec: <ul style="list-style-type: none"> • H.264/MPEG-4 AVC • MPEG4 • WMV9 • WMV9 Advanced profile Audio codec: <ul style="list-style-type: none"> • AAC • MP3 • WMA9.2 (7, 8, 9.1, 9.2) Corresponding screen size: <ul style="list-style-type: none"> • MAX 1920×1080 Corresponding frame rate: <ul style="list-style-type: none"> • MAX 60i/30p
Windows Media Video	Video codec: <ul style="list-style-type: none"> • WMV9 • WMV9 Advanced profile Audio codec: <ul style="list-style-type: none"> • WMA9.2 (7, 8, 9.1, 9.2) Corresponding screen size: <ul style="list-style-type: none"> • MAX 1920×1080 Corresponding frame rate: <ul style="list-style-type: none"> • MAX 60i/30p

Terms

■ ID3 tag

- This is a method of embedding track-related information in an MP3 file. This embedded information can include the track

number, track title, the artist's name, the album title, the music genre, the year of production, comments, cover art and other data. The contents can be freely edited using software with ID3 tag editing functions. Although the tags are restricted to a number of characters, the information can be viewed when the track is played back.

■ WMA tag

- WMA files can contain a WMA tag that is used in the same way as an ID3 tag. WMA tags carry information such as track title and artist name.

■ MP3

- MP3 is an audio compression standard determined by a working group (MPEG) of the ISO (International Standard Organization). MP3 compresses audio data to about 1/10 the size of that on conventional discs.

■ WMA

- WMA (Windows Media Audio) is an audio compression format developed by Microsoft®. It compresses files into a size smaller than that of MP3 files. The decoding formats for WMA files are Ver. 7, 8 and 9.
- Trademark Acknowledgement Windows Media is either a registered trademark or trademark of Microsoft Corporation in the

United States and/or other countries.

This product is protected by certain intellectual property rights of Microsoft. Use or distribution of such technology outside of this product is prohibited without a license from Microsoft.

■ AAC

- AAC is short for Advanced Audio Coding and refers to an audio compression technology standard used with MPEG2 and MPEG4.

■ MPEG4

- This product is licensed under the MPEG-4 patent portfolio license, AVC patent portfolio license and VC-1 patent portfolio license for the personal use of a consumer or other uses in which it does not receive remuneration to
 - encode video in compliance with the MPEG-4 Visual Standard, AVC Standard and VC-1 Standard ("MPEG-4/AVC/VC-1 Video") and/or
 - decode MPEG-4/AVC/VC-1 Video that was encoded by a consumer engaged in a personal activity and/or was obtained from a video provider licensed to provide MPEG-4/AVC/VC-1 Video. No license is granted or shall be implied for any other use. Additional information may be obtained from MPEG LA, L.L.C.

See <http://www.mpegla.com>.

Error messages

■ USB

Message	Explanation
"USB error"	This indicates a problem in the USB memory or its connection.
"No music files found."	This indicates that no compatible files are included in the USB memory.
"No video files found."	This indicates that no video files are included in the USB memory.

■ iPod

Message	Explanation
"iPod error"	This indicates a problem in the iPod or its connection.
"No music files found."	This indicates that there is no music data in the iPod.

Message	Explanation
"Check the iPod firmware version."	This indicates that the firmware version is not compatible. Perform the iPod firmware updates and try again.
"iPod authorization unsuccessful."	This indicates that it failed to authorize the iPod. Please check your iPod.

■ Bluetooth® audio

Message	Explanation
"Music tracks not supported. Check your portable player."	This indicates a problem in the Bluetooth® device.

- If the malfunction is not rectified, take your vehicle to any Toyota retailer or Toyota authorized repairer, or any reliable repairer.

Speech command system

4

89

4-1. Speech command system operation

Speech command system .. 90

Command list..... 92

4

Speech command system

For vehicles sold outside Europe, some of the functions cannot be operated while driving.

Speech command system

The speech command system enables the radio, phone dialing, etc. to be operated using speech commands.

- Voice recognition language can be changed. →P.49
- This function is compatible with the following languages:
 - English
 - French
 - German
 - Spanish
 - Italian
 - Dutch
 - Portuguese
 - Polish
 - Czech
 - Danish
 - Norwegian
 - Swedish
 - Finnish
 - Russian
 - Greek
 - Turkish
 - Flemish

Using the speech command system

Steering switch

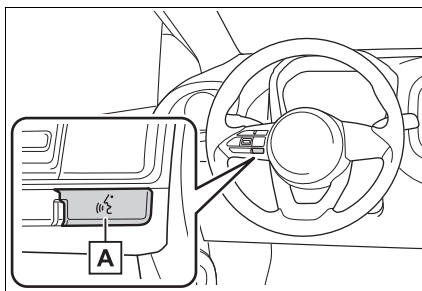

A Talk switch

- Press the talk switch to start the speech command system.
- To cancel speech command, press and hold the talk switch.

When an Apple CarPlay/Android Auto connection is established:

- Press and hold the talk switch to start Siri/Google Assistant. To cancel Siri/Google Assistant, press the talk switch.

Microphone

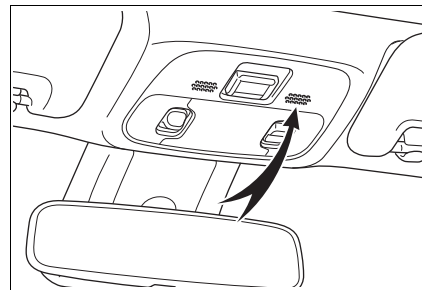

- It is unnecessary to speak directly into the microphone when giving a command.
- Speech commands may not be recognized if:
 - Spoken too quickly.
 - Spoken at a low or high volume.
 - The windows are open.
 - Passengers are talking while speech commands are spoken.
 - The fan speed of the air conditioning system is set at high.
 - The air conditioning vents are turned towards the microphone.
- In the following conditions, the system may not recognize the command properly and using speech commands may not be possible:
 - The command is incorrect or unclear. Note that certain words, accents or speech patterns may be difficult for the system to recognize.
 - There is excessive background noise, such as wind noise.

- Wait for the confirmation beep before speaking a command.
- This system may not operate immediately after the engine switch is turned to ACC or ON.

Speech command system operation

- 1 Press the talk switch.
 - The speech command system is activated.
 - Pressing the talk switch while a voice prompt is playing, will stop the voice recognition prompt and immediately play the start listening tone.
 - While in voice recognition mode, pressing and holding the talk switch for 1 or more seconds cancels voice recognition mode.
- 2 After a beep sounds, say the desired command or select the desired command.

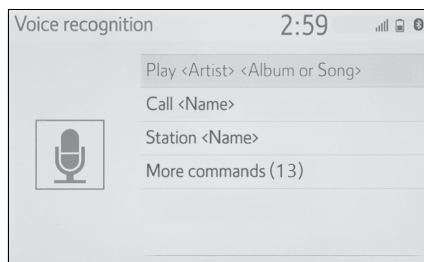

■ Displaying the command list screen

- 1 Say "More commands" or select "More commands" on the speech command main menu screen.

- 2 Say the desired command or select the desired command.

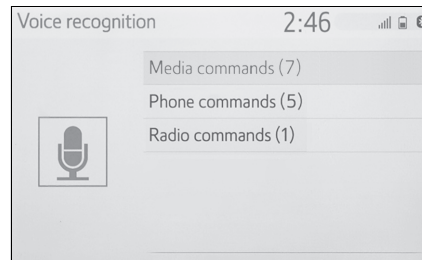

- The command list is read out and the corresponding command is highlighted. To cancel this function, press the talk switch.

Command list

Command list overview

Recognizable speech commands and their actions are shown below.

- Frequently used commands are listed in the following tables.
- For devices that are not installed to the vehicle, commands relating to that device may not function. Also, depending on other conditions, such as compatibility, some commands may not function.
- The functions available may vary according to the system installed.
- When an Apple CarPlay/Android Auto connection is established, some commands will become unavailable.

Command list

■ Common

Command	Action
“Correction”	Returns to the previous state
“Cancel”	Cancels the speech command system

■ Top menu

Command	Action
“More commands”	Displays more commonly used commands

■ Media

Command	Action
“Play <artist name> <album or song name>” ^{*1}	Plays tracks from the selected artist and album/song
“Artist <artist name>” ^{*1}	Plays tracks from the selected artist
“Album <album name>” ^{*1}	Plays tracks from the selected album
“Song <song name>” ^{*1}	Plays the selected track
“Play playlist <playlist name>” ^{*1, 2}	Plays tracks from the selected playlist

^{*1}: The audio device must be connected via a USB cable to use the functionality

^{*2}: Available only for iPod/iPhone

■ Phone

Command	Action
"Dial <phone number>"	Call the selected phone number
"Redial"	Call the phone number of the latest outgoing call
"Call <contacts>"	Call the selected phone contact
"Call <contacts> <phone types>"	Call the selected phone contact on its selected phone type

■ Radio

Command	Action
"Station <station name>"	Play the selected radio station

Peripheral monitoring system

5

95

5-1. Rear view monitor system

Rear view monitor system .. 96

Rear view monitor system precautions 98

Things you should know ... 102

5

Peripheral monitoring system

Rear view monitor system*

*: If equipped

The rear view monitor system assists the driver by displaying an image of the view behind the vehicle with fixed guide lines on the screen while backing up, for example while parking.

- The screen illustrations used in this text are intended as examples, and may differ from the image that is actually displayed on the screen.

Driving precautions

The rear view monitor system is a supplemental device intended to assist the driver when backing up. When backing up, be sure to visually check all around the vehicle both directly and using the mirrors before proceeding. If you do not, you may hit another vehicle, and could possibly cause an accident. Pay attention to the following precautions when using the rear view monitor system.

WARNING

- Never depend on the rear view monitor system entirely when backing up. The image and the position of the guide lines displayed on the screen may differ from the actual state. Use caution, just as you would when backing up any vehicle.

WARNING

- Be sure to back up slowly, depressing the brake pedal to control vehicle speed.
- The instructions given are only guide lines. When and how much to turn the steering wheel will vary according to traffic conditions, road surface conditions, vehicle condition, etc. when parking. It is necessary to be fully aware of this before using the rear view monitor system.
- When parking, be sure to check that the parking space will accommodate your vehicle before maneuvering into it.
- Do not use the rear view monitor system in the following cases:
 - On icy or slick road surfaces, or in snow
 - When using tyre chains or emergency tyres
 - When the back door is not closed completely
 - On roads that are not flat or straight, such as curves or slopes
- In low temperatures, the screen may darken or the image may become faint. The image could distort when the vehicle is moving, or you may become unable to see the image on the screen. Be sure to visually check all around the vehicle both directly and using the mirrors before proceeding.
- If the tyre sizes are changed, the position of the fixed guide lines displayed on the screen may change.
- The camera uses a special lens. The distances between objects and pedestrians that appear in the image displayed on the screen will differ from the actual distances. (→P.99)

Screen description

The rear view monitor system screen will be displayed if the shift position is shifted to the “R” position while the engine switch is in ON.

shifted into any position other than the “R” position.

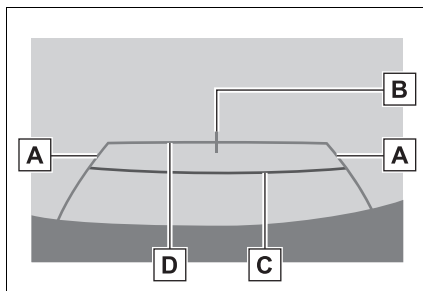

A Vehicle width guide line

Displays a guide path when the vehicle is being backed straight up.

- The displayed width is wider than the actual vehicle width.

B Vehicle centre guide line

This line indicates the estimated vehicle centre on the ground.

C Distance guide line

Shows distance behind the vehicle.

- Displays a point approximately 0.5 m (1.5 ft.) (red) from the edge of the bumper.

D Distance guide line

Shows distance behind the vehicle.

- Displays a point approximately 1 m (3 ft.) (blue) from the edge of the bumper.

Canceling rear view monitor system

The rear view monitor system is canceled when the shift lever is

Rear view monitor system precautions

Area displayed on screen

The rear view monitor system displays an image of the view from the bumper of the rear area of the vehicle.

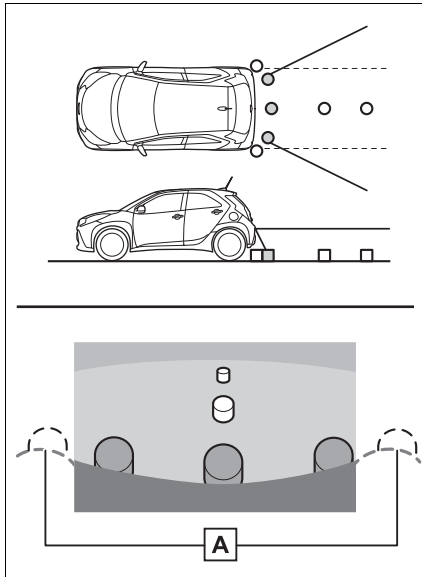

A Corners of bumper

- The area around both corners of the bumper will not be displayed.
- The image adjustment procedure for the rear view monitor system screen is the same as the procedure for adjusting the screen. (→P.25)
- The area displayed on the screen may vary according to vehicle orientation conditions.
- Objects which are close to either corner of the bumper or under the bumper cannot be displayed.

- The camera uses a special lens. The distance of the image that appears on the screen differs from the actual distance.
- Items which are located higher than the camera may not be displayed on the monitor.

The camera

The camera for the rear view monitor system is located as shown in the illustration.

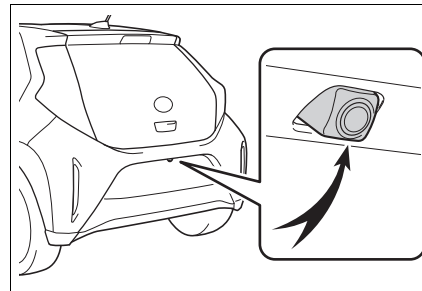

■ Using the camera

If dirt or foreign matter (such as water droplets, snow, mud, etc.) is adhering to the camera, it cannot transmit a clear image. In this case, flush it with a large quantity of water and wipe the camera lens clean with a soft and wet cloth.

⚠ NOTICE

- The rear view monitor system may not operate properly in the following cases.
 - If the back of the vehicle is hit, the position and mounting angle of the camera may change.
 - As the camera has a water proof construction, do not detach, disassemble or modify it. This may cause incorrect operation.

 NOTICE

- When cleaning the camera lens, flush the camera with a large quantity of water and wipe it with a soft and wet cloth. Strongly rubbing the camera lens may cause the camera lens to be scratched and unable to transmit a clear image.
- Do not allow organic solvent, car wax, window cleaner or a glass coating to adhere to the camera. If this happens, wipe it off as soon as possible.
- If the temperature changes rapidly, such as when hot water is poured on the vehicle in cold weather, the system may not operate normally.
- When washing the vehicle, do not apply intensive bursts of water to the camera or camera area. Doing so may result in the camera malfunctioning.
- Do not expose the camera to strong impact as this could cause a malfunction. If this happens, have the vehicle inspected by any Toyota retailer or Toyota authorized repairer, or any reliable repairer as soon as possible.

Differences between the screen and the actual road

- The distance guide lines and the vehicle width guide lines may not actually be parallel with the dividing lines of the parking space, even when they appear to be so. Be sure to check visually.
- The distances between the vehicle width guide lines and the left and right dividing lines of the parking space may not be equal,

even when they appear to be so. Be sure to check visually.

- The distance guide lines give a distance guide for flat road surfaces. In any of the following situations, there is a margin of error between the fixed guide lines on the screen and the actual distance/course on the road.

■ When the ground behind the vehicle slopes up sharply

The distance guide lines will appear to be closer to the vehicle than the actual distance. Because of this, objects will appear to be farther away than they actually are. In the same way, there will be a margin of error between the guide lines and the actual distance/course on the road.

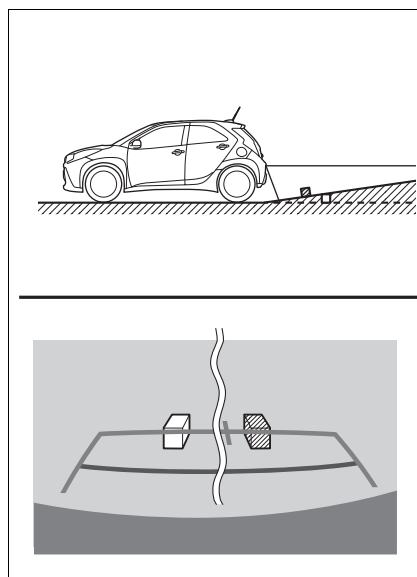

■ **When the ground behind the vehicle slopes down sharply**

The distance guide lines will appear to be farther from the vehicle than the actual distance. Because of this, objects will appear to be closer than they actually are. In the same way, there will be a margin of error between the guide lines and the actual distance/course on the road.

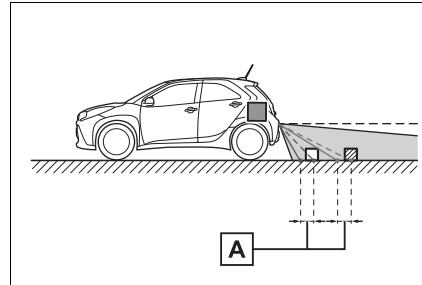

A A margin of error

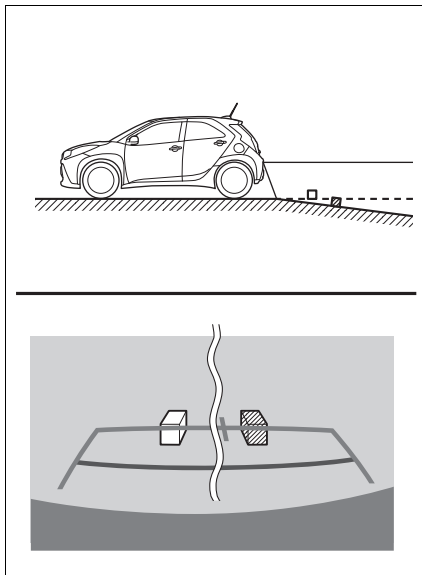

■ **When any part of the vehicle sags**

When any part of the vehicle sags due to the number of passengers or the distribution of the load, there is a margin of error between the fixed guide lines on the screen and the actual distance/course on the road.

When approaching three-dimensional objects

The distance guide lines are displayed according to flat surfaced objects (such as the road). It is not possible to determine the position of three-dimensional objects (such as vehicles) using the vehicle width guide lines and distance guide lines. When approaching a three-dimensional object that extends outward (such as the flatbed of a truck), be careful of the following.

■ **Vehicle width guide lines**

Visually check the surroundings and the area behind the vehicle. In the case shown below, the truck appears to be outside of the vehicle width guide lines and the vehicle does not look as if it hits the truck. However, the rear body of the truck may actually cross over the vehicle width guide lines. In reality if you back up as guided by the vehicle width guide lines, the vehicle may hit the truck.

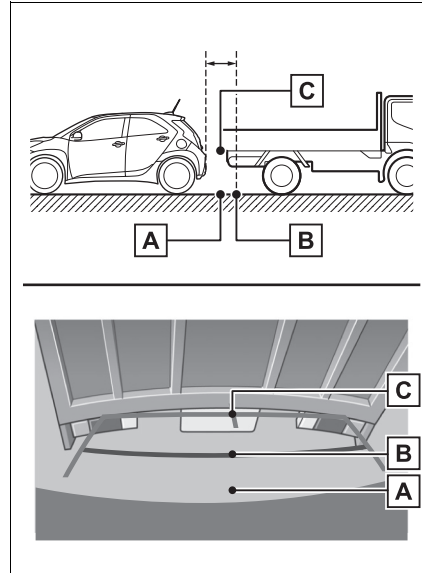
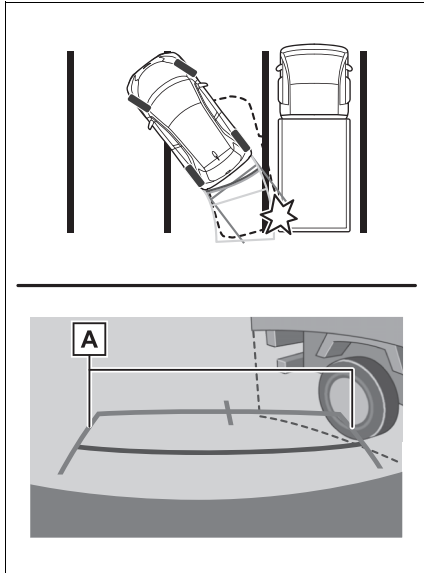

A Vehicle width guide lines

■ **Distance guide lines**

Visually check the surroundings and the area behind the vehicle. On the screen, it appears that a truck is parking at point **B**. However, in reality if you back up to point **A**, you will hit the truck. On the screen, you will hit the truck. On the screen, it appears that **A** is closest and **C** is farthest away. However, in reality, the distance to **A** and **C** is the same, and **B** is farther than **A** and **C**.

Things you should know

If you notice any symptoms

If you notice any of the following symptoms, refer to the likely cause and the solution, and re-check.

If the symptom is not resolved by the solution, have the vehicle inspected by any Toyota retailer or Toyota authorized repairer, or any reliable repairer.

Symptom	Likely cause	Solution
The image is difficult to see	<ul style="list-style-type: none"> • The vehicle is in a dark area • The temperature around the lens is either high or low • The outside temperature is low • There are water droplets on the camera • It is raining or humid • Foreign matter (mud etc.) is adhering to the camera • Sunlight or headlights are shining directly into the camera • The vehicle is under fluorescent lights, sodium lights, mercury lights etc. 	<p>Back up while visually checking the vehicle's surroundings. (Use the monitor again once conditions have been improved.)</p> <p>The procedure for adjusting the picture quality of the rear view monitor system is the same as the procedure for adjusting the screen. (→P.25)</p>
The image is blurry	Dirt or foreign matter (such as water droplets, snow, mud etc.) is adhering to the camera.	Flush the camera with a large quantity of water and wipe the camera lens clean with a soft and wet cloth.
The image is out of alignment	The camera or surrounding area has received a strong impact.	Have the vehicle inspected by any Toyota retailer or Toyota authorized repairer, or any reliable repairer.

Symptom	Likely cause	Solution
The fixed guide lines are very far out of alignment	The camera position is out of alignment.	Have the vehicle inspected by any Toyota retailer or Toyota authorized repairer, or any reliable repairer.
	<ul style="list-style-type: none"> • The vehicle is tilted (there is a heavy load on the vehicle, tyre pressure is low due to a tyre puncture, etc.) • The vehicle is used on an incline. 	<p>If this happens due to these causes, it does not indicate a malfunction.</p> <p>Back up while visually checking the vehicle's surroundings.</p>

- 6-1. Phone operation (Hands-free system for cellular phones)**
 - Quick reference106
 - Some basics107
 - Placing a call using the Bluetooth® hands-free system111
 - Receiving a call using the Bluetooth® hands-free system115
 - Talking on the Bluetooth® hands-free system115
 - Bluetooth® phone message function117
- 6-2. Setup**
 - Phone settings122
- 6-3. What to do if...**
 - Troubleshooting131

Quick reference

Phone screen operation

The phone top screen can be reached by the following methods:

- ▶ From the "PHONE" button
 - 1 Press the "PHONE" button.
- ▶ From the "MENU" button
 - 1 Press the "MENU" button, then select "Phone".

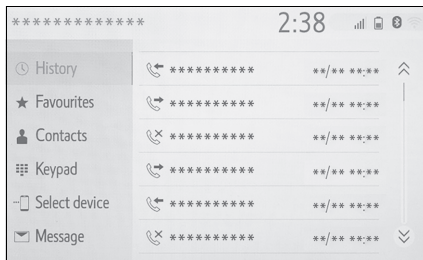

Bluetooth® hands-free system operation

The following functions can be used on phone operation:

- Registering/connecting a Bluetooth® device (→P.28)
- Placing a call using the Bluetooth® hands-free system (→P.111)
- Receiving a call using the Bluetooth® hands-free system (→P.115)
- Talking on the Bluetooth® hands-free system (→P.115)

Message function

The following function can be used on message function:

- Using the Bluetooth® phone message function (→P.117)

Setting up a phone

The following settings can be made in system:

- Phone settings (→P.122)
- Bluetooth® settings (→P.32)

Some basics

The hands-free system enables calls to be made and received without having to take your hands off the steering wheel.

This system supports Bluetooth®. Bluetooth® is a wireless data system that enables cellular phones to be used without being connected by a cable or placed in a cradle.

The operating procedure of the phone is explained here.

When an Apple CarPlay connection is established, phone functions will be performed by Apple CarPlay instead of the hands-free system.

- This system is not guaranteed to operate with all Bluetooth® devices.
- If your cellular phone does not support Bluetooth®, this system cannot function.
- In the following conditions, the system may not function:
 - The cellular phone is turned off.
 - The current position is outside the communication area.
 - The cellular phone is not connected.
 - The cellular phone has a low battery.
- When using the hands-free system or Bluetooth® audio and Wi-Fi® functions at the same time, the following problems may occur:
 - The Bluetooth® connection may be cut.
 - Noise may be heard on the Blue-

tooth® audio playback.

- A noise may be heard during phone calls.
- Bluetooth® uses the 2.4 GHz frequency band. If both a Wi-Fi® connection and Bluetooth® connection are being used simultaneously, each connection may be affected.
- If a Bluetooth® device is attempting to connect to the vehicle while another device is connected as a Bluetooth® audio device or connected using the hands-free system or Miracast®, the communication speed may decrease or malfunctions may occur, such as image distortion or audio skipping. If a Bluetooth® device is connected to the system, the interference it may cause will be reduced. When carrying a device with its Bluetooth® connection enabled, make sure to register it to the system and connect it or disable its Bluetooth® function.
- When a device is connected via Bluetooth®, the Bluetooth® icon on the status bar will be displayed in blue. (→P.14)



WARNING

- While driving, do not operate a cellular phone.
- Your audio unit is fitted with Bluetooth® antennas. People with implantable cardiac pacemakers, cardiac resynchronization therapy-pacemakers or implantable cardioverter defibrillators should maintain a reasonable distance between themselves and the Bluetooth® antennas. The radio waves may affect the operation of such devices.



WARNING

- Before using Bluetooth® devices, users of any electrical medical device other than implantable cardiac pacemakers, cardiac resynchronization therapy-pacemakers or implantable cardioverter defibrillators should consult the manufacturer of the device for information about its operation under the influence of radio waves. Radio waves could have unexpected effects on the operation of such medical devices.



NOTICE

- Do not leave your cellular phone in the vehicle. The temperature inside may rise to a level that could damage the phone.

Registering/Connecting a Bluetooth® phone

To use the hands-free system for cellular phones, it is necessary to register a cellular phone with the system. (→P.28)

■ **Connecting a Bluetooth® device**

- ▶ Registering an additional device
 - 1 Display the phone top screen. (→P.106)
 - 2 Select “Select device”.
 - 3 Select “Add device”.
- When another Bluetooth® device is connected, a confirmation screen will be displayed. To disconnect the Bluetooth® device,

select “Yes”.

- 4 Follow the steps in “Registering a Bluetooth® phone for the first time” from step 5. (→P.28)

▶ **Selecting a registered device**

- 1 Display the phone top screen. (→P.106)
 - 2 Select “Select device”.
 - 3 Select the desired device to be connected.
 - 4 Check that a confirmation screen is displayed when the connection is complete.
- If an error message is displayed, follow the guidance on the screen to try again.

■ **Bluetooth® phone condition display**

The condition of the Bluetooth® phone appears on the upper right side of the screen. (→P.14)

Using the phone switch/microphone

■ **Steering switch**

By pressing the phone switch, a call can be received or ended without taking your hands off the steering wheel.

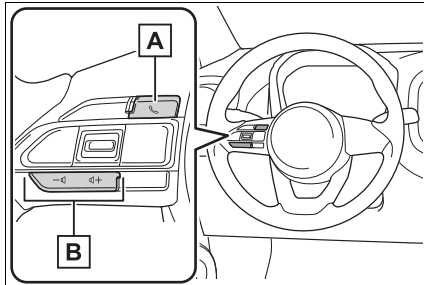
**A** Phone switch

- If the switch is pressed when the phone screen is not displayed, the screen is displayed on the multi-information display or system screen. The phone screen can be setup to be displayed on the multi-information display or system screen. (→P.123)
- If the switch is pressed during a call, the call will end.
- If the switch is pressed when an incoming call is received, the call will be answered.
- If the switch is pressed during a call when a separate incoming call is waiting, the waiting call will be answered.
- If the switch is pressed when an Apple CarPlay connection is established, the Apple CarPlay phone application will be displayed on the system screen.

B Volume control switch

Press to adjust the volume.

■ Microphone

The microphone is used when talking on the phone.

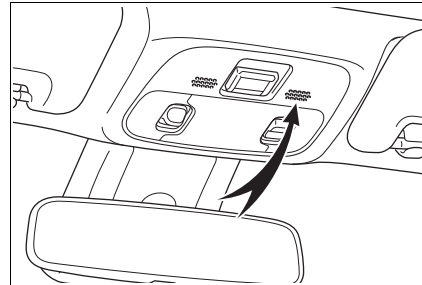

- The other party's voice will be heard from the front speakers. The audio/visual system will be muted during phone calls or when hands-free speech commands are used.
- Talk alternately with the other party on the phone. If both parties speak at the same time, the other party may not hear what has been said. (This is not a malfunction.)
- Keep call volume down. Otherwise, the other party's voice may be audible outside the vehicle and voice echo may increase. When talking on the phone, speak clearly towards the microphone.
- The other party may not hear you clearly when:
 - Driving on an unpaved road. (Making excessive traffic noise.)
 - Driving at high speeds.
 - The windows are open.
 - The air conditioning vents are pointed towards the microphone.
 - The sound of the air conditioning fan is loud.
 - There is a negative effect on sound quality due to the phone and/or network being used.

**NOTICE**

- Do not touch and put a sharp object to the microphone. It may cause failure.

Speech command system

Press this switch to operate the speech command system.

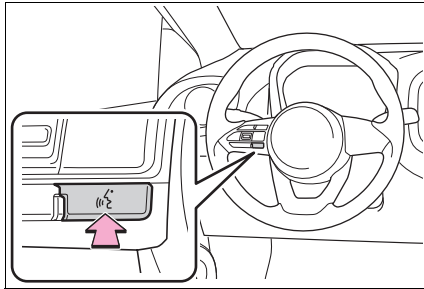

- The speech command system and its list of commands can be operated. (→P.90)

About the contacts in the contact list

- The following data is stored for every registered phone. When another phone is connected, the following registered data cannot be read:
 - Contact data
 - Call history data
 - Favourites data
 - Image data
 - All phone settings
 - Message settings
- When a phone's registration is deleted, the above-mentioned data is also deleted.

When selling or disposing of the vehicle

A lot of personal data is registered

when the hands-free system is used. When selling or disposing of the vehicle, initialize the data. (→P.51)

- The following data in the system can be initialized:
 - Contact data
 - Call history data
 - Favourites data
 - Image data
 - All phone settings
 - Message settings
- Once initialized, the data and settings will be erased. Pay much attention when initializing the data.

Placing a call using the Bluetooth® hands-free system

After a Bluetooth® phone has been registered, a call can be made using the hands-free system. There are several methods by which a call can be made, as described below.

Calling methods on the Bluetooth® phone

- 1 Display the phone top screen. (→P.106)
- 2 Select the desired method to call from.

■ Calling methods from phone screen

- By call history (→P.111)
- By favourites (→P.112)
- By contacts (→P.112)
- By keypad (→P.113)
- By message (→P.120)

■ Also the following lists are available from each function's screen

- By speech command system (→P.110)
- SOS* (→P.113)
- By home screen (→P.114)

*: Models with navigation function

By call history

Up to 45 of the latest call history items (missed, incoming and outgoing) can be selected.

- 1 Display the phone top screen. (→P.106)
- 2 Select "History" and select the desired contact.
 - If the contact which is not registered on the contact list is selected, the name is displayed as "Unknown contact". In this case, select the number to make a call.
- 3 Check that the dialing screen is displayed.

- The icons of call type are displayed.

 : Missed call

 : Incoming call

 : Outgoing call

- When making a call to the same number continuously, only the most recent call is listed in call history.
- When a phone number registered in the contact list is received, the name is displayed.
- Number-withheld calls are also memorized in the system.
- International phone calls may not be made depending on the type of Bluetooth® phone you have.
- The list should group together consecutive entries with the same phone number and same call type. For example, two calls from John's mobile would be displayed as follows: John (2)

By favourites list

Calls can be made using registered contacts which can be selected from a contact list. (→P.128)

- 1** Display the phone top screen. (→P.106)
- 2** Select “Favourites” and select the desired contact.
- 3** Select the desired number.
- 4** Check that the dialing screen is displayed.

By contacts list

Calls can be made by using contact data which is transferred from a registered cellular phone. (→P.124)

Up to 5000 contacts (maximum of 4 phone numbers and e-mail addresses per contact) can be registered in the contact list.

- 1** Display the phone top screen. (→P.106)
- 2** Select “Contacts” and select the desired contact.
- 3** Select the desired number.

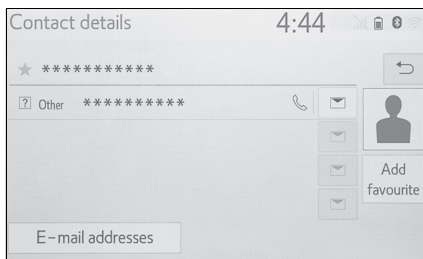

“Add favourite”/“Remove favourite”:
Select to register/remove the contact in the favourites list. (→P.128, 129)

“E-mail addresses”: Select to display all registered e-mail addresses for the contact.

- 4** Check that the dialing screen is displayed.

When the contact list is empty

■ **For PBAP compatible Bluetooth® phones when “Automatic transfer” is set to on (→P.125)**

- Contacts are transferred automatically.

■ **For PBAP compatible Bluetooth® phones when “Automatic transfer” is set to off (→P.125)**

- 1** Select the desired item.

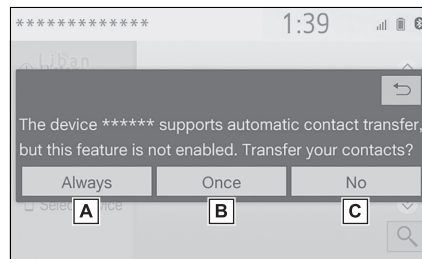

A Select to always transfer all the contacts from a connected cellular phone automatically.

B Select to transfer all the contacts from a connected cellular phone only once.

C Select to cancel transferring.

- 2 Check that a confirmation screen is displayed when the operation is complete.

■ **For PBAP incompatible but OPP compatible Bluetooth® phones**

- 1 Select the desired item.

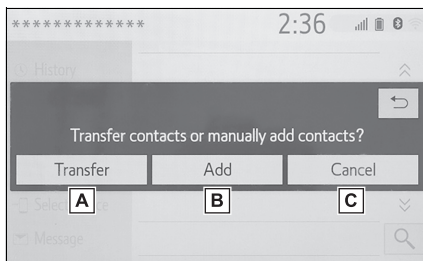

- A** Select to always transfer all the contacts from a connected cellular phone automatically.
- B** Select to add a new contact manually.
Follow the steps in “Registering a new contact to the contacts list” from step 2. (→P.127)
- C** Select to cancel transferring.

- If your cellular phone is neither PBAP nor OPP compatible, the contacts cannot be transferred using Bluetooth®. But the contacts can be transferred from USB device. (→P.126)
- Depending on the type of Bluetooth® phone:
 - It may be necessary to perform additional steps on the phone when transferring contact data.
 - The registered image in the contact list may not transfer depending on the type of Bluetooth® phone connected.

By keypad

- 1 Display the phone top screen. (→P.106)
- 2 Select “Keypad” and enter the phone number.
- 3 Select or press the switch on the steering wheel.
- 4 Check that the dialing screen is displayed.

- Depending on the type of Bluetooth® phone being connected, it may be necessary to perform additional steps on the phone.

SOS*

- *: Models with navigation function

112 emergency call support

This feature is used to make a 112 emergency call. This function is not available when the hands-free system is not connected.

The call has to be placed from a country where 112 is available.

- 1 Display the phone top screen. (→P.106)
 - 2 Select “Keypad” and select “SOS”.
 - 3 Select “112”.
 - 4 Check that the dialing screen is displayed.
- The current location of the vehicle is displayed on the screen.

Roadside assist

This feature is used to make a call to Toyota roadside assist service.

The call has to be placed from a country where Toyota roadside assist service is available.

To use this function, it is necessary to register a country. (→P.130)

- 1** Display the phone top screen. (→P.106)
 - 2** Select “Favourites” and select “Toyota assistance”.
 - 3** Select .
 - 4** Check that the dialing screen is displayed.
- The current location of the vehicle is displayed on the screen.

- The contact cannot be registered at the home screen while driving.

By home screen

- 1** Display the home screen. (→P.21)
- 2** Select the desired contact.
- 3** Check that the dialing screen is displayed.

Registering a new contact

- 1** Select and hold the screen button to add a contact.
- 2** Select the desired contact.
- 3** Select the desired number.

- If there is no contact in the contacts list, the contacts cannot be registered at the home screen.

Receiving a call using the Bluetooth® hands-free system

When a call is received, the following screen is displayed with a sound.

Incoming calls

- Select "Answer" or press the  switch on the steering wheel to talk on the phone.

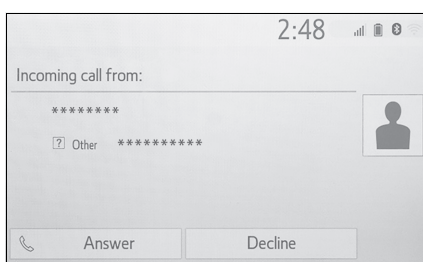

"Decline": Select to refuse to receive the call.

To adjust the volume of a received call: Turn the "POWER VOLUME" knob, or use the volume control switch on the steering wheel.

- During international phone calls, the other party's name or number may not be displayed correctly depending on the type of cellular phone you have.
- The incoming call display mode can be set. (→P.123)
- The ringtone that has been set in the sound settings screen can be heard when there is an incoming call. Depending on the type of Bluetooth® phone, both the system and Bluetooth® phone may ring simultaneously when there is an incoming call. (→P.122)

Talking on the Bluetooth® hands-free system

While talking on the phone, the following screen is displayed. The operations outlined below can be performed on this screen.

Call screen operation

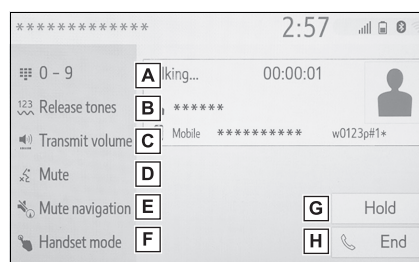

- Select to display the keypad to send tones. (→P.116)
- Select to send tones. This button only appears when a number that contains a (w) is dialed in hands-free mode. (→P.116)
- Select to adjust your voice volume that the other party hears from their speaker. (→P.116)
- Select to mute your voice to the other party.
- Select to mute the Navigation route guidance during a phone call.*

F Select to change handset modes between hands-free and cellular phone.

G Select to put a call on hold. To cancel this function, select “Activate”.

H Select to hang up the phone.

*: Models with navigation function

- When cellular phone call is changed to hands-free call, the hands-free screen will be displayed and its functions can be operated on the screen.
- Changing between cellular phone call and hands-free call can be performed by operating the cellular phone directly.
- Transferring methods and operations will be different depending on the type of cellular phone you have.
- For the operation of the cellular phone, see the manual that comes with it.

Sending tones

■ By keypad

This operation cannot be performed while driving.

- 1 Select “0-9”.
- 2 Enter the desired number.

■ By selecting “Release tones”

“Release tones” appear when a continuous tone signal(s) containing a (w) is registered in the contact list.

This operation can be performed while driving.

- 1 Select “Release tones”.

● A continuous tone signal is a character string that consists of numbers and the characters “p” or “w”. (e.g. 056133w0123p#1)

● When the “p” pause tone is used, the tone data up until the next pause tone will be automatically sent after 2 seconds have elapsed. When the “w” pause tone is used, the tone data up until the next pause tone will be automatically sent after a user operation is performed.

● Release tones can be used when automated operation of a phone based service such as an answering machine or bank phone service is desired. A phone number with continuous tone signals can be registered in the contact list.

Transmit volume setting

- 1 Select “Transmit volume”.
- 2 Select the desired level for the transmit volume.
- 3 Press the  button to display previous screen.

● The sound quality of the voice heard from the other party’s speaker may be negatively impacted.

● “Transmit volume” is dimmed when mute is on.

Switching calls while a call is in progress

- When there are no calls on hold during a call: “Hold” is displayed. When selected, the current call is placed on hold.
- When there is no current call, but there is a call on hold: “Activate”

is displayed. When selected, the system switches to the call that was on hold.

- When there is another call on hold during a call: “Swap calls” is displayed. When selected, the current call is placed on hold, and the system switches to the call that was on hold.

- This function may not be available depending on the type of cellular phone.

Incoming call waiting

When a call is interrupted by a third party while talking, the incoming call screen is displayed.

- 1 Select “Answer” or press the  switch on the steering wheel to start talking with the other party.

“Decline”: Select to refuse to receive the call.

Changing parties

- 1 Select “Swap calls”.
- Each time “Swap calls” is selected during an interrupted call, the party who is on hold will be switched.

- This function may not be available depending on the type of cellular phone.

Bluetooth® phone message function

Received messages can be forwarded from the connected Bluetooth® phone, enabling checking and replying using the system.

Depending on the type of Bluetooth® phone connected, received messages may not be transferred to the system.

If the phone does not support the message function, this function cannot be used.

Displaying the message screen

- 1 Display the phone top screen. (→P.106)
- 2 Select “Message”.
- A confirmation message appears when the “Automatic message transfer” function is set to off (→P.129), select “Yes”.
- 3 Check that the message screen is displayed.

“Phone”: Select to change to phone mode.

- The account name is displayed on the left side of screen.
- Account names are the names of the accounts that exist on the currently connected phone.
- The following functions can be

used on message function:

- Receiving a message (→P.118)
- Checking received messages (→P.118)
- Checking sent messages (→P.119)
- Create new message (→P.119)
- Replying to a message (quick reply) (→P.120)
- Calling the message sender (→P.120)
- Message settings (→P.129)

Receiving a message

When an e-mail/SMS/MMS is received, the incoming message screen pops up with sound and is ready to be operated on the screen.

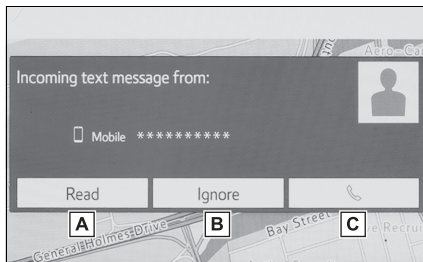

- A** Select to check the message.
- B** Select to not open the message.
- C** Select to call the message sender.

- Depending on the cellular phone used for receiving messages, or its registration status with the system, some information may not be displayed.
- The pop-up screen is separately available for incoming e-mail and SMS/MMS messages under the following conditions:
E-mail:

- “Incoming E-mail display” is set to “Full screen”. (→P.123)
- “E-mail notification pop-up” is set to on. (→P.123)

SMS/MMS:

- “Incoming SMS/MMS display” is set to “Full screen”. (→P.123)
- “SMS/MMS notification pop-up” is set to on. (→P.123)

Checking received messages

- 1 Display the message screen. (→P.117)
- 2 Select a desired account name.
- 3 Select the desired message from the list.
- 4 Check that the message is displayed.

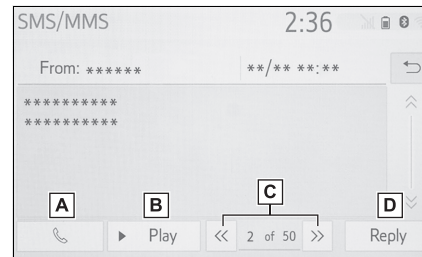

- A** Select to call the message sender.
- B** Select to have messages read out.
To cancel this function, select “Stop”.
When “Automatic message readout” is set to on, messages will be automatically read out. (→P.129)

C Select to display the previous or next message.

D Select to reply the message.
(→P.120)

- Depending on the type of Bluetooth® phone being connected, it may be necessary to perform additional steps on the phone.
- Messages are displayed in the appropriate connected Bluetooth® phone's registered mail address folder. Select the desired folder to be displayed.
- Only received messages on the connected Bluetooth® phone can be displayed.
- The text of the message is not displayed while driving.
- Turn the "POWER VOLUME" knob, or use the volume control switch on the steering wheel to adjust the message read out volume.
- "Subject:" field is not shown on SMS case.
- E-mail only: Select "Mark unread" or "Mark read" to mark mail unread or read on the message screen. This function is available when "Update message read status on phone" is set to on. (→P.129)

Checking sent messages

- 1 Display the message screen.
(→P.117)
- 2 Select the desired outbox from the list displayed on the left side of the screen.
- 3 Select the desired message from the list.

- 4 Check that the message is displayed.

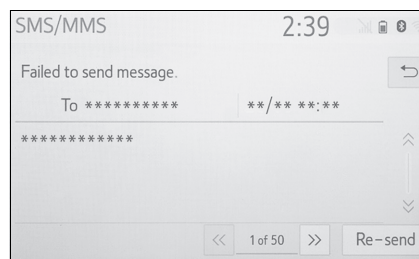

"Re-send": Select to re-send the message. This switch is displayed if sending the text message has failed.

Create a new message

The message type which can be created is SMS only.

- 1 Display the phone top screen.
(→P.106)
- ▶ From the contact or favourite screen
 - 2 Select "Contacts" or "Favourite".
 - 3 Select desired contact.
- ▶ From the call history screen
 - 2 Select "History".
 - 3 Select a contact not yet registered in the contact list.
- 4 Select  corresponding to the desired number.
- 5 Select "New".
- 6 Enter the message and then select "OK".
- 7 Select "Send".

"Cancel": Select to cancel sending the message.

- While the message is being sent,

a sending message screen is displayed.

- 8 Check that a confirmation screen is displayed when the operation is complete.
- If an error message is displayed, follow the guidance on the screen to try again.

- The short messages can contain up to 160 characters. The divided text will be sent when the message body exceed over 160 characters.
- Depending on the type of Bluetooth® phone used for receiving messages, reply function may not be used.

Replying to a message (quick reply)

15 messages have already been stored.

- 1 Display the message screen. (→P.117)
- 2 Select a desired account name that is displayed on the left side of screen.
- 3 Select the desired message from the list.
- 4 Select "Reply".
- 5 Select "Quick message".
- 6 Select the desired message.

: Select to edit the message. (→P.120)

- 7 Select "Send".

"Cancel": Select to cancel sending the message.

- While the message is being sent,

a sending message screen is displayed.

- 8 Check that a confirmation screen is displayed when the operation is complete.
- If an error message is displayed, follow the guidance on the screen to try again.

- Depending on the type of Bluetooth® phone, reply function is not available.

Editing quick reply messages

This operation cannot be performed while driving.

- 1 Select "Reply".
- 2 Select "Quick message".
- 3 Select  corresponding to the desired message to edit.
- 4 Select "OK" when editing is completed.

- To reset the edit quick reply messages, select "Default".
- Quick message 1 ("I am driving and will arrive in approximately [##] minutes.")*: This message cannot be edited and will automatically fill in [##] with the navigation calculated estimated time of arrival on the confirm message screen. If there are waypoints set, [##] to the next waypoint will be shown. If there is no route currently set in the navigation system, quick message 1 cannot be selected.
- *: Models with navigation function



Calling the message sender

Calls can be made to an e-

mail/SMS/MMS message sender's phone number.

This operation can be performed while driving.

■ Calling from e-mail/SMS/MMS message display

- 1 Display the message screen. (→P.117)
- 2 Select a desired account name that is displayed on the left side of screen.
- 3 Select the desired message.
- 4 Select , or press the  switch on the steering wheel.
 - If there are 2 or more phone numbers, select the desired number.
- 5 Check that the dialing screen is displayed.

■ Calling from a number within a message

Calls can be made to a number identified in a message's text area. This operation cannot be performed while driving.

- 1 Display the message screen. (→P.117)
- 2 Select a desired account name that is displayed on the left side of screen.
- 3 Select the desired message.

- 4 Select the text area.

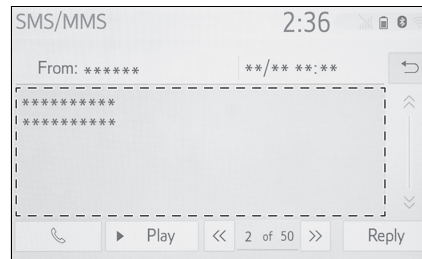

- Identified phone numbers contained in the message are displayed in blue text.
- 5 Select the desired number.
 - 6 Check that the dialing screen is displayed.
- A series of numbers may be recognized as a phone number. Additionally, some phone numbers may not be recognized, such as those for other countries.

■ Calling from the incoming message screen

→P.118

Phone settings

Displaying the phone settings screen

- 1 Press the "SETUP" button.

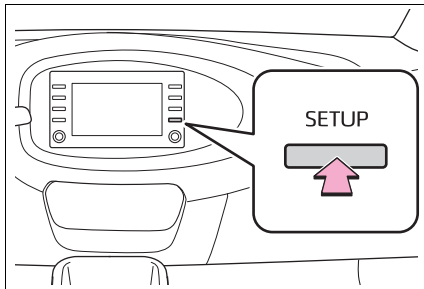

- 2 Select "Phone".
- 3 Select the desired item to be set.

Phone settings screen

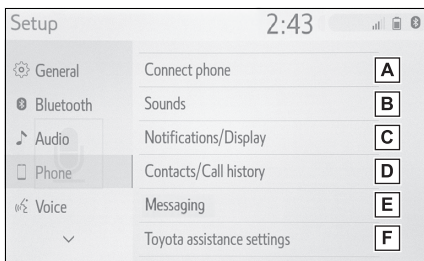

- A** Connecting a Bluetooth® device and editing the Bluetooth® device information (→P.33, 35)
- B** Sound settings (→P.122)
- C** Notification/display settings (→P.123)
- D** Contact/call history settings (→P.124)

E Message settings (→P.129)

F Toyota assistance settings* (→P.130)

*: Models with navigation function only

Sounds settings screen

The call and ringtone volume can be adjusted. A ringtone can be selected.

- 1 Display the phone settings screen. (→P.122)
- 2 Select "Sounds".
- 3 Select the desired item to be set.

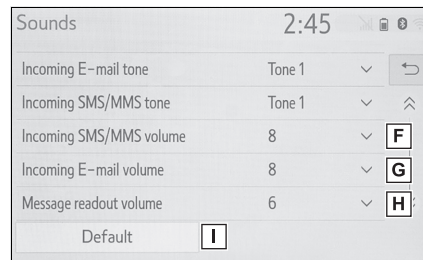
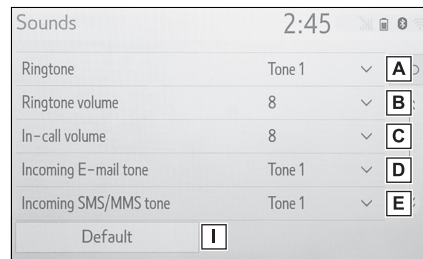

- A** Select to set the desired ringtone.
- B** Select "-" or "+" to adjust the ringtone volume.
- C** Select "-" or "+" to adjust the

default volume of the other party's voice.

- D** Select to set the desired incoming e-mail tone.
- E** Select to set the desired incoming SMS/MMS tone.
- F** Select “-” or “+” to adjust the incoming SMS/MMS tone volume.
- G** Select “-” or “+” to adjust the incoming e-mail tone volume.
- H** Select “-” or “+” to adjust the message readout volume.
- I** Select to reset all setup items.

- Depending on the type of phone, certain functions may not be available.

Notifications/Display settings screen

- 1 Display the phone settings screen. (→P.122)
- 2 Select “Notifications/Display”.

- 3 Select the desired item to be set.

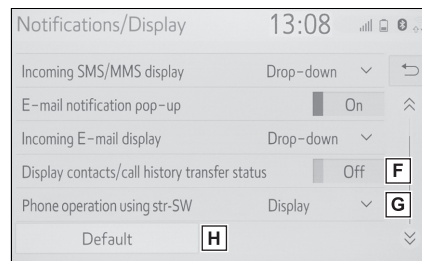
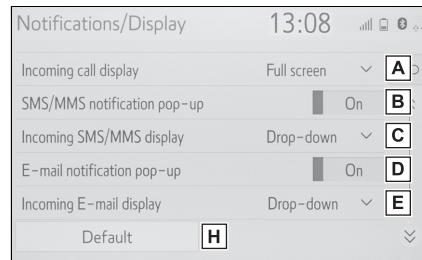

- A** Select to change the incoming call display.

“Full screen”: When a call is received, the incoming call screen is displayed and can be operated on the screen.

“Drop-down”: A message is displayed at the top of the screen.

- B** Select to set the SMS/MMS notification pop-up on/off.

- C** Select to change the incoming SMS/MMS display.

“Full screen”: When an SMS/MMS message is received, the incoming SMS/MMS display screen is displayed and can be operated on the screen.

“Drop-down”: When an SMS/MMS message is received, a message is displayed at the top of the screen.

- D** Select to set the e-mail notification pop-up on/off.

- E** Select to change the incoming e-mail display.

“Full screen”: When an e-mail is received, the incoming e-mail display screen is the displayed and can be operated on the screen.

“Drop-down”: When an e-mail is received, a message is displayed at the top of the screen.

- F** Select to set display of the contact/history transfer completion message on/off.

- G** The phone top screen can be set to be displayed on the multi-information display or system screen.

- H** Select to reset all setup items.

● Depending on the phone, these functions may not be available.

Contact/Call history settings screen

Contacts can be transferred from a Bluetooth® phone to this system. Contacts and favourites can be added, edited and deleted. Also, the call history can be deleted.

- 1 Display the phone settings screen. (→P.122)
- 2 Select “Contacts/Call history”.

- 3 Select the desired item to be set.

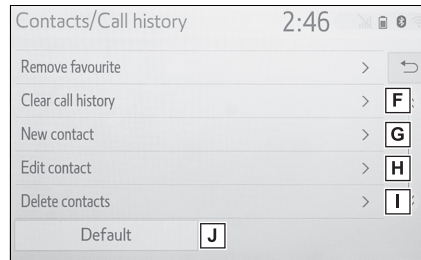
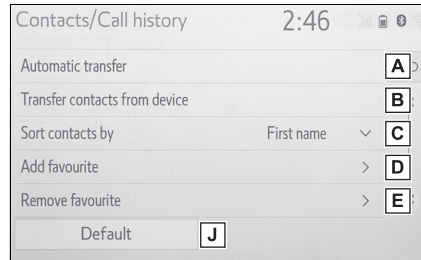

- A** For PBAP compatible Bluetooth® phones: Select to change the contact/history transfer settings. (→P.125)
- B** Select to update contacts from the connected phone or a USB memory. (→P.126)
- C** Select to sort contacts by the first name or last name field.
- D** Select to add contacts to the favourites list. (→P.128)
- E** Select to delete contacts from the favourites list. (→P.128)
- F** Select to clear the call history.*
- G** Select to add new contacts to the contact list.* (→P.127)

- H** Select to edit contacts in the contact list.* (→P.127)
- I** Select to delete contacts from the contact list.* (→P.128)
- J** Select to reset all setup items.

*: For PBAP compatible Bluetooth® phones, this function is available when “Automatic transfer” is set to off. (→P.125)

- Depending on the type of phone, certain functions may not be available.
- Contact data is managed independently for every registered phone. When one phone is connected, another phone’s registered data cannot be read.

Setting automatic contact/history transfer

The automatic contact/history function is available for PBAP compatible Bluetooth® phones only.

- 1 Select “Automatic transfer”.
- 2 Select the desired item to be set.

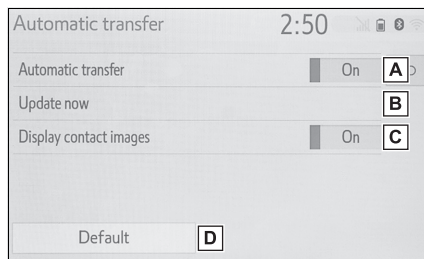

- A** Select to set automatic contact/history transfer on/off. When set to on, the phone’s

contact data and history are automatically transferred.

- B** Select to update contacts from the connected phone. (→P.125)
- C** Select to set the transferred contact image display on/off.
- D** Select to reset all setup items.

■ Updating contacts from phone

- 1 Select “Update now”.
- Contacts are transferred automatically.
- 2 Check that a confirmation screen is displayed when the operation is complete.
- This operation may be unnecessary depending on the type of cellular phone.
 - If another Bluetooth® device is connected when transferring contact data, depending on the phone, the connected Bluetooth® device may need to be disconnected.
 - Depending on the type of Bluetooth® phone being connected, it may be necessary to perform additional steps on the phone.

■ Updating the contacts in a different way (from the call history screen)*

- 1 Display the phone top screen. (→P.106)

- 2 Select "History" and select a contact not yet registered in the contact list.
- 3 Select "Update contact".
- 4 Select the desired contact.
- 5 Select a phone type for the phone number.

*: For PBAP compatible Bluetooth[®] phones, this function is available when "Automatic transfer" is set to off. (→P.125)

- When an Android Auto connection is established, this function will be unavailable.

Transferring contacts from device

From phone (OPP compatible Bluetooth[®] phones only)

- 1 Select "Transfer contacts from device".
- 2 Select "From phone (Bluetooth)".
 - ▶ When the contact is not registered
- 3 Transfer the contact data to the system using a Bluetooth[®] phone.
 - This operation may be unnecessary depending on the type of cellular phone.
 - To cancel this function, select "Cancel".

- 4 Check that a confirmation screen is displayed when the operation is complete.

▶ When the contact is registered

- 3 Select "Replace contacts" or "Add contact".

"Replace contacts": Select to transfer the contact from the connected cellular phone and replace the current one.

"Add contact": Select to transfer the desired contact data from the connected cellular phone to add to the current one.

- 4 Transfer the contact data to the system using a Bluetooth[®] phone.

- This operation may be unnecessary depending on the type of cellular phone.
- To cancel this function, select "Cancel".

- 5 Check that a confirmation screen is displayed when the operation is complete.

From USB device

Backed-up contact data ("vCard" formatted) can be transferred from USB device or Bluetooth[®] phone connected via USB to this system.

- 1 Connect a USB device. (→P.58)
- 2 Select "Transfer contacts from device".
- 3 Select "From USB".
- 4 Select "USB 1" or "USB 2" when the multiple USB devices are connected.

- If a USB device is connected, skip this procedure.
- ▶ When the contact is not registered
- 5 Select a desired file from vCard file list.
- 6 Check that a confirmation screen is displayed when the operation is complete.
- ▶ When the contact is registered
- 5 Select "Replace contacts" or "Add contact".

"Replace contacts": Select to transfer the contact from the connected USB device or Bluetooth® phone and replace the current one.

"Add contact": Select to transfer the desired contact data from the connected USB device or Bluetooth® phone to add to the current one.

- 6 Select a desired file from vCard file list.
- 7 Check that a confirmation screen is displayed when the operation is complete.

-
- Depending type of phone used and number of files, it may take time to display vCard file lists and download contacts.
 - Downloading may not complete correctly in the following cases:
 - If the engine switch is turned off during downloading.
 - If the USB device or Bluetooth® phone is removed before downloading is complete.

Registering a new contact to the contact list

New contact data can be registered.

Up to 4 numbers per person can be registered. For PBAP compatible Bluetooth® phones, this function is available when "Automatic transfer" is set to off. (→P.124)

- 1 Select "New contact".
- 2 Enter the name and select "OK".
- 3 Enter the phone number and select "OK".
- 4 Select the phone type for the phone number.
- 5 To add another number to this contact, select "Yes".

Registering a new contact in a different way (from the call history screen)

- 1 Display the phone top screen. (→P.106)
- 2 Select "History" and select a contact not yet registered in the contact list.
- 3 Select "Add to contacts".
- 4 Follow the steps in "Registering a new contact to the contact list" from step 2. (→P.127)

Editing the contact data

For PBAP compatible Bluetooth® phones, this function is available when "Automatic transfer" is set to

off. (→P.124)

- 1 Select "Edit contact".
- 2 Select the desired contact.
- 3 Select  corresponding to the desired name or number.
 - ▶ For editing the name
- 4 Follow the steps in "Registering a new contact to the contact list" from step 2. (→P.127)
 - ▶ For editing the number
- 4 Follow the steps in "Registering a new contact to the contact list" from step 3. (→P.127)

Deleting the contact data

For PBAP compatible Bluetooth® phones, this function is available when "Automatic transfer" is set to off. (→P.124)

- 1 Select "Delete contacts".
- 2 Select the desired contact and select "Delete".
- 3 Select "Yes" when the confirmation screen appears.

- Multiple data can be selected and deleted at the same time.
- When a Bluetooth® phone is deleted, the contact data will be deleted at the same time.

Favourites list setting

Up to 15 contacts (maximum of 4 numbers per contact) can be registered in the favourites list.

Registering the contacts in the favourites list

- 1 Select "Add favourite".
- 2 Select the desired contact to add to the favourites list.
 - Dimmed contacts are already stored as a favourites.
 - When 15 contacts have already been registered to the favourites list, a registered contact needs to be replaced. Select "Yes" when the confirmation screen appears and select the contact to be replaced.
- 3 Check that a confirmation screen is displayed when the operation is complete.

Registering contacts in the favourites list in a different way (from the contact details screen)

- 1 Display the phone top screen. (→P.106)
- 2 Select "Contacts" and select the desired contact.
- 3 Select "Add favourite".
- 4 Check that a confirmation screen is displayed when the operation is complete.

Deleting the contacts in the favourites list

- 1 Select "Remove favourite".
- 2 Select the desired contacts and select "Remove".

- 3 Select "Yes" when the confirmation screen appears.
 - 4 Check that a confirmation screen is displayed when the operation is complete.
- **Deleting contacts in the favourites list in a different way (from the contact details screen)**
- 1 Display the phone top screen. (→P.106)
 - 2 Select "Favourites" or "Contacts" and select the desired contact to delete.
 - 3 Select "Remove favourite".
 - 4 Select "Yes" when the confirmation screen appears.
 - 5 Check that a confirmation screen is displayed when the operation is complete.

Message settings screen

- 1 Display the phone settings screen. (→P.122)
- 2 Select "Messaging".
- 3 Select the desired item to be set.

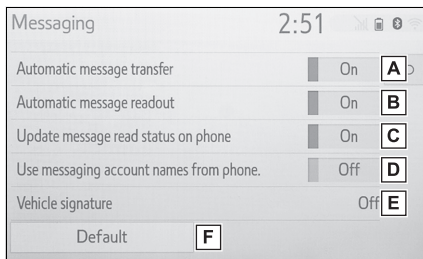

- A Select to set automatic message transfer on/off.
- B Select to set automatic message readout on/off.
- C Select to set updating message read status on phone on/off.
- D Select to set display of messaging account names on the message screen on/off. When set to on, messaging account names used on the cellular phone will be displayed.
- E Select to change the vehicle signature settings. (→P.129)
- F Select to reset all setup items.

● Depending on the phone, these functions may not be available.

Vehicle signature settings

- 1 Select "Vehicle signature".
- 2 Select the desired item to be set.

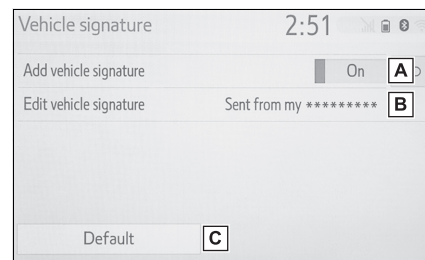

- A Select to set adding the vehicle signature to outgoing messages on/off.

B Select to edit the vehicle signature. (→P.130)

C Select to reset all setup items.

■ Editing vehicle signature

- 1 Select “Edit vehicle signature”.
- 2 Enter desired signature and select “OK”.
- 3 Select “OK” on the preview screen. “Edit again”: Select to edit the signature again.

“Toyota assistance settings” screen*

*: Models with navigation function

Registering a country

- 1 Display the phone settings screen. (→P.122)
- 2 Select “Toyota assistance settings”.
- 3 Select the country.
- 4 Check that a confirmation screen is displayed when the operation is complete.

Registering a country in a different way

- 1 Display the phone top screen. (→P.106)
- 2 Select “Favourites”.
- 3 Select “Toyota assistance”.

- 4 Select the registered country's screen button.

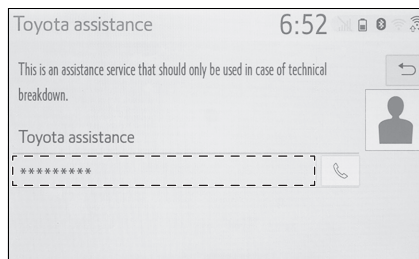

- 5 Select the country.
- 6 Select “Yes” when the confirmation screen appears.

Troubleshooting

If there is a problem with the hands-free system or a Bluetooth® device, first check the table below.

Troubleshooting
When using the hands-free system with a Bluetooth® device

The hands-free system or Bluetooth® device does not work.

- The Bluetooth® version of the connected cellular phone may be older than the specified version.

Use a cellular phone with Bluetooth® version 2.0 or higher (recommended: Ver. 4.2) (→P.31)

When registering/connecting a cellular phone

A cellular phone cannot be registered.

- An incorrect passcode was entered on the cellular phone.

Enter the correct passcode on the cellular phone.

- The registration operation has not been completed on the cellular phone side.

Complete the registration operation on the cellular phone (approve registration on the phone).

- Old registration information remains on either this system or the cellular phone.

Delete the existing registration information from both this system and the cellular phone, then register the cellular phone you wish to connect to this system. (→P.34)

A Bluetooth® connection cannot be made.

- Another Bluetooth® device is already connected.

Manually connect the cellular phone you wish to use to this system. (→P.33)

- Bluetooth® function is not enabled on the cellular phone.

Enable the Bluetooth® function on the cellular phone.

- Automatic Bluetooth® connection on this system is set to off.

Set automatic Bluetooth® connection on this system to on when the engine switch is in ACC or ON. (→P.37)

■ **Preferred device settings function on this system is set to on.**

Set preferred device settings function on this system to off. (→P.37)

Set the desired cellular phone to the highest automatic connection priority. (→P.38)

A cellular phone cannot be connected.

■ **Bluetooth® function is not enabled on the cellular phone.**

Enable the Bluetooth® function on the cellular phone.

■ **Old registration information remains on either this system or the cellular phone.**

Delete the existing registration information from both this system and the cellular phone, then register the cellular phone you wish to connect to this system. (→P.34)

When making/receiving a call

A call cannot be made/received.

■ **Your vehicle is out of the service area.**

Move to where  no longer appears on the display.

When using the phonebook

Phonebook data cannot be transferred manually/automatically.

■ **Automatic contact transfer function on this system is set to off.**

Set automatic contact transfer function on this system to on. (→P.124)

■ **Passcode has not been entered on the cellular phone.**

Enter the passcode on the cellular phone if requested (default passcode: 1234).

■ **Transfer operation on the cellular phone has not completed.**

Complete transfer operation on the cellular phone (approve transfer operation on the phone).

Phonebook data cannot be edited.

■ **Automatic contact transfer function on this system is set to on.**

Set automatic contact transfer function on this system to off. (→P.124)

When using the Bluetooth® message function

Messages cannot be viewed.

- **Message transfer is not enabled on the cellular phone.**

Enable message transfer on the cellular phone (approve message transfer on the phone).

- **Automatic transfer function on this system is set to off.**

Set automatic transfer function on this system to on. (→P.124)

New message notifications are not displayed.

- **Notification of SMS/MMS/E-mail reception on this system is set to off.**

Set notification of SMS/MMS/E-mail reception on this system to on. (→P.123)

- **Automatic message transfer function is not enabled on the cellular phone.**

Enable automatic transfer function on the cellular phone.

In other situations

The Bluetooth® connection status is displayed at the top of the screen each time the system is activated.*

- **Connection confirmation display on this system is set to on.**

To turn off the display, set connection confirmation display on this system to off. (→P.37)

*: The engine switch is in ACC or ON.

Even though all conceivable measures have been taken, the symptom status does not change.

- **The cellular phone is not close enough to this system.**

Bring the cellular phone closer to this system.

- **Radio interference has occurred.**

Turn off Wi-Fi® devices or other devices that may emit radio waves.

- **The cellular phone is the most likely cause of the symptom.**

Turn the cellular phone off, remove and reinstall the battery pack, and then restart the cellular phone.

Enable the cellular phone's Bluetooth® connection.

Disable the Wi-Fi® connection of

the cellular phone.

Stop the cellular phone's security software and close all applications.

Before using an application installed on the cellular phone, carefully check its source and how its operation might affect this system.

-
- For details, refer to the owner's manual that came with the cellular phone.

Index

135

Alphabetical Index **136**

Alphabetical Index

A

Android Auto	42, 72
“Android Auto” button (“Menu” screen)	13, 42
Apple CarPlay	42
“Apple CarPlay” button (“Menu” screen)	13, 42
Audio	
Audio source	57
Operating information	81
Reordering the audio source.....	58
Screen adjustment.....	59
Some basics	57
Sound settings	58
Speech command system.....	61
Turning the system on and off.....	57
USB port	58
“Audio” button (“Menu” screen)...	13
“Audio” button (“Setup” screen) ..	16
“AUDIO” button	56
Audio settings	80
Common settings	80
Audio source	57

B

Bluetooth® audio	73
Registering/Connecting a Bluetooth® device	75
“Bluetooth” button (“Setup” screen)	16
Bluetooth® details settings	32
Bluetooth® setup screen	32
Connecting a Bluetooth® device ..	33
Deleting a Bluetooth® device	35
“Detailed settings” screen	37
Displaying the Bluetooth® setup screen	32
Editing the Bluetooth® device infor-	

mation	35
Registering a Bluetooth® device ..	34
Bluetooth® device information	35
Bluetooth® hands-free system	106
Bluetooth® phone message function	117
Calling the message sender.....	120
Checking received messages	118
Checking sent messages	119
Create new message	119
Displaying the message screen .	117
Receiving a message.....	118
Replying to a message (quick reply)	120

C

Clock settings	50
Command list	92
Connecting to internet/Miracast® via Wi-Fi®	
Displaying the Wi-Fi® settings screen	39
Operating hints	40
Connecting to Miracast® via Wi-Fi® ..	39
Wi-Fi® settings screen	39

D	
DAB	62
“Display” button (“Menu” screen)	13

E	
Entering letters and numbers/list screen operation	22
Entering letters and numbers.....	22
List screen.....	24

F	
FM	62

G	
“General” button (“Setup” screen)	16, 49
General settings	49
Displaying the general settings screen	49
General settings screen	49

H	
Hands-free system	106
Home screen operation	21

I	
Initial screen	18
Caution screen	18
Restarting the system	18
iPod/iPhone	69

L	
Linking multi-information display and the system	27



M	
“MENU” button	13
“Menu” screen	13
Menu screen operation	13
Microphone	108
Miracast®	76
Connecting a Miracast® device.....	77

P	
Phone	106
About the contacts in the contact list	110
Phone screen operation.....	106
Registering/Connecting a Blue-tooth® phone.....	108
Some basics	107
Speech command system.....	110
Troubleshooting	131
When selling or disposing of the vehicle	110
“Phone” button (“Menu” screen)..	13
“Phone” button (“Setup” screen).	16
“PHONE” button	106
Phone settings	122
Contact/Call history settings	124
Message settings	129
Notifications settings	123
Sounds settings	122
Toyota assistance settings	130
Placing a call using the Bluetooth® hands-free system	111
By call history.....	111
By contacts list.....	112
By favourites list.....	112
By home screen	114
By keypad	113
SOS	113
“POWER VOLUME” knob	57

R	
Radio	62
RDS (Radio data system)	65
Rear view monitor system	96
Camera	98
Differences between the screen and the actual road	99
Driving precautions	96
Precautions	98
Screen description	97
Things you should know.....	102
When approaching three-dimensional objects	100
Receiving a call using the Bluetooth® hands-free system	115
Registering/Connecting a Bluetooth® device	28
Profiles	31
Registering a Bluetooth® audio player for the first time	30
Registering a Bluetooth® phone for the first time	28

S

Screen adjustment 25
“Setup” button (“Menu” screen). 13, 16
“Setup” screen 16
Speech command system 90
 Speech command system operation 91
 Using the speech command system 90
Status icon 14
 Status icon explanation 14
Steering switch 79, 90
 Audio switch 79
 Talk switch 90
 TEL switch 108

T

Talking on the Bluetooth® hands-free system 115
 Call screen operation 115
 Incoming call waiting 117
 Sending tones 116
 Switching calls while a call is in progress 116
 Transmit volume setting 116
Touch screen 19
 Touch screen gestures 19
 Touch screen operation 20

U

USB memory 67
USB port 58

V

“Vehicle” button (“Setup” screen) 16, 53
Vehicle settings 53
 Displaying the vehicle settings screen 53
 Setting the valet mode 53
 Valet mode setting 53
 Vehicle settings screen 53
“Voice” button (“Setup” screen) .16, 52
Voice settings 52
 Displaying the voice settings screen 52
 Voice settings screen 52

W

Wi-Fi® 39
Wi-Fi® button (“Setup” screen) 16, 39

For more information about the following items, see the “Owner’s Manual”.

- Fuel consumption
- Vehicle customisation settings

**Toyota Motor Europe NV/SA,
Avenue du Bourget 60 - 1140
Brussels, Belgium www.toyota-europe.com**

**Toyota (GB) PLC Great Burgh,
Burgh Heath, Epsom, Surrey,
KT18 5UX, UK.**



Certification

<p>Manufacturer •Name: Panasonic Corporation</p> <p>•Address: 4261 Ikonobe-cho, Tsuzuki-ku, Yokohama-shi, Kanagawa-ken, 224-8520, Japan</p>
<p>Specifications of Bluetooth Frequency band: 2402-2480MHz Maximum radio-frequency power: 2.5mW Max</p>
<p>Specifications of WLAN Frequency band: 2412-2472MHz Maximum radio-frequency power: 100mW Max</p>
<p>Model No.[*] CV-RS1CE0AE,CV-RS1CE1AE,CV-RS1CE2AE,CV-RS1CE3AE</p>

<p>Hereby, Panasonic Corporation declares that the radio equipment type [*] is in compliance with Directive 2014/53/EU. The full text of the EU declaration of conformity is available at the following internet address: http://www.ptc.panasonic.eu/</p>

<p>С настоящото Panasonic Corporation декларира, че този тип радиосъоръжение [*] е в съответствие с Директива 2014/53/ЕС. Цялостният текст на ЕС декларацията за съответствие може да се намери на следния интернет адрес: http://www.ptc.panasonic.eu/</p>
<p>Tímto Panasonic Corporation prohlašuje, že typ rádiového zařízení [*] je v souladu se směrnicí 2014/53/EU. Úplné znění EU prohlášení o shodě je k dispozici na této internetové adrese: http://www.ptc.panasonic.eu/</p>
<p>Hermed erklærer Panasonic Corporation, at radioudstyrstypen [*] er i overensstemmelse med direktiv 2014/53/EU. EU-overensstemmelseserklæringens fulde tekst kan findes på følgende internetadresse: http://www.ptc.panasonic.eu/</p>
<p>Hiermit erklärt Panasonic Corporation, dass der Funkanlagentyp [*] der Richtlinie 2014/53/EU entspricht. Der vollständige Text der EU-Konformitätserklärung ist unter der folgenden Internetadresse verfügbar: http://www.ptc.panasonic.eu/</p>
<p>Käesolevaga deklareerib Panasonic Corporation, et käesolev raadioseadme tüüp [*] vastab direktiivi 2014/53/EL nõuetele. ELi vastavusdeklaratsiooni täielik tekst on kättesaadav järgmisel internetiaadressil: http://www.ptc.panasonic.eu/</p>
<p>Με την παρούσα ο/η Panasonic Corporation, δηλώνει ότι ο ραδιοεξοπλισμός [*] πληροί την οδηγία 2014/53/ΕΕ. Το πλήρες κείμενο της δήλωσης συμμόρφωσης ΕΕ διατίθεται στην ακόλουθη ιστοσελίδα στο διαδίκτυο: http://www.ptc.panasonic.eu/</p>

<p>Por la presente, Panasonic Corporation declara que el tipo de equipo radioeléctrico [*] es conforme con la Directiva 2014/53/UE. El texto completo de la declaración UE de conformidad está disponible en la dirección Internet siguiente: http://www.ptc.panasonic.eu/</p>
<p>Le soussigné, Panasonic Corporation, déclare que l'équipement radioélectrique du type [*] est conforme à la directive 2014/53/UE. Le texte complet de la déclaration UE de conformité est disponible à l'adresse internet suivante: http://www.ptc.panasonic.eu/</p>
<p>Il fabbricante, Panasonic Corporation, dichiara che il tipo di apparecchiatura radio [*] è conforme alla direttiva 2014/53/UE. Il testo completo della dichiarazione di conformità UE è disponibile al seguente indirizzo Internet: http://www.ptc.panasonic.eu/</p>
<p>Ar šo Panasonic Corporation deklarē, ka radioiekārta [*] atbilst Direktīvai 2014/53/ES. Pilns ES atbilstības deklarācijas teksts ir pieejams šādā interneta vietnē: http://www.ptc.panasonic.eu/</p>
<p>Aš, Panasonic Corporation, patvirtinu, kad radijo įrenginių tipas [*] atitinka Direktyvą 2014/53/ES. Visas ES atitikties deklaracijos tekstas prieinamas šiuo interneto adresu: http://www.ptc.panasonic.eu/</p>
<p>Panasonic Corporation ovime izjavljuje da je radijska oprema tipa [*] u skladu s Direktivom 2014/53/EU. Cjeloviti tekst EU izjave o sukladnosti dostupan je na sljedećoj internetskoj adresi: http://www.ptc.panasonic.eu/</p>

<p>Panasonic Corporation igazolja, hogy a [*] típusú rádióberendezés megfelel a 2014/53/EU irányelvnek. Az EU-megfelelőségi nyilatkozat teljes szövege elérhető a következő internetes címen: http://www.ptc.panasonic.eu/</p>
<p>B'dan, Panasonic Corporation, niddikjara li dan it-tip ta' tagħmir tar-radju [*] huwa konformi mad-Direttiva 2014/53/UE. It-test kollu tad-dikjarazzjoni ta' konformità tal-UE huwa disponibbli f'dan l-indirizz tal-Internet li ġejj: http://www.ptc.panasonic.eu/</p>
<p>Hierbij verklaar ik, Panasonic Corporation, dat het type radioapparatuur [*] conform is met Richtlijn 2014/53/EU. De volledige tekst van de EU-conformiteitsverklaring kan worden geraadpleegd op het volgende internetadres: http://www.ptc.panasonic.eu/</p>
<p>Panasonic Corporation niniejszym oświadcza, że typ urządzenia radiowego [*] jest zgodny z dyrektywą 2014/53/UE. Pełny tekst deklaracji zgodności UE jest dostępny pod następującym adresem internetowym: http://www.ptc.panasonic.eu/</p>
<p>O(a) abaixo assinado(a) Panasonic Corporation declara que o presente tipo de equipamento de rádio [*] está em conformidade com a Diretiva 2014/53/UE. O texto integral da declaração de conformidade está disponível no seguinte endereço de Internet: http://www.ptc.panasonic.eu/</p>
<p>Prin prezenta, Panasonic Corporation declară că tipul de echipamente radio [*] este în conformitate cu Directiva 2014/53/UE. Textul integral al declarației UE de conformitate este disponibil la următoarea adresă internet: http://www.ptc.panasonic.eu/</p>

<p>Panasonic Corporation týmto vyhlasuje, že rádiové zariadenie typu [*] je v súlade so smernicou 2014/53/EÚ. Úplné EÚ vyhlásenie o zhode je k dispozícii na tejto internetovej adrese: http://www.ptc.panasonic.eu/</p>
<p>Panasonic Corporation potvrdzuje, da je tip radijske opreme [*] skladden z Direktivo 2014/53/EU. Celotno besedilo izjave EU o skladnosti je na voljo na naslednjem spletnem naslovu: http://www.ptc.panasonic.eu/</p>
<p>Panasonic Corporation vakuuttaa, että radiolaitetyyppi [*] on direktiivin 2014/53/EU mukainen. EU-vaatimustenmukaisuusvakuutuksen täysimittainen teksti on saatavilla seuraavassa internetosoitteessa: http://www.ptc.panasonic.eu/</p>
<p>Härmed försäkrar Panasonic Corporation att denna typ av radioutrustning [*] öoverensstämmer med direktiv 2014/53/EU. Den fullständiga texten till EU-försäkran om överensstämmelse finns på följande webbadress: http://www.ptc.panasonic.eu/</p>

<p>Manufacturer</p> <ul style="list-style-type: none">• Name : Panasonic Corporation• Address : 4261 Ikonobe-cho, Tsuzuki-ku, Yokohama-shi, Kanagawa-ken, 224-8520, Japan
<p>Specifications of Bluetooth</p> <p>Frequency band : 2402-2480MHz</p> <p>Maximum radio-frequency power : 2.5mW Max</p>
<p>Specifications of WLAN</p> <p>Frequency band : 2412-2472MHz</p> <p>Maximum radio-frequency power : 100mW Max</p>
<p>Model No.[*]</p> <p>[type of equipment]</p> <p>CV-RS1CE0AE,CV-RS1CE1AE,CV-RS1CE2AE,CV-RS1CE3AE</p>

<p>Hereby, Panasonic Corporation declares that the radio equipment type [*] is in compliance with No1206 The Radio Equipment Regulation 2017.</p> <p>The full text of UK declaration of conformity is available at the following internet address:</p> <p>http://www.ptc.panasonic.eu/</p>

 Access to <http://www.ptc.panasonic.eu/>, enter the below Model No. into the keyword search box, you can download the latest "DECLARATION of CONFORMITY" (DoC).

Model No.[*]
CV-RS1CE0AE,CV-RS1CE1AE,CV-RS1CE2AE,
CV-RS1CE3AE

רושקתה דרשמ םעטמ המאתה רושיא רפסמ:55-12988

ויתונכות תא תונשל ידכ ןהב שיש רישכמב תולועפ עצבל רוסיא לח רישכמה לש תויטוחלאה, הנכות ייוניש הז ללכבו, וא תירוקמ הנטנא תפלחה תינוציח הנטנאל רוביחל תורשפא תפסוה, תרושקתה דרשמ רושיא תלבק אלב, תויטוחלא תוערפהל ששחה לשב.